

Sagi

- [EN]** Refrigeration
- [DE]** Kühlgeräte
- [ES]** Refrigeración
- [FR]** Réfrigération
- [IT]** Refrigerazione
- [PL]** Chłodnictwo
- [RU]** Холодильная техника

✉ gastroparts@gastroparts.com

☎ +48 56 657 00 66



📘 fb.com/gastroparts.global





			
Part No.	419109	Ref. No.	32G1810
description	heating cable 150W 220V L1 (unheated) 2x1000mm L2 (heated) 5000mm ø 3.5mm L 7000mm connection male faston 6.3mm		
For models:	F120B, IMP202R, IMR201R, IMR202R, N135B, N135BPS, P135, P135-3, P135-4, P135B, SX120, SX120B, SX120PV, SX135, SX135-3, SX135-4, SX135B, SX135B-3, SX135B-4, SX135BAX, SX135BE, SX135BR, SX135ES, SX135PV, SX135R		

heating cartridges

			
Part No.	418892	Ref. No.	32G3310
description	heating cartridge 300W 230V ø 12mm L 240mm thread 3/8" cable length 2000mm immersion heater		
For models:	AS120, AS120BN, AS120NN, AS140, AS140BN, AS140NN, AS150, AS55, AS65, AS70, AX120, AX120BN, AX120NN, AX130, AX130NN, AX140, AX140BN, AX140NN, AX150, AX150NN, AX55, AX60, AX65, AX70, CD150R, CD70BR, CD70R, DMG102, DMG102-0P141, DMG82, DMG82-0P141, FD150, FD150LT, FD70, FD70LT, GS120, GS120BN, GS120NN, GS130, GS130NN, GS140, GS140BB, GS140BN, GS140BN2, GS140BR, GS140CP, GS140NCP, GS140NN, GS140PV, GS140R...(Other models you can see in the webshop)		
accessories for	418892		
	Part No.	511472	Ref. No. —
	nut thread 3/8" H 4mm brass WS 21 Qty 1 pcs		
	Part No.	518393	Ref. No. —
	flat gasket FIBER ED ø 24mm ID ø 17mm thickness 2mm Qty 1 pcs		

thermostats

refrigeration thermostats

universal without housing

			
Part No.	390534	Ref. No.	32Z1090 32Z6310 32Z7110
description	thermostat temperature range -35 up to +35°C probe ø6x110mm capillary pipe 1800mm PRODIGY		
For models:	AM03LT7, AM03LT7A, AM03LT7M, AM1LM, AM1LT, AM1LT7, AM1LT7A, AM1LT7M, AS120B, AS120BN, AS140B, AS140BN, AS150B, AS55B, AS65B, AS70B, AT1L, AX120B, AX120BN, AX130B, AX140B, AX140BN, AX150B, AX55B, AX60B, AX65B, AX70B, CD70BPV, DMG51ME, E1200B, E1200B4, E1200BE, E125B, E125B-4, E125BE, E125BPL, E125BPLE, E125BX, E125BX-4, E125BXE, E600B, E600B2, E600BE, E60B, E60B-2, E60BE, E60BPL, E60BPLE, E60BX, E60BX-2...(Other models you can see in the webshop)		
accessories for	390534		
	Part No.	110305	Ref. No. —
	knob thermostat t.max. 35°C temperature range -35 up to +35°C ø 45mm shaft ø 6x4.6mm shaft flat inclined rotation 270° white		

RANCO

K22 series

			
Part No.	390209	Ref. No.	32V2280 32V4360
description	thermostat RANCO type K22-L1020 probe ø 9mm probe L 40mm capillary pipe 2000mm temperature range -20.5 up to -1.5°C		

K50 series

			
Part No.	390278	Ref. No.	32Z6360
description	thermostat RANCO type K50-L3207 probe ømm probe Lmm capillary pipe 1500mm temperature range -10 up to -2°C		
For models:	EKP, EKP218, EKP21C, EKPV, EKV, EKV218, EKV21C, EKVW, SKP, SKP218, SKP21C, SKPV, SKV, SKV218, SKV21C, SKVW		

K52 series

			
Part No.	390214	Ref. No.	32Z0920
description	thermostat RANCO type K52-L4512 probe ø 11mm probe L 30mm capillary pipe 2100mm temperature range -6.4 up to +3.2°C		
For models:	F40EVP, F40PLA, F40PLE, F40PLPV		



switches and momentary switches

rocker/momentary rocker switches

25.5x25mm



Part No.	345278 ¹	Ref. No.	32W0990 32W3970
description	rocker switch mounting measurements 25.5x25mm green 2NO 250V 16A illuminated 0-I connection male faston 6.3mm protection IP40		
For models:	AS120, AS120B, AS120BN, AS120NN, AS140, AS140B, AS140BN, AS140NN, AS150, AS150B, AS55, AS55B, AS65, AS65B, AS70, AS70B, AX120, AX120B, AX120BN, AX120NN, AX130, AX130B, AX130NN, AX140, AX140B, AX140BN, AX140NN, AX150, AX150B, AX150NN, AX55, AX55B, AX60, AX60B, AX65, AX65B, AX70, AX70B, CD130, CD130B, CD130BN, CD130NN, CD150, CD150B, CD150BB, CD150BN, CD150BR, CD150CP, CD150NN, CD150PV...(Other models you can see in the webshop)		
accessories for	345278		
	Part No.	301323	Ref. No. 36C5180
	protective cover external size 35x35mm H 11mm transparent suitable for rocker switch mounting measurements 25.5x25mm L 35mm W 35mm		

¹illuminated

30x22mm

labelled



Part No.	300125	Ref. No.	32W2331 32W2990
description	rocker switch mounting measurements 30x22mm green 2NO 230V 16A 0-I connection male faston 6.3mm ambient temperature max. 125/55°C protection IP65 with cover cap		
For models:	AM1LM, AT1L, E125, E125-4, E125B, E125B-4, E125BE, E125BPL, E125BPLE, E125BX, E125BX-4, E125BXE, E125E, E125PL, E125PLE, E125PV, E125PVX, E125SP, E125X, E125X-4, E125XE, E125XSP, E60, E60-2, E60B, E60B-2, E60BE, E60BPL, E60BPLE, E60BX, E60BX-2, E60BXE, E60E, E60PL, E60PLE, E60PV, E60PVX, E60SP, E60X, E60X-2, E60XE, E60XSP, EKP, EKP218, EKP21C, EKPV, EKV, EKV218, EKV21C, EKVV...(Other models you can see in the webshop)		
accessories for	300125		
	Part No.	301036	Ref. No. —
	protective cover internal size 30x22mm for rocker switch mounting measurementsmm		



Part No.	345275	Ref. No.	32W3190
description	rocker switch mounting measurements 30x22mm white 1CO/indicator light 230V 16A 1-2 connection male faston 6.3mm ambient temperature max. 125/55°C protection IP65 with cover cap		
For models:	F120, F120NN, F120PL, F120PV, F120SP, F55, F55PL, F55PV, F55SP, KM1A, KM1A-11, KM1A-11A, KM1A-11X, KM1A-2, KM1A-2A, KM1A-2X, KM1A-4, KM1A-4A, KM1A-4X, KM1A-A, KM1A-X, KM1B, KM1B-11, KM1B-11A, KM1B-11X, KM1B-2, KM1B-22, KM1B-22A, KM1B-22X, KM1B-2A, KM1B-2X, KM1B-4, KM1B-4A, KM1B-4X, KM1B-6, KM1B-6A, KM1B-6X, KM1B-A, KM1B-X, KM1C, KM1C-11, KM1C-11A, KM1C-11X, KM1C-2, KM1C-2A, KM1C-2X, KM1C-4, KM1C-4A, KM1C-4X, KM1C-6...(Other models you can see in the webshop)		

accessories

protective covers



Part No.	301323	Ref. No.	36C5180
description	protective cover external size 35x35mm H 11mm transparent suitable for rocker switch mounting measurements 25.5x25mm L 35mm W 35mm		

microswitches

lever actuated



Part No.	345254	Ref. No.	32W1320
description	microswitch with lever 250V 16A 1CO connection male faston 6.3mm ambient temperature max. 120°C mounting distance 22mm actuating force: 60g lever length 58mm		
For models:	E125, E125-4, E125B, E125B-4, E125BE, E125BPL, E125BPLE, E125BX, E125BX-4, E125BXE, E125E, E125PL, E125PLE, E125PV, E125PVX, E125SP, E125X, E125X-4, E125XE, E125XSP, E60, E60-2, E60B, E60B-2, E60BE, E60BPL, E60BPLE, E60BX, E60BX-2, E60BXE, E60E, E60PL, E60PLE, E60PV, E60PVX, E60SP, E60X, E60X-2, E60XE, E60XSP, F120, F120B, F120NN, F120PL, F120PV, F120SP, F40, F40CP, F40CPX, F40PLA...(Other models you can see in the webshop)		

pin-plunger actuated

M12



Part No.	345360	Ref. No.	32W1410
description	microswitch with plunger mounting distance 25.4mm thread M12x1 thread L 15mm 250V 10A 1CO connection screw stroke 5mm ambient temperature max. 125°C type Highly D5000 actuating force: 200g		
For models:	SX65CPB		



with push button			
switches with snap-fit			
			
1			
Part No.	347027	Ref. No.	32W3770
description	microswitch with push button 250V 1A 1CO connection male faston 2.8mm L 26x12mm ambient temperature max. 85°C type XKA-304B1AAJ11 actuating force: 50g		
For models:	AS120, AS120B, AS120BN, AS120NN, AS140, AS140B, AS140BN, AS140NN, AS150, AS150B, AS55, AS55B, AS65, AS65B, AS70, AS70B, AX120, AX120B, AX120BN, AX120NN, AX130, AX130B, AX130NN, AX140, AX140B, AX140BN, AX140NN, AX150, AX150B, AX150NN, AX55, AX55B, AX60, AX60B, AX65, AX65B, AX70, AX70B, E1200, E1200A, E1200B, E1200B4, E1200BE, E1200E, E1200PV, E600, E6002, E600B, E600B2, E600BE...(Other models you can see in the webshop)		

			
2			
Part No.	348008	Ref. No.	3096020
description	microswitch with push button 250V 5A 1NO/1NC connection male faston 2.8mm/6.3mm L 27mm L1 22mm ambient temperature max. 104°C actuating force: 180g		
For models:	CD130, CD130B, CD130BN, CD130NN, CD150, CD150B, CD150BB, CD150BN, CD150BR, CD150CP, CD150NN, CD150PV, CD150R, CD60, CD60B, CD70, CD702, CD70B, CD70B2, CD70BPV, CD70BR, CD70CP, CD70PV, CD70PVXS, CD70R, CDG150, CDG150B, CDG70, CDG70B, CDPT, CDRI, F40-OP141, F40CP, F40CP-OP141, F40CPX-OP141, F40PV-OP141, F40X-OP141, FD150, FD150B, FD150BT, FD150LT, FD150LTE, FD150T, FD70, FD70B, FD70BT, FD70LT, FD70LTE, FD70T, HD130...(Other models you can see in the webshop)		

magnetic switches

M10x0.75			
			
1			
Part No.	348024	Ref. No.	32w1890 32w3460
description	magnetic switch 1NO 250V 1A P max. 10W connection Faston 6.3mm cable length 2000mm		
For models:	AM14SR, AM1L, AM1L7, AM1L7A, AM1L7M, AM1LR, AM1LW, AM2L, AM2LR, AM2LW, AM2S, AM2SR, AM2SW, AM3S, AM3SR, AM3SW, AM4S, AM4SR, AM4SW, AM7SR, DM101L, DM31, DM31A, DM31M, DM51, DM51A, DM51C, DM51M, DM51ME, DMG101L, DMG51C, DMG51M, DMG51ME-OP141, DMS101L, DMS101S, DMS102S, DMS51, DMS51A, DMS51C, DMS51M, DMS72S, GS65BCP, GS65NB, GS65NCP, GS65NN, IM101L, IM101LR, IM101LW, IM101RAT, IM101S...(Other models you can see in the webshop)		

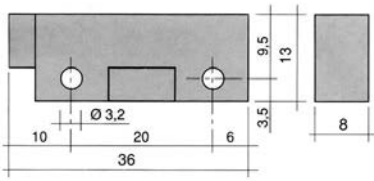
accessories			
magnets			
 			
1			
Part No.	345398	Ref. No.	32V0080
description	magnet ømm L 36mm H 8mm W 13mm hole distance 20mm M3 hole ø 3mm		

lamps

indicator lights

indicator lights (complete)			
ø10mm			
with screw socket			
			
1			
Part No.	359378	Ref. No.	32W1330
description	indicator light ø 10mm 230V green connection male faston 6.3mm socket screw base		
For models:	ECB, ECB218, ECN, ECN218, ENB, ENB218, ENB75, KA12A1E, KA12B1E, KA12B2E, KA12M1E, KA14A1E, KA14B1E, KA14B2E, KA14M1E, KA16A1E, KA16B1E, KA16B2E, KA16M1E, KA18A1E, KA18B1E, KA18B2E, KA18M1E, KA20A1E, KA20B1E, KA20B2E, KA20M1E, KAJ12AE, KAJ12ME, KAJ14AE, KAJ14ME, KAJ16AE, KAJ16ME, KAJ18AE, KAJ18ME, KAJ20AE, KAJ20ME, QE14VB, QE21VB, QI14VB, QI21VB, QL14CPN, QL14CVB, QL14NVB, QL21CPN, QL21CVB, QL21NVB, QL7NVB, SVB, SVB218		

30x22mm			
			
1			
Part No.	359156	Ref. No.	32W0270
description	indicator light mounting measurements 30x22mm 230V yellow connection male faston 6.3mm temp.-resist. 125/55°C type RL2		



fridge lamps



1

Part No.	359595	Ref. No.	32W3790
description	light bulb socket E14 15W 230-240V ø 25mm L 56mm lens L 30mm Qty 1 pcs		
For models:	AS120, AS120B, AS120BN, AS120NN, AS140, AS140B, AS140BN, AS140NN, AS55, AS55B, AS65, AS65B, AX120, AX120B, AX120BN, AX120NN, AX140, AX140B, AX140BN, AX140NN, AX55, AX55B, AX65, AX65B, CD130, CD130B, CD130BN, CD130NN, CD150, CD150B, CD150BB, CD150BN, CD150BR, CD150CP, CD150NN, CD150R, CD60, CD60B, CD70, CD702, CD70B, CD70B2, CD70BR, CD70CP, CD70R, CDG150B, CDPT, CDRI, DMG102-0P141, DMG82-0P141...(Other models you can see in the webshop)		



1

Part No.	360379	Ref. No.	32Z4760
description	timer CDC 9003F engines 1 chambers 3 operation time 240s 230V shaft ø 6x4.6mm shaft L 20mm manuf. no. 9003F1 / 32Z4760 motor type M48R ATS		
spare parts for	360379		
	Part No.	360118	Ref. No. —
	motor CDC pinion ø 4.9mm teeth 10 230V voltage AC 50/60Hz turn direction right motor ø 47mm H 19.3mm motor type M48R ATS for timer cable length 260mm 1.9/2.5W		

timers

programme timers

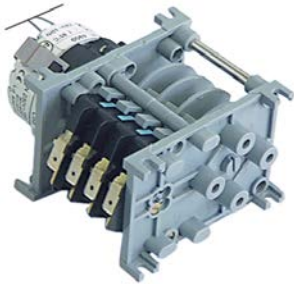



1

Part No.	360196	Ref. No.	32Z0780
description	timer CDC 4904F engines 1 chambers 4 operation time 60s 230V manuf. no. 4904F3 / 3322060 motor type M48L BTN		



1

Part No.	360215	Ref. No.	32V1940
description	timer CDC 7805DV engines 2 chambers 5 operation time 6s / 3min 230V shaft ømm shaft Lmm motor type M37RN/M37LN		
spare parts for	360215		
	Part No.	360119	Ref. No. —
	motor CDC pinion ø 5.4mm teeth 12 230V turn direction right motor ø 37mm motor type M37RN for timer		
	Part No.	360131	Ref. No. —
	motor CDC pinion ø 5.4mm teeth 12 230V turn direction left motor ø 37mm motor type M37LN for timer		



1

Part No.	360392	Ref. No.	3175700
description	timer FIBER P25 engines 2 chambers 5 operation time 60s / 3min 230V shaft ømm shaft Lmm		

defrost timers

BIGATTI



1

Part No.	360058	Ref. No.	32Z7100
description	defrost timer type SB3.82 defrosting interval 1-12x in 24h defrosting time 2-54min fan delay 0-15min 230V defr. funct. 1-12x per 24h		
For models:	F40CP, N65NN, SX65CPN, SX65NN		



CDC



1

Part No.	360521	Ref. No.	32Z2421
description	defrost timer CDC type 11901F defrosting interval 4x per 24h defrosting time 12min fan delaymin 230V 50-60Hz defr. funct. every 6h		
For models:	F120NN, F120PV, F120SP, F55SP, K160PS, K200PS, N135, N135-3, N135-4, N135BN, N135NN, N135PS, N135PV, N65, N65-2, N65GT, N65PS, N65PV, SX120NN, SX135NN, SX135NN2M, SX65N-3C		



1

Part No.	360384	Ref. No.	32Z5731
description	defrost timer CDC type 11901F defrosting interval 4x per 24h fan delaymin 230V		
For models:	EM1B, EM1B-2, EM1B-2A, EM1B-2X, EM1B-4, EM1B-4A, EM1B-4X, EM1B-A, EM1B-X, EM1C, EM1C-2, EM1C-2A, EM1C-2X, EM1C-4, EM1C-4A, EM1C-4X, EM1C-6, EM1C-6A, EM1C-6X, EM1C-A, EM1C-X, EXM1B, EXM1B-2, EXM1B-2A, EXM1B-2X, EXM1B-4, EXM1B-4A, EXM1B-4X, EXM1B-A, EXM1B-X, EXM1C, EXM1C-2, EXM1C-2A, EXM1C-2X, EXM1C-4, EXM1C-4A, EXM1C-4X, EXM1C-6, EXM1C-6A, EXM1C-6X, EXM1C-A, EXM1C-X, K100, K100SL, K100SLV, K100X, K100XA, SX135-3E, SX135-4E, SX65-2E...(Other models you can see in the webshop)		

contactors

SIEMENS

power contactors



1

Part No.	380646	Ref. No.	32Z9250
description	power contactor resistive load 40A 230VAC (AC3/400V) 17A/7.5kW main contacts 3NO auxiliary contacts connection screw connection type 3RT10-25-1AL20		
For models:	AF1L, AF1L7, AF1L7A, AF1L7M, AF2L, AF2S, AF3S, AM1L, AM1L7, AM-1L7A, AM1L7M, AM1LR, AM1LT, AM1LT7, AM1LT7A, AM1LT7M, AM-1LW, AM2L, AM2LR, AM2LW, AM2S, AM2SR, AM2SW, AM3S, AM3SR, AM3SW, AT1L7, AT1L7A, AT1L7M, DM101L, DM51, DM51A, DM51C, DM51M, DMG101L, DMG102, DMG102-OP141, DMG51C, DMG51M, DMG82, DMG82-OP141, DMS101L, DMS101S, DMS102S, DMS51, DMS51A, DMS51C, DMS51M, DMS72S, GR135BT...(Other models you can see in the webshop)		

relays

power relays

with bracket mounting



1

Part No.	380139	Ref. No.	32Z2000
description	power relays FINDER 230VAC 16A 2CO connection F6.3 bracket mounting dimensions 68x38.2x35.8mm manuf. no. 62.82.8.230.0000		



1

Part No.	380185	Ref. No.	32V3720
description	power relays Italiana Relè 230VAC 30A 1NO connection F6.3 bracket mounting dimensions 36.5x32.2x51.8mm manuf. no. A10-230AC-FA		
For models:	AM03LT7, AM03LT7A, AM03LT7M, AS120B, AS120BN, AS140B, AS140BN, AS150B, AS55B, AS65B, AS70B, AT1L, AT1L7, AT1L7A, AT1L7M, AX120B, AX120BN, AX130B, AX140B, AX140BN, AX150B, AX55B, AX60B, AX65B, AX70B, CD130B, CD130BN, CD150B, CD150BB, CD150BN, CD150BR, CD60B, CD70B, CD70B2, CD70BPV, CD70BR, CDG150B, CDG70B, DM31, DM31A, DM31C, DM31M, DM51ME, DMG-51ME, DMG51ME-OP141, DR51, DR51A, DR51M, E1200B, E1200B4...(Other models you can see in the webshop)		

transformers

open transformers

with plug connection



1

Part No.	400956	Ref. No.	32V5770
description	transformer primary 230VAC secondary 12VAC 20VA connection male faston 6.3mm 50/60Hz type T602012/E temperature restriction 150°C ambient temperature max. 80°C		
For models:	IF101L, IF51M		



encapsulated transformers

PMA



1			
Part No.	379054	Ref. No.	32Z3470
description	transformer primary 230VAC secondary 12VAC 3VA secondary 0.25A H 40mm L 45mm W 50mm connection screw 50/60Hz type 153/M		
For models:	AM1LM, E125B, E125B-4, E125BE, E125BPL, E125BPLe, E125BX, E125BX-4, E125BXE, E125SP, E125XSP, E60B, E60B-2, E60BE, E60BPL, E60BPLe, E60BX, E60BX-2, E60BXE, E60SP, E60XSP, EKP, EKP218, EKP21C, EKPV, EKV, EKV218, EKV21C, EKV, F120, F120B, F120PL, F120PV, F40CP, F40CPX, F55, F55B, F55PL, F55PV, FD140, FD140B, FD140NN, FD140PV, FD65, FD65B, FD65PV, FDPT, FDR, HD130B, HD130BN... (Other models you can see in the webshop)		



1			
Part No.	379614	Ref. No.	32V7580
description	electronic controller ELIWELL type ID961 mounting measurements 71x29mm 230V voltage AC NTC/PTC front measurements 33x75mm protection IP65 1x NTC probe inclusive -50 up to +150°C display 3½ digit LCD 1999 Digits		
For models:	AS120, AS140, AS150, AS70, AX120, AX130, AX130NN, AX140, AX150, AX150NN, AX60, AX70		
accessories for	379614		
	Part No.	Ref. No.	32V6000
			temperature probe NTC 10kOhm cable PVC probe -20 up to +80°C cable -10 up to 100°C probe ø7x24.5mm cable length 1.5m without screw connection 2-wire
	Part No.	Ref. No.	—
			temperature probe PTC 1kOhm cable silicone probe -50 up to +150°C cable -50 up to +180°C probe ø6x40mm cable length 1.5m without screw connection 2-wire
	Part No.	Ref. No.	—
			temperature probe PTC 1kOhm cable PVC probe -50 up to +150°C cable -10 up to 100°C probe ø6x30mm cable length 3m without screw connection 2-wire
	Part No.	Ref. No.	—
			temperature probe NTC 10kOhm cable PVC probe -20 up to +80°C cable -10 up to 100°C probe ø6x25mm cable length 3m 2-wire
	Part No.	Ref. No.	8223470
			temperature probe PTC 1kOhm cable silicone probe -50 up to +150°C cable -50 up to +180°C probe ø6x40mm cable length 3m without screw connection 2-wire
	Part No.	Ref. No.	—
			temperature probe PTC 1kOhm cable PVC probe -50 up to +150°C cable -10 up to 100°C probe ø6x30mm cable length 1.5m without screw connection 2-wire
	Part No.	Ref. No.	—
			temperature probe NTC 10kOhm cable thermoplastic probe -40 up to +110°C cable -40 up to +110°C probe ø6x14mm cable length 1.5m without screw connection 2-wire
	Part No.	Ref. No.	32V6010
			temperature probe NTC 10kOhm cable thermoplastic probe -40 up to +110°C cable -40 up to +110°C probe ø6x14mm cable length 3m without screw connection 2-wire
	Part No.	Ref. No.	32V3730
			temperature probe NTC 10kOhm cable silicone probe -40 up to +110°C cable -50 up to +180°C probe ø6x40mm cable length 3m 2-wire
	Part No.	Ref. No.	—
			temperature probe NTC 10kOhm cable silicone probe -40 up to +110°C cable -50 up to +180°C probe ø6x40mm cable length 1.5m without screw connection 2-wire
	Part No.	Ref. No.	—
			temperature probe PTC 1kOhm cable thermoplastic probe -50 up to +150°C cable -40 up to +110°C probe ø6x14mm cable length 1.5m without screw connection 2-wire
	Part No.	Ref. No.	—
			temperature probe PTC 1kOhm cable thermoplastic probe -50 up to +150°C cable -40 up to +110°C probe ø6x14mm cable length 3m 2-wire resistor 1kOhm
	Part No.	Ref. No.	—
			PCB terminal block 2-pole raster size 5mm

Table continues overleaf

electronic controllers

ELIWELL

refrigeration controllers

built-in version



1			
Part No.	379114	Ref. No.	32Z3460
description	electronic controller ELIWELL type EWPC961 mounting measurements 71x29mm		



1			
Part No.	379102	Ref. No.	32Z3660
description	electronic controller ELIWELL type EWPC970 mounting measurements 71x29mm 12V relay outputs 8A		



accessories for	379614			
	Part No.	550803	Ref. No.	—
	PCB terminal block 5-pole raster size 5mm			

EVCO - EVERY CONTROL

refrigeration controllers

built-in version



1

Part No.	379232	Ref. No.	32V6500
description	electronic controller		
For models:	RX70R		

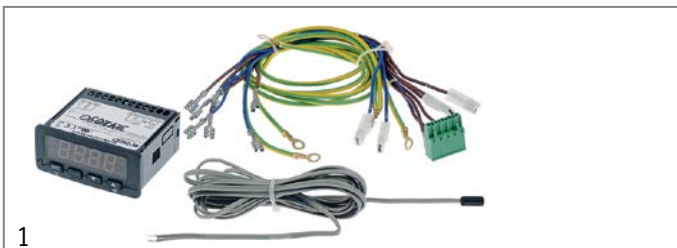

1

Part No.	381388	Ref. No.	32V2090
description	electronic controller ANGELO PO conversion kit mounting measurements 71x29mm 230V voltage AC NTC front measurements 33x75mm protection IP65 1x NTC probe inclusive -40 up to +99°C		
For models:	EM1A, EM1A-2, EM1A-2A, EM1A-2X, EM1A-A, EM1A-X, EM1B, EM1B-2, EM1B-2A, EM1B-2X, EM1B-4, EM1B-4A, EM1B-4X, EM1B-A, EM1B-X, EM1C, EM1C-2, EM1C-2A, EM1C-2X, EM1C-4, EM1C-4A, EM1C-4X, EM1C-6, EM1C-6A, EM1C-6X, EM1C-A, EM1C-X, EXM1A, EXM1A-2, EXM1A-2A, EXM1A-2X, EXM1A-A, EXM1A-X, EXM1B, EXM1B-2, EXM1B-2A, EXM1B-2X, EXM1B-4, EXM1B-4A, EXM1B-4X, EXM1B-A, EXM1B-X, EXM1C, EXM1C-2, EXM1C-2A, EXM1C-2X, EXM1C-4, EXM1C-4A, EXM1C-4X, EXM1C-6...(Other models you can see in the webshop)		



1

Part No.	379613	Ref. No.	32V2980
description	electronic controller ANGELO PO mounting measurements 71x29mm 12V voltage AC NTC front measurements 33x75mm protection IP65 2xNTC probe inclusive -40 up to +110°C		
For models:	N135B, N135BN, N135BPS, N65B, N65BPS, RX70BCP, SX120B, SX120BN, SX135B-3, SX135B-4, SX135BB, SX135BCP, SX135BN, SX-135BR, SX55B, SX65B, SX65B-2, SX65BR, SX65CPB, SX65NB		



1

Part No.	379609	Ref. No.	32V6060
description	electronic controller ANGELO PO mounting measurements 71x29mm 12V voltage AC NTC relay outputs 1 relay front measurements 33x75mm protection IP65 2xNTC probe inclusive -40 up to +99°C compressor relay 16A		
For models:	AS120B, AS120BN, AS140B, AS140BN, AS55B, AS65B, AX120B, AX120BN, AX140B, AX140BN, AX55B, AX65B, E1200B, E1200B4, E1200BE, E600B, E600B2, E600BE, GX130B, GX150B, GX60B, GX70B		



1

Part No.	379608	Ref. No.	32V6080
description	electronic controller EVERY CONTROL mounting measurements 71x29mm 12V voltage AC NTC relay outputs 1 relay front measurements 33x75mm protection IP65 2xNTC probe inclusive -40 up to +99°C compressor relay 16A		
For models:	RX150B, RX150BB, RX150BB2, RX150BN, RX150BN2, RX150BR, RX70B, RX70B-2, RX70BR		





1

Part No.	378187	Ref. No.	32V6050
description	electronic controller EVERY CONTROL mounting measurements 71x29mm 230V voltage AC NTC/PTC relay outputs 1 1CO -50 up to +150°C display 3½ digits		
For models:	GX130, GX130NN, GX150, GX150NN, GX60, GX70		



			
1			
Part No.	378192	Ref. No.	32V6900
description	electronic controller EVERY CONTROL type EVK201 mounting measurements 71x29mm 230V voltage AC NTC relay outputs 1 relay 1CO NTC defr. funct. no -50 up to +150°C display 3½ digits compressor relay 10A		
For models:	EM1A, EM1A-2, EM1A-2A, EM1A-2X, EM1A-A, EM1A-X, EM1B, EM1B-2, EM1B-2A, EM1B-2X, EM1B-4, EM1B-4A, EM1B-4X, EM1B-A, EM1B-X, EM1C, EM1C-2, EM1C-2A, EM1C-2X, EM1C-4, EM1C-4A, EM1C-4X, EM1C-6, EM1C-6A, EM1C-6X, EM1C-A, EM1C-X, EXM1A, EXM1A-2, EXM1A-2A, EXM1A-2X, EXM1A-A, EXM1A-X, EXM1B, EXM1B-2, EXM1B-2A, EXM1B-2X, EXM1B-4, EXM1B-4A, EXM1B-4X, EXM1B-A, EXM1B-X, EXM1C, EXM1C-2, EXM1C-2A, EXM1C-2X, EXM1C-4, EXM1C-4A, EXM1C-4X, EXM1C-6...(Other models you can see in the webshop)		

			
1			
Part No.	378126	Ref. No.	3087950 3107290 3120900 32V6920 32V7490 32V7820 32V8590
description	electronic controller EVERY CONTROL type EVK201N7 mounting measurements 71x29mm 230V voltage AC NTC/PTC relay outputs 1 CO-16A(5) NTC/PTC front measurements 33x75mm built-in depth 59mm protection IP65 -40 up to +105°C display 3½ digits		
For models:	AS120, AS120BN, AS120NN, AS140, AS140BN, AS140NN, AS55, AS65, AX120, AX120BN, AX120NN, AX140, AX140BN, AX140NN, AX55, AX65, F40, F40-OP141, F40PLA, F40PLE, F40PLPV, F40PV, F40PV-OP141, F40X, F40X-OP141, FD150, FD70, HD130, HD130BN, HD130NN, HD150, HD150BN, HD150NN, HD60, HD70, KAL1433, KAL1433V, KAL1437, KAL1437V, KAL1633, KAL1633V, KAL1637, KAL1637V, KAL2033, KAL2033V, KAL2037, KAL2037V, KAL2533, KAL2533V, KAL2537...(Other models you can see in the webshop)		
accessories for	378126		
	Part No.	379053	Ref. No. —
	temperature probe PTC 1kOhm cable PVC probe -50 up to +150°C cable -10 up to 100°C probe ø6x30mm cable length 3m without screw connection 2-wire		
	Part No.	379064	Ref. No. 8223470
	temperature probe PTC 1kOhm cable silicone probe -50 up to +150°C cable -50 up to +180°C probe ø6x40mm cable length 3m without screw connection 2-wire		
	Part No.	379161	Ref. No. 32V6010
	temperature probe NTC 10kOhm cable thermoplastic probe -40 up to +110°C cable -40 up to +110°C probe ø6x14mm cable length 3m without screw connection 2-wire		
	Part No.	379782	Ref. No. —
	temperature probe PTC 1kOhm cable thermoplastic probe -50 up to +150°C cable -40 up to +110°C probe ø6x14mm cable length 3m 2-wire resistor 1kOhm		

			
1			
Part No.	378154	Ref. No.	3048060 3096600 3106300 3107300 3119780
description	electronic controller EVERY CONTROL type EVK203N7VXBS mounting measurements 71x29mm 230V voltage AC NTC/PTC relay outputs 3 NO-16A(5) CO-8A(4) NO-8A(4) NTC/PTC NTC/PTC DI front measurementsmm built-in depth 59mm protection IP65 yes -50 up to +150°C display 3½ digits		
For models:	FD150LT, FD70LT, KBS11, KBS11A, KBS11M, KBS16, KBS16A, KBS16M, KBS21, KBS21A, KBS21M, KBSR11, KBSR11A, KBSR11M, KBSR16, KBSR16A, KBSR16M, KBSR21, KBSR21A, KBSR21M, KIA, KIA11, KIA11A, KIA11M, KIA13, KIA13A, KIA13M, KIA2, KIA2A, KIA2M, KIAA, KIAM, KIB, KIB11, KIB11A, KIB11M, KIB13, KIB13A, KIB13M, KIB2, KIB22, KIB22A, KIB22M, KIB2A, KIB2M, KIB4, KIB4A, KIB4M, KIBA, KIBM...(Other models you can see in the webshop)		
accessories for	378154		
	Part No.	379053	Ref. No. —
	temperature probe PTC 1kOhm cable PVC probe -50 up to +150°C cable -10 up to 100°C probe ø6x30mm cable length 3m without screw connection 2-wire		
	Part No.	379064	Ref. No. 8223470
	temperature probe PTC 1kOhm cable silicone probe -50 up to +150°C cable -50 up to +180°C probe ø6x40mm cable length 3m without screw connection 2-wire		
	Part No.	379161	Ref. No. 32V6010
	temperature probe NTC 10kOhm cable thermoplastic probe -40 up to +110°C cable -40 up to +110°C probe ø6x14mm cable length 3m without screw connection 2-wire		
	Part No.	379782	Ref. No. —
	temperature probe PTC 1kOhm cable thermoplastic probe -50 up to +150°C cable -40 up to +110°C probe ø6x14mm cable length 3m 2-wire resistor 1kOhm		

			
1			
Part No.	378189	Ref. No.	32V6290 32V6300
description	electronic controller EVERY CONTROL type EVK213 mounting measurements 71x29mm 12V voltage AC/DC NTC/PTC relay outputs 3 relays -40 up to +105°C display 3½ digits DEF Relay 8A fan relay 8A compressor relay 16A		
For models:	RX150CP, RX70NB, RX70NCP		



			
1			
Part No.	378188	Ref. No.	32V6070 32V6270
description	electronic controller EVERY CONTROL type FK203B mounting measurements 71x29mm 12V voltage AC/DC NTC relay outputs 3 relays -40 up to +99°C DEF Relay 8A fan relay 8A compressor relay 10A		
For models:	FD65PV, RX150, RX150-3, RX150-4, RX150BB, RX150BB2, RX150BN, RX150BN2, RX150CP, RX150NCP, RX150NN, RX150PV, RX150R, RX70, RX70-2, RX70PV		

			
1			
Part No.	378190	Ref. No.	32V6280
description	electronic controller EVERY CONTROL type FK203B mounting measurements 71x29mm 12V voltage AC/DC NTC relay outputs 3 relays -40 up to +99°C DEF Relay 8A fan relay 8A compressor relay 10A		
For models:	RX70NB, RX70NCP, RX70NN		

			
1			
Part No.	378191	Ref. No.	32V6260
description	electronic controller EVERY CONTROL type FK203B mounting measurements 71x29mm 12V voltage AC/DC NTC relay outputs 3 relays -40 up to +99°C DEF Relay 8A fan relay 8A compressor relay 10A		
For models:	RX150NCP		

			
1			
Part No.	378193	Ref. No.	32V2920
description	electronic controller EVERY CONTROL type FK206A mounting measurements 71x29mm 12V voltage AC/DC NTC -40 up to +99°C		
For models:	JA, JA2, JA2A, JA2M, JAA, JAM, JB, JB2, JB2A, JB2M, JB4A, JB4M, JBA, JBM		

SHANGFANG

accessories

			
1			
Part No.	379054	Ref. No.	32Z3470
description	transformer primary 230VAC secondary 12VAC 3VA secondary 0.25A H 40mm L 45mm W 50mm connection screw 50/60Hz type 153/M		
For models:	AM1LM, E125B, E125B-4, E125BE, E125BPL, E125BPLE, E125BX, E125BX-4, E125BXE, E125SP, E125XSP, E60B, E60B-2, E60BE, E60BPL, E60BPLE, E60BX, E60BX-2, E60BXE, E60SP, E60XSP, EKP, EKP218, EKP21C, EKPV, EKV, EKV218, EKV21C, EKV, F120, F120B, F120PL, F120PV, F40CP, F40CPX, F55, F55B, F55PL, F55PV, FD140, FD140B, FD140NN, FD140PV, FD65, FD65B, FD65PV, FDPT, FDR1, HD130B, HD130BN... (Other models you can see in the webshop)		

probes

universal probes

temperature probes

			
1			
Part No.	378194	Ref. No.	32V6000
description	temperature probe NTC 10kOhm cable PVC probe -20 up to +80°C cable -10 up to 100°C probe ø7x24.5mm cable length 1.5m without screw connection 2-wire		
For models:	E1200, E12004, E1200E, E1200PV, E600, E6002, E600E, E600PV, GX130, GX130NN, GX150NN, GX60, KBP41P, KBP41X, KBP53G, KBP53V, KBP53X, KBP64G, KBP64V, KBP64X, KBP83G, KBP83V, KBP83X, KBP94G, KBP94V, KBP94X, KBPZ16, KBPZ163A, KBPZ163B, KBPZ163S, KBPZ167A, KBPZ167B, KBPZ167S, KBPZ20, KBPZ203A, KBPZ203B, KBPZ203S, KBPZ207A, KBPZ207B, KBPZ207S, KBPZ25, KBPZ253A, KBPZ253B, KBPZ257A, KBPZ257B, KUA, KUA2, KUA2A, KUA2M, KUAA... (Other models you can see in the webshop)		

			
1			
Part No.	379343	Ref. No.	32V3730
description	temperature probe NTC 10kOhm cable silicone probe -40 up to +110°C cable -50 up to +180°C probe ø6x40mm cable length 3m 2-wire		
For models:	CD130, CD130B, CD130BN, CD130NN, CD150, CD150B, CD150BB, CD150BN, CD150CP, CD150NN, CD150PV, CD60, CD60B, CD70, CD702, CD70B, CD70B2, CD70BPV, CD70CP, CD70PV, CD70PV5X, CDG150, CDG150B, CDG70, CDG70B, CDPT, CDRI, DM31, DM31A, DM31C, DM31M, DM51, DM51A, DM51C, DM51M, DMG101L, DMG102, DMG102-OP141, DMG51C, DMG51M, DMG82, DMG82-OP141, DMS101L, DMS101S, DMS102S, DMS51, DMS51A, DMS51C, DMS51M, DMS72S... (Other models you can see in the webshop)		



Part No.	379161	Ref. No.	32V6010
description	temperature probe NTC 10kOhm cable thermoplastic probe -40 up to +110°C cable -40 up to +110°C probe ø6x14mm cable length 3m without screw connection 2-wire		
For models:	AS120, AS120B, AS120BN, AS120NN, AS140, AS140B, AS140BN, AS140NN, AS150, AS150B, AS55, AS55B, AS65, AS65B, AS70, AS70B, AX120, AX120B, AX120BN, AX120NN, AX130, AX130B, AX130NN, AX140, AX140B, AX140BN, AX140NN, AX150, AX150B, AX150NN, AX55, AX55B, AX60, AX60B, AX65, AX65B, AX70, AX70B, CD130, CD130B, CD130BN, CD130NN, CD150, CD150B, CD150BB, CD150BN, CD150BR, CD150CP, CD150NN, CD150PV...(Other models you can see in the webshop)		

Part No.	379064	Ref. No.	8223470
description	temperature probe PTC 1kOhm cable silicone probe -50 up to +150°C cable -50 up to +180°C probe ø6x40mm cable length 3m without screw connection 2-wire		

Part No.	379487	Ref. No.	32V0150
description	temperature probe PTC cable silicone probe -50 up to +150°C cable -50 up to +180°C probe ø6x30mm cable length 2.5m without screw connection 2-wire		
For models:	AF1L, AF1L7, AF1L7A, AF1L7M, AF2L, AF2S, AF3S, AM03LT7, AM03LT7A, AM03LT7M, AM14SR, AM1L, AM1L7, AM1L7A, AM1L7M, AM1LM, AM1LR, AM1LT, AM1LT7, AM1LT7A, AM1LT7M, AM1LW, AM2L, AM2LR, AM2LW, AM2S, AM2SR, AM2SW, AM3S, AM3SR, AM3SW, AM4S, AM4SR, AM4SW, AM7SR, AT1L, AT1L7, AT1L7A, AT1L7M, DMG51ME, DR51, DR51A, DR51M, KAF1B, KAF1N, KAF2B, KAF2N, P135, P135-3, P135-4...(Other models you can see in the webshop)		

producer-specific probes

core probes

Part No.	378550	Ref. No.	32V8360
description	core temperature probe NTC 10kOhm cable silicone probe -40 up to +120°C cable -50 up to +180°C connection 2-wire probe ø4.5x100mm thread cable length 3.8m handle ø 16mm handle length 120mm		
For models:	DM101L, DM31, DM31A, DM31C, DM31M, DM51, DM51A, DM51C, DM51M, DM51ME, DMG101L, DMG102, DMG102-OP141, DMG51C, DMG51M, DMG51ME-OP141, DMG82, DMG82-OP141, DMS101L, DMS101S, DMS102S, DMS51, DMS51A, DMS51C, DMS51M, DMS72S		

Part No.	378402 ¹	Ref. No.	32V7960
description	core temperature probe Pt100 cable silicone probe -40 up to +120°C cable -50 up to +180°C connection 5-wire probe ø5x175mm thread cable length 3.5m handle ø 16mm handle length 125mm		
For models:	IM101L, IM101LR, IM101LW, IM101RAT, IM101S, IM101SC, IM101SR, IM102S, IM102SC, IM102SR, IM102SW, IM51, IM51A, IM51AR, IM51C, IM51CR, IM51H, IM51M, IM51MR, IM51R, IM51WC, IM61, IM72S, IM72SR, IM72SW, IMFEB, IMFEB-OP141, IMFEG, IMFEN, IMFEN-OP141, IMP202R, IMR201R, IMR202R, IMS101L, IMS101S, IMS102S, IMS51, IMS51A, IMS51M, IMS72S, IMSFEB, IMSFEN, IR101L, IR101S, IR51, IR51A, IR51C, IR51M, IR72S		

¹multipoint probe

Part No.	378186	Ref. No.	32V0010 32V0441 32V8600
description	core temperature probe PTC 1kOhm cable silicone probe -40 up to +120°C cable -50 up to +180°C connection 2-wire probe ø4x90mm thread cable length 3.8m handle ø 15mm handle length 120mm L1 175mm L2 190mm		
For models:	AF1L, AF1L7, AF1L7A, AF1L7M, AF2L, AF2S, AF3S, AM14SR, AM1L, AM1L7, AM1L7A, AM1L7M, AM1LM, AM1LR, AM1LT, AM1LT7, AM1LT7A, AM1LT7M, AM1LW, AM2L, AM2LR, AM2LW, AM2S, AM2SR, AM2SW, AM3S, AM3SR, AM3SW, AM4S, AM4SR, AM4SW, AM7SR, DM101L, DM31, DM31A, DM31C, DM31M, DM51, DM51A, DM51C, DM51M, DM51ME, DMG101L, DMG51C, DMG51M, DMG51ME-OP141, DMS101L, DMS101S, DMS102S, DMS51...(Other models you can see in the webshop)		



electronics

PCBs

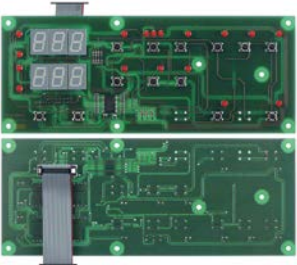

1

Part No.	403729	Ref. No.	32V3060
description	control PCB L 203mm W 80mm		
For models:	AM2L, AM2LR, AM2LW, AM2S, AM2SR, AM2SW, AM3S, AM3SR, AM3SW, AM4S, AM4SR, AM4SW, AM7SR		

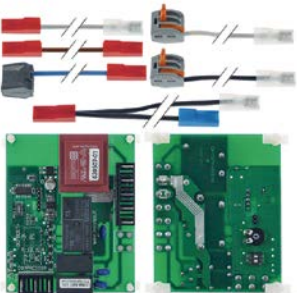

1

Part No.	403687	Ref. No.	62044100
description	electronic timer for ice maker Simag mounting measurements 90x70mm 230		



1

Part No.	401750	Ref. No.	32Z8940
description	keypad PCB		
For models:	AM2L, AM2LR, AM2LW, AM2S, AM2SR, AM2SW, AM3S, AM3SR, AM3SW, AM4S, AM4SR, AM4SW		



1

Part No.	401751	Ref. No.	32Z8240
description	keypad PCB		
For models:	AM1L, AM1LR, AM1LW		



1

Part No.	401749	Ref. No.	32Z9640
description	PCB		
For models:	AM1L, AM1LR, AM1LW, AM2L, AM2LR, AM2LW, AM2S, AM2SR, AM2SW, AM3S, AM3SR, AM3SW, AM4S, AM4SR, AM4SW		



1

Part No.	697908	Ref. No.	32V0740
description	PCB L 102mm W 95mm 50/60Hz 230/400V		



1

Part No.	401747	Ref. No.	32V8030
description	power PCB for blast chiller SERIE IM suitable for SAGI		
For models:	IM101L, IM101LW, IM101RAT, IM101S, IM101SC, IM102S, IM102SC, IM102SW, IM51, IM51A, IM51C, IM51H, IM51M, IM51WC, IM61, IM72S, IM72SW, IMFEB, IMFEB-OP141, IMFEG, IMFEN, IMFEN-OP141, IMS101L, IMS101S, IMS102S, IMS51, IMS51A, IMS51M, IMS72S, IMSFEB, IMSFEN		



keypads

front foils

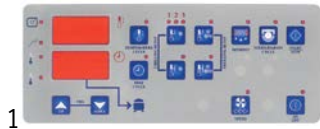

1			
Part No.	378403	Ref. No.	37N0480
description	front foil blast freezer SAGI		
For models:	AM2L, AM2LR, AM2LW, AM2S, AM2SR, AM2SW, AM3S, AM3SR, AM3SW, AM4S, AM4SR, AM4SW, AM7SR		

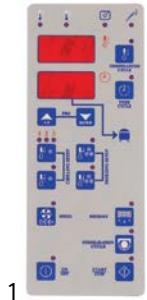

1			
Part No.	401956	Ref. No.	37N0470
description	keypad foil		
For models:	AM14SR, AM1L, AM1L7, AM1L7A, AM1L7M, AM1LR, AM1LW		

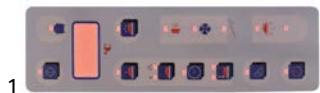

1			
Part No.	401752	Ref. No.	37M7330
description	keypad foil SAGI suitable for for ice maker L 200mm W 60mm buttons 8		
For models:	AM1L, AM1LW		

membrane keypads



1			
Part No.	402027	Ref. No.	37M7340
description	membrane keypad for blast freezer buttons 8 suitable for SAGI L 200mm W 60mm		
For models:	AM2L, AM2LW, AM2S, AM2SR, AM2SW, AM3S, AM3SR, AM3SW, AM4S, AM4SR, AM4SW		

solenoid valves

solenoid valves (water)





TP



1			
Part No.	370015	Ref. No.	33D1371
description	solenoid valve single angled 230VAC inlet 3/4" outlet 11.5mm DN10 TP		
For models:	KAF1B, KAF1B-OP141, KAF1N, KAF1N-OP141, KAF2B, KAF2B-OP141, KAF2N, KAF2N-OP141, KAFRI, KBF16, KBF16A, KBF16M, KBF21, KBF21A, KBF21M		
accessories for	370015		
	Part No.	371220	Ref. No. —
	reducer TP flow rate 3l/min red tolerance ±15%		
	Part No.	371221	Ref. No. —
	reducer TP flow rate 5.5l/min yellow tolerance ±15%		
	Part No.	371222	Ref. No. —
	reducer TP flow rate 6l/min grey tolerance ±15%		
	Part No.	371223	Ref. No. —
	reducer TP flow rate 10l/min white tolerance ±15%		
	Part No.	371224	Ref. No. —
	reducer TP flow rate 12l/min bronze tolerance ±15%		
	Part No.	371225	Ref. No. —
	reducer TP flow rate 16l/min light brown tolerance ±15%		
	Part No.	371226	Ref. No. —
	reducer TP flow rate 20l/min red tolerance ±15%		
	Part No.	371230	Ref. No. —
	reducer TP flow rate 0.25l/min red tolerance ±25%		
	Part No.	371231	Ref. No. —
	reducer TP flow rate 0.35l/min violet tolerance ±25%		
	Part No.	371232	Ref. No. —
	reducer TP flow rate 0.5l/min orange tolerance ±25%		
	Part No.	371233	Ref. No. —
	reducer TP flow rate 0.8l/min white tolerance ±25%		
	Part No.	371234	Ref. No. —
	reducer TP flow rate 1l/min light blue tolerance ±25%		
	Part No.	371235	Ref. No. —
	reducer TP flow rate 1.2l/min brown tolerance ±25%		
	Part No.	371236	Ref. No. —
	reducer TP flow rate 1.5l/min light brown tolerance ±25%		

Table continues overleaf



accessories for		370015		
Part No.	371237	Ref. No.	—	
	reducer TP flow rate 2.5l/min yellow tolerance ±25%			
Part No.	371238	Ref. No.	—	
	reducer TP flow rate 3.4l/min dark green tolerance ±25%			
Part No.	371239	Ref. No.	—	
	reducer TP flow rate 5l/min black tolerance ±25%			
Part No.	371240	Ref. No.	—	
	reducer TP flow rate 8l/min blue tolerance ±20%			

solenoid valves (refrigeration)

PARKER

valves

				
1				
Part No.	370611	Ref. No.	33A0510	
description	solenoid valve 2-way 230V 1.9 tube ø 6mm coil type ZB09 50/60Hz			
For models:	E125SP, E125XSP, E60SP, E60XSP, EKP, EKP218, EKP21C, EKPV, EKV, EKV218, EKV21C, EKVV, F120, F120NN, F120PL, F120PV, F120SP, F40CP, F40CPX, F55, F55PL, F55PV, F55SP, FD140, FD140NN, FD140PV, FD65, FD65PV, GS140BN2, GS140CP, GS140NCP, GS65CP, JA, JA2, JA2A, JA2M, JAA, JAM, JB, JB2, JB2A, JB2M, JB4A, JB4M, JBA, JBM, K160GPZ, K160PS, K160PZ, K160SL...(Other models you can see in the webshop)			

pressure switches

for refrigeration

RANCO

G60 series

				
1				
Part No.	541195	Ref. No.	32Z6350	
description	pressure control RANCO G60H1129401			
For models:	AM4S, AM4SR, AM4SW, N135NN, N65NN, SX65CPN, SX65NN			

compressors

ACC/ZEL

R134A

HMBP monophase

High/Medium evaporation temperature above -20/-15 °C

				
1				
Part No.	605007	Ref. No.	34D6390	
description	compressor coolant R134a type GL60TB 220-240V 50Hz HMBP fully hermetic 9.5kg 1/5HP power input 437W cylinder capacity 5.7cm ³ CSIR H 175.5mm 95W 128W 170W 222W 284W 355W 437W 528W test method ASHRAE ambient temperature max. 43°C			
For models:	E60, E60-2, E60E, E60PL, E60PLE, E60PV, E60PVX, E60SP, E60X, E60X-2, E60XE, E60XSP, F40CP, F40CPX, GS140CP, GS65NB, GS65NCP, GS65NN, K100, K100SL, K100SLV, K100X, K100XA, KM1A, KM1A-11, KM1A-11A, KM1A-11X, KM1A-2, KM1A-2A, KM1A-2X, KM1A-4, KM1A-4A, KM1A-4X, KM1A-A, KM1A-X, KTRA, KTRA2, KTRA2A, KTRA2M, KTRA4, KTRA4A, KTRA4M, KTRAA, KTRAM, RX150CP, RX70BCP, RX70NB, RX70NCP, RX70NN, SX65-2E...(Other models you can see in the webshop)			

				
1				
Part No.	605008	Ref. No.	34D6500	
description	compressor coolant R134a type GL80TB 220-240V 50Hz HMBP fully hermetic 9.5kg 1/5HP power input 554W cylinder capacity 7.6cm ³ CSIR H 175.5mm 165W 215W 290W 390W 500W 615W 727W 840W test method ASHRAE ambient temperature max. 43°C			
For models:	EM1B, EM1B-2, EM1B-2A, EM1B-2X, EM1B-4, EM1B-4A, EM1B-4X, EM1B-A, EM1B-X, EXM1B, EXM1B-2, EXM1B-2A, EXM1B-2X, EXM1B-4, EXM1B-4A, EXM1B-4X, EXM1B-A, EXM1B-X, F55, F55PL, F55PV, F55SP, JB, JB2, JB2A, JB2M, JB4A, JB4M, JBA, JBM, KPE1633, KPE1633V, KPZ20, KPZ2033A, KPZ2033B, KPZ2037A, KPZ2037B, N135BN, N65, N65-2, N65GT, N65PS, N65PV			



Part No.	605009	Ref. No.	34D6510
description	compressor coolant R134a type GL90TB 220-240V 50Hz HMBP fully hermetic 10.8kg 1/4HP power input 293W cylinder capacity 8.8cm ³ CSIR H 175.5mmW 143W 194W 259W 339W 432W 539W 661W 796W test method ASHRAE		
For models:	K160PS, K200PS, KM1B, KM1B-11, KM1B-11A, KM1B-11X, KM1B-2, KM1B-22, KM1B-22A, KM1B-22X, KM1B-2A, KM1B-2X, KM1B-4, KM1B-4A, KM1B-4X, KM1B-6, KM1B-6A, KM1B-6X, KM1B-A, KM1B-X, KM1C, KM1C-11, KM1C-11A, KM1C-11X, KM1C-2, KM1C-2A, KM1C-2X, KM1C-4, KM1C-4A, KM1C-4X, KM1C-6, KM1C-6A, KM1C-6X, KM1C-8, KM1C-8A, KM1C-8X, KM1C-A, KM1C-X, KTRB, KTRB11, KTRB11A, KTRB11M, KTRB2, KTRB2A, KTRB2M, KTRB4, KTRB4A, KTRB4M, KTRB6, KTRB6A... (Other models you can see in the webshop)		



Part No.	605010	Ref. No.	34D6520 34D6760
description	compressor coolant R134a type GP12TB 220-240V 50Hz HMBP fully hermetic 11.2kg 3/8HP power input 661W cylinder capacity 12cm ³ CSIR H 203.6mmW 143W 194W 259W 339W 432W 539W 661W 796W test method ASHRAE ambient temperature max. 43°C		
For models:	E125, E125-4, E125E, E125PL, E125PLE, E125PV, E125PVX, E125SP, E125X, E125X-4, E125XE, E125XSP, EM1C, EM1C-2, EM1C-2A, EM1C-2X, EM1C-4, EM1C-4A, EM1C-4X, EM1C-6, EM1C-6A, EM1C-6X, EM1C-A, EM1C-X, EXM1C, EXM1C-2, EXM1C-2A, EXM1C-2X, EXM1C-4, EXM1C-4A, EXM1C-4X, EXM1C-6, EXM1C-6A, EXM1C-6X, EXM1C-A, EXM1C-X, F120, F120NN, F120PL, F120PV, F120SP, FD140NN, FD65, FD65PV, GR65TN, GS140BN2, GS140CP, GS140NCP, GS65CP, KPE2033... (Other models you can see in the webshop)		

EMBRACO / ASPERA

R134A
HBP monophase

High evaporation temperature above -15°C



Part No.	605209	Ref. No.	34D5490
description	compressor coolant R134a type NEK6187Z-A 220-240V 50Hz HBP 11kg 1/3HP cylinder capacity 10cm ³ CSIR H 200mmWWW 365W 482W 624W 791W 983W 1201W test method EN 12900 ambient temperature max. 55°C		
For models:	TE1B, TE1B-11, TE1B-11A, TE1B-11X, TE1B-2, TE1B-22, TE1B-22A, TE1B-22X, TE1B-2A, TE1B-2X, TE1B-3, TE1B-3A, TE1B-3X, TE1B-4, TE1B-4A, TE1B-4X, TE1B-A, TE1B-X, TE1C, TE1C-11, TE1C-11A, TE1C-11X, TE1C-2, TE1C-22, TE1C-22A, TE1C-22X, TE1C-2A, TE1C-2X, TE1C-3, TE1C-33, TE1C-33A, TE1C-33X, TE1C-3A, TE1C-3X, TE1C-4, TE1C-4A, TE1C-4X, TE1C-6, TE1C-6A, TE1C-6X, TE1C-A, TE1C-X, TM1B, TM1B-11, TM1B-11A, TM1B-11X, TM1B-2, TM1B-22, TM1B-22A, TM1B-22X... (Other models you can see in the webshop)		

evaporation and condensing trays

condensing trays heated

universal

heating cartridges



Part No.	418892	Ref. No.	32G3310
description	heating cartridge 300W 230V ø 12mm L 240mm thread 3/8" cable length 2000mm immersion heater		
For models:	AS120, AS120BN, AS120NN, AS140, AS140BN, AS140NN, AS150, AS55, AS65, AS70, AX120, AX120BN, AX120NN, AX130, AX130NN, AX140, AX140BN, AX140NN, AX150, AX150NN, AX55, AX60, AX65, AX70, CD150R, CD70BR, CD70R, DMG102, DMG102-0P141, DMG82, DMG82-0P141, FD150, FD150LT, FD70, FD70LT, GS120, GS120BN, GS120NN, GS130, GS130NN, GS140, GS140BB, GS140BN, GS140BN2, GS140BR, GS140CP, GS140NCP, GS140NN, GS140PV, GS140R... (Other models you can see in the webshop)		

accessories for 418892

	Part No.	511472	Ref. No.	—
	nut thread 3/8" H 4mm brass WS 21 Qty 1 pcs			

	Part No.	518393	Ref. No.	—
	flat gasket FIBER ED ø 24mm ID ø 17mm thickness 2mm Qty 1 pcs			



fans

axial fans

import



Part No.	601604 ¹	Ref. No.	32M7130
description	axial fan L 119mm W 119mm H 38mm 230VAC 50/60Hz 17/15W bearing slide bearing manuf. no. AA1282HS-AT connection cable 300mm fan wheel ø 110mm temp.-resist. 70°C input current 0.1A airflow 130m³/h 2600rpm		
For models:	S900, S900P		

¹with slide bearings





refrigeration fans

refrigeration motors universal





ELCO

N series - multi fit



Part No.	601427	Ref. No.	32M4041 32M6870
description	fan motor ELCO 10W 230V 50/60Hz bearing slide bearing L1 49mm L2 59mm L3 86.5mm W 83mm connection cable 500mm 1300/1550rpm 5 mounting options VNT10-20/028		
For models:	AM03LT7, AM03LT7A, AM03LT7M, AM1LW, AM2LW, AM2SW, AM3SW, AM4SW, AS120, AS120B, AS120BN, AS120NN, AS140, AS140B, AS140BN, AS140NN, AS150, AS150B, AS55, AS55B, AS65, AS65B, AS70, AS70B, AT1L, AT1L7, AT1L7A, AT1L7M, AX120, AX120B, AX120NN, AX130, AX130B, AX130NN, AX140, AX140B, AX140NN, AX150, AX150B, AX150NN, AX55, AX55B, AX60, AX60B, AX65, AX65B, AX70, AX70B, DR51, DR51A... (Other models you can see in the webshop)		
spare parts for	601427		
	Part No.	560140	Ref. No. —
	hexagonal nut thread M4 H 4.8mm SS WS 7 Qty 20 pcs DIN/ISO DIN 985 self-locking		
	Part No.	560332	Ref. No. —
	plain washer ID ø 4.3mm ED ø 9mm thickness 0.8mm SS Qty 1 pcs		
	Part No.	560340	Ref. No. —
	hexagonal nut thread M4 H 3.2mm WS 7 SS DIN/ISO DIN 934 / ISO 4032/8673 Qty 1 pcs		
	Part No.	601413	Ref. No. —
	fixing plate suitable for fanwheel ED ø 32mm shaft ø 7 mounting distance 26mm		



Part No.	601430	Ref. No.	32M4351
description	fan motor ELCO 5W 230V 50/60Hz bearing slide bearing L1 48mm L2 52mm L3 79.5mm W 83mm connection cable 500mm 1300/1550rpm 5 mounting options VNT5-13/027		
For models:	E125, E125-4, E125B, E125B-4, E125BE, E125BPL, E125BPPL, E125BX, E125BX-4, E125BXE, E125E, E125PL, E125PLE, E125PV, E125PVX, E125SP, E125X, E125X-4, E125XE, E125XSP, E60, E60-2, E60B, E60B-2, E60BE, E60BPL, E60BPPL, E60BX, E60BX-2, E60BXE, E60E, E60PL, E60PLE, E60PV, E60PVX, E60SP, E60X, E60X-2, E60XE, E60XSP, F40CP, F40CP-OP141, F40CPX, F40CPX-OP141, KAL1633, KAL1633V, KAL1637, KAL1637V, KAL2033, KAL2033V...(Other models you can see in the webshop)		
spare parts for	601430		
	Part No.	560140	Ref. No. —
	hexagonal nut thread M4 H 4.8mm SS WS 7 Qty 20 pcs DIN/ISO DIN 985 self-locking		
	Part No.	560332	Ref. No. —
	plain washer ID ø 4.3mm ED ø 9mm thickness 0.8mm SS Qty 1 pcs		
	Part No.	560340	Ref. No. —
	hexagonal nut thread M4 H 3.2mm WS 7 SS DIN/ISO DIN 934 / ISO 4032/8673 Qty 1 pcs		
	Part No.	601413	Ref. No. —
	fixing plate suitable for fanwheel ED ø 32mm shaft ø 7 mounting distance 26mm		

N series - standard



Part No.	601708 ¹	Ref. No.	32M7020
description	fan motor ELCO 10W 230V 50/60Hz bearing slide bearing L3 82.5mm W 66mm connection Plug In cable lengthmm 1300/1550rpm VN10-20/1124		
For models:	AM03LT7, AM03LT7A, AS120, AS120B, AS120BN, AS120NN, AS140, AS140B, AS140BN, AS140NN, AS55, AS55B, AS65, AS65B, AT1L7, AT-1L7A, AT1L7M, AX120, AX120B, AX120BN, AX120NN, AX140, AX140B, AX140BN, AX140NN, AX55, AX55B, AX65, AX65B, CD130, CD130B, CD130BN, CD130NN, CD150, CD150B, CD150BB, CD150BN, CD150BR, CD150CP, CD150NN, CD150PV, CD150R, CD60, CD60B, CD70, CD702, CD70B, CD70B2, CD70BPV, CD70BR...(Other models you can see in the webshop)		
spare parts for	601708		
	Part No.	601413	Ref. No. —
	fixing plate suitable for fanwheel ED ø 32mm shaft ø 7 mounting distance 26mm		

¹with coded connector
Table continues overleaf



accessories for	601708		
	Part No.	601892	Ref. No.
	connector cable	ELCO cable length 1500mm	0.75mm ² protection IP42 for Plug-In

RE series			
			
1			
Part No.	602051	Ref. No.	32M7240
description	fan motor 18/62W 230V 50/60Hz 2600rpm		
For models:	IM51H, KAGL6B, KDMS51A, KFSD2B-OP141, KFSD2B2-OP141, KFSDR2B-OP141, KFSDR2B2-OP141, KFSE2B-OP141, KFSE2B2-OP141, KFSER2B-OP141, KFSER2B2-OP141		

BT series - capacitor motors			
			
1			
Part No.	601820 ¹	Ref. No.	32M4701
description	fan motor 35W 230V 50/60Hz L2 89mm L3 110mm W 82mm cable length 2150mm 1300/1550rpm ELCO incl. capacitor capacitor 2.5µF		
For models:	AF2L, AF2S, AM1L, AM1L7, AM1L7A, AM1L7M, AM1LM, AM1LT, AM1LT7, AM1LT7A, AM1LT7M, AM2L, AM2S, DM101L, DM51, DM51A, DM51C, DM51M, DMG101L, DMG102, DMG102-OP141, DMG51C, DMG51M, DMG82, DMS101L, DMS101S, DMS51, DMS51A, DMS51C, DMS51M, GR135BT, GR1A, GR2A, IM101L, IM101RAT, IM101S, IM101SC, IM51, IM51A, IM51C, IM51M, IMFEB, IMFEB-OP141, IMFEG, IMFEN, IMFEN-OP141, IMS101L, IMS101S, IMS51, IMS51A...(Other models you can see in the webshop)		

¹incl. capacitor

IMPORT			
multi fit fan motors WEIGUANG			
			
			
1			
Part No.	601022	Ref. No.	32M0220 32M1060 32M4371
description	fan motor 10W 230V 50-60Hz L1 44mm L2 54mm L3 85mm W 84mm cable length 500mm 1300rpm YZF10-20-18/26 5 mounting options bearing slide bearing		

			
			
1			
Part No.	601020	Ref. No.	32M4350
description	fan motor 5W 230V 50-60Hz L1 44mm L2 48mm L3 79mm W 84mm cable length 500mm 1300rpm YZF5-13-18/26 5 mounting options bearing slide bearing		

accessories			
fan wheels			
aluminium			
			
1			
Part No.	601070	Ref. No.	32M3280
description	fan wheel sucking ø 200mm fan wheel mounting 25.4mm blade angle 28° W 38mm aluminium		
For models:	AS70, AX130NN, AX150NN, AX60, AX70, CD130, CD130B, CD130BN, CD130NN, CD150, CD150B, CD150BB, CD150BN, CD150BR, CD150CP, CD150NN, CD150PV, CD150R, CD60, CD60B, CD70, CD702, CD70B, CD70B2, CD70BPV, CD70BR, CD70CP, CD70PV, CD70PVSX, CD70R, CDPT, CDRI, E125, E125-4, E125B, E125B-4, E125BE, E125BPL, E125BPLE, E125BX, E125BX-4, E125BXE, E125E, E125PL, E125PLE, E125PV, E125PVX, E125SP, E125X, E125X-4...(Other models you can see in the webshop)		

			
1			
Part No.	601282	Ref. No.	32M1550
description	fan wheel sucking ø 200mm fan wheel mounting 25.4mm blade angle 34° W 44mm aluminium		
For models:	AS120, AS120B, AS120BN, AS120NN, AS140, AS140B, AS140BN, AS140NN, AS150, AS150B, AS55, AS55B, AS65, AS65B, AS70, AS70B, AT1L, AT1L7, AT1L7A, AT1L7M, AX120, AX120B, AX120BN, AX120NN, AX130, AX130B, AX130NN, AX140, AX140B, AX140BN, AX140NN, AX150, AX150B, AX150NN, AX55, AX55B, AX60, AX60B, AX65, AX65B, AX70, AX70B, DM51ME, DMG51ME, DMG51ME-OP141, DR51, DR51A, DR51M, E1200, E12004...(Other models you can see in the webshop)		

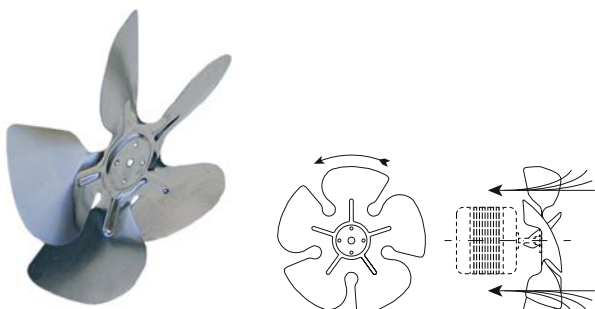

1

Part No.	601072	Ref. No.	32M1080
description	fan wheel sucking ø 250mm fan wheel mounting 25.4mm blade angle 25° W 50mm aluminium		
For models:	AS120, AS120B, AS120BN, AS120NN, AS140, AS140B, AS140BN, AS140NN, AS150, AS150B, AS55, AS65, AX120, AX120B, AX120BN, AX120NN, AX130, AX130B, AX140, AX140B, AX140BN, AX140NN, AX150, AX150B, AX55, AX65, CDG150, E1200B, E1200B4, E1200BE, E125BE, E125BPLE, E125BXE, E60B, E60B-2, E60BPL, E60BX, E60BX-2, F120, F120B, F120NN, F120PL, F120PV, F120SP, FD140, FD140PV, FD65B, FD70, FD70LT, GR65BT...(Other models you can see in the webshop)		

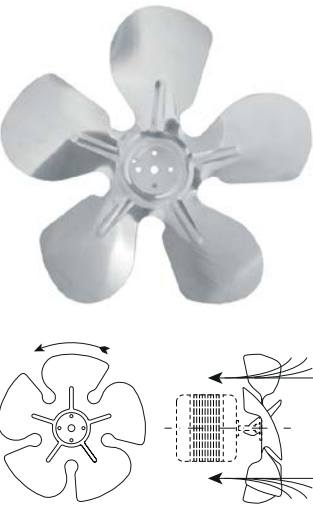

1

Part No.	601387	Ref. No.	32M2260
description	fan wheel sucking ø 254mm fan wheel mounting 25.4mm blade angle 34° W 50mm aluminium		
For models:	AM1L, AM1LT, AS120B, AS140B, AX120B, AX140B, CD130B, CD150B, CDG150B, E125B, E125B-4, E125BPL, E125BX, E125BX-4, EKP, EKP218, EKP21C, EKPV, EKV, EKV218, EKV21C, EKVV, FD140B, FD150B, GS120B, GS130B, GS140B, GS140BPV, GS150B, HD130B, HD150B, IMFEB, IMFEB-OP141, IMFEG, IMFEN, IMFEN-OP141, IMSFEB, IMSFEN, KAF2B, KAF2B-OP141, KAFRI, KD12Q1M, KD12Q2, KD12Q2M, KFG2B, KFSD2B, KFSD2B2, KFSE2B, KFSE2B2, ME150B...(Other models you can see in the webshop)		

cooling motors (various)

accessories for cooling fan

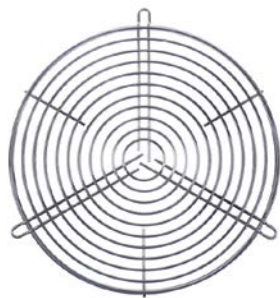

1

Part No.	601514	Ref. No.	36C4790
description	guard H 30mm mounting distance 225mm W 240mm evaporator fan		
For models:	AS120, AS120B, AS120BN, AS120NN, AS140, AS140B, AS140BN, AS140NN, AS150, AS150B, AS55, AS55B, AS65, AS65B, AS70, AS70B, AX120, AX120B, AX120BN, AX120NN, AX130, AX130B, AX130NN, AX140, AX140B, AX140BN, AX140NN, AX150, AX150B, AX150NN, AX55, AX55B, AX60, AX60B, AX65, AX65B, AX70, AX70B, E1200, E12004, E1200B, E1200B4, E1200BE, E1200E, E1200PV, E600, E6002, E600B, E600B2, E600BE...(Other models you can see in the webshop)		



cold air circulating fans (complete)

ebm-papst

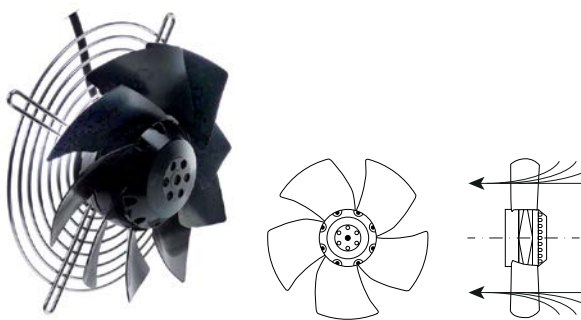
A2E series





1

Part No.	601663 ¹	Ref. No.	32M6610	
description	fan A2E200-AI38-10 fan wheel ø 200mm blades 9 230V 50/60Hz 64W 2600rpm cable length 450mm ebm-papst sucking suitable capacitor 1.5µF with protective grid			
For models:	AF2L, AF2S, AF3S, AM03LT7, AM03LT7A, AM03LT7M, AT1L, AT1L7, AT-1L7A, AT1L7M, DM31, DM31A, DM31C, DM31M, DR51, DR51A, DR51M			
spare parts for	601663			
	Part No.	365171	Ref. No.	—
	capacitor capacity 1.5µF 400V tolerance 5% 50/60Hz ambient temperature max. -40 up to +85°C ø 25mm L 50mm M8 plastic connection cable 250mm MLR25PRL			
	Part No.	601958	Ref. No.	—
	guard ø 210mm for fan hole distance 258mm			

¹incl. capacitor and guard

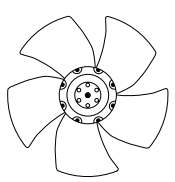
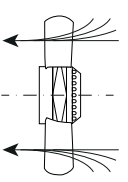

			
			
			
1			
Part No.	601964	Ref. No.	32M4720 32M6850
description	fan A2E250AM06-12 fan wheel ø 250mm blades 9 230V 50/60Hz 115/150W ø 250mm 2450rpm cable length 1400mm sucking suitable capacitor 3µF		
For models:	AF1L, AF1L7, AF1L7A, AF1L7M, AM1LM, AM1LT, AM1LT7, AM1LT7A, AM1LT7M, DM101L, DM51, DM51A, DM51C, DM51M, DM51ME, DMG101L, DMG102, DMG102-0P141, DMG51C, DMG51M, DMG51ME, DMG51ME-0P141, DMG82, DMG82-0P141, DMS101L, DMS101S, DMS51, DMS51A, DMS51C, DMS51M, DMS72S, IM101L, IM101LR, IM-101LW, IM101RAT, IM101S, IM101SC, IM101SR, IM51, IM51A, IM51AR, IM51C, IM51CR, IM51H, IM51M, IM51MR, IM51R, IM51WC, IM72S, IM72SR...(Other models you can see in the webshop)		
spare parts for	601964		
	Part No.	365137	Ref. No. —
	capacitor capacity 3µF 450V tolerance 5% 50/60Hz ambient temperature max. -25 to +85°C ø 25mm L 56mm M8 plastic connection cable 250mm 416.17.77GF protection		

miscellaneous

			
1			
Part No.	601810	Ref. No.	32M6220
description	fan 230V 50Hz ø 278mm suitable capacitor 4µF ECOFIT type 2VRE35 H 90mm fan wheel ø 250mm cable length 2000mm		
For models:	AM1L, AM1L7, AM1L7A, AM1L7M, AM1LR, AM1LW, AM2L, AM2LR, AM2LW, AM2S, AM2SR, AM2SW, AM3S, AM3SR, AM3SW		

cross flow fans

COPREL

with standard coil

			
1			
Part No.	601032	Ref. No.	32M0521 32M2090
description	cross flow fan COPREL TFL(FN) roller ø 60mm roller length 180mm laminated core thickness 15mm motor position left 230V/50Hz 19W bearing rubber connection male faston 6.3mm coil type airflow 107m³/h -10 up to +60°C refrigeration		

			
1			
Part No.	601452	Ref. No.	32M0521 32M5920
description	cross flow fan TFL 180 roller ø 60mm roller length 180mm laminated core thickness 20mm motor position left 230V/50Hz 19W universal bearing silicone connection male faston 6.3mm airflow 100m³/h -30 up to +100°C 230V 50Hz		
For models:	EKP, EKP218, EKP21C, EKPV, EKV, EKV218, EKV21C, EKV, EM1B, EM1B-2, EM1B-2A, EM1B-2X, EM1B-4, EM1B-4A, EM1B-4X, EM1B-A, EM1B-X, EXM1B, EXM1B-2, EXM1B-2A, EXM1B-2X, EXM1B-4, EXM1B-4A, EXM1B-4X, EXM1B-A, EXM1B-X, F120, F120NN, F120PL, F120PV, F120SP, F40, F40-0P141, F40PLA, F40PLPV, F40PV, F40PV-0P141, F40X, F40X-0P141, F55, F55PL, F55PV, F55SP, K100, K100SL, K100SLV, K100X, K100XA, K200PS, KBPZ16...(Other models you can see in the webshop)		

double fans

			
1			
Part No.	601026	Ref. No.	32M1220 32M2210
description	cross flow fan COPREL TFD(FD) roller ø 60mm roller length 2x180mm laminated core thickness 35mm motor position centre 230V/50-60Hz 42W refrigeration bearing rubber connection male faston 6.3mm coil type airflow 255m³/h -10 up to +60°C		



condensators & interference suppression filters

starting capacitors

starting capacitors



1

Part No.	365095	Ref. No.	32V1490
description	starting capacitor 43µF 330V 50/60Hz duty cycle 3 60A1D-330043NXET ø 36mm L 80mm M8 plastic connection cable 350mm 04P.5523CM		
For models:	E125, E125-4, E125E, E125PL, E125PLE, E125PV, E125PVX, E125SP, E125X, E125X-4, E125XE, E125XSP, E60, E60-2, E60E, E60PL, E60PLE, E60PV, E60PVX, E60SP, E60X, E60X-2, E60XE, E60XSP, EM1A, EM1A-2, EM1A-2A, EM1A-2X, EM1A-A, EM1A-X, EM1B, EM1B-2, EM1B-2A, EM1B-2X, EM1B-4, EM1B-4A, EM1B-4X, EM1B-A, EM1B-X, EM1C, EM1C-2, EM1C-2A, EM1C-2X, EM1C-4, EM1C-4A, EM1C-4X, EM1C-6, EM1C-6A, EM1C-6X, EM1C-A...(Other models you can see in the webshop)		

operating capacitors

plastic



1

Part No.	365225	Ref. No.	32V5980
description	operating capacitor capacity 35µF 420V tolerance 5% 50/60Hz ambient temperature max. -25 to +85°C ø 45mm L 95mm M8 plastic connection male faston 6.3mm protection		

equipmentspecific units

for fridges

miscellaneous

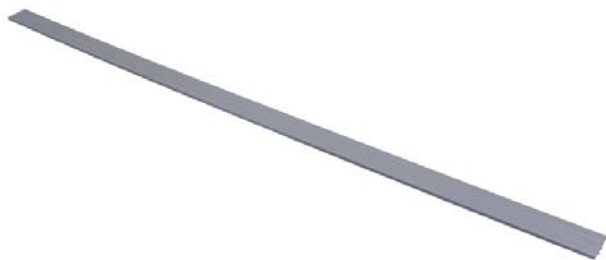

1

Part No.	695580	Ref. No.	36D1250
description	frame L 1528mm W 55mm		
For models:	F120, F120B, F120PL, F120PV, F120SP, N135, N135-3, N135-4, N135B, N135BPS, N135PS, N135PV, P135, P135-3, P135-4, P135B, SX120, SX120B, SX120PV, SX135, SX135-3, SX135-3E, SX135-4, SX135-4E, SX135AX, SX135B, SX135B-3, SX135B-4, SX135BAX, SX135BE, SX-135BR, SX135CP, SX135E, SX135ES, SX135PV, SX135R		



1

Part No.	695581	Ref. No.	36D1290
description	frame L 1639mm W 55mm		
For models:	E125, E125-4, E125B, E125B-4, E125BE, E125BPL, E125BPPE, E125BX, E125BX-4, E125BXE, E125E, E125PL, E125PLE, E125PV, E125PVX, E125SP, E125X, E125X-4, E125XE, E125XSP, E60, E60-2, E60B, E60B-2, E60BE, E60BPL, E60BPPE, E60BX, E60BX-2, E60BXE, E60E, E60PL, E60PV, E60PVX, E60SP, E60X, E60X-2, E60XE, E60XSP, F120, F120B, F120NN, F120PL, F120PV, F120SP, F55, F55B, F55PL, F55PV, F55SP... (Other models you can see in the webshop)		

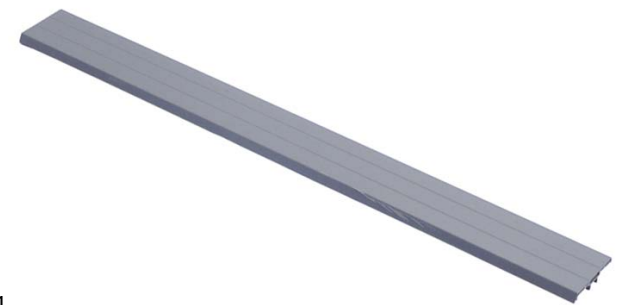

1

Part No.	695579	Ref. No.	36D1260
description	frame L 621mm W 55mm		
For models:	E60PLE, N135-3, N135-4, N65-2, N65NB, N65NN, P135-3, P135-4, P135NN-3, P65-2, SX135-3, SX135-3E, SX135-4, SX135-4E, SX135B-3, SX135B-4, SX135BN2, SX135CP, SX65-2, SX65-2E, SX65CPB, SX65CPN, SX65N-3C, SX65NB, SX65NN		



1

Part No.	694636	Ref. No.	33Q6300
description	hose ID ø 21mm ED ø 27mm L 66mm ø 40mm thickness 3.5mm		
For models:	KAF2B, KAF2B-OP141, KAF2N, KAF2N-OP141		



1

Part No.	690689	Ref. No.	35X3460
description	spacer ring		
For models:	F40EV, F40EVP, F40PLPV, F40PV		



1

Part No.	690691	Ref. No.	36C2440
description	spacer ring		
For models:	F40EV, F40EVP, F40PLPV, F40PV		



1

Part No.	698476	Ref. No.	36E3990
description	thermostatic steam trap W 55mm H 45mm for fridge D1 ø 22mm D2 ø 16mm		
For models:	AS120NN, AS140NN, AX120NN, AX130NN, AX140NN, AX150NN, GS120BN, GS120NN, GS130NN, GS140BB, GS140BN, GS140BN2, GS140NN, GS150NN, HD130NN, HD150NN, KBP41P, KBP41X, KBP53G, KBP53V, KBP53X, KBP64G, KBP64V, KBP64X, KBP83G, KBP83V, KBP83X, KBP94G, KBP94V, KBP94X, KBPZ16, KBPZ163A, KBPZ163B, KBPZ163S, KBPZ167A, KBPZ167B, KBPZ167S, KBPZ20, KBPZ203A, KBPZ203B, KBPZ203S, KBPZ207A, KBPZ207B, KBPZ207S, KBPZ25, KBPZ253A, KBPZ253B, KBPZ257A, KBPZ257B, KBS11...(Other models you can see in the webshop)		

for refrigerated counters

lid hinges



1

Part No.	691099	Ref. No.	35G4630
description	hinge for lid mounting pos. left		
For models:	K100SLV		

spare parts and accessories



1

Part No.	692916	Ref. No.	36C3100
description	bracket W 37mm H 17mm		



1

Part No.	691189	Ref. No.	36G8660
description	bush L 9mm ID ø 7mm ext. ø 10		
For models:	AF1L7, AF1L7A, AF1L7M, AM03LT7, AM03LT7A, AM03LT7M, AM1L7, AM1L7A, AM1L7M, AM1LT7, AM1LT7A, AM1LT7M, AT1L7, AT1L7A, AT1L7M, DM31, DM31A, DM31C, DM31M, DM51, DM51A, DM51C, DM51M, DM51ME, DMG51C, DMG51M, DMG51ME, DMS51, DMS51A, DMS51C, DMS51M, DR51, DR51A, DR51M, EM1A, EM1A-2, EM1A-2A, EM1A-2X, EM1A-A, EM1A-X, EM1B, EM1B-2, EM1B-2A, EM1B-2X, EM1B-4, EM1B-4A, EM1B-4X, EM1B-A, EM1B-X, EM1C...(Other models you can see in the webshop)		

for freezer cabinets

glass panels



1

Part No.	700682	Ref. No.	37W0270
description	glass panel L 190mm W 310mm mounting pos. lateral		
For models:	KAL1433V, KAL1437V, KAL1633V, KAL1637V, KAL2033V, KAL2037V, KAL2533V, KAL2537V, KAR143V, KAR147V, KAR163V, KAR167V, KAR203V, KAR207V, KAR253V, KAR257V, KBP53V, KBP64V, KBP83V, KBP94V, KBPZ163A, KBPZ163B, KBPZ163S, KBPZ167A, KBPZ167B, KBPZ167S, KBPZ203A, KBPZ203B, KBPZ203S, KBPZ207A, KBPZ207B, KBPZ207S, KBPZ253A, KBPZ253B, KBPZ257A, KBPZ257B, KPE1633V, KPE2033V, KPM1633V, KPM2033V, KPZ1633A, KPZ1633B, KPZ1637A, KPZ1637B, KPZ2033A, KPZ2033B, KPZ2037A, KPZ2037B, KPZ2533A, KPZ2533B...(Other models you can see in the webshop)		



for ice-cube maker

hoses

miscellaneous



1

Part No.	694636	Ref. No.	33Q6300
description	hose ID ø 21mm ED ø 27mm L 66mm ø 40mm thickness 3.5mm		
For models:	KAF2B, KAF2B-OP141, KAF2N, KAF2N-OP141		

handles and hand wheels

handle bars

consoles



1

Part No.	691135	Ref. No.	36M2910
description	console for door handle		

bracket handles



1

Part No.	690451	Ref. No.	36M4040
description	pull handle L 426mm H 40mm mounting distance 376mm black		
For models:	F40EVP, F40PLPV, F40PV		

miscellaneous



1

Part No.	691193	Ref. No.	36M4640
description	handle thread M5		
For models:	QE14PRV, QE14VRV, QI14PRV, QI14VRV, QL14RPRV, QL14RVRV		

locks

locking devices

producer-specific

SAGI



1

Part No.	690662	Ref. No.	36M0140
description	key cylinder with slide latch ø 23mm thread M19x1 cam width 11mm mounting measurements 16.5x19mm hub 20-28mm thread L 15mm		
For models:	E125, E125-4, E125B, E125B-4, E125BE, E125BPL, E125BPLE, E125BX, E125BX-4, E125BXE, E125E, E125PL, E125PLE, E125PV, E125PVX, E125SP, E125X, E125X-4, E125XE, E125XSP, E60, E60-2, E60B, E60B-2, E60BE, E60BPL, E60BPLE, E60BX, E60BX-2, E60BXE, E60E, E60PL, E60PLE, E60PV, E60PVX, E60SP, E60X, E60X-2, E60XE, E60XSP, F40B, F40CP, F40CPX, F40EV, F40EVP, N135, N135-3, N135-4, N135B, N135BN...(Other models you can see in the webshop)		

edgmount latches

handle latches

CAFF/FERMOD

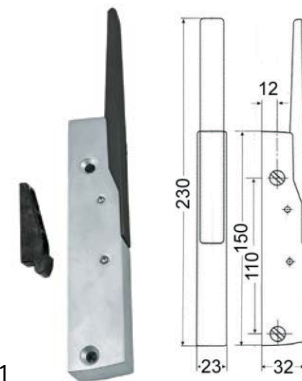

1

Part No.	690454	Ref. No.	36M0470	
description	handle latch L 150mm mounting distance 110mm matt chrome-plated/Rilsan non lockable heated units 560 black complete with door catch			
spare parts for	690454			
	Part No.	690429	Ref. No.	—
	door catch CT 25.5mm			
accessories for	690454			
	Part No.	690428	Ref. No.	36M0480
	door catch H 51mm W 13.9mm mounting distance 30mm plastic CT 16.5mm			
	Part No.	690445	Ref. No.	—
	base plate H 2mm			
	Part No.	690446	Ref. No.	—
	base plate H 5mm L 56mm W 18mm			



door catches



Part No.	690428	Ref. No.	36M0480
description	door catch H 51mm W 13.9mm mounting distance 30mm plastic CT 16.5mm		

hinges

spring assisted hinges

universal

CAFF/FERMOD

group 2

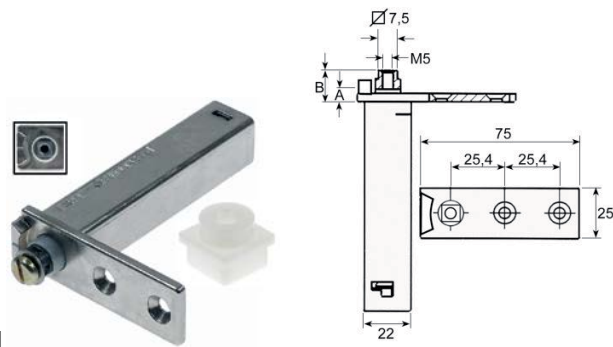

Part No.	690574	Ref. No.	36M2460
description	spring assisted hinge series 176 mounting pos. left/right L 75mm W 25.6mm A 11mm B 15mm mounting measurements 22x22mm intake 7.5x7.5		

INTERKLIMAT

hinges

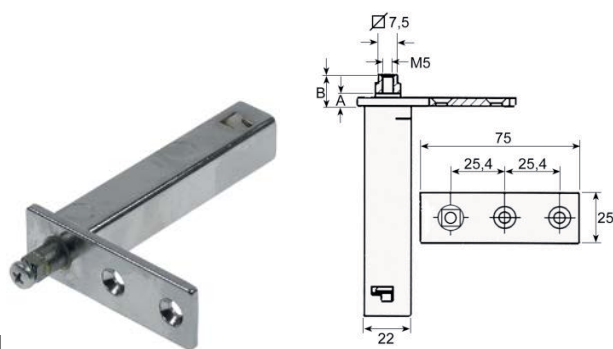

Part No.	690622	Ref. No.	36G6520
description	spring assisted hinge series 28L mounting pos. left/right L 75mm W 25mm H 103mm A 13mm B 18mm mounting measurements 22x22mm intake 7.5x7.5 refrigeration units		
For models:	AF1L, AF2L, AF2S, AF3S, AM1L, AM1LM, AM1LR, AM1LT, AM1LW, AM2L, AM2LR, AM2LW, AM2S, AM2SR, AM2SW, AM3S, AM3SR, AM3SW, AM4S, AM4SR, AM4SW, AS120, AS120B, AS120BN, AS120NN, AS140, AS140B, AS140BN, AS140NN, AS55, AS55B, AS65, AS65B, AT1L, AX120, AX120B, AX120BN, AX120NN, AX140, AX140B, AX140BN, AX140NN, AX55, AX55B, AX65, AX65B, CD130, CD130B, CD130BN, CD130NN...(Other models you can see in the webshop)		

accessories



Part No.	690747	Ref. No.	3178300
description	bush for hinge ID \varnothing 7.5mm L 25.5mm W 25.5mm white mounting measurements 22x22mm H 4.5mm		
For models:	AF1L, AF2L, AF2S, AF3S, AM1L, AM1LM, AM1LR, AM1LT, AM1LW, AM2L, AM2LR, AM2LW, AM2S, AM2SR, AM2SW, AM3S, AM3SR, AM3SW, AM4S, AM4SR, AM4SW, AS120, AS120B, AS120BN, AS-120NN, AS140, AS140B, AS140BN, AS140NN, AS150, AS150B, AS55, AS55B, AS65, AS65B, AS70, AS70B, AT1L, AX120, AX120B, AX120BN, AX120NN, AX130, AX130B, AX130NN, AX140, AX140B, AX140BN, AX140NN, AX150...(Other models you can see in the webshop)		

producer-specific

ELECTROLUX/ZANUSSI



Part No.	690747	Ref. No.	3178300
description	bush for hinge ID \varnothing 7.5mm L 25.5mm W 25.5mm white mounting measurements 22x22mm H 4.5mm		
For models:	AF1L, AF2L, AF2S, AF3S, AM1L, AM1LM, AM1LR, AM1LT, AM1LW, AM2L, AM2LR, AM2LW, AM2S, AM2SR, AM2SW, AM3S, AM3SR, AM3SW, AM4S, AM4SR, AM4SW, AS120, AS120B, AS120BN, AS-120NN, AS140, AS140B, AS140BN, AS140NN, AS150, AS150B, AS55, AS55B, AS65, AS65B, AS70, AS70B, AT1L, AX120, AX120B, AX120BN, AX120NN, AX130, AX130B, AX130NN, AX140, AX140B, AX140BN, AX140NN, AX150...(Other models you can see in the webshop)		

SAGI



Part No.	690747	Ref. No.	3178300
description	bush for hinge ID \varnothing 7.5mm L 25.5mm W 25.5mm white mounting measurements 22x22mm H 4.5mm		
For models:	AF1L, AF2L, AF2S, AF3S, AM1L, AM1LM, AM1LR, AM1LT, AM1LW, AM2L, AM2LR, AM2LW, AM2S, AM2SR, AM2SW, AM3S, AM3SR, AM3SW, AM4S, AM4SR, AM4SW, AS120, AS120B, AS120BN, AS-120NN, AS140, AS140B, AS140BN, AS140NN, AS150, AS150B, AS55, AS55B, AS65, AS65B, AS70, AS70B, AT1L, AX120, AX120B, AX120BN, AX120NN, AX130, AX130B, AX130NN, AX140, AX140B, AX140BN, AX140NN, AX150...(Other models you can see in the webshop)		



Part No.	690675	Ref. No.	6008500
description	spring assisted hinge left		
For models:	N135PV, SX120PV, SX135PV		

1

Part No.	690573	Ref. No.	30M0350 36M0350
description	spring assisted hinge left refrigerator suitable for SAGI		



1

Part No.	690674	Ref. No.	6008490
description	spring assisted hinge right L 128mm spring thickness 2.5mm		
For models:	F55PV, N135PV, N65GT, N65PV, SX120PV, SX135PV, SX55PV, SX65PV		



1

Part No.	690572	Ref. No.	36M0340
description	spring assisted hinge right refrigerator suitable for SAGI		

door bearing



1

Part No.	690686	Ref. No.	36G2810
description	bush for door hinge		
For models:	AF1L7, AF1L7A, AF1L7M, AM03LT7, AM03LT7A, AM03LT7M, AM1L7, AM1L7A, AM1L7M, AM1LT7, AM1LT7A, AM1LT7M, AT1L7, AT1L7A, AT1L7M, EKP, EKP218, EKP21C, EKPV, EKV, EKV218, EKV21C, EKVV, F40, F40B, F40CP, F40CPX, F40PLA, F40PLE, F40X, K100, K100SL, K100SLV, K100X, K100XA, K160PS, K160PZ, K160SL, K200PS		



1

Part No.	690742	Ref. No.	36D4610
description	bush for door hinge		
For models:	EM1A, EM1A-2, EM1A-2A, EM1A-2X, EM1A-A, EM1A-X, EM1B, EM1B-2, EM1B-2A, EM1B-2X, EM1B-4, EM1B-4A, EM1B-4X, EM1B-A, EM1B-X, EM1C, EM1C-2, EM1C-2A, EM1C-2X, EM1C-4, EM1C-4A, EM1C-4X, EM1C-6, EM1C-6A, EM1C-6X, EM1C-A, EM1C-X, EXM1A, EXM1A-2, EXM1A-2A, EXM1A-2X, EXM1A-A, EXM1A-X, EXM1B, EXM1B-2, EXM1B-2A, EXM1B-2X, EXM1B-4, EXM1B-4A, EXM1B-4X, EXM1B-A, EXM1B-X, EXM1C, EXM1C-2, EXM1C-2A, EXM1C-2X, EXM1C-4, EXM1C-4A, EXM1C-4X, EXM1C-6...(Other models you can see in the webshop)		



1

Part No.	690743	Ref. No.	36D4700
description	bush for door hinge		
For models:	KM1A, KM1A-11, KM1A-11A, KM1A-11X, KM1A-2, KM1A-2A, KM1A-2X, KM1A-4, KM1A-4A, KM1A-4X, KM1A-A, KM1A-X, KM1B, KM1B-11, KM1B-11A, KM1B-11X, KM1B-2, KM1B-22, KM1B-22A, KM1B-22X, KM1B-2A, KM1B-2X, KM1B-4, KM1B-4A, KM1B-4X, KM1B-6, KM1B-6A, KM1B-6X, KM1B-A, KM1B-X, KM1C, KM1C-11, KM1C-11A, KM1C-11X, KM1C-2, KM1C-2A, KM1C-2X, KM1C-4, KM1C-4A, KM1C-4X, KM1C-6, KM1C-6A, KM1C-6X, KM1C-8, KM1C-8A, KM1C-8X, KM1C-A, KM1C-X, TE1A, TE1A-11...(Other models you can see in the webshop)		





1

Part No.	695571	Ref. No.	36M0090
description	bush for door hinge		
For models:	CD150CP, CD702, CD70B2, DMG102, DMG102-OP141, DMG82, DMG82-OP141, E12004, E1200B4, E125-4, E125B-4, E125BX-4, E125X-4, E6002, E600B2, E60-2, E60B-2, E60BX-2, E60X-2, GS140BN2, GS140CP, GS652, GS65BCP, GS65NB, GS65NCP, GS65NN, IMFEB, IMFEB-OP141, IMFEG, IMFEN, IMFEN-OP141, IMSFEB, IMSFEN, KFSD2B2, KFSD2B2-OP141, KFSD2N2, KFSD2N2-OP141, KFSDR2B2-OP141, KFSDR2N2-OP141, KFSE2B2, KFSE2B2-OP141, KFSE2N2, KFSE2N2-OP141, KFSE2B2, KFSE2B2-OP141, KFSE2N2-OP141, N135-3, N135-4, N65-2, N65NB...(Other models you can see in the webshop)		





			
1			
Part No.	690795	Ref. No.	36D9490
description	counterpart for spring hinge		
For models:	AF1L, AF2L, AF2S, AF3S, AM1L, AM1LM, AM1LR, AM1LT, AM1LW, AM2L, AM2LR, AM2LW, AM2S, AM2SR, AM2SW, AM3S, AM3SR, AM3SW, AM4S, AM4SR, AM4SW, AT1L, E125, E125-4, E125B, E125B-4, E125BE, E125BPL, E125BPLE, E125BX, E125BX-4, E125BXE, E125E, E125PL, E125PLE, E125SP, E125X, E125X-4, E125XE, E125XSP, E60, E60-2, E60B, E60B-2, E60BE, E60BPL, E60BPLE, E60BX, E60BX-2, E60BXE... (Other models you can see in the webshop)		

			
2			
Part No.	690489	Ref. No.	30T5910
description	hinge L 138mm mounting pos. upper/lower		
For models:	E125-4, E125B-4, E125BX-4, E125X-4, E60-2, E60B-2, E60BX-2, E60X-2, N135-3, N135-4, N65-2, N65NB, N65NN, P135-3, P135-4, P135NN-3, P65-2, SX135-3, SX135-3E, SX135-4, SX135-4E, SX135B-3, SX135B-4, SX135BN2, SX135CP, SX65-2, SX65-2E, SX65B-2, SX65CPB, SX65CPN, SX65NB, SX65NN		

			
1			
Part No.	690793	Ref. No.	30T4780
description	hinge mounting pos. bottom right		
For models:	E125PV, E125PVX, E60PV, E60PVX, F55PV, N135PV, N65GT, N65PV, SX120PV, SX135PV, SX55PV, SX65PV		

			
1			
Part No.	690788	Ref. No.	36M2610
description	hinge mounting pos. centre with bolt		

			
1			
Part No.	700740	Ref. No.	3043190 3088700
description	hinge mounting pos. lower		
For models:	KBF16, KBF16A, KBF16M, KBF21, KBF21A, KBF21M, KBP41P, KBP41X, KBP53G, KBP53V, KBP53X, KBP64G, KBP64V, KBP64X, KBP83G, KBP83V, KBP83X, KBP94G, KBP94V, KBP94X, KBPZ16, KBPZ163A, KBPZ163B, KBPZ163S, KBPZ167A, KBPZ167B, KBPZ167S, KBPZ20, KBPZ203A, KBPZ203B, KBPZ203S, KBPZ207A, KBPZ207B, KBPZ207S, KBPZ25, KBPZ253A, KBPZ253B, KBPZ257A, KBPZ257B, KBS11, KBS11A, KBS11M, KBS16, KBS16A, KBS16M, KBS21, KBS21A, KBS21M, KBSR11, KBSR11A... (Other models you can see in the webshop)		

			
1			
Part No.	700741	Ref. No.	3043180
description	hinge mounting pos. upper		
For models:	KBF16, KBF16A, KBF16M, KBF21, KBF21A, KBF21M, KBP41P, KBP41X, KBP53G, KBP53V, KBP53X, KBP64G, KBP64V, KBP64X, KBP83G, KBP83V, KBP83X, KBP94G, KBP94V, KBP94X, KBPZ16, KBPZ163A, KBPZ163B, KBPZ163S, KBPZ167A, KBPZ167B, KBPZ167S, KBPZ20, KBPZ203A, KBPZ203B, KBPZ203S, KBPZ207A, KBPZ207B, KBPZ207S, KBPZ25, KBPZ253A, KBPZ253B, KBPZ257A, KBPZ257B, KBS11, KBS11A, KBS11M, KBS16, KBS16A, KBS16M, KBS21, KBS21A, KBS21M, KBSR11, KBSR11A... (Other models you can see in the webshop)		

			
1			
Part No.	690787	Ref. No.	30T1980
description	hinge mounting pos. upper left		

			
1			
Part No.	690794	Ref. No.	30T4800
description	hinge mounting pos. upper left		
For models:	E125PV, E125PVX, N135PV, SX120PV, SX135PV		

			
1			
Part No.	690790	Ref. No.	30T1080
description	hinge mounting pos. upper right		

			
1			
Part No.	690746	Ref. No.	30T5900
description	hinge bearing mounting pos. centre with bolt		
For models:	E125-4, E125B-4, E125BX-4, E125X-4, E60-2, E60B-2, E60BX-2, E60X-2, N135-3, N135-4, N65-2, N65NB, N65NN, P135-3, P135-4, P135NN-3, P65-2, SX135-3, SX135-3E, SX135-4, SX135-4E, SX135B-3, SX135B-4, SX135BN2, SX135CP, SX65-2, SX65-2E, SX65B-2, SX65CPB, SX65CPN, SX65NB, SX65NN		

1

Part No.	690741	Ref. No.	30T6230
description	hinge bearing mounting pos. lower with bolt		
For models:	KM1A, KM1A-11, KM1A-11A, KM1A-11X, KM1A-2, KM1A-2A, KM1A-2X, KM1A-4, KM1A-4A, KM1A-4X, KM1A-A, KM1A-X, KM1B, KM1B-11, KM1B-11A, KM1B-11X, KM1B-2, KM1B-22, KM1B-22A, KM1B-22X, KM1B-2A, KM1B-2X, KM1B-4, KM1B-4A, KM1B-4X, KM1B-6, KM1B-6A, KM1B-6X, KM1B-A, KM1B-X, KM1C, KM1C-11, KM1C-11A, KM1C-11X, KM1C-2, KM1C-2A, KM1C-2X, KM1C-4, KM1C-4A, KM1C-4X, KM1C-6, KM1C-6A, KM1C-6X, KM1C-8, KM1C-8A, KM1C-8X, KM1C-A, KM1C-X, TE1A, TE1A-11...(Other models you can see in the webshop)		



1

Part No.	690755	Ref. No.	30T1950
description	hinge bearing mounting pos. lower with bolt		



1

Part No.	690749	Ref. No.	36M2740
description	hinge bearing mounting pos. lower without bolt		
For models:	K160GPZ, K160PS, K160PZ, K160SL, K160XPZ, K200PS		



1

Part No.	690672	Ref. No.	30T5970
description	hinge bearing mounting pos. upper left with bolt		
For models:	E125PV, E125PVX, N135PV, SX120PV, SX135PV		



1

Part No.	690792	Ref. No.	30T4810
description	hinge bearing mounting pos. upper left with bolt		



1

Part No.	690671	Ref. No.	30T5800
description	hinge bearing mounting pos. upper right with bolt		
For models:	E125PV, E125PVX, E60PV, E60PVX, F55PV, N135PV, N65GT, N65PV, SX120PV, SX135PV, SX55PV, SX65PV		



1

Part No.	690748	Ref. No.	36M2730
description	hinge bearing mounting pos. upper right with bolt		
For models:	K160GPZ, K160PS, K160PZ, K160SL, K160XPZ, K200PS		



1

Part No.	690740	Ref. No.	30T6220
description	hinge bearing mounting pos. upper with bolt		
For models:	KM1A, KM1A-11, KM1A-11A, KM1A-11X, KM1A-2, KM1A-2A, KM1A-2X, KM1A-4, KM1A-4A, KM1A-4X, KM1A-A, KM1A-X, KM1B, KM1B-11, KM1B-11A, KM1B-11X, KM1B-2, KM1B-22, KM1B-22A, KM1B-22X, KM1B-2A, KM1B-2X, KM1B-4, KM1B-4A, KM1B-4X, KM1B-6, KM1B-6A, KM1B-6X, KM1B-A, KM1B-X, KM1C, KM1C-11, KM1C-11A, KM1C-11X, KM1C-2, KM1C-2A, KM1C-2X, KM1C-4, KM1C-4A, KM1C-4X, KM1C-6, KM1C-6A, KM1C-6X, KM1C-8, KM1C-8A, KM1C-8X, KM1C-A, KM1C-X, TE1A, TE1A-11...(Other models you can see in the webshop)		



1

Part No.	690684	Ref. No.	35V7760
description	hinge bearing mounting pos. upper without bolt		
For models:	F40, F40B, F40CP, F40CPX, F40PLA, F40PLE, F40X		



1

Part No.	690688	Ref. No.	35V8800
description	hinge bearing mounting pos. upper without bolt		
For models:	F40EV, F40EVP, F40PLPV, F40PV		





			
1			
Part No.	690571	Ref. No.	30T5810
description	hinge bearing with bolt suitable for SAGI		
For models:	E125, E125B, E125BE, E125BPL, E125BPLE, E125BX, E125BXE, E125E, E125PL, E125PLE, E125SP, E125X, E125XE, E125XSP, E60, E60B, E60BE, E60BPL, E60BPLE, E60BX, E60BXE, E60E, E60PL, E60PLE, E60SP, E60X, E60XE, E60XSP, F120, F120B, F120NN, F120PL, F120PV, F120SP, F55, F55B, F55PL, F55SP, N135, N135-3, N135B, N135BN, N135BPS, N135NN, N135PS, N65, N65B, N65BPS, N65PS, P135...(Other models you can see in the webshop)		

			
1			
Part No.	690751	Ref. No.	30T2050 30T2051
description	hinge bearing with bolt suitable for SAGI		
For models:	K160GPZ, K160PS, K160PZ, K160SL, K160XPZ, K200PS		

accessories

miscellaneous

			
1			
Part No.	690689	Ref. No.	35X3460
description	spacer ring		
For models:	F40EV, F40EVP, F40PLPV, F40PV		



			
1			
Part No.	690691	Ref. No.	36C2440
description	spacer ring		
For models:	F40EV, F40EVP, F40PLPV, F40PV		

pullouts

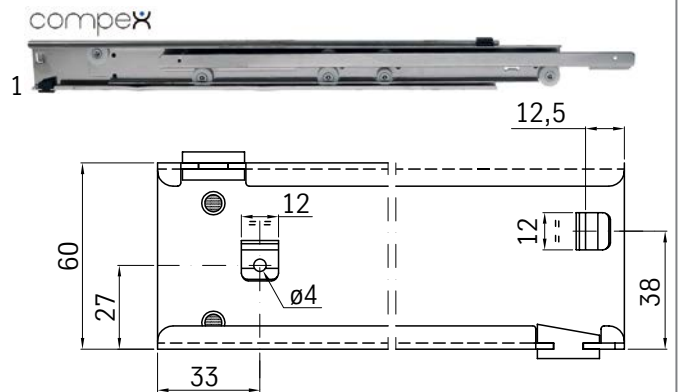

drawer slides

universal

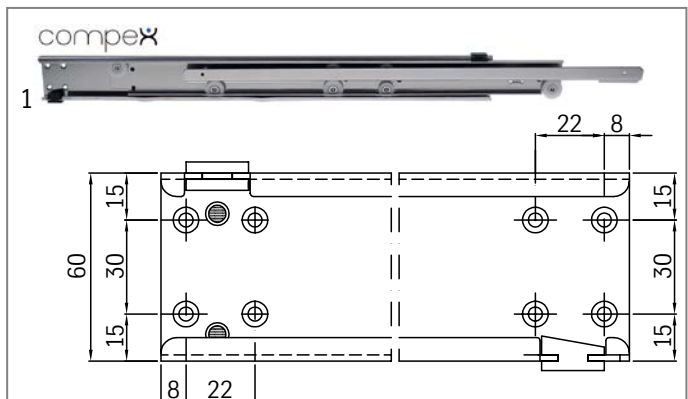

Part No.	696714 ¹	Ref. No.	36M8080 36M8090
description	drawer slide L 550mm pull-out length 610mm total length 1160mm Qty 1 pair capacity 50kg W 16mm H 60mm SS telescopic		
For models:	CD150CP, CD70CP, KBSR11, KBSR11A, KBSR11M, KBSR16, KBSR16A, KBSR16M, KIA11, KIA11A, KIA11M, KIA13, KIA13A, KIA13M, KIA2, KIA2A, KIA2M, KIB11, KIB11A, KIB11M, KIB13, KIB13A, KIB13M, KIB2, KIB22, KIB22A, KIB22M, KIB2A, KIB2M, KIB4, KIB4A, KIB4M, KIC11, KIC11A, KIC11M, KIC13, KIC13A, KIC13M, KIC2, KIC22, KIC22A, KIC22M, KIC2A, KIC2M, KIC4, KIC4A, KIC4AM, KIRA, KIRA-OP141, KIRA2...(Other models you can see in the webshop)		
spare parts for	696714		
	Part No.	690750	Ref. No. —
	stop for telescopic rail L 20mm plastic H 12mm D 9mm		
	Part No.	696333	Ref. No. —
	stop for telescopic rail L 20mm plastic H 15mm D 8mm		



¹multiple slide (60mm more than nominal length)

Part No.	690752 ¹	Ref. No.	36M2700 36M2710 36M4920 36M4940
description	drawer slide L 600mm pull-out length 660mm total length 1260mm Qty 1 pair capacity 45kg H 60mm SS telescopic		
spare parts for	690752		
	Part No.	690750	Ref. No. —
	stop for telescopic rail L 20mm plastic H 12mm D 9mm		
	Part No.	696333	Ref. No. —
	stop for telescopic rail L 20mm plastic H 15mm D 8mm		

¹multiple slide (60mm more than nominal length)



compeX

Part No.	690744 ¹	Ref. No.	36M5380 36M5390
description	drawer slide L 600mm pull-out length 660mm total length 1260mm Qty 1 pair capacity 45kg W 17mm H 60mm mounting pos. right/left SS telescopic		
For models:	EM1A-2, EM1A-2A, EM1A-2X, EM1B-2, EM1B-2A, EM1B-2X, EM1B-4, EM1B-4A, EM1B-4X, EM1C-2, EM1C-2A, EM1C-2X, EM1C-4, EM1C-4A, EM1C-4X, EM1C-6, EM1C-6A, EM1C-6X, EXM1A-2, EXM1A-2A, EXM1A-2X, EXM1B-2, EXM1B-2A, EXM1B-2X, EXM1B-4, EXM1B-4A, EXM1B-4X, EXM1C-2, EXM1C-2A, EXM1C-2X, EXM1C-4, EXM1C-4A, EXM1C-4X, EXM1C-6, EXM1C-6A, EXM1C-6X, KM1A, KM1A-11, KM1A-11A, KM1A-11X, KM1A-2, KM1A-2A, KM1A-2X, KM1A-4, KM1A-4A, KM1A-4X, KM1A-A, KM1A-X, KM1B, KM1B-11...(Other models you can see in the webshop)		
spare parts for	690744		
	Part No.	690750	Ref. No. —
	stop for telescopic rail L 20mm plastic H 12mm D 9mm		
	Part No.	696333	Ref. No. —
	stop for telescopic rail L 20mm plastic H 15mm D 8mm		

¹multiple slide (60mm more than nominal length)

rollers

Part No.	691197	Ref. No.	36G3940
description	roller rollerø 30mm overall width 10mm A 90mm B 10mm plastic		
For models:	AF1L, AF2L, AF2S, AF3S, AM03LT7, AM03LT7A, AM03LT7M, AM1L, AM1LM, AM1LR, AM1LT, AM1LW, AM2L, AM2LR, AM2LW, AM2S, AM2SR, AM2SW, AM3S, AM3SR, AM3SW, AM4S, AM4SR, AM4SW, ECB, ECB218, ECN, ECN218, EKP, EKV, ENB, ENB218, KA12A1E, KA12B1E, KA12B2E, KA12M1E, KA14A1E, KA14B1E, KA14B2E, KA-14M1E, KA16A1E, KA16B1E, KA16B2E, KA16M1E, KA18A1E, KA18B1E, KA18B2E, KA18M1E, KA20A1E, KA20B1E...(Other models you can see in the webshop)		
accessories for	691197		
	Part No.	691126	Ref. No. 36D4440
	bushing H 11mm for roller		

accessories

Part No.	691126	Ref. No.	36D4440
description	bushing H 11mm for roller		
For models:	AF1L, AF2L, AF2S, AF3S, AM03LT7, AM03LT7A, AM03LT7M, AM1L, AM1LM, AM1LR, AM1LT, AM1LW, AM2L, AM2LR, AM2LW, AM2S, AM2SR, AM2SW, AM3S, AM3SR, AM3SW, AM4S, AM4SR, AM4SW, ECB, ECB218, ECN, ECN218, EKP, EKV, ENB, ENB218, KA12A1E, KA12B1E, KA12B2E, KA12M1E, KA14A1E, KA14B1E, KA14B2E, KA-14M1E, KA16A1E, KA16B1E, KA16B2E, KA16M1E, KA18A1E, KA18B1E, KA18B2E, KA18M1E, KA20A1E, KA20B1E...(Other models you can see in the webshop)		

equipment feet and end caps

equipment feet with fixing plate

Part No.	701379	Ref. No.	3137690 36C5600
description	equipment foot tube ø 64mm plate size 80-100mm hole distance 60-80mm H 105-155mm SS size 2 1/2" Qty 1 pcs		
For models:	CD130, CD130B, CD130BN, CD130NN, CD150, CD150B, CD150BB, CD150BN, CD150BR, CD150CP, CD150NN, CD150PV, CD150R, CD60, CD60B, CD70, CD702, CD70B, CD70B2, CD70BPV, CD70BR, CD70CP, CD70PV, CD70PVX, CD70R, CDG150, CDG150B, CDG70, CDG70B, DM101L, DMG101L, DMG102, DMG102-OP141, DMG82, DMG82-OP141, DMS101L, DMS101S, DMS102S, DMS72S, FD140, FD140B, FD-140NN, FD140PV, FD150, FD150B, FD150LT, FD150LTE, FD70, FD70B, FD70LT...(Other models you can see in the webshop)		

Part No.	700709	Ref. No.	36C5550
description	equipment foot tube ø 64mm plate size 80x100mm hole distance 60x80mm H 115-170mm SS size 2 2/3" Qty 1 pcs		
For models:	AS120, AS120B, AS120BN, AS120NN, AS140, AS140B, AS140BN, AS140NN, AS150, AS150B, AS55, AS55B, AS65, AS65B, AS70, AS70B, AX120, AX120B, AX120BN, AX120NN, AX130, AX130B, AX130NN, AX140, AX140B, AX140BN, AX140NN, AX150, AX150B, AX150NN, AX55, AX55B, AX60, AX60B, AX65, AX65B, AX70, AX70B, CD130, CD130B, CD130BN, CD130NN, CD150, CD150B, CD150BB, CD150BN, CD150BR, CD150CP, CD150NN, CD150PV...(Other models you can see in the webshop)		

mechanical components, equipment accessories



1

Part No.	701378	Ref. No.	3145280
description	equipment foot tube ø 64mm plate size 80x100mm hole distance 60x80mm H 150-200mm SS size 2 1/2" Qty 1 pcs		
For models:	IM101SC, IM51H, KBF16, KBF16A, KBF16M, KBF21, KBF21A, KBF21M, KBP41P, KBP41X, KBP53G, KBP53V, KBP53X, KBP64G, KBP64V, KBP64X, KBP83G, KBP83V, KBP83X, KBP94G, KBP94V, KBP94X, KBPZ16, KBPZ163A, KBPZ163B, KBPZ163S, KBPZ167A, KBPZ167B, KBPZ167S, KBPZ20, KBPZ203A, KBPZ203B, KBPZ203S, KBPZ207A, KBPZ207B, KBPZ207S, KBPZ25, KBPZ253A, KBPZ257A, KBPZ257B, KBS10, KBS10A, KBS10M, KBS11, KBS11A, KBS11M, KBS14, KBS14A, KBS14M, KBS16... (Other models you can see in the webshop)		



1

Part No.	700708	Ref. No.	36C4540
description	equipment foot tube ø 64mm plate size 90x90mm hole distance 70x70mm H 140-195mm SS size 2 1/2" Qty 1 pcs		
For models:	RX150, RX150-3, RX150-4, RX150B, RX150BB, RX150BB2, RX150BN, RX150BN2, RX150BR, RX150CP, RX150NCP, RX150NN, RX150PV, RX150R, RX70, RX70-2, RX70B, RX70B-2, RX70BCP, RX70BR, RX70NB, RX70NCP, RX70NN, RX70PV, RX70R		

components



1

Part No.	701090	Ref. No.	36D4000
description	equipment foot tube ø 51mm plate sizemm hole distancemm H 145mm plastic size 2" ET Qty 1 pcs		
For models:	F120, F120B, F120NN, F120PL, F120PV, F120SP, F40, F40B, F40CP, F40CPX, F40EV, F40EVP, F40PLA, F40PLE, F40PLPV, F40PV, F40X, F55, F55B, F55PL, F55PV, F55SP, SX135AX, SX135BAX, SX65AX, SX65BAX		

shelves and shelf rails



grates

universal

without upstand





1

Part No.	970125	Ref. No.	32A2430 36A2430
description	grate W 325mm D 530mm GN 1/1 plastic-coated steel crossing wires 1 white suitable for refrigerator		
For models:	EKP218, EKP21C, EKV218, EKV21C, K160GPZ, K160PZ, K160SL, K160XPZ, QL21RPR, QL21RVR		
accessories for	970125		
	Part No.	690330	Ref. No. —
	rack L 1000mm W 22mm H 4mm aperture 3x8mm hole distance 12.5mm stainless steel		
	Part No.	694700	Ref. No. —
	shelf support L 31/28mm W 22mm H 18mm SS Qty 12 pcs		
	Part No.	694701	Ref. No. —
	shelf support L 31/28mm W 22mm H 17mm SS with hook Qty 12 pcs		



1



Part No.	970132	Ref. No.	36A0131
description	grate W 400mm D 600mm plastic-coated steel crossing wires 1 white suitable for refrigerator		
For models:	F40, F40-OP141, F40CP, F40CP-OP141, F40CPX, F40CPX-OP141, F40PLA, F40PLE, F40PLPV, F40PV, F40PV-OP141, F40X, F40X-OP141		
accessories for	970132		
	Part No.	690330	Ref. No. —
	rack L 1000mm W 22mm H 4mm aperture 3x8mm hole distance 12.5mm stainless steel		
	Part No.	694700	Ref. No. —
	shelf support L 31/28mm W 22mm H 18mm SS Qty 12 pcs		
	Part No.	694701	Ref. No. —
	shelf support L 31/28mm W 22mm H 17mm SS with hook Qty 12 pcs		



with upstand



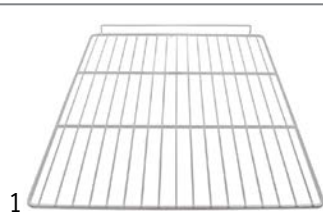

1

Part No.	970527	Ref. No.	36A0990
description	grate W 530mm D 650mm GN 2/1 chrome-plated steel with hinge camp crossing wires 2 suitable for refrigerator		
accessories for	970527		
	Part No.	690330	Ref. No. —
	rack L 1000mm W 22mm H 4mm aperture 3x8mm hole distance 12.5mm stainless steel		
	Part No.	694700	Ref. No. —
	shelf support L 31/28mm W 22mm H 18mm SS Qty 12 pcs		
	Part No.	694701	Ref. No. —
	shelf support L 31/28mm W 22mm H 17mm SS with hook Qty 12 pcs		





1

Part No.	970556	Ref. No.	36A0710 RGP/2-1
description	grate W 530mm D 650mm GN 2/1 plastic-coated steel with hinge camp wire gauge frame 9mm lengthwise wires gauge 5mm crossing wires 2 white suitable for refrigerator		
For models:	AS140, AS140B, AS140BN, AS140NN, AS150, AS150B, AS65, AS65B, AS70, AS70B, AX140, AX140B, AX140BN, AX140NN, AX150, AX150B, AX150NN, AX65, AX65B, AX70, AX70B, CD150, CD150B, CD150BB, CD150BN, CD150BR, CD150CP, CD150NN, CD150PV, CD150R, CD70, CD702, CD70B, CD70B2, CD70BPV, CD70BR, CD70PV, CD70PVSX, CD70R, CDG150, CDG150B, CDG70, CDG70B, E1200, E12004, E1200B, E1200B4, E1200BE, E1200E, E1200PV... (Other models you can see in the webshop)		
accessories for	970556		
	Part No.	690330	Ref. No. —
	rack L 1000mm W 22mm H 4mm aperture 3x8mm hole distance 12.5mm stainless steel		
	Part No.	690332	Ref. No. —
	shelf support L 31/28mm W 22mm H 17mm SS with hook Qty 1 pcs		
	Part No.	694700	Ref. No. —
	shelf support L 31/28mm W 22mm H 18mm SS Qty 12 pcs		
	Part No.	694701	Ref. No. —
	shelf support L 31/28mm W 22mm H 17mm SS with hook Qty 12 pcs		





1

Part No.	970643	Ref. No.	36A3010
description	grate W 555mm D 510mm H 60mm plastic-coated steel with hinge camp crossing wires 1		
For models:	F120, F120B, F120NN, F120PL, F120PV, F120SP, F55, F55B, F55PL, F55SP, SX120, SX120B, SX120BN, SX120NN, SX55, SX55B		
accessories for	970643		
	Part No.	690330	Ref. No. —
	rack L 1000mm W 22mm H 4mm aperture 3x8mm hole distance 12.5mm stainless steel		
	Part No.	694700	Ref. No. —
	shelf support L 31/28mm W 22mm H 18mm SS Qty 12 pcs		
	Part No.	694701	Ref. No. —
	shelf support L 31/28mm W 22mm H 17mm SS with hook Qty 12 pcs		



1

Part No.	970557	Ref. No.	36A3020
description	grate W 555mm D 670mm plastic-coated steel with hinge camp crossing wires 2 suitable for refrigerator		
accessories for	970557		
	Part No.	690330	Ref. No. —
	rack L 1000mm W 22mm H 4mm aperture 3x8mm hole distance 12.5mm stainless steel		
	Part No.	694700	Ref. No. —
	shelf support L 31/28mm W 22mm H 18mm SS Qty 12 pcs		
	Part No.	694701	Ref. No. —
	shelf support L 31/28mm W 22mm H 17mm SS with hook Qty 12 pcs		



gaskets

refrigeration gaskets

plug-in gaskets

profile 9048

We offer custom-made gaskets for this profile

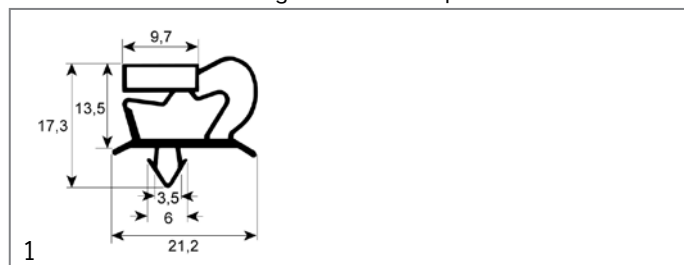

Part No.	900863	Ref. No.	37Q4730
description	refrigeration gasket profile 9048 W 138mm L 373mm plug size		
For models:	KIA11, KIA11A, KIA11M, KIA13, KIA13A, KIA13M, KIB11, KIB11A, KIB11M, KIB13, KIB13A, KIB13M, KIB22, KIB22A, KIB22M, KIC11, KIC11A, KIC11M, KIC13, KIC13A, KIC13M, KIC22, KIC22A, KIC22M, KMRB11, KMRB11A, KMRB11M, KMRC11, KMRC11A, KMRC11M, KTIA11, KTIA11A, KTIA11M, KTIA13, KTIA13A, KTIA13M, KTIB11, KTIB11A, KTIB11M, KTIB13, KTIB13A, KTIB13M, KTIC11, KTIC11A, KTIC11M, KTIC13, KTIC13A, KTIC13M, KTIC22, KTIC22A...(Other models you can see in the webshop)		

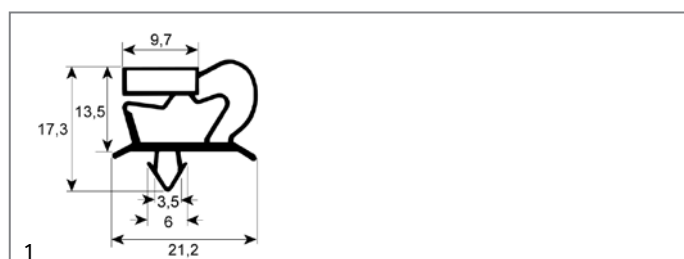

Part No.	900862	Ref. No.	37Q4720
description	refrigeration gasket profile 9048 W 246mm L 373mm plug size		
For models:	KIA2, KIA2A, KIA2M, KIB2, KIB2A, KIB2M, KIB4, KIB4A, KIB4M, KIC2, KIC2A, KIC2M, KIC4, KIC4A, KIC4M, KIRA2, KIRA2-OP141, KIRA2A, KIRA2A-OP141, KIRA2M, KIRA2M-OP141, KIRB2, KIRB2-OP141, KIRB2A, KIRB2A-OP141, KIRB2M, KIRB2M-OP141, KIRB4, KIRB4-OP141, KIRB4A, KIRB4A-OP141, KIRB4M, KIRB4M-OP141, KIRC2, KIRC2-OP141, KIRC2A, KIRC2A-OP141, KIRC2M, KIRC2M-OP141, KIRC4, KIRC4-OP141, KIRC4A, KIRC4A-OP141, KIRC4M, KIRC4M-OP141, KMRA2, KMRA2A, KMRA2M, KMRA4, KMRA4A...(Other models you can see in the webshop)		

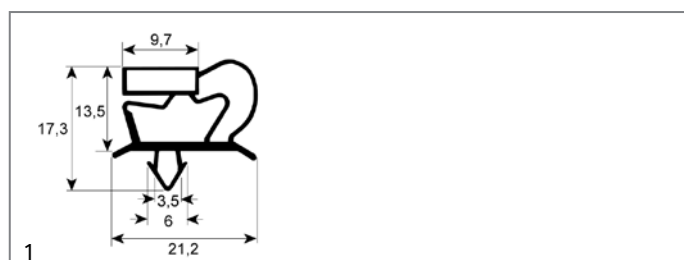

Part No.	900860	Ref. No.	37Q3950
description	refrigeration gasket profile 9048 W 253mm L 373mm plug size		
For models:	EM1A-2, EM1A-2A, EM1A-2X, EM1B-2, EM1B-2A, EM1B-2X, EM1B-4, EM1B-4A, EM1B-4X, EM1C-2, EM1C-2A, EM1C-2X, EM1C-4, EM1C-4A, EM1C-4X, EM1C-6, EM1C-6A, EM1C-6X, EXM1A-2, EXM1A-2A, EXM1A-2X, EXM1B-2, EXM1B-2A, EXM1B-2X, EXM1B-4, EXM1B-4A, EXM1B-4X, EXM1C-2, EXM1C-2A, EXM1C-2X, EXM1C-4, EXM1C-4A, EXM1C-4X, EXM1C-6, EXM1C-6A, EXM1C-6X, JA2, JA2A, JA2M, JB2, JB2A, JB2M, JB4A, JB4M		

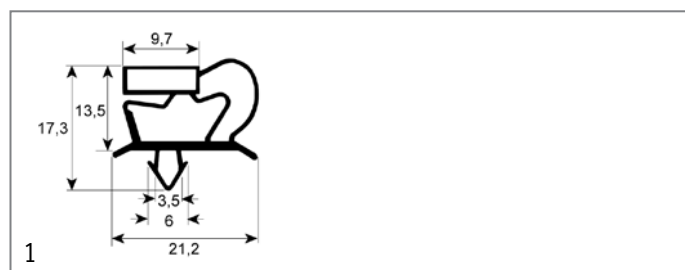

Part No.	900864	Ref. No.	37Q4740
description	refrigeration gasket profile 9048 W 354mm L 373mm plug size		
For models:	KIA11, KIA11A, KIA11M, KIB11, KIB11A, KIB11M, KIB22, KIB22A, KIB22M, KIC11, KIC11A, KIC11M, KIC22, KIC22A, KIC22M, KMRB11, KMRB11A, KMRB11M, KMRC11, KMRC11A, KMRC11M, KTIA11, KTIA11A, KTIA11M, KTIB11, KTIB11A, KTIB11M, KTIC11, KTIC11A, KTIC11M, KTIC22, KTIC22A, KTIC22M, KTRB11, KTRB11A, KTRB11M, KTRC11, KTRC11A, KTRC11M, KUB11, KUB11A, KUB11M, KUC11, KUC11A, KUC11M, KUEB11, KUEB11A, KUEB11M, KWRB11, KWRB11A...(Other models you can see in the webshop)		

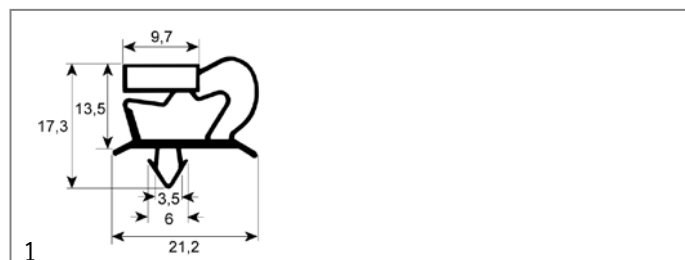

Part No.	900861	Ref. No.	37Q4710
description	refrigeration gasket profile 9048 W 373mm L 570mm plug size		
For models:	KIRA, KIRA-OP141, KIRA2, KIRA2-OP141, KIRA2A, KIRA2A-OP141, KIRA2M, KIRA2M-OP141, KIRAA, KIRAA-OP141, KIRAB, KIRAB-OP141, KIRABA, KIRABM, KIRABM-OP141, KIRAM, KIRAM-OP141, KIRB, KIRB-OP141, KIRB2, KIRB2-OP141, KIRB2A, KIRB2A-OP141, KIRB2M, KIRB2M-OP141, KIRB4, KIRB4-OP141, KIRB4A, KIRB4A-OP141, KIRB4M, KIRB4M-OP141, KIRBA, KIRBA-OP141, KIRBB, KIRBB-OP141, KIRBBA, KIRBBA-OP141, KIRBBM, KIRBBM-OP141, KIRBM, KIRBM-OP141, KIRC, KIRC-OP141, KIRC2, KIRC2-OP141, KIRC2A, KIRC2A-OP141, KIRC2M, KIRC2M-OP141, KIRC4...(Other models you can see in the webshop)		

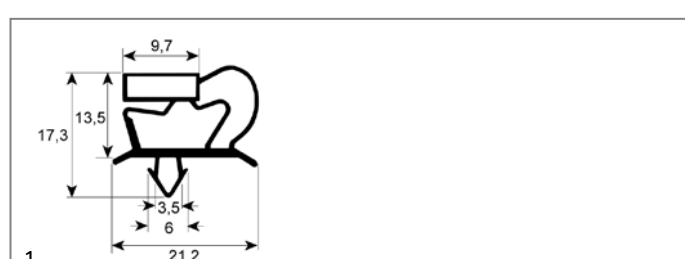

Part No.	900709	Ref. No.	37Q3870
description	refrigeration gasket profile 9048 W 373mm L 580mm plug size		
For models:	EM1A, EM1A-2, EM1A-2A, EM1A-2X, EM1A-A, EM1A-X, EM1B, EM1B-2, EM1B-2A, EM1B-2X, EM1B-4, EM1B-4A, EM1B-4X, EM1B-A, EM1B-X, EM1C, EM1C-2, EM1C-2A, EM1C-2X, EM1C-4, EM1C-4A, EM1C-4X, EM1C-6, EM1C-6A, EM1C-6X, EM1C-A, EM1C-X, EXM1A, EXM1A-2, EXM1A-2A, EXM1A-2X, EXM1A-A, EXM1A-X, EXM1B, EXM1B-2, EXM1B-2A, EXM1B-2X, EXM1B-4, EXM1B-4A, EXM1B-4X, EXM1B-A, EXM1B-X, EXM1C, EXM1C-2, EXM1C-2A, EXM1C-2X, EXM1C-4, EXM1C-4A, EXM1C-4X, EXM1C-6...(Other models you can see in the webshop)		

2 mechanical components, equipment accessories



Part No.	900812	Ref. No.	37Q4490
description	refrigeration gasket profile 9048 W 400mm L 650mm plug size for blast chiller		
For models:	AF1L7, AF1L7A, AF1L7M, AM03LT7, AM03LT7A, AM03LT7M, AM1L7, AM1L7A, AM1L7M, AM1L7T, AM1L7TA, AM1L7TM, AT1L7, AT1L7A, AT1L7M, DC51, DF51M, DM31, DM31A, DM31C, DM31M, DM51, DM51A, DM51C, DM51M, DM51ME, DMG51C, DMG51M, DMG51ME, DMG51ME-OP141, DMS51, DMS51A, DMS51C, DMS51M, DR51, DR51A, DR51M, IF51M, IM51, IM51A, IM51AR, IM51C, IM51CR, IM51M, IM51MR, IM51R, IM51WC, IMS51, IMS51A, IMS51M...(Other models you can see in the webshop)		

Part No.	900710	Ref. No.	37Q5450
description	refrigeration gasket profile 9048 W 655mm L 1500mm plug size		
For models:	AS120, AS120B, AS120BN, AS120NN, AS140, AS140B, AS140BN, AS140NN, AS55, AS55B, AS65, AS65B, AX120, AX120B, AX120BN, AX120NN, AX140, AX140B, AX140BN, AX140NN, AX55, AX55B, AX65, AX65B, CD130, CD130B, CD130BN, CD130NN, CD150, CD150B, CD-150BB, CD150BN, CD150BR, CD150CP, CD150NN, CD150PV, CD150R, CD60, CD60B, CD70, CD70B, CD70BR, CD70CP, CD70R, CDG150, CDG150B, CDG70, CDG70B, FD140, FD140B...(Other models you can see in the webshop)		

Part No.	901207	Ref. No.	37Q3810
description	refrigeration gasket profile 9048 W 429mm L 675mm plug size for blast chiller		
For models:	AF1L, AM1L, AM1LM, AM1LR, AM1LT, AM1LW, AT1L, IM51H		

Part No.	901329	Ref. No.	37Q5460
description	refrigeration gasket profile 9048 W 655mm L 704mm plug size		
For models:	CD150CP, CD702, CD70B2, DMG82, DMG82-OP141, GS140BN2, GS140CP, GS652, GS65BCP, GS65NB, GS65NCP, GS65NN, VD1504, VD150B4, VD702, VD70B2, VD70BCP, VD70NB, VD70NCP, VD70NN		

Part No.	902533	Ref. No.	37Q4140
description	refrigeration gasket profile 9048 W 450mm L 600mm plug size		

Part No.	900706	Ref. No.	37Q4370
description	refrigeration gasket profile 9048 W 660mm L 1610mm plug size		
For models:	AS150, AS150B, AS70, AS70B, AX130, AX130B, AX130NN, AX150, AX150B, AX150NN, AX60, AX60B, AX70, AX70B, GS130, GS130B, GS-130NN, GS150, GS150B, GS150NN, GS60, GS60B, GS70, GS70B, GX130, GX130B, GX130NN, GX150, GX150B, GX150NN, GX60, GX60B, GX70, GX70B, RX150, RX150-3, RX150B, RX150BB, RX150BB2, RX150BN, RX150BN2, RX150BR, RX150CP, RX150NCP, RX150NN, RX150R, RX70, RX70B, RX70BR, RX70R		

Part No.	900712	Ref. No.	37Q1020 37Q4850
description	refrigeration gasket profile 9048 W 595mm L 1590mm plug size		
For models:	E1200, E1200B, E1200BE, E1200E, E125, E125B, E125BE, E125BPL, E125BPPL, E125BX, E125BXE, E125E, E125PL, E125PLE, E125SP, E125X, E125XE, E125XSP, E60, E600, E600B, E600BE, E600E, E60B, E60BE, E60BPL, E60BPPL, E60BX, E60BXE, E60E, E60PL, E60PLE, E60SP, E60X, E60XE, E60XSP		

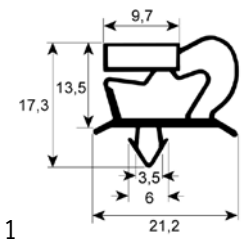
1

Part No.	900350	Ref. No.	37Q2600
description	refrigeration gasket profile 9048 W 670mm L 760mm plug size 1/2 door		
For models:	N135-3, N135-4, N65-2, N65NB, N65NN, P135-3, P135-4, P135NN-3, P65-2, SX135-3, SX135-3E, SX135-4, SX135-4E, SX135B-3, SX135B-4, SX135BN2, SX135CP, SX65-2, SX65-2E, SX65B-2, SX65CPB, SX65CPN, SX65N-3C, SX65NB, SX65NN		

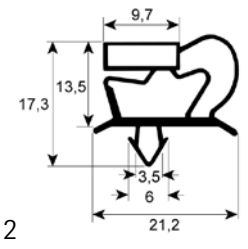

2

Part No.	900351	Ref. No.	37Q2590
description	refrigeration gasket profile 9048 W 672mm L 1587mm plug size door		
For models:	E125PV, E125PVX, F120, F120B, F120NN, F120PL, F120PV, F120SP, F55, F55B, F55PL, F55PV, F55SP, N135, N135-3, N135B, N135BN, N135BPS, N135NN, N135PS, N65, N65B, N65BPS, N65PS, P135, P135-3, P135B, P135BN, P135NN, P135NN-3, P65, P65B, SX120, SX120B, SX120BN, SX120NN, SX135, SX135-3, SX135-3E, SX135AX, SX135B, SX135B-3, SX135BAX, SX135BB, SX135BCP, SX135BE, SX135BN, SX135BN2, SX135BR, SX135CP...(Other models you can see in the webshop)		

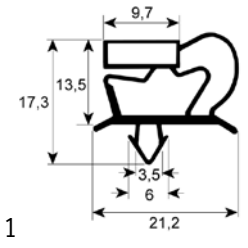

1

Part No.	900328	Ref. No.	37Q1370
description	refrigeration gasket profile 9048 W 675mm L 1525mm plug size glass door		
For models:	E1200PV, E60PV, E60PVX, F40EV, F40EVP, F40PLPV, F40PV		

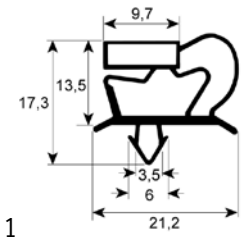

1

Part No.	901206	Ref. No.	37Q3800
description	refrigeration gasket profile 9048 W 675mm L 820mm plug size for blast chiller		
For models:	AF2L, AF2S, AM2L, AM2LR, AM2LW, AM2S, AM2SW		

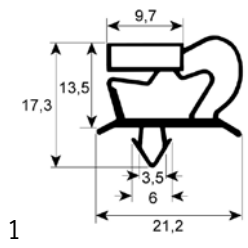

1

Part No.	900326	Ref. No.	37Q1380
description	refrigeration gasket profile 9048 W 685mm L 1600mm plug size glass door		
For models:	N135PV, N65PV, SX120PV, SX135PV, SX55PV, SX65PV		

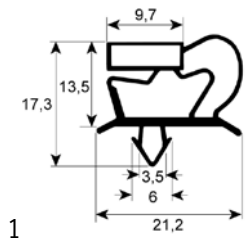

1

Part No.	901205	Ref. No.	37Q5340
description	refrigeration gasket profile 9048 W 690mm L 835mm plug size for blast chiller		
For models:	DM101L, DMG101L, DMS101L, DMS101S, IF101L, IM101L, IM101LR, IM101LW, IM101RAT, IM101S, IM101SC, IM101SR, IMS101L, IMS101S, IR101L, IR101S, TC101L, TC101S, TF101L, TF101S		

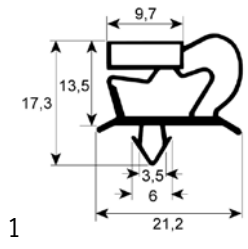

1

Part No.	901204	Ref. No.	37Q5380
description	refrigeration gasket profile 9048 W 941mm L 1002mm plug size for blast chiller		
For models:	DMS102S, DMS72S, IM102S, IM102SC, IM102SR, IM102SW, IM72S, IM72SR, IM72SW, IMS102S, IMS72S, IR72S		

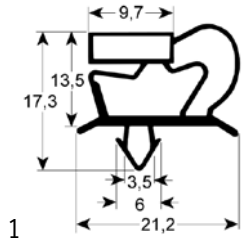

1

Part No.	902258	Ref. No.	N/A
description	refrigeration gasket profile 9048 Wmm L 2500mm plug size		



profile 9046

We offer custom-made gaskets for this profile

Part No.	902515	Ref. No.	3125970
description	refrigeration gasket profile 9046 W 377mm L 395mm plug size		
For models:	KSA, KSA2, KSA2M, KSAM, KSB, KSB2, KSB2M, KSBM		

Part No.	902314	Ref. No.	37Q5510
description	refrigeration gasket profile 9046 W 520mm L 1495mm plug size		
For models:	KAF1B, KAF1B-OP141, KAF1N, KAF1N-OP141, KFSD1B, KFSD1B-OP141, KFSD1N, KFSD1N-OP141, KFSDR1B-OP141, KFSDR1N-OP141		

Part No.	901801	Ref. No.	37Q4470
description	refrigeration gasket profile 9046 W 650mm L 750mm plug size		
For models:	RX150-3, RX150-4, RX150BB2, RX150BN2, RX150CP, RX70-2, RX70B-2, RX70BCP, RX70NB, RX70NCP, RX70NN		

Part No.	902257	Ref. No.	N/A
description	refrigeration gasket profile 9046 Wmm L 2500mm plug size		

profile 9704

We offer custom-made gaskets for this profile

Part No.	902315	Ref. No.	37Q5490
description	refrigeration gasket profile 9704 W 655mm L 1500mm plug size		
For models:	CD70BPV, CD70PV, CD70PVSX, FD140PV, FD65PV, GS140BPV, GS-140PV, GS65BPV, GS65PV, VD150BPV, VD150PV, VD70BPV, VD70PV		

profile 9753

We offer custom-made gaskets for this profile

Part No.	900875	Ref. No.	N/A
description	refrigeration gasket profile 9753 Wmm L 2500mm plug size		

profile 9333

We offer custom-made gaskets for this profile

Part No.	900016	Ref. No.	37Q1890
description	refrigeration gasket profile 9333 W 650mm L 1550mm plug size 1/2 door		

mechanical components, equipment accessories



profile 9012

We offer custom-made gaskets for this profile

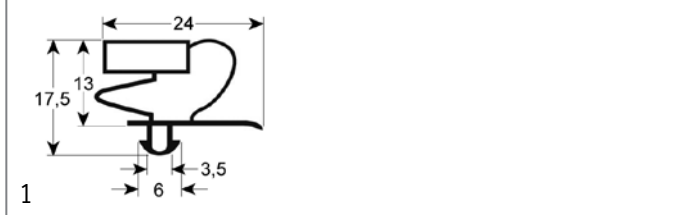

Part No.	900354	Ref. No.	37Q7730
description	refrigeration gasket profile 9012 W 130mm L 367mm plug size drawer size 1/3		
For models:	KM1A-11, KM1A-11A, KM1A-11X, KM1B-11, KM1B-11A, KM1B-11X, KM1B-22, KM1B-22A, KM1B-22X, KM1C-11, KM1C-11A, KM1C-11X, TE1A-11, TE1A-11A, TE1A-11X, TE1A-3, TE1A-3A, TE1A-3X, TE1B-11, TE1B-11A, TE1B-11X, TE1B-22, TE1B-22A, TE1B-22X, TE1B-3, TE1B-3A, TE1B-3X, TE1C-11, TE1C-11A, TE1C-11X, TE1C-22, TE1C-22A, TE1C-22X, TE1C-3, TE1C-3A, TE1C-3X, TE1C-33, TE1C-33A, TE1C-33X, TE1C-3A, TE1C-3X, TM1A-11, TM1A-11A, TM1A-11X, TM1A-3, TM1A-3A, TM1A-3X, TM1B-11, TM1B-11A, TM1B-11X, TM1B-22, TM1B-22A... (Other models you can see in the webshop)		

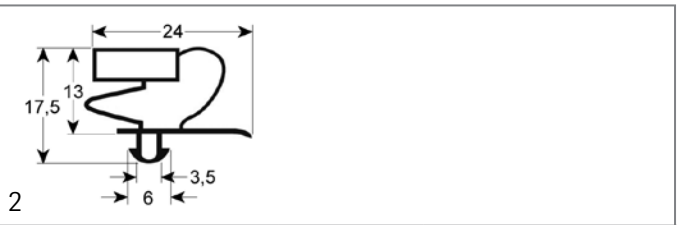

Part No.	900353	Ref. No.	37Q7690
description	refrigeration gasket profile 9012 W 242mm L 367mm plug size drawer size 1/2		
For models:	KM1A, KM1A-11, KM1A-11A, KM1A-11X, KM1A-2, KM1A-2A, KM1A-2X, KM1A-4, KM1A-4A, KM1A-4X, KM1A-A, KM1A-X, KM1B, KM1B-11, KM1B-11A, KM1B-11X, KM1B-2, KM1B-2A, KM1B-2X, KM1B-2A, KM1B-2X, KM1B-4, KM1B-4A, KM1B-4X, KM1B-6, KM1B-6A, KM1B-6X, KM1B-A, KM1B-X, KM1C, KM1C-11, KM1C-11A, KM1C-11X, KM1C-2, KM1C-2A, KM1C-2X, KM1C-4, KM1C-4A, KM1C-4X, KM1C-6, KM1C-6A, KM1C-6X, KM1C-8, KM1C-8A, KM1C-8X, KM1C-A, KM1C-X, TE1A-2, TE1A-2A... (Other models you can see in the webshop)		

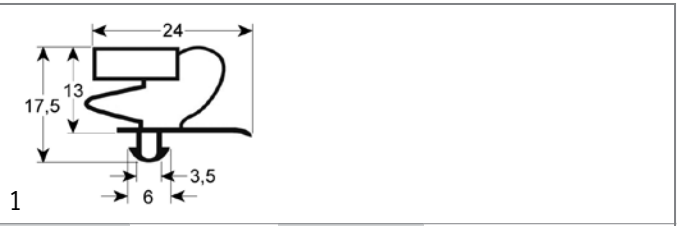

Part No.	900325	Ref. No.	37Q7720
description	refrigeration gasket profile 9012 W 345mm L 362mm plug size drawer size 2/3		
For models:	KM1A-11, KM1A-11A, KM1A-11X, KM1B-11, KM1B-11A, KM1B-11X, KM1B-22, KM1B-22A, KM1B-22X, KM1C-11, KM1C-11A, KM1C-11X, TE1A-11, TE1A-11A, TE1A-11X, TE1B-11, TE1B-11A, TE1B-11X, TE1B-22, TE1B-22A, TE1B-22X, TE1C-11, TE1C-11A, TE1C-11X, TE1C-22, TE1C-22A, TE1C-22X, TE1C-33, TE1C-33A, TE1C-33X, TM1A-11, TM1A-11A, TM1A-11X, TM1B-11, TM1B-11A, TM1B-11X, TM1B-22, TM1B-22A, TM1B-22X, TM1C-11, TM1C-11A, TM1C-11X, TM1C-22, TM1C-22A, TM1C-22X, TM1C-33, TM1C-33A, TM1C-33X		

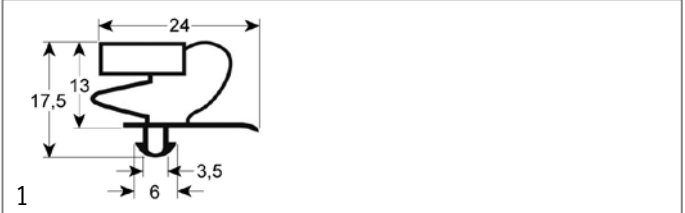

Part No.	900352	Ref. No.	37Q7590
description	refrigeration gasket profile 9012 W 367mm L 567mm plug size door size 1/1		
For models:	KM1A, KM1A-11, KM1A-11A, KM1A-11X, KM1A-2, KM1A-2A, KM1A-2X, KM1A-A, KM1A-X, KM1B, KM1B-11, KM1B-11A, KM1B-11X, KM1B-2, KM1B-22, KM1B-22A, KM1B-22X, KM1B-2A, KM1B-2X, KM1B-4, KM1B-4A, KM1B-4X, KM1B-A, KM1B-X, KM1C, KM1C-11, KM1C-11A, KM1C-11X, KM1C-2, KM1C-2A, KM1C-2X, KM1C-4, KM1C-4A, KM1C-4X, KM1C-6, KM1C-6A, KM1C-6X, KM1C-A, KM1C-X, TE1A, TE1A-11, TE1A-11A, TE1A-11X, TE1A-2, TE1A-2A, TE1A-2X, TE1A-3, TE1A-3A, TE1A-3X, TE1A-A... (Other models you can see in the webshop)		

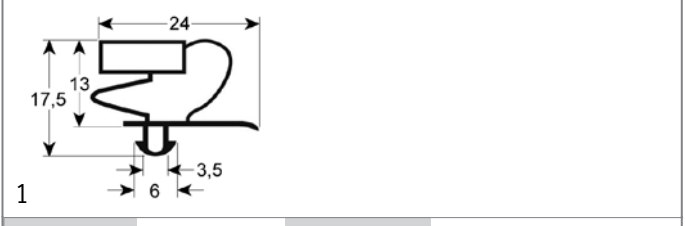

Part No.	900327	Ref. No.	37Q0210
description	refrigeration gasket profile 9012 W 657mm L 1512mm plug size door refrigeration		
For models:	F40, F40B, F40CP, F40CPX, F40PLA, F40PLE, F40X		

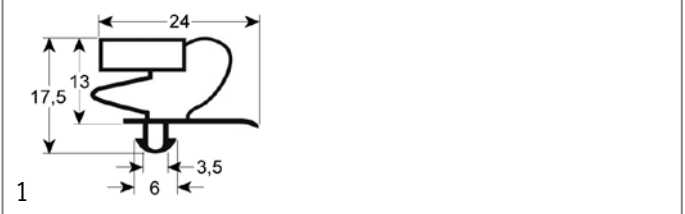

Part No.	900017	Ref. No.	37Q2010
description	refrigeration gasket profile 9012 W 657mm L 747mm plug size door/glass door		

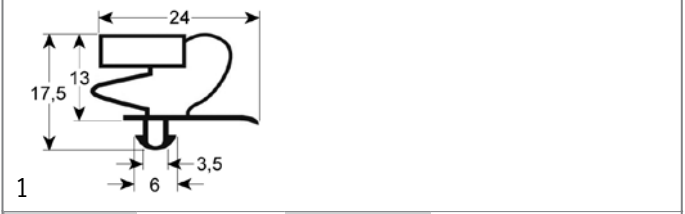

Part No.	902252	Ref. No.	N/A
description	refrigeration gasket profile 9012 Wmm L 2500mm plug size		

2 mechanical components, equipment accessories



screw-in gaskets

profile 9140

We offer custom-made gaskets for this profile



Part No.	900705	Ref. No.	37Q2050
description	refrigeration gasket profile 9140 W 295mm L 380mm external size		
For models:	K160GPZ, K160PZ, K160SL, K160XPZ		

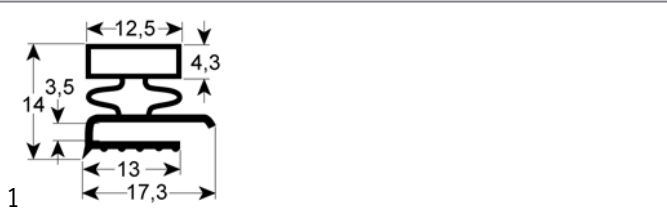

Part No.	900009	Ref. No.	37Q2040
description	refrigeration gasket profile 9140 W 380mm L 610mm external size		
For models:	K160GPZ, K160PZ, K160SL, K160XPZ		

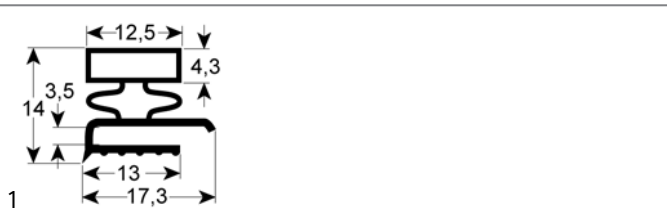

Part No.	900858	Ref. No.	37Q3210
description	refrigeration gasket profile 9140 W 383mm L 531mm external size		
For models:	K100, K100SL, K100SLV, K100X, K100XA		



Part No.	900859	Ref. No.	37Q3250
description	refrigeration gasket profile 9140 W 459mm L 613mm external size		
For models:	K160PS, K200PS		



Part No.	900717	Ref. No.	37Q2380
description	refrigeration gasket profile 9140 W 575mm L 610mm external size		



Part No.	901606	Ref. No.	37Q3320
description	refrigeration gasket profile 9140 W 600mm L 645mm external size		
For models:	EKP, EKP218, EKP21C, EKPV, EKV, EKV218, EKV21C, EKV		



Part No.	901657	Ref. No.	37Q0760
description	refrigeration gasket profile 9140 W 655mm L 1555mm external size		

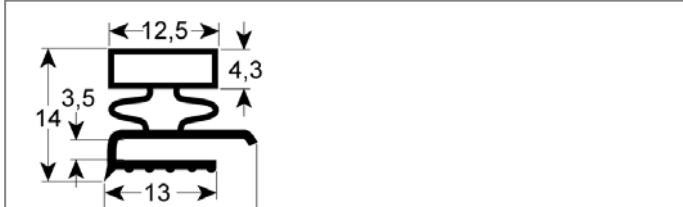

Part No.	902264	Ref. No.	N/A
description	refrigeration gasket profile 9140 Wmm L 2500mm external size		

profile 9106

We offer custom-made gaskets for this profile

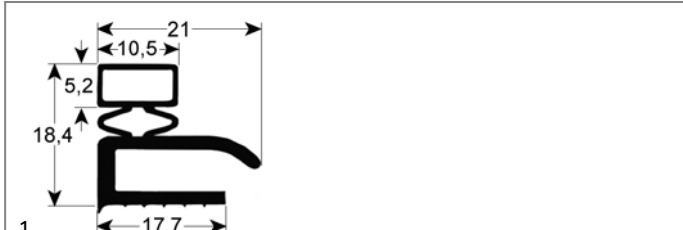

Part No.	902262	Ref. No.	N/A
description	refrigeration gasket profile 9106 Wmm L 2500mm external size		

profile 9207

We offer custom-made gaskets for this profile



Part No.	902277	Ref. No.	N/A
description	refrigeration gasket profile 9207 Wmm L 2500mm external size		



refrigeration cycle components

valves

expansion valves

DANFOSS

valves

type TS2/TES2



1

Part No.	750520	Ref. No.	33A0500
description	expansion valve DANFOSS type TES2 coolant R404a/R507 angled 90° inlet 3/8" SAE outlet 12mm soldering connection 6mm soldering connection p max 34bar capillary pipe 1500mm		
For models:	AM2L, AM2LR, AM2LW, AM2S, AM2SR, AM2SW, AM3S, AM3SR, AM3SW, AM4S, AM4SR, AM4SW, DMS102S, IM102S, IM102SC, IM102SR, IM102SW, IMS102S		



1

Part No.	750504	Ref. No.	33A0870
description	expansion valve DANFOSS type TES2 coolant R404a/R507 angled 90° thermostatically controlled inlet 3/8" SAE outlet 12mm soldering connection 6mm soldering connection p max 34bar -40 up to +10°C capillary pipe 1500mm		
For models:	AF2L, AF2S, AF3S, GR4A-ON141, IR101L, IR101S, IR72S, TC101L, TC101S		

filter driers

miscellaneous



1

Part No.	750177	Ref. No.	33A0180
description	dryer ø 24mm L 155mm connection 6,3/6,3mm		
For models:	AM03LT7, AM03LT7A, AM03LT7M, AS120, AS120B, AS120BN, AS120NN, AS140, AS140B, AS140BN, AS140NN, AS150, AS55, AS55B, AS65, AS65B, AS70B, AX120, AX120B, AX120BN, AX120NN, AX130, AX140, AX140B, AX140BN, AX140NN, AX150, AX55, AX55B, AX60B, AX65, AX65B, AX70B, DM31, DM31A, DM31C, DM31M, E1200, E1200A, E1200E, E1200PV, E125, E125-4, E125E, E125PL, E125PLE, E125PV, E125PVX, E125SP, E125X...(Other models you can see in the webshop)		



1

Part No.	750058	Ref. No.	33A1150
description	dryer ø 24mm L 158mm connection 3.1/6.3mm		
For models:	E60, E60-2, E60E, E60PL, E60PLE, E60X-2, E60XE, F120, F120PL, SKVV, SX120BN		

evaporators

for fridges

producer-specific



1

Part No.	750248	Ref. No.	34E0640
description	evaporator complete with fan		
For models:	AS120, AS140, AS150, AX120, AX130, AX140, AX150		



1

Part No.	750049	Ref. No.	34D0360
description	evaporator L 1340mm W 430mm H 5mm type		
For models:	F120, F120NN, F120PL, F120PV, F120SP, F55, F55PL, F55PV, F55SP, N135, N135-3, N135-4, N135BN, N135NN, N135PS, N135PV, N65, N65-2, N65GT, N65PS, N65PV		



1

Part No.	750247	Ref. No.	32Z3420
description	evaporator L 255mm H 255mm W 50mm		
For models:	TE1A, TE1A-11, TE1A-11A, TE1A-11X, TE1A-2, TE1A-2A, TE1A-2X, TE1A-3, TE1A-3A, TE1A-3X, TE1A-A, TE1A-X, TM1A, TM1A-11, TM1A-11A, TM1A-11X, TM1A-2, TM1A-2A, TM1A-2X, TM1A-3, TM1A-3A, TM1A-3X, TM1A-A, TM1A-X		



1

Part No.	750230	Ref. No.	34D3390
description	evaporator L 360mm W 110mm H 200mm		
For models:	K100, K100SL, K100SLV, K100X, K100XA, WM1A, WM1A-2, WM1A-2A, WM1A-2X, WM1A-A, WM1A-X, WM1B, WM1B-2, WM1B-2A, WM1B-2X, WM1B-4, WM1B-4A, WM1B-4X, WM1B-A, WM1B-X		



1

Part No.	750118	Ref. No.	34D4260
description	evaporator L 410mm W 90mm H 130mm		
For models:	E60, E60-2, E60E, E60PL, E60PLE, E60PV, E60PVX, E60SP, E60X, E60X-2, E60XE, E60XSP, GS140BN2, GS140CP, GS140NCP, GS65BCP, GS65CP, GS65NB, GS65NCP, GS65NN, IMFEN, IMSFEN, RX150BB, RX150BB2, RX150BN, RX150BN2, RX150CP, RX150NCP, RX150NN, RX70, RX70-2, RX70BCP, RX70NB, RX70NCP, RX70NN, RX70PV, RX70R		



1

Part No.	750658	Ref. No.	34E2930
description	evaporator L 415mm W 105mm H 330mm		
For models:	KBF16, KBF16A, KBF16M, KBF21, KBF21A, KBF21M, KBP41P, KBP41X, KBP53G, KBP53V, KBP53X, KBP64G, KBP64V, KBP64X, KBP83G, KBP83V, KBP83X, KBP94G, KBP94V, KBP94X, KBPZ163S, KBPZ167S, KBPZ20, KBPZ203A, KBPZ203B, KBPZ203S, KBPZ207A, KBPZ207B, KBPZ207S, KBPZ25, KBPZ253A, KBPZ253B, KBPZ257A, KBPZ257B, KBS16, KBS16A, KBS16M, KBS21, KBS21A, KBS21M, KBSR16, KBSR16A, KBSR16M, KBSR21, KBSR21A, KBSR21M, KIB, KIB11, KIB11A, KIB11M...(Other models you can see in the webshop)		

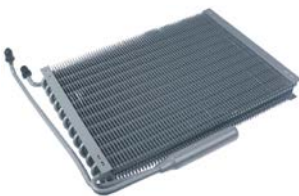

1

Part No.	750069	Ref. No.	34D7670
description	evaporator L 420mm W 47mm H 300mm		
For models:	JA, JA2, JA2A, JA2M, JAA, JAM, JB, JB2, JB2A, JB2M, JB4A, JB4M, JBA, JBM		



1

Part No.	750000	Ref. No.	34D4300
description	evaporator L 730mm W 90mm H 130mm		
For models:	E125, E125-4, E125E, E125PL, E125PLE, E125PV, E125PVX, E125SP, E125X, E125X-4, E125XE, E125XSP, RX150, RX150-3, RX150-4, RX-150PV, RX150R		

condensers

condensers



1

Part No.	605131	Ref. No.	34D4831
description	condenser W 260mm D 110mm H 260mm		
For models:	AM03LT7, AM03LT7A, AM03LT7M, AS70B, AX60B, AX70B, DM31, DM31A, DM31C, DM31M, E600B, E600B2, E600BE, E60BE, E60BPLE, E60BXE, F55B, GX60B, GX70B, SX120BN, SX55B, SX65BAX, SX65BE		



1

Part No.	750543	Ref. No.	34D6180
description	condenser W 275mm D 100mm H 260mm		
For models:	E600, E6002, E600E, E600PV, E60PV, E60PVX, E60SP, E60X, E60XSP, EM1B, EM1B-2, EM1B-2A, EM1B-2X, EM1B-4, EM1B-4A, EM1B-4X, EM1B-A, EM1B-X, EM1C, EM1C-2, EM1C-2A, EM1C-2X, EM1C-4, EM1C-4A, EM1C-4X, EM1C-6, EM1C-6A, EM1C-6X, EM1C-A, EM1C-X, EXM1B, EXM1B-2, EXM1B-2A, EXM1B-2X, EXM1B-4, EXM1B-4A, EXM1B-4X, EXM1B-A, EXM1B-X, EXM1C, EXM1C-2, EXM1C-2A, EXM1C-2X, EXM1C-4, EXM1C-4A, EXM1C-4X, EXM1C-6, EXM1C-6A, EXM1C-6X, EXM1C-A... (Other models you can see in the webshop)		

miscellaneous



1

Part No.	750059	Ref. No.	36Z6471
description	evaporation tray for condenser L 440mm W 357mm		
For models:	N135BN, N65B, N65BPS, P135BN, P65B, SX135BB, SX135BCP, SX135BN, SX65B, SX65B-2, SX65BAX, SX65BE, SX65BR		

evaporation and condensing trays

evaporation trays



1

Part No.	750716	Ref. No.	36Z0300
description	evaporation tray L 610mm W 295mm H 50mm		
For models:	AF1L, AF1L7, AF1L7A, AF1L7M, AF2L, AF2S, AM03LT7, AM03LT7A, AM03LT7M, AM1L, AM1L7, AM1L7A, AM1L7M, AM1LM, AM1LR, AM1LT, AM1LT7, AM1LT7A, AM1LT7M, AM1LW, AM2L, AM2LR, AM2LW, AM2S, AM2SR, AM2SW, AT1L, AT1L7, AT1L7A, AT1L7M, DC51, DF51M, DM101L, DM31, DM31A, DM31C, DM31M, DM51, DM51A, DM51C, DM51M, DM51ME, DMG101L, DMG51C, DMG51M, DMG51ME, DMG-51ME-OP141, DMS101L, DMS101S, DMS51... (Other models you can see in the webshop)		

GASTROPARTS.COM



© 2020 Gastroparts Sp. J. All rights reserved.