



GASTROPARTS

Mobile-Containing

[EN] Equipment

[DE] Geräte

[ES] Aparatos

[FR] Équipement

[IT] Attrezzature

[PL] Urządzenia

[RU] Оборудование

✉ gastroparts@gastroparts.com

☎ tel. +48 56 657 00 66

📘 fb.com/gastroparts.global

GASTROPARTS.COM







heating elements

heating elements for plate warmers

| | | | |
|---|--|-----------------|--------|
| 1  | | | |
| Part No. | 418305 | Ref. No. | 957418 |
| description | heating element 200W 230V L 442mm W 38mm heating circuits 1 connection male faston 6.3mm dry heating element tube ø 8.5mm connection length 23mm | | |

| | | | |
|---|---|-----------------|--------------------------|
| 1  | | | |
| Part No. | 418304 | Ref. No. | 957400 |
| description | heating element 400W 230V 2 hole fixing thread M14x1.25 L 132mm W 126mm H 46mm heating circuits 1 connection male faston 6.3mm L1 110mm L2 22mm immersion heater tube ø 8mm mounting distance 100mm | | |
| accessories for | 418304 | | |
| |  | Part No. | 521101 Ref. No. — |
| | nut thread M14x1.5 H 5mm WS 19 SS Qty 1 pcs | | |

heating elements for heated trolleys

| | | | |
|---|--|-----------------|--------|
| 1  | | | |
| Part No. | 418307 | Ref. No. | 957500 |
| description | heating element 1600W 230V L 555mm W 140mm connection male faston 6.3mm dry heating element tube ø 8.5mm heating circuits 1 connection length 22mm | | |



| | | | |
|---|---|-----------------|--------|
| 1  | | | |
| Part No. | 418308 | Ref. No. | 957460 |
| description | heating element 1600W 230V L 685mm W 53mm connection male faston 6.3mm dry heating element tube ø 8.5mm heating circuits 1 connection distance 45mm | | |

| | | | |
|---|--|-----------------|--------|
| 1  | | | |
| Part No. | 418306 | Ref. No. | 957420 |
| description | heating element 600W 230V L 355mm W 40mm connection male faston 6.3mm dry heating element tube ø 8.5mm heating circuits 1 connection distance 32mm | | |

heater battery

| | | | |
|--|--|-----------------|--------|
| 1  | | | |
| Part No. | 415121 | Ref. No. | 957230 |
| description | heater battery mounting distance 185mm W 40mm H 35mm 2000W 230V heating circuits 2 connection cable cable length 150mm L 192mm | | |

heating elements for convection

| | | | |
|--|--|-----------------|--------------------------|
| 1  | | | |
| Part No. | 415123 | Ref. No. | 957226 |
| description | heating element 1750W 220V heating circuits 1 ID ø 186mm ED ø 199mm L 222mm H 29mm L1 14mm W1 30mm H1 9mm H2 20mm flange length 70mm flange width 22mm hole distance 56mm connection male faston 6.3mm tube ø 6.3mm convection heating element hole ø 5mm rectangular flange | | |
| accessories for | 415123 | | |
| |  | Part No. | 510368 Ref. No. — |
| | gasket L 70mm W 23.5mm hole ø 5mm hole distance 56mm FIBER thickness 2mm for heating element | | |

thermostats

bi-metal thermostats

| | | | |
|---|---------------------|-----------------|--------|
| bi-metal thermostats | | | |
| 1  | | | |
| Part No. | 390518 | Ref. No. | 957130 |
| description | bi-metal thermostat | | |



control and safety thermostats

EGO

control thermostats

55.13_ series



| | | | |
|-----------------|--------|-----------------|--------|
| Part No. | 375744 | Ref. No. | 957050 |
|-----------------|--------|-----------------|--------|

| | |
|--------------------|---|
| description | thermostat t.max. 120°C temperature range 30-120°C 1-pole 1NO 16A probe ø 6mm probe L 85mm capillary pipe 2970mm capillary pipe isolated 2950mm gland nut shaft ø 6x4.6mm shaft L 18mm shaft position° shaft position upper rotation 270° |
|--------------------|---|

switches and momentary switches

rocker/momentary rocker switches

19x13mm



| | | | |
|-----------------|---------------------|-----------------|--------|
| Part No. | 347513 ¹ | Ref. No. | 957110 |
|-----------------|---------------------|-----------------|--------|

| | |
|--------------------|--|
| description | rocker switch mounting measurements 19x13mm green 2NO 250V 10A illuminated connection male faston 2.8mm ambient temperature max. 85/55°C protection IP40 |
|--------------------|--|

¹illuminated

30x22mm



| | | | |
|-----------------|--------|-----------------|---------|
| Part No. | 347531 | Ref. No. | 95.7041 |
|-----------------|--------|-----------------|---------|

| | |
|--------------------|--|
| description | rocker switch mounting measurements 30x22mm green 2NO 250V 20A illuminated 0-1 connection male faston 6.3mm ambient temperature max. 125/55°C protection IP65 with rubber collar |
|--------------------|--|

keypads

control panel



| | | | |
|--------------------|-------------------------------------|-----------------|-------------------------|
| Part No. | 401410 | Ref. No. | 95.7000.SPARE 957010 |
| description | switch panel L 210mm W 110mm H 10mm | | |

fans

cross flow fans

COPREL

with moulded coils



| | | | |
|-----------------|--------|-----------------|--------|
| Part No. | 601456 | Ref. No. | 957220 |
|-----------------|--------|-----------------|--------|

| | |
|--------------------|---|
| description | cross flow fan roller ø 45mm roller length 180mm laminated core thickness 15mm motor position right 230V/50Hz 26W universal bearing silicone connection male faston 6.3mm -30 up to +100°C 230V 50/60Hz |
|--------------------|---|

accessories for cross flow fans

heater battery



| | | | |
|-----------------|--------|-----------------|--------|
| Part No. | 415121 | Ref. No. | 957230 |
|-----------------|--------|-----------------|--------|

| | |
|--------------------|--|
| description | heater battery mounting distance 185mm W 40mm H 35mm 2000W 230V heating circuits 2 connection cable cable length 150mm L 192mm |
|--------------------|--|



hot air fans

miscellaneous



1

| | | | |
|--------------------|---|-----------------|--------|
| Part No. | 601271 | Ref. No. | 957225 |
| description | hot air fan 220-230V 38W L1 65mm L2 25mm L3 20mm L4 87mm fan wheel ø 150mm FIME type C25X0G14/07CLH | | |

electric accessories

cables

spiral cables



1

| | | | |
|--------------------|--|-----------------|--------|
| Part No. | 550071 | Ref. No. | 957020 |
| description | spiral cable plug type CEE7/7 type E+F 1.5mm ² 3-pole with plug L 500mm expansion 5:1 countries A/D/I black | | |

terminals

terminal blocks



1

| | | | |
|--------------------|---|-----------------|------------------|
| Part No. | 508353 | Ref. No. | 957070 957075 |
| description | lustre terminal 3-pole cross section 4mm ² max. 32A max 750V temp.-resist. 150°C | | |

knobs

producer-specific knobs

MOBILE CONTAINING



1

| | | | |
|--------------------|--|-----------------|---------|
| Part No. | 112695 | Ref. No. | 95.7065 |
| description | knob thermostat t.max. 120°C 0-120°C ø 36mm shaft ø 6x4.6mm shaft flat upper black | | |



1

| | | | |
|--------------------|--|-----------------|--------|
| Part No. | 111903 | Ref. No. | 957060 |
| description | knob thermostat t.max. 120°C 0-120°C ø 39mm shaft ø 6x4.6mm shaft flat upper black rotation 270° | | |



1

| | | | |
|--------------------|--|-----------------|--------|
| Part No. | 111904 | Ref. No. | 957061 |
| description | knob thermostat t.max. 120°C 0-120°C ø 39mm shaft ø 6x4.6mm shaft flat upper black rotation 270° | | |

handles and hand wheels

handle bars

consoles



1

| | | | |
|--------------------|---------------------------------------|-----------------|---------|
| Part No. | 690718 | Ref. No. | 95.8170 |
| description | console for handle rod tube ø 20x20mm | | |



hinges



miscellaneous

| | | | |
|---|--------|-----------------|--------|
|  | | | |
| 1 | | | |
| Part No. | 693472 | Ref. No. | 957014 |
| description | hinge | | |

DERBY RUOTE

with fixing plate

chrome-plated steel

| | | | |
|---|---|-----------------|-------------------|
|  | | | |
| 1 | | | |
| Part No. | 701287 | Ref. No. | 958050 |
| description | swivel castor ø 125mm plate fixing housing chrome-plated sheet steel plate size 95x70mm hole distance 70x50mm capacity 100kg bearing cup-and-cone bearing wheel body polypropylene tread TPE tyres H 162mm wheel width 30mm Qty 1 pcs | | |
| accessories for | 701287 | | |
|  | Part No. | 701286 | Ref. No. — |
| description | swivel castor with swivel brake ø 125mm plate fixing housing chrome-plated sheet steel plate size 95x70mm hole distance 70x50mm capacity 100kg bearing cup-and-cone bearing wheel body polypropylene tread TPE tyres H 162mm wheel width 30mm Qty 1 pcs | | |



TENTE

with fixing plate

chrome-plated steel

| | | | |
|---|--|-----------------|--------|
|  | | | |
| 1 | | | |
| Part No. | 700300 | Ref. No. | 958060 |
| description | swivel castor with swivel brake ø 125mm plates fixing 95x70mm housing zinc-plated sheet steel hole distance 75x50mm capacity 100kg bearing precision ball bearing wheel body polypropylene tread thermoplastic rubber H 160mm wheel width 32mm -20 up to +60°C | | |

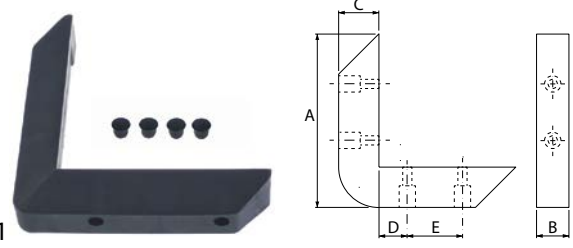
bumper angles

| | | | |
|--|---|-----------------|------------------------|
|  | | | |
| 1 | | | |
| Part No. | 690935 ¹ | Ref. No. | 958000 |
| description | bumper angle outer length 145mm inner length 120mm W 24mm H 30mm mounting distance 70mm hole distance 22.5mm hole ø 3.6mm plastic black | | |
| accessories for | 690935 | | |
|  | Part No. | 690936 | Ref. No. 958350 |
| description | plug for bumper angle ø 9mm L 9.5mm black Qty 1 pcs | | |

¹suitable plug 690936

| | | | |
|---|---|-----------------|--------|
|  | | | |
| 1 | | | |
| Part No. | 690936 | Ref. No. | 958350 |
| description | plug for bumper angle ø 9mm L 9.5mm black Qty 1 pcs | | |

springs

compression springs

| | | | |
|--|---|-----------------|--------|
|  | | | |
| 1 | | | |
| Part No. | 700526 | Ref. No. | 957650 |
| description | compression spring ø 12mm L 36mm wire gauge ø 1.8mm | | |

| | | | |
|--|--|-----------------|--------|
|  | | | |
| 1 | | | |
| Part No. | 700525 | Ref. No. | 957640 |
| description | compression spring ø 8mm L 20mm wire gauge ø 1mm | | |

tension springs

| | | | |
|--|---|-----------------|--------|
|  | | | |
| 1 | | | |
| Part No. | 700523 | Ref. No. | 957610 |
| description | tension spring ø 18.3mm total length 116mm wire gauge ø 1.3mm | | |



ancillary products

clamps

hose clamps

DIN 3017 - W2



| | | | |
|--------------------|---|-----------------|--------|
| Part No. | 520110 | Ref. No. | 958355 |
| description | hose clamp ø 8-12mm width 9mm Qty 10 pcs DIN 3017 | | |

fastening material

fasteners

clamps

hose clamps

DIN 3017 - W2



| | | | |
|--------------------|---|-----------------|--------|
| Part No. | 520110 | Ref. No. | 958355 |
| description | hose clamp ø 8-12mm width 9mm Qty 10 pcs DIN 3017 | | |

GASTROPARTS.COM

