



**GASTROPARTS**

# MKN

- [EN]** Equipment
- [DE]** Geräte
- [ES]** Aparatos
- [FR]** Équipement
- [IT]** Attrezzature
- [PL]** Urządzenia
- [RU]** Оборудование

✉ [gastroparts@gastroparts.com](mailto:gastroparts@gastroparts.com)

☎ tel. +48 56 657 00 66

📘 [fb.com/gastroparts.global](https://fb.com/gastroparts.global)

**GASTROPARTS.COM**




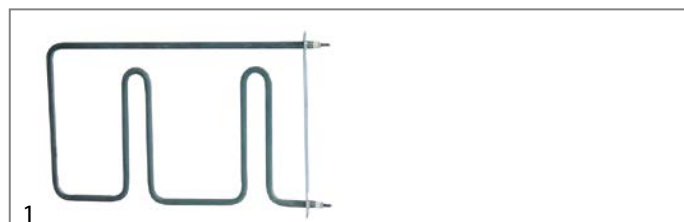


# heating elements

## heating elements for ovens



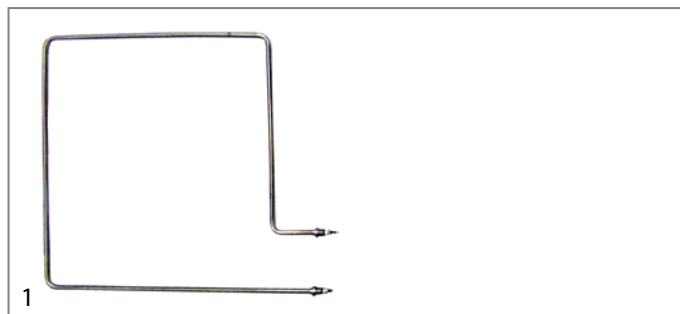
<b>Part No.</b>	415783	<b>Ref. No.</b>	574066
<b>description</b>	heating element 1200W 380V heating circuits 1 L 510mm W 295mm L1 37mm L2 467mm W1 180mm W2 115mm mounting distance 106mm thread M14x1.5 tube ø 8.5mm connection M4 mounting pos. lower-outer dry heating element 2 hole fixing		
<b>accessories for</b>	415783		
	<b>Part No.</b>	510417	<b>Ref. No.</b> —
	flat gasket fibre ED ø 20mm ID ø 14mm thickness 2mm Qty 1 pcs		
	<b>Part No.</b>	520228	<b>Ref. No.</b> —
	tooth lock washer ID ø 15.3mm ED ø 24mm steel Qty 1 pcs for thread M14		
	<b>Part No.</b>	520230	<b>Ref. No.</b> —
	nut thread M14x1.5 H 5mm WS 19 zinc-coated steel Qty 1 pcs		
	<b>Part No.</b>	521101	<b>Ref. No.</b> 113000
	nut thread M14x1.5 H 5mm WS 19 SS Qty 1 pcs		
	<b>Part No.</b>	550262	<b>Ref. No.</b> —
	flat gasket copper ED ø 20mm ID ø 14mm thickness 2mm		



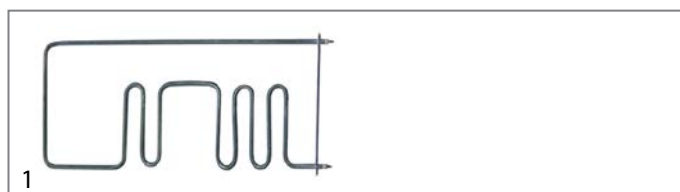
<b>Part No.</b>	416448	<b>Ref. No.</b>	574089
<b>description</b>	heating element 1275W 230V L 325mm W 202mm flange length 225mm flange width 20mm hole distance 219mm tube ø 8.5mm heating circuits 1 hole ø 5.5mm connection M4 mounting pos. lower rectangular flange dry heating element oven		
<b>For models:</b>	0522101-01, 0522101-02, 0522101-03, 0522101-04, 1323208-00, 1323208-01, 1323208-02, 1323208-03, 1323208-04, 1323210-00, 1323210-01, 1323210-02, 1323210-03, 1323210-04, 1323403-00, 1323403K00, 1323506-00, 1323506-01, 1323506A00, 1323506A01, 1323517-00, 1323517A00, 1363403-00, 1363403-01, 1363403-02, 1363403-03, 1363403-04, 1363403-05, 1363415-05, 1422102-01, 1422102-02, 1422102-03, 1422102-04, 1422102-05, 1422104-05, 2123203-01, 2123203-02, 2123203-03, 2123203-04, 2123203-05, 2123203-06, 2123203-07, 2123203-08, 2123203A01, 2123203A02, 2123203A03, 2123203A04, 2123204-01, 2123204-02, 2123204-03... (Other models you can see in the webshop)		



<b>Part No.</b>	415784	<b>Ref. No.</b>	574067
<b>description</b>	heating element 1300W 380V heating circuits 1 L 442mm W 190mm L1 110mm L2 332mm W1 117mm W2 73mm mounting distance 65mm thread M14x1.5 tube ø 8.5mm connection M4 mounting pos. lower-inner dry heating element 2 hole fixing		
<b>accessories for</b>	415784		
	<b>Part No.</b>	510417	<b>Ref. No.</b> —
	flat gasket fibre ED ø 20mm ID ø 14mm thickness 2mm Qty 1 pcs		
	<b>Part No.</b>	520228	<b>Ref. No.</b> —
	tooth lock washer ID ø 15.3mm ED ø 24mm steel Qty 1 pcs for thread M14		
	<b>Part No.</b>	521101	<b>Ref. No.</b> 113000
	nut thread M14x1.5 H 5mm WS 19 SS Qty 1 pcs		
	<b>Part No.</b>	550262	<b>Ref. No.</b> —
	flat gasket copper ED ø 20mm ID ø 14mm thickness 2mm		



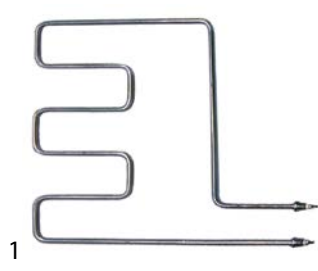





<b>Part No.</b>	415787	<b>Ref. No.</b>	574081
<b>description</b>	heating element 1450W 400V heating circuits 1 L 502mm W 455mm L1 75mm L2 427mm W1 357mm W2 98mm mounting distance 90mm thread M14x1.5 tube ø 8.5mm connection M4 mounting pos. lower-outer 2 hole fixing		
<b>For models:</b>	0522101-00, 1422102-00, 2123203-00, 2123203A00, 2123204-00, 2123204A00, 2163403-00, 2163403-01, 2163406-00, 2163406-01, 2163417-00, 2163420-00		

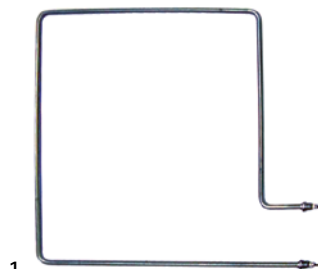







<b>Part No.</b>	415570	<b>Ref. No.</b>	574087
<b>description</b>	heating element 1500W 230V L 470mm W 200mm flange length 225mm flange width 20mm hole distance 214mm tube ø 8.3mm heating circuits 1 hole ø 6mm connection M4 mounting pos. lower rectangular flange dry heating element oven		
<b>For models:</b>	0522102-01, 0522102-02, 0522102-03, 0522102-04, 0722101-06, 1422101-01, 1422101-02, 1422101-03, 1422101-04, 1422101-05, 1422101-06, 1422106-05, 1422106-06, 1422301-01, 2023114-00, 2023118-00, 2023119-00, 2023203-01, 2023203-02, 2023203-03, 2023203-04, 2023203-05, 2023203-06, 2023203-07, 2023203A01, 2023203A02, 2023203A03, 2023205-01, 2023205-02, 2023205-03, 2023205-04, 2023205-05, 2023205-06, 2023205-07, 2023205A01, 2023205A02, 2023205A03, 2023207-00, 2023207-01, 2023207-02, 2023207-03, 2023207-04, 2023207-05, 2023406-00, 2023503-02, 2023503-03, 2023503-04, 2023503-05, 2023503-06, 2023503-07... (Other models you can see in the webshop)		

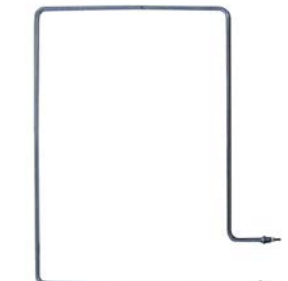
1 electric components

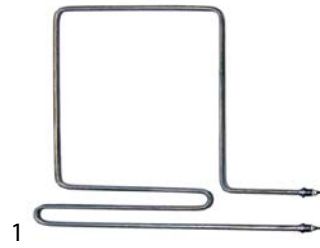







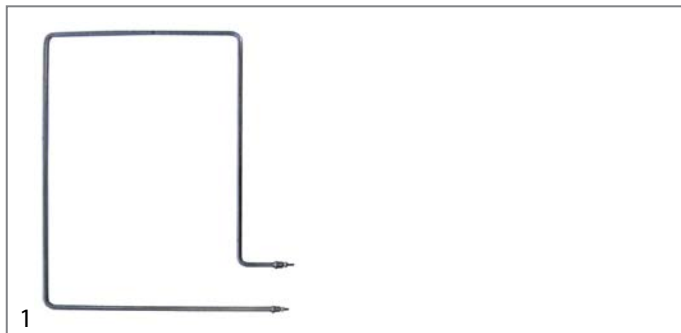
			
1			
<b>Part No.</b>	415786	<b>Ref. No.</b>	574082
<b>description</b>	heating element 1500W 380V heating circuits 1 L 432mm W 392mm L1 135mm L2 302mm W1 322mm W2 70mm mounting distance 61mm thread M14x1.5 tube ø 8.6mm connection M4 mounting pos. upper inner dry heating element oven 2 hole fixing		
<b>For models:</b>	0522101-00, 1422102-00, 2123203-00, 2123203A00, 2123204-00, 2123204A00, 2163403-00, 2163403-01, 2163406-00, 2163406-01, 2163417-00, 2163420-00		
<b>accessories for</b>	415786		
	<b>Part No.</b>	510417	<b>Ref. No.</b> —
	flat gasket fibre ED ø 20mm ID ø 14mm thickness 2mm Qty 1 pcs		
	<b>Part No.</b>	520228	<b>Ref. No.</b> —
	tooth lock washer ID ø 15.3mm ED ø 24mm steel Qty 1 pcs for thread M14		
	<b>Part No.</b>	520230	<b>Ref. No.</b> —
	nut thread M14x1.5 H 5mm WS 19 zinc-coated steel Qty 1 pcs		
	<b>Part No.</b>	521101	<b>Ref. No.</b> 113000
	nut thread M14x1.5 H 5mm WS 19 SS Qty 1 pcs		
	<b>Part No.</b>	550262	<b>Ref. No.</b> —
	flat gasket copper ED ø 20mm ID ø 14mm thickness 2mm		

			
1			
<b>Part No.</b>	415785	<b>Ref. No.</b>	574083
<b>description</b>	heating element 1500W 380V heating circuits 1 L 505mm W 463mm L1 75mm L2 430mm W1 357mm W2 98mm mounting distance 90mm thread M14x1.5 tube ø 8.5mm connection M4 mounting pos. upper outer dry heating element 2 hole fixing		
<b>For models:</b>	0522101-00, 1422102-00, 2123203-00, 2123203A00, 2123204-00, 2123204A00, 2163403-00, 2163403-01, 2163406-00, 2163406-01, 2163417-00, 2163420-00		
<b>spare parts for</b>	415785		
	<b>Part No.</b>	510417	<b>Ref. No.</b> —
	flat gasket fibre ED ø 20mm ID ø 14mm thickness 2mm Qty 1 pcs		
<b>accessories for</b>	415785		
	<b>Part No.</b>	520228	<b>Ref. No.</b> —
	tooth lock washer ID ø 15.3mm ED ø 24mm steel Qty 1 pcs for thread M14		
	<b>Part No.</b>	520230	<b>Ref. No.</b> —
	nut thread M14x1.5 H 5mm WS 19 zinc-coated steel Qty 1 pcs		

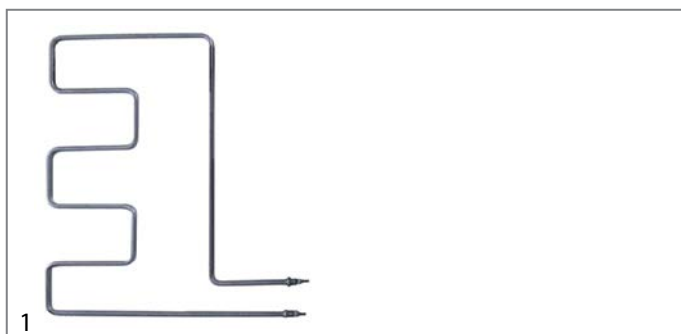
<b>accessories for</b>	415785		
	<b>Part No.</b>	521101	<b>Ref. No.</b> 113000
	nut thread M14x1.5 H 5mm WS 19 SS Qty 1 pcs		
	<b>Part No.</b>	550262	<b>Ref. No.</b> —
	flat gasket copper ED ø 20mm ID ø 14mm thickness 2mm		


			
1			
<b>Part No.</b>	415810	<b>Ref. No.</b>	574068
<b>description</b>	heating element 1500W 400V heating circuits 1 L 495mm W 635mm L1 75mm L2 420mm W1 515mm W2 120mm mounting distance 100mm thread M14x1.5 tube ø 8.5mm connection M4 mounting pos. upper outer 2 hole fixing		
<b>For models:</b>	0522102-00, 1422101-00, 2023203-00, 2023203A00, 2023205-00, 2023205A00, 2023503-00, 2023503-01, 2023503A00, 2023503A01, 2063403-00, 2063403-01, 2063406-00, 2063406-01, 2063415-00, 2063415-01, 2063418-00, 2063418-01, 2063502-00, 2063502-01, 2063507-00, 2063507-01, 2063509-00, 2063509-01, 2083202A00, 2083502B00, 2083502B01, 2083502C00, 2083502C01		





			
1			
<b>Part No.</b>	415788	<b>Ref. No.</b>	574080
<b>description</b>	heating element 1700W 380V heating circuits 1 L 475mm W 386mm L1 140mm L2 295mm L3 40mm W1 320mm W2 66mm mounting distance 58mm thread M14x1.5 tube ø 8.5mm connection M4 mounting pos. lower-inner dry heating element 2 hole fixing		
<b>For models:</b>	0522101-00, 1422102-00, 2123203-00, 2123203A00, 2123204-00, 2123204A00, 2163403-00, 2163403-01, 2163406-00, 2163406-01, 2163417-00, 2163420-00		
<b>accessories for</b>	415788		
	<b>Part No.</b>	510417	<b>Ref. No.</b> —
	flat gasket fibre ED ø 20mm ID ø 14mm thickness 2mm Qty 1 pcs		
	<b>Part No.</b>	520228	<b>Ref. No.</b> —
	tooth lock washer ID ø 15.3mm ED ø 24mm steel Qty 1 pcs for thread M14		
	<b>Part No.</b>	520230	<b>Ref. No.</b> —
	nut thread M14x1.5 H 5mm WS 19 zinc-coated steel Qty 1 pcs		
	<b>Part No.</b>	521101	<b>Ref. No.</b> 113000
	nut thread M14x1.5 H 5mm WS 19 SS Qty 1 pcs		
	<b>Part No.</b>	550262	<b>Ref. No.</b> —
	flat gasket copper ED ø 20mm ID ø 14mm thickness 2mm		

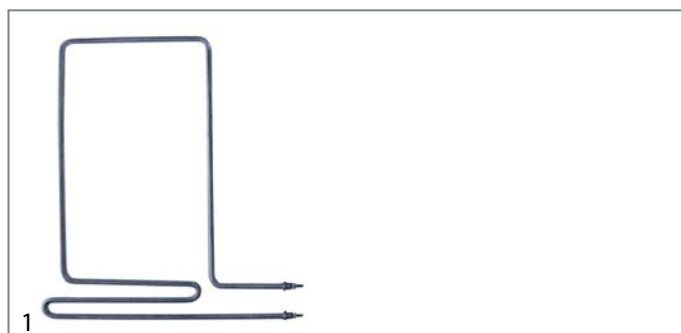


<b>Part No.</b>	415812	<b>Ref. No.</b>	574070 574076
<b>description</b>	heating element 1700W 400V heating circuits 1 L 495mm W 635mm L1 75mm L2 420mm W1 515mm W2 120mm mounting distance 110mm thread M14x1.5 tube ø 8.5mm connection M4 mounting pos. lower-outer dry heating element 2 hole fixing		
<b>For models:</b>	0522102-00, 1422101-00, 2023203-00, 2023203A00, 2023205-00, 2023205A00, 2023503-00, 2023503-01, 2023503A00, 2023503A01, 2063403-00, 2063403-01, 2063406-00, 2063406-01, 2063415-00, 2063415-01, 2063418-00, 2063418-01, 2063502-00, 2063502-01, 2063507-00, 2063507-01, 2063509-00, 2063509-01, 2083202A00, 2083502B00, 2083502B01, 2083502C00, 2083502C01		
<b>accessories for</b>	415812		
	<b>Part No.</b>	510417	<b>Ref. No.</b> —
	flat gasket fibre ED ø 20mm ID ø 14mm thickness 2mm Qty 1 pcs		
	<b>Part No.</b>	520228	<b>Ref. No.</b> —
	tooth lock washer ID ø 15.3mm ED ø 24mm steel Qty 1 pcs for thread M14		
	<b>Part No.</b>	520230	<b>Ref. No.</b> —
	nut thread M14x1.5 H 5mm WS 19 zinc-coated steel Qty 1 pcs		
	<b>Part No.</b>	521101	<b>Ref. No.</b> 113000
	nut thread M14x1.5 H 5mm WS 19 SS Qty 1 pcs		
	<b>Part No.</b>	550262	<b>Ref. No.</b> —
	flat gasket copper ED ø 20mm ID ø 14mm thickness 2mm		



<b>Part No.</b>	415811	<b>Ref. No.</b>	574069
<b>description</b>	heating element 1700W 400V L 447mm W 540mm L1 137mm L2 310mm W1 474mm W2 66mm mounting distance 58mm thread M14x1.5 tube ø 8.5mm connection M4 mounting pos. upper inner 2 hole fixing		
<b>For models:</b>	0522102-00, 1422101-00, 2023203-00, 2023203A00, 2023205-00, 2023205A00, 2023503-00, 2023503-01, 2023503A00, 2023503A01, 2063403-00, 2063403-01, 2063406-00, 2063406-01, 2063415-00, 2063415-01, 2063418-00, 2063418-01, 2063502-00, 2063502-01, 2063507-00, 2063507-01, 2063509-00, 2063509-01, 2083202A00, 2083502B00, 2083502B01, 2083502C00, 2083502C01		
<b>accessories for</b>	415811		
	<b>Part No.</b>	510417	<b>Ref. No.</b> —
	flat gasket fibre ED ø 20mm ID ø 14mm thickness 2mm Qty 1 pcs		

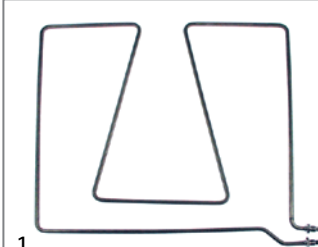




<b>accessories for</b>	415811		
	<b>Part No.</b>	520228	<b>Ref. No.</b> —
	tooth lock washer ID ø 15.3mm ED ø 24mm steel Qty 1 pcs for thread M14		
	<b>Part No.</b>	520230	<b>Ref. No.</b> —
	nut thread M14x1.5 H 5mm WS 19 zinc-coated steel Qty 1 pcs		
	<b>Part No.</b>	521101	<b>Ref. No.</b> 113000
	nut thread M14x1.5 H 5mm WS 19 SS Qty 1 pcs		
	<b>Part No.</b>	550262	<b>Ref. No.</b> —
	flat gasket copper ED ø 20mm ID ø 14mm thickness 2mm		

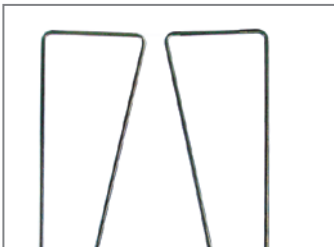







<b>Part No.</b>	415813	<b>Ref. No.</b>	574071
<b>description</b>	heating element 1950W 400V heating circuits 1 L 467mm W 520mm L1 140mm L2 290mm L3 37mm W1 465mm W2 55mm mounting distance 45mm thread M14x1.5 tube ø 8.5mm connection M4 mounting pos. lower-inner dry heating element 2 hole fixing		
<b>For models:</b>	0522102-00, 1422101-00, 2023203-00, 2023203A00, 2023205-00, 2023205A00, 2023503-00, 2023503-01, 2023503A00, 2023503A01, 2063403-00, 2063403-01, 2063406-00, 2063406-01, 2063415-00, 2063415-01, 2063418-00, 2063418-01, 2063502-00, 2063502-01, 2063507-00, 2063507-01, 2063509-00, 2063509-01, 2083202A00, 2083502B00, 2083502B01, 2083502C00, 2083502C01		
<b>accessories for</b>	415813		
	<b>Part No.</b>	510417	<b>Ref. No.</b> —
	flat gasket fibre ED ø 20mm ID ø 14mm thickness 2mm Qty 1 pcs		
	<b>Part No.</b>	520228	<b>Ref. No.</b> —
	tooth lock washer ID ø 15.3mm ED ø 24mm steel Qty 1 pcs for thread M14		
	<b>Part No.</b>	521101	<b>Ref. No.</b> 113000
	nut thread M14x1.5 H 5mm WS 19 SS Qty 1 pcs		
	<b>Part No.</b>	550262	<b>Ref. No.</b> —
	flat gasket copper ED ø 20mm ID ø 14mm thickness 2mm		










			
<b>Part No.</b>	418296	<b>Ref. No.</b>	574138
<b>description</b>	heating element 2000W 230V heating circuits 1 L 554mm W 508mm L1 55mm L2 494mm W1 460mm W2 48mm mounting distance 44mm thread M14x1.5 tube ø 8.5mm connection M4 mounting pos. upper oven heating element 2 hole fixing		
<b>For models:</b>	0522101-04, 1323208-04, 1323210-03, 1323210-04, 1323403-00, 1323403K00, 1323506-00, 1323506-01, 1323506A00, 1323506A01, 1323517-00, 1323517A00, 1363403-03, 1363403-04, 1363403-05, 1363415-05, 1422102-04, 1422102-05, 2123203-08, 2123204-08, 2123208A02, 2123208A03, 2123403-00, 2123403K00, 2123503-06, 2123503-07, 2123503A06, 2123503A07, 2123506-00, 2123506-01, 2123506A00, 2123506A01, 2163403-07, 2163403-08, 2163403-09, 2163406-07, 2163406-08, 2163406-09		
<b>accessories for</b>	418296		
	<b>Part No.</b>	510417	<b>Ref. No.</b> —
	flat gasket fibre ED ø 20mm ID ø 14mm thickness 2mm Qty 1 pcs		
	<b>Part No.</b>	520228	<b>Ref. No.</b> —
	tooth lock washer ID ø 15.3mm ED ø 24mm steel Qty 1 pcs for thread M14		
	<b>Part No.</b>	520230	<b>Ref. No.</b> —
	nut thread M14x1.5 H 5mm WS 19 zinc-coated steel Qty 1 pcs		
	<b>Part No.</b>	521101	<b>Ref. No.</b> 113000
	nut thread M14x1.5 H 5mm WS 19 SS Qty 1 pcs		
	<b>Part No.</b>	550262	<b>Ref. No.</b> —
	flat gasket copper ED ø 20mm ID ø 14mm thickness 2mm		

			
<b>Part No.</b>	418325	<b>Ref. No.</b>	574139
<b>description</b>	heating element 2400W 230V heating circuits 1 L 530mm W 665mm L1 30mm L2 500mm W1 605mm W2 60mm mounting distance 52mm thread M14x1.5 tube ø 8.5mm connection M4 mounting pos. upper dry heating element 2 hole fixing		
<b>For models:</b>	0522102-04, 0722101-06, 1422101-04, 1422101-05, 1422101-06, 1422301-01, 2023114-00, 2023118-00, 2023119-00, 2023203-07, 2023205-07, 2023207-03, 2023207-04, 2023207-05, 2023406-00, 2023503-10, 2023503-11, 2023503-12, 2023503-13, 2023503A10, 2023503A11, 2023503A12, 2023503A13, 2063403-08, 2063403-09, 2063403-10, 2063406-08, 2063406-09, 2063406-10, 2063415-05, 2063418-05, 2063502-08, 2063502-09, 2063502-10, 2063507-08, 2063507-09, 3023205-00, 3023406-00		
<b>accessories for</b>	418325		
	<b>Part No.</b>	510417	<b>Ref. No.</b> —
	flat gasket fibre ED ø 20mm ID ø 14mm thickness 2mm Qty 1 pcs		

<b>accessories for</b>	418325		
	<b>Part No.</b>	520228	<b>Ref. No.</b> —
	tooth lock washer ID ø 15.3mm ED ø 24mm steel Qty 1 pcs for thread M14		
	<b>Part No.</b>	520230	<b>Ref. No.</b> —
	nut thread M14x1.5 H 5mm WS 19 zinc-coated steel Qty 1 pcs		
	<b>Part No.</b>	521101	<b>Ref. No.</b> 113000
	nut thread M14x1.5 H 5mm WS 19 SS Qty 1 pcs		
	<b>Part No.</b>	550262	<b>Ref. No.</b> —
	flat gasket copper ED ø 20mm ID ø 14mm thickness 2mm		

			
<b>Part No.</b>	416447	<b>Ref. No.</b>	574088
<b>description</b>	heating element 2450W 230V heating circuits 1 L 495mm W 510mm L1 65mm L2 430mm W1 440mm W2 70mm mounting distance 62mm thread M14x1.5 tube ø 8.5mm connection M4 mounting pos. upper dry heating element 2 hole fixing		
<b>For models:</b>	0522101-01, 0522101-02, 0522101-03, 1323208-00, 1323208-01, 1323208-02, 1323208-03, 1323210-00, 1323210-01, 1323210-02, 1363403-00, 1363403-01, 1363403-02, 1422102-01, 1422102-02, 1422102-03, 2123203-01, 2123203-02, 2123203-03, 2123203-04, 2123203-05, 2123203-06, 2123203-07, 2123203A01, 2123203A02, 2123203A03, 2123203A04, 2123204-01, 2123204-02, 2123204-03, 2123204-04, 2123204-05, 2123204-06, 2123204-07, 2123204A01, 2123204A02, 2123204A03, 2123204A04, 2123208-00, 2123208-01, 2123208A00, 2123208A01, 2123503-00, 2123503-01, 2123503-02, 2123503-03, 2123503-04, 2123503-05, 2123503A00, 2123503A01... (Other models you can see in the webshop)		
<b>accessories for</b>	416447		
	<b>Part No.</b>	510417	<b>Ref. No.</b> —
	flat gasket fibre ED ø 20mm ID ø 14mm thickness 2mm Qty 1 pcs		
	<b>Part No.</b>	520228	<b>Ref. No.</b> —
	tooth lock washer ID ø 15.3mm ED ø 24mm steel Qty 1 pcs for thread M14		
	<b>Part No.</b>	521101	<b>Ref. No.</b> 113000
	nut thread M14x1.5 H 5mm WS 19 SS Qty 1 pcs		
	<b>Part No.</b>	550262	<b>Ref. No.</b> —
	flat gasket copper ED ø 20mm ID ø 14mm thickness 2mm		



<b>Part No.</b>	415904	<b>Ref. No.</b>	574086
<b>description</b>	heating element 2900W 230V heating circuits 1 L 490mm W 680mm L1 70mm L2 420mm W1 630mm W2 50mm mounting distance 42mm thread M14x1.5 tube ø 8.5mm connection M4 mounting pos. upper 2 hole fixing		
<b>For models:</b>	0522102-01, 0522102-02, 0522102-03, 1422101-01, 1422101-02, 1422101-03, 2023203-01, 2023203-02, 2023203-03, 2023203-04, 2023203-05, 2023203-06, 2023203A01, 2023203A02, 2023203A03, 2023205-01, 2023205-02, 2023205-03, 2023205-04, 2023205-05, 2023205-06, 2023205A01, 2023205A02, 2023205A03, 2023207-00, 2023207-01, 2023207-02, 2023503-02, 2023503-03, 2023503-04, 2023503-05, 2023503-06, 2023503-07, 2023503-08, 2023503-09, 2023503A02, 2023503A03, 2023503A04, 2023503A05, 2023503A06, 2023503A07, 2023503A08, 2023503A09, 2063403-02, 2063403-03, 2063403-04, 2063403-05, 2063403-06, 2063403-07, 2063406-02... (Other models you can see in the webshop)		
<b>accessories for</b>	415904		
	<b>Part No.</b>	510417	<b>Ref. No.</b> —
	flat gasket fibre ED ø 20mm ID ø 14mm thickness 2mm Qty 1 pcs		
	<b>Part No.</b>	520228	<b>Ref. No.</b> —
	tooth lock washer ID ø 15.3mm ED ø 24mm steel Qty 1 pcs for thread M14		
	<b>Part No.</b>	521101	<b>Ref. No.</b> 113000
	nut thread M14x1.5 H 5mm WS 19 SS Qty 1 pcs		
	<b>Part No.</b>	550262	<b>Ref. No.</b> —
	flat gasket copper ED ø 20mm ID ø 14mm thickness 2mm		

<b>Part No.</b>	415781	<b>Ref. No.</b>	574064
<b>description</b>	heating element 900W 380V heating circuits 1 L 497mm W 313mm L1 80mm L2 417mm W1 180mm W2 133mm mounting distance 126mm thread M14x1.5 tube ø 8.5mm connection M4 mounting pos. upper outer dry heating element 2 hole fixing		
<b>accessories for</b>	415781		
	<b>Part No.</b>	510417	<b>Ref. No.</b> —
	flat gasket fibre ED ø 20mm ID ø 14mm thickness 2mm Qty 1 pcs		
	<b>Part No.</b>	520228	<b>Ref. No.</b> —
	tooth lock washer ID ø 15.3mm ED ø 24mm steel Qty 1 pcs for thread M14		
	<b>Part No.</b>	520230	<b>Ref. No.</b> —
	nut thread M14x1.5 H 5mm WS 19 zinc-coated steel Qty 1 pcs		
	<b>Part No.</b>	521101	<b>Ref. No.</b> 113000
	nut thread M14x1.5 H 5mm WS 19 SS Qty 1 pcs		

<b>accessories for</b>	415781		
	<b>Part No.</b>	550262	<b>Ref. No.</b> —
	flat gasket copper ED ø 20mm ID ø 14mm thickness 2mm		





<b>Part No.</b>	415782	<b>Ref. No.</b>	574065
<b>description</b>	heating element 950W 380V L 452mm W 185mm L1 135mm L2 317mm W1 122mm W2 63mm mounting distance 56mm thread M14x1.5 tube ø 8.5mm connection M4 mounting pos. upper inner dry heating element oven 2 hole fixing		
<b>accessories for</b>	415782		
	<b>Part No.</b>	510417	<b>Ref. No.</b> —
	flat gasket fibre ED ø 20mm ID ø 14mm thickness 2mm Qty 1 pcs		
	<b>Part No.</b>	520228	<b>Ref. No.</b> —
	tooth lock washer ID ø 15.3mm ED ø 24mm steel Qty 1 pcs for thread M14		
	<b>Part No.</b>	520230	<b>Ref. No.</b> —
	nut thread M14x1.5 H 5mm WS 19 zinc-coated steel Qty 1 pcs		
	<b>Part No.</b>	521101	<b>Ref. No.</b> 113000
	nut thread M14x1.5 H 5mm WS 19 SS Qty 1 pcs		
	<b>Part No.</b>	550262	<b>Ref. No.</b> —
	flat gasket copper ED ø 20mm ID ø 14mm thickness 2mm		


heating elements for bain maries

<b>Part No.</b>	415449	<b>Ref. No.</b>	573007
<b>description</b>	heating element 1000W 220V heating circuits 1 L 290mm W 177mm connection M4 tube ø 8.5mm 2 hole fixing thread M14x1.5 immersion heater H 18mm mounting distance 162mm		
<b>For models:</b>	1820501-00, 18208011-0		
<b>accessories for</b>	415449		
	<b>Part No.</b>	510417	<b>Ref. No.</b> —
	flat gasket fibre ED ø 20mm ID ø 14mm thickness 2mm Qty 1 pcs		
	<b>Part No.</b>	520228	<b>Ref. No.</b> —
	tooth lock washer ID ø 15.3mm ED ø 24mm steel Qty 1 pcs for thread M14		
	<b>Part No.</b>	520230	<b>Ref. No.</b> —
	nut thread M14x1.5 H 5mm WS 19 zinc-coated steel Qty 1 pcs		
	<b>Part No.</b>	521101	<b>Ref. No.</b> 113000
	nut thread M14x1.5 H 5mm WS 19 SS Qty 1 pcs		
	<b>Part No.</b>	521103	<b>Ref. No.</b> —
	nut thread M4 H 3mm WS 7 brass Qty 20 pcs		


Table continues overleaf










<b>accessories for</b> 415449			
	<b>Part No.</b> 521104	<b>Ref. No.</b>	—
washer ID ø 4.3mm ED ø 8mm thickness 0.5mm brass Qty 20 pcs for thread M4			
	<b>Part No.</b> 550262	<b>Ref. No.</b>	—
flat gasket copper ED ø 20mm ID ø 14mm thickness 2mm			
	<b>Part No.</b> 560111	<b>Ref. No.</b> 120017	
plain washer ID ø 4.3mm ED ø 9mm thickness 0.8mm SS Qty 20 pcs DIN 125A for thread M4			
	<b>Part No.</b> 560131	<b>Ref. No.</b>	—
hexagonal nut thread M4 H 3.2mm WS 7 SS DIN/ISO DIN 934 / ISO 4032/8673 Qty 20 pcs			

			
<b>Part No.</b>	418302	<b>Ref. No.</b>	573015
<b>description</b>	heating element 1000W 230V heating circuits 1 L 412mm W 100mm flange length 122mm flange width 20mm hole distance 112mm connection length 82mm connection male faston 6.3mm tube ø 8.5mm rectangular flange hole ø 5.4mm dry heating element bain marie		
<b>For models:</b>	1220501-01, 1220802-00, 1220802-01, 1320501-00, 1320501A00, 1320802-00, 1320802A00, 1420501-02, 1420504-02, 1420801-01, 1420803-01, 2020505-02, 2020505-03, 2120501-03, 2120501-04, 2120510-00, 3020505-02		










			
<b>Part No.</b>	415816	<b>Ref. No.</b>	573002
<b>description</b>	heating element 1000W 230V heating circuits 1 L 445mm W 135mm connection M4 tube ø 8.5mm 2 hole fixing thread M14x1.5 immersion heater mounting distance 126mm		
<b>spare parts for</b>	415816		
	<b>Part No.</b> 510417	<b>Ref. No.</b>	—
flat gasket fibre ED ø 20mm ID ø 14mm thickness 2mm Qty 1 pcs			
<b>accessories for</b>	415816		
	<b>Part No.</b> 520228	<b>Ref. No.</b>	—
tooth lock washer ID ø 15.3mm ED ø 24mm steel Qty 1 pcs for thread M14			
	<b>Part No.</b> 520230	<b>Ref. No.</b>	—
nut thread M14x1.5 H 5mm WS 19 zinc-coated steel Qty 1 pcs			
	<b>Part No.</b> 521101	<b>Ref. No.</b> 113000	
nut thread M14x1.5 H 5mm WS 19 SS Qty 1 pcs			
	<b>Part No.</b> 521103	<b>Ref. No.</b>	—
nut thread M4 H 3mm WS 7 brass Qty 20 pcs			
	<b>Part No.</b> 521104	<b>Ref. No.</b>	—
washer ID ø 4.3mm ED ø 8mm thickness 0.5mm brass Qty 20 pcs for thread M4			
	<b>Part No.</b> 550262	<b>Ref. No.</b>	—
flat gasket copper ED ø 20mm ID ø 14mm thickness 2mm			
	<b>Part No.</b> 560111	<b>Ref. No.</b> 120017	
plain washer ID ø 4.3mm ED ø 9mm thickness 0.8mm SS Qty 20 pcs DIN 125A for thread M4			
	<b>Part No.</b> 560131	<b>Ref. No.</b>	—
hexagonal nut thread M4 H 3.2mm WS 7 SS DIN/ISO DIN 934 / ISO 4032/8673 Qty 20 pcs			




			
<b>Part No.</b>	420420	<b>Ref. No.</b>	574145
<b>description</b>	heating element 1200W 230V heating circuits 1 L 545mm W 40mm connection F6.3 tube ø 8.5mm		
<b>For models:</b>	0021130A00, 0021130A01, 1022512-00, 1022603-00, 1220402-00, 1220402-01, 1222603-00, 1320402-00, 1320402-01, 1322603-00, 1322604-00, 1420402-00, 1420402-01, 1420403-01, 1420403-02, 1420403B02, 1420405-00, 1422701-00, 1422702-00, 1520402-00, 1520402-01, 1520403-00, 1520403-01, 1522603-00, 1522603-01, 2020402-00, 2020402-01, 2020403-00, 2020403-01, 2021409-00, 2021409-01, 2021409-02, 2021409B00, 2021409B01, 2021409B02, 2021419-00, 2021419B00, 2021440-00, 2021440-03, 2021440-04, 2021440-05, 2021440A02, 2021440A03, 2021440A04, 2021440A05, 2021440B03, 2021440B04, 2021440B05, 2021440C02, 2021440C03... (Other models you can see in the webshop)		


			
<b>Part No.</b>	418303	<b>Ref. No.</b>	574107
<b>description</b>	heating element 1200W 230V L 510mm W 45mm H connection male faston 6.3mm dry heating element heating circuits 1 tube ø 8.5mm connection distance 35mm		
<b>For models:</b>	0021135A00, 1220504-01, 1222601-00, 1320504-01, 1320504-02, 1322601-00, 1420509-01, 1422601-00, 1422602-00, 2020506-01, 2021401-04, 2021401-05, 2021401-06, 2021401-07, 2021401-08, 2021401-09, 2021401A03, 2021401A04, 2021401A06, 2021401A07, 2021401A08, 2021401A09, 2021401B03, 2021401B04, 2021401B06, 2021401B07, 2021401B08, 2021401B09, 2021401C03, 2021401C04, 2021401C06, 2021401C07, 2021401C08, 2021401C09, 2021402-04, 2021402-05, 2021402-06, 2021402-07, 2021402-08, 2021402A03, 2021402A04, 2021402A06, 2021402A07, 2021402A08, 2021402B03, 2021402B04, 2021402B06, 2021402B07, 2021402B08, 2021402C03... (Other models you can see in the webshop)		

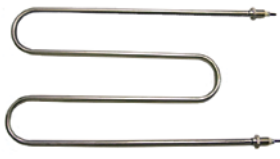








			
<b>Part No.</b>	415420	<b>Ref. No.</b>	573000
<b>description</b>	heating element 1500W 220V heating circuits 1 L 443mm W 114mm connection M4 tube ø 8.5mm 2 hole fixing thread M14x1.5 H 22mm mounting distance 105mm		
<b>accessories for</b>	415420		
	<b>Part No.</b> 510417	<b>Ref. No.</b>	—
flat gasket fibre ED ø 20mm ID ø 14mm thickness 2mm Qty 1 pcs			
	<b>Part No.</b> 520228	<b>Ref. No.</b>	—
tooth lock washer ID ø 15.3mm ED ø 24mm steel Qty 1 pcs for thread M14			
	<b>Part No.</b> 520230	<b>Ref. No.</b>	—
nut thread M14x1.5 H 5mm WS 19 zinc-coated steel Qty 1 pcs			
	<b>Part No.</b> 521101	<b>Ref. No.</b> 113000	
nut thread M14x1.5 H 5mm WS 19 SS Qty 1 pcs			
	<b>Part No.</b> 550262	<b>Ref. No.</b>	—
flat gasket copper ED ø 20mm ID ø 14mm thickness 2mm			



 <p>1</p>			
<b>Part No.</b>	415421	<b>Ref. No.</b>	573004
<b>description</b>	heating element 1500W 220V heating circuits 1 L 445mm W 135mm connection M4 tube ø 8.5mm 2 hole fixing thread M14x1.5 immersion heater L1 20mm L2 50mm L3 380mm W1 20mm W2 117mm mounting distance 129mm		
<b>For models:</b>	0220501-00, 0220502-00, 0220503-00, 1420501-00, 1420502-00, 1420504-00, 1420505-00, 2020501-00, 2020501-01, 20205011-0, 2020502-00, 2020505-00, 2120501-00, 2120501-01, 2120502-00, 2120502-01, 3020501-00, 3020502-00, 3020505-00		
<b>spare parts for</b>	415421		
	<b>Part No.</b>	510407	<b>Ref. No.</b> —
	flat gasket fibre ED ø 78mm ID ø 60mm thickness 2mm for heating element for thread 2" Qty 1 pcs		
<b>accessories for</b>	415421		
	<b>Part No.</b>	510417	<b>Ref. No.</b> —
	flat gasket fibre ED ø 20mm ID ø 14mm thickness 2mm Qty 1 pcs		
	<b>Part No.</b>	520228	<b>Ref. No.</b> —
	tooth lock washer ID ø 15.3mm ED ø 24mm steel Qty 1 pcs for thread M14		
	<b>Part No.</b>	520230	<b>Ref. No.</b> —
	nut thread M14x1.5 H 5mm WS 19 zinc-coated steel Qty 1 pcs		
	<b>Part No.</b>	521101	<b>Ref. No.</b> 113000
	nut thread M14x1.5 H 5mm WS 19 SS Qty 1 pcs		
	<b>Part No.</b>	521103	<b>Ref. No.</b> —
	nut thread M4 H 3mm WS 7 brass Qty 20 pcs		
	<b>Part No.</b>	521104	<b>Ref. No.</b> —
	washer ID ø 4.3mm ED ø 8mm thickness 0.5mm brass Qty 20 pcs for thread M4		
	<b>Part No.</b>	550262	<b>Ref. No.</b> —
	flat gasket copper ED ø 20mm ID ø 14mm thickness 2mm		
	<b>Part No.</b>	560111	<b>Ref. No.</b> 120017
	plain washer ID ø 4.3mm ED ø 9mm thickness 0.8mm SS Qty 20 pcs DIN 125A for thread M4		
	<b>Part No.</b>	560131	<b>Ref. No.</b> —
	hexagonal nut thread M4 H 3.2mm WS 7 SS DIN/ISO DIN 934 / ISO 4032/8673 Qty 20 pcs		

 <p>1</p>			
<b>Part No.</b>	419055	<b>Ref. No.</b>	573020
<b>description</b>	heating element 1750W 400V heating circuits 1 L 490mm W 88.5mm connection M4 tube ø 8.5mm dry heating element W1 10mm W2 75mm 2 hole fixing thread M14x1.5 H 72mm mounting distance 55mm		
<b>For models:</b>	1221501-00, 1221501-01, 1221501-02, 1321501-00, 1321501-01, 1321501-02, 1321501-03, 1421501-01, 1421501-02, 1421503-01, 1421503-02, 1521501-00, 2121501-01, 2121501-02		
<b>accessories for</b>	419055		
	<b>Part No.</b>	520230	<b>Ref. No.</b> —
	nut thread M14x1.5 H 5mm WS 19 zinc-coated steel Qty 1 pcs		
	<b>Part No.</b>	521103	<b>Ref. No.</b> —
	nut thread M4 H 3mm WS 7 brass Qty 20 pcs		

<b>accessories for</b>	419055		
	<b>Part No.</b>	529480	<b>Ref. No.</b> —
	flat gasket copper ED ø 18mm ID ø 14mm thickness 1.5mm		

 <p>1</p>			
<b>Part No.</b>	415419	<b>Ref. No.</b>	573006
<b>description</b>	heating element 2000W 230V heating circuits 1 L 405mm W 218.5mm connection M4 tube ø 8.5mm 2 hole fixing thread M14x1.5 immersion heater mounting distance 210mm		
<b>For models:</b>	20205033-0, 2020504-00		
<b>spare parts for</b>	415419		
	<b>Part No.</b>	510417	<b>Ref. No.</b> —
	flat gasket fibre ED ø 20mm ID ø 14mm thickness 2mm Qty 1 pcs		
<b>accessories for</b>	415419		
	<b>Part No.</b>	520228	<b>Ref. No.</b> —
	tooth lock washer ID ø 15.3mm ED ø 24mm steel Qty 1 pcs for thread M14		
	<b>Part No.</b>	521101	<b>Ref. No.</b> 113000
	nut thread M14x1.5 H 5mm WS 19 SS Qty 1 pcs		
	<b>Part No.</b>	521103	<b>Ref. No.</b> —
	nut thread M4 H 3mm WS 7 brass Qty 20 pcs		
	<b>Part No.</b>	521104	<b>Ref. No.</b> —
	washer ID ø 4.3mm ED ø 8mm thickness 0.5mm brass Qty 20 pcs for thread M4		
	<b>Part No.</b>	550262	<b>Ref. No.</b> —
	flat gasket copper ED ø 20mm ID ø 14mm thickness 2mm		
	<b>Part No.</b>	560111	<b>Ref. No.</b> 120017
	plain washer ID ø 4.3mm ED ø 9mm thickness 0.8mm SS Qty 20 pcs DIN 125A for thread M4		
	<b>Part No.</b>	560131	<b>Ref. No.</b> —
	hexagonal nut thread M4 H 3.2mm WS 7 SS DIN/ISO DIN 934 / ISO 4032/8673 Qty 20 pcs		









 <p>1</p>			
<b>Part No.</b>	415821	<b>Ref. No.</b>	573012
<b>description</b>	heating element 3000W 230V heating circuits 1 L 420mm W 125mm connection M4 tube ø 8.5mm 2 hole fixing thread M14x1.5 immersion heater H 20mm mounting distance 117mm		
<b>spare parts for</b>	415821		
	<b>Part No.</b>	510417	<b>Ref. No.</b> —
	flat gasket fibre ED ø 20mm ID ø 14mm thickness 2mm Qty 1 pcs		
<b>accessories for</b>	415821		
	<b>Part No.</b>	520228	<b>Ref. No.</b> —
	tooth lock washer ID ø 15.3mm ED ø 24mm steel Qty 1 pcs for thread M14		

Table continues overleaf









accessories for	415821		
	Part No.	520230	Ref. No. —
	nut thread M14x1.5 H 5mm WS 19 zinc-coated steel Qty 1 pcs		
	Part No.	521101	Ref. No. 113000
	nut thread M14x1.5 H 5mm WS 19 SS Qty 1 pcs		
	Part No.	521103	Ref. No. —
	nut thread M4 H 3mm WS 7 brass Qty 20 pcs		
	Part No.	521104	Ref. No. —
	washer ID ø 4.3mm ED ø 8mm thickness 0.5mm brass Qty 20 pcs for thread M4		
	Part No.	550262	Ref. No. —
	flat gasket copper ED ø 20mm ID ø 14mm thickness 2mm		
	Part No.	560111	Ref. No. 120017
	plain washer ID ø 4.3mm ED ø 9mm thickness 0.8mm SS Qty 20 pcs DIN 125A for thread M4		
	Part No.	560131	Ref. No. —
	hexagonal nut thread M4 H 3.2mm WS 7 SS DIN/ISO DIN 934 / ISO 4032/8673 Qty 20 pcs		

	1		
Part No.	415780	Ref. No.	573096
description	heating element 3000W 230V heating circuits 1 L 465mm W 140mm connection M4 tube ø 8.5mm 2 hole fixing thread M14x1.5 immersion heater L1 25mm L2 40mm L3 400mm W1 25mm W2 105mm mounting distance 125mm		
For models:	0220802-00, 1420801-00, 1420803-00		
spare parts for	415780		
	Part No.	510417	Ref. No. —
	flat gasket fibre ED ø 20mm ID ø 14mm thickness 2mm Qty 1 pcs		
accessories for	415780		
	Part No.	520228	Ref. No. —
	tooth lock washer ID ø 15.3mm ED ø 24mm steel Qty 1 pcs for thread M14		
	Part No.	520230	Ref. No. —
	nut thread M14x1.5 H 5mm WS 19 zinc-coated steel Qty 1 pcs		
	Part No.	521101	Ref. No. 113000
	nut thread M14x1.5 H 5mm WS 19 SS Qty 1 pcs		
	Part No.	550262	Ref. No. —
	flat gasket copper ED ø 20mm ID ø 14mm thickness 2mm		


	1		
Part No.	418314	Ref. No.	573011
description	heating element 950W 230V heating circuits 1 L 390mm W 36mm connection male faston 6.3mm tube ø 8.5mm dry heating element		
For models:	1220504-01, 1222601-00, 1320504-01, 1320504-02, 1322601-00, 1420509-01, 1422601-00, 1422602-00, 2020506-01, 2022601-00, 2022601-01, 2120504-01, 2122601-00, 2122601-01, 2122602-00		






## heating elements for frying pans

	1		
Part No.	418279	Ref. No.	574113
description	heating element 1200W 230V L 502mm W 50mm connection male faston 6.3mm tube ø 8.5mm dry heating element H 58mm		
For models:	0221107-00, 0221107A00, 0221108-00, 0221109-00, 0221109A00, 0221110-00, 1121117-00, 1121117-01, 1121117A00, 1121118-00, 1121118-01, 1121119-00, 1121119A00, 1121120-00, 1121121-00, 1121121A00, 1121135A01, 1221103-00, 1221103-01, 1221103-02, 1221103-04, 1221103A00, 1221103A01, 1221103A02, 1221103B00, 1221103B01, 1221103B02, 1221103B04, 1221103J00, 1221103J01, 1221104-00, 1221104-01, 1221104A00, 1221104A01, 1221104B00, 1221104B01, 1221104J00, 1221104J01, 1221105-00, 1221105-01, 1221105-02, 1221105A00, 1221105A01, 1221105A02, 1221105B00, 1221105B01, 1221105B02, 1221106-00, 1221106-01, 1221106A00... (Other models you can see in the webshop)		



	1		
Part No.	415767	Ref. No.	573054 573054/113000/121216
description	heating element 1500W 230V heating circuits 1 L 425mm W 250mm H 58mm W1 50mm W2 150mm L1 60mm L2 365mm thread M14x1.5 mounting distance 142mm windings 3 tube ø 8.5mm connection M4 dry heating element 2 hole fixing for stockpot		
accessories for	415767		
	Part No.	510417	Ref. No. —
	flat gasket fibre ED ø 20mm ID ø 14mm thickness 2mm Qty 1 pcs		
	Part No.	520228	Ref. No. —
	tooth lock washer ID ø 15.3mm ED ø 24mm steel Qty 1 pcs for thread M14		
	Part No.	520230	Ref. No. —
	nut thread M14x1.5 H 5mm WS 19 zinc-coated steel Qty 1 pcs		
	Part No.	521101	Ref. No. 113000
	nut thread M14x1.5 H 5mm WS 19 SS Qty 1 pcs		
	Part No.	521103	Ref. No. —
	nut thread M4 H 3mm WS 7 brass Qty 20 pcs		
	Part No.	521104	Ref. No. —
	washer ID ø 4.3mm ED ø 8mm thickness 0.5mm brass Qty 20 pcs for thread M4		
	Part No.	550262	Ref. No. —
	flat gasket copper ED ø 20mm ID ø 14mm thickness 2mm		
	Part No.	560111	Ref. No. 120017
	plain washer ID ø 4.3mm ED ø 9mm thickness 0.8mm SS Qty 20 pcs DIN 125A for thread M4		
	Part No.	560131	Ref. No. —
	hexagonal nut thread M4 H 3.2mm WS 7 SS DIN/ISO DIN 934 / ISO 4032/8673 Qty 20 pcs		



<b>Part No.</b>	415768	<b>Ref. No.</b>	573055
<b>description</b>	heating element 2500W 230V L 425mm W 220mm connection M4 tube ø 8.5mm 2 hole fixing thread M14x1.5 dry heating element for stockpot L1 65mm L2 360mm W1 43mm W2 134mm H 60mm windings 4 mounting distance 126mm		
<b>For models:</b>	0221202-00, 1421201-00, 1421203-00		
<b>accessories for</b>	415768		
	<b>Part No.</b>	510417	<b>Ref. No.</b> —
	flat gasket fibre ED ø 20mm ID ø 14mm thickness 2mm Qty 1 pcs		
	<b>Part No.</b>	520228	<b>Ref. No.</b> —
	tooth lock washer ID ø 15.3mm ED ø 24mm steel Qty 1 pcs for thread M14		
	<b>Part No.</b>	520230	<b>Ref. No.</b> —
	nut thread M14x1.5 H 5mm WS 19 zinc-coated steel Qty 1 pcs		
	<b>Part No.</b>	521101	<b>Ref. No.</b> 113000
	nut thread M14x1.5 H 5mm WS 19 SS Qty 1 pcs		
	<b>Part No.</b>	550262	<b>Ref. No.</b> —
	flat gasket copper ED ø 20mm ID ø 14mm thickness 2mm		



<b>Part No.</b>	418316	<b>Ref. No.</b>	574104
<b>description</b>	heating element 1500W 230V heating circuits 1 L 455mm W 212mm connection M4 tube ø 8.5mm 2 hole fixing thread M14x1.5 dry heating element chip scuttle L1 40mm L2 35mm L3 380mm W1 32mm W2 147mm mounting distance 138mm		
<b>For models:</b>	0221001H00		
<b>accessories for</b>	418316		
	<b>Part No.</b>	510417	<b>Ref. No.</b> —
	flat gasket fibre ED ø 20mm ID ø 14mm thickness 2mm Qty 1 pcs		
	<b>Part No.</b>	520228	<b>Ref. No.</b> —
	tooth lock washer ID ø 15.3mm ED ø 24mm steel Qty 1 pcs for thread M14		
	<b>Part No.</b>	520230	<b>Ref. No.</b> —
	nut thread M14x1.5 H 5mm WS 19 zinc-coated steel Qty 1 pcs		
	<b>Part No.</b>	521101	<b>Ref. No.</b> 113000
	nut thread M14x1.5 H 5mm WS 19 SS Qty 1 pcs		
	<b>Part No.</b>	550262	<b>Ref. No.</b> —
	flat gasket copper ED ø 20mm ID ø 14mm thickness 2mm		

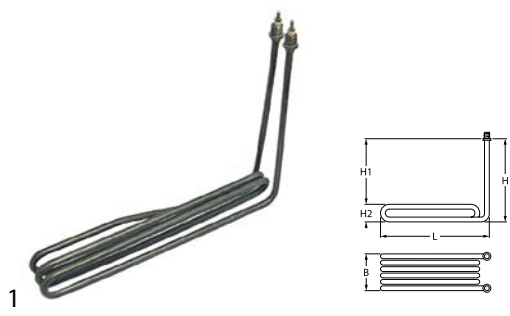
### heating elements for chip scuttles



<b>Part No.</b>	418315	<b>Ref. No.</b>	574054
<b>description</b>	heating element 1000W 230V heating circuits 1 L 385mm W 68mm connection M4 tube ø 8.5mm 2 hole fixing thread M14x1.5 immersion heater chip scuttle mounting distance 60mm		
<b>accessories for</b>	418315		
	<b>Part No.</b>	510417	<b>Ref. No.</b> —
	flat gasket fibre ED ø 20mm ID ø 14mm thickness 2mm Qty 1 pcs		
	<b>Part No.</b>	520228	<b>Ref. No.</b> —
	tooth lock washer ID ø 15.3mm ED ø 24mm steel Qty 1 pcs for thread M14		
	<b>Part No.</b>	520230	<b>Ref. No.</b> —
	nut thread M14x1.5 H 5mm WS 19 zinc-coated steel Qty 1 pcs		
	<b>Part No.</b>	521101	<b>Ref. No.</b> 113000
	nut thread M14x1.5 H 5mm WS 19 SS Qty 1 pcs		
	<b>Part No.</b>	550262	<b>Ref. No.</b> —
	flat gasket copper ED ø 20mm ID ø 14mm thickness 2mm		

### heating elements for fryers

#### 2 hole fixing




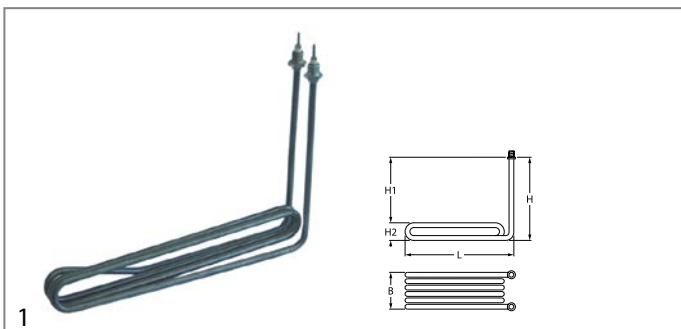
<b>Part No.</b>	415423	<b>Ref. No.</b>	572118
<b>description</b>	heating element 2000W 230V heating circuits 1 L 320mm W 40mm H 215mm H1 175mm H2 40mm thread M14x1.5 tube ø 8.5mm mounting distance 30mm windings 3 2 hole fixing connection M4 connection length 20mm immersion heater SS		
<b>For models:</b>	0220301-00, 0220301D00, 0220302-00, 0220302A00, 0220302A01, 0220302A02, 0220302A03, 0220302D00, 0220302F00, 0220304-00, 0220305-00, 0720325-03, 0720325-04, 0720332P00, 0720332R00, 1220301-00, 1220301-01, 1220301-02, 1220301-03, 1220301-04, 1220301D00, 1220301D01, 1220301J00, 1220301J01, 1220301J02, 1220301J03, 1220302-00, 1220302-01, 1220302D00, 1220303-00, 1220303-01, 1220303-02, 1220303-03, 1220303-04, 1220303-05, 1220303A00, 1220303A01, 1220303A02, 1220303A03, 1220303D00, 1220303D01, 1220303D02, 1220303F01, 1220303F02, 1220303F03, 1220303I00, 1220303I01, 1220303I02, 1220303J01, 1220303J02... (Other models you can see in the webshop)		
<b>spare parts for</b>	415423		
	<b>Part No.</b>	510417	<b>Ref. No.</b> —
	flat gasket fibre ED ø 20mm ID ø 14mm thickness 2mm Qty 1 pcs		



Table continues overleaf







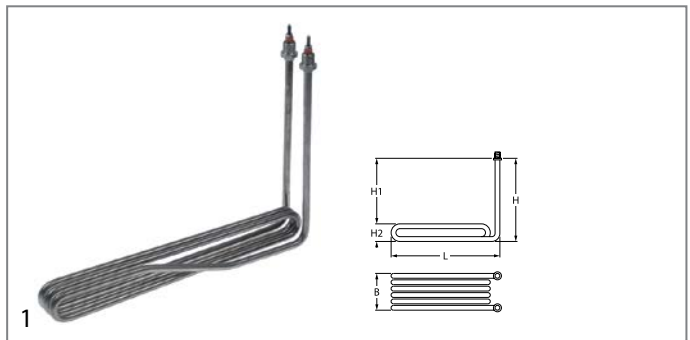




accessories for		415423		
	Part No.	520228	Ref. No.	—
	tooth lock washer ID $\varnothing$ 15.3mm ED $\varnothing$ 24mm steel Qty 1 pcs for thread M14			
	Part No.	520230	Ref. No.	—
	nut thread M14x1.5 H 5mm WS 19 zinc-coated steel Qty 1 pcs			
	Part No.	521101	Ref. No.	113000
	nut thread M14x1.5 H 5mm WS 19 SS Qty 1 pcs			
	Part No.	521103	Ref. No.	—
	nut thread M4 H 3mm WS 7 brass Qty 20 pcs			
	Part No.	521104	Ref. No.	—
	washer ID $\varnothing$ 4.3mm ED $\varnothing$ 8mm thickness 0.5mm brass Qty 20 pcs for thread M4			
	Part No.	550262	Ref. No.	—
	flat gasket copper ED $\varnothing$ 20mm ID $\varnothing$ 14mm thickness 2mm			
	Part No.	560111	Ref. No.	120017
	plain washer ID $\varnothing$ 4.3mm ED $\varnothing$ 9mm thickness 0.8mm SS Qty 20 pcs DIN 125A for thread M4			
	Part No.	560131	Ref. No.	—
	hexagonal nut thread M4 H 3.2mm WS 7 SS DIN/ISO DIN 934 / ISO 4032/8673 Qty 20 pcs			



Part No.	415728	Ref. No.	572124 572124 (old version)	
<b>description</b>	heating element 3300W 230V heating circuits 1 L 315mm W 33mm H 216mm H1 170mm H2 46mm thread M14x1.5 tube $\varnothing$ 8.5mm mounting distance 30mm windings 3 2 hole fixing connection M4 connection length 22mm immersion heater			
<b>For models:</b>	0220301B00, 0220301B01, 0220301B02, 0220302A00, 0220302B00, 0220302B01, 0220302B02, 0220302C00, 0220302C01, 0220302C02, 0220302C03, 0220302E00, 0220302E01, 0220302H00, 0220302H01, 0220304-00, 0220305-00, 0720325B03, 0720325B04, 1220301B00, 1220301B01, 1220301B02, 1220301B03, 1220301B04, 1220301E00, 1220301E01, 1220302B00, 1220302B01, 1220302E00, 1220303B00, 1220303B01, 1220303B02, 1220303B03, 1220303B04, 1220303B05, 1220303C00, 1220303C01, 1220303C02, 1220303C03, 1220303E00, 1220303E01, 1220303E02, 1220303H00, 1220303H01, 1220303H02, 1220303H03, 1220303K00, 1220303K01, 1220304B00, 1220304B01... (Other models you can see in the webshop)			
<b>accessories for</b>	415728			
	Part No.	520228	Ref. No.	—
	tooth lock washer ID $\varnothing$ 15.3mm ED $\varnothing$ 24mm steel Qty 1 pcs for thread M14			
	Part No.	520230	Ref. No.	—
	nut thread M14x1.5 H 5mm WS 19 zinc-coated steel Qty 1 pcs			
	Part No.	521101	Ref. No.	113000
	nut thread M14x1.5 H 5mm WS 19 SS Qty 1 pcs			
	Part No.	521103	Ref. No.	—
	nut thread M4 H 3mm WS 7 brass Qty 20 pcs			

accessories for		415728		
	Part No.	521104	Ref. No.	—
	washer ID $\varnothing$ 4.3mm ED $\varnothing$ 8mm thickness 0.5mm brass Qty 20 pcs for thread M4			
	Part No.	550262	Ref. No.	—
	flat gasket copper ED $\varnothing$ 20mm ID $\varnothing$ 14mm thickness 2mm			
	Part No.	560111	Ref. No.	120017
	plain washer ID $\varnothing$ 4.3mm ED $\varnothing$ 9mm thickness 0.8mm SS Qty 20 pcs DIN 125A for thread M4			
	Part No.	560131	Ref. No.	—
	hexagonal nut thread M4 H 3.2mm WS 7 SS DIN/ISO DIN 934 / ISO 4032/8673 Qty 20 pcs			







Part No.	417729	Ref. No.	572124 (new version)	
<b>description</b>	heating element 3300W 230V heating circuits 1 L 315mm W 33mm H 216mm H1 170mm H2 46mm thread M14x1.5 tube $\varnothing$ 8.5mm mounting distance 30mm windings 3 2 hole fixing connection M4 connection length 22mm immersion heater			
<b>accessories for</b>	417729			
	Part No.	520228	Ref. No.	—
	tooth lock washer ID $\varnothing$ 15.3mm ED $\varnothing$ 24mm steel Qty 1 pcs for thread M14			
	Part No.	520230	Ref. No.	—
	nut thread M14x1.5 H 5mm WS 19 zinc-coated steel Qty 1 pcs			
	Part No.	521101	Ref. No.	113000
	nut thread M14x1.5 H 5mm WS 19 SS Qty 1 pcs			
	Part No.	521103	Ref. No.	—
	nut thread M4 H 3mm WS 7 brass Qty 20 pcs			
	Part No.	521104	Ref. No.	—
	washer ID $\varnothing$ 4.3mm ED $\varnothing$ 8mm thickness 0.5mm brass Qty 20 pcs for thread M4			
	Part No.	550262	Ref. No.	—
	flat gasket copper ED $\varnothing$ 20mm ID $\varnothing$ 14mm thickness 2mm			
	Part No.	560111	Ref. No.	120017
	plain washer ID $\varnothing$ 4.3mm ED $\varnothing$ 9mm thickness 0.8mm SS Qty 20 pcs DIN 125A for thread M4			
	Part No.	560131	Ref. No.	—
	hexagonal nut thread M4 H 3.2mm WS 7 SS DIN/ISO DIN 934 / ISO 4032/8673 Qty 20 pcs			





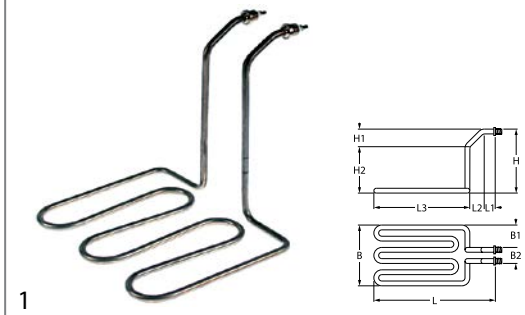








<b>Part No.</b>	415769	<b>Ref. No.</b>	572121 572121+2x113000+2x121216
<b>description</b>	heating element 3300W 230V heating circuits 1 L 320mm W 80mm H 214mm H1 176mm H2 38mm thread M14x1.5 tube ø 8.5mm mounting distance 70mm windings 5 2 hole fixing connection M4 immersion heater		
<b>For models:</b>	0220303-00, 0220303-01, 0220303A00, 0220303A01, 0220303A02, 0220303A03, 0220303D00, 0220303D01, 0220303H00, 0220303H01, 0220306-00, 1220305-00, 1220305-01, 1220305-02, 1220305-03, 1220305-04, 1220305-05, 1220305-06, 1220305-07, 1220305A00, 1220305A01, 1220305A02, 1220305A03, 1220305A04, 1220305A05, 1220305D00, 1220305D01, 1220305D02, 1220305D03, 1220305D04, 1220305F01, 1220305F02, 1220305F03, 1220305F04, 1220305F05, 1220305J01, 1220305J02, 1220306-00, 1220306-01, 1220306A01, 1220306A02, 1220306A03, 1220306A04, 1220306D00, 1220306F00, 1220306F01, 1220306F02, 1220306F03, 1220329-00, 1220329-01... (Other models you can see in the webshop)		
<b>spare parts for</b>	415769		
	<b>Part No.</b>	510417	<b>Ref. No.</b> —
	flat gasket fibre ED ø 20mm ID ø 14mm thickness 2mm Qty 1 pcs		
<b>accessories for</b>	415769		
	<b>Part No.</b>	521103	<b>Ref. No.</b> —
	nut thread M4 H 3mm WS 7 brass Qty 20 pcs		
	<b>Part No.</b>	521104	<b>Ref. No.</b> —
	washer ID ø 4.3mm ED ø 8mm thickness 0.5mm brass Qty 20 pcs for thread M4		
	<b>Part No.</b>	560111	<b>Ref. No.</b> 120017
	plain washer ID ø 4.3mm ED ø 9mm thickness 0.8mm SS Qty 20 pcs DIN 125A for thread M4		
	<b>Part No.</b>	560131	<b>Ref. No.</b> —
	hexagonal nut thread M4 H 3.2mm WS 7 SS DIN/ISO DIN 934 / ISO 4032/8673 Qty 20 pcs		

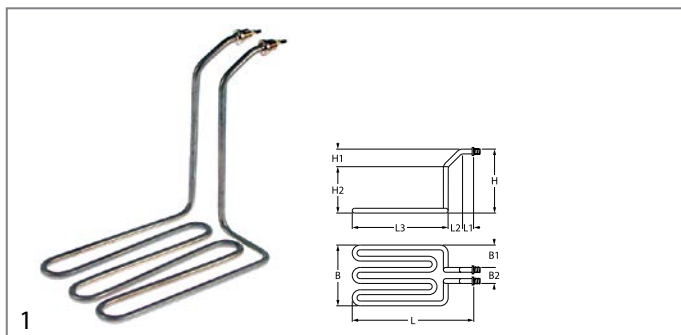
<b>Part No.</b>	415779	<b>Ref. No.</b>	572128 572128+2x113000+2x121216
<b>description</b>	heating element 3300W 230V heating circuits 1 L 323mm W 70mm H 222mm H1 180mm H2 42mm thread M14x1.5 tube ø 10mm mounting distance 50mm windings 4 2 hole fixing connection M4 immersion heater		
<b>For models:</b>	0220303B00, 0220303B01, 0220303C00, 0220303C01, 0220303C02, 0220303E00, 0220303E01, 0220306-00, 1220305B00, 1220305B01, 1220305B02, 1220305B03, 1220305C00, 1220305C01, 1220305C02, 1220305C03, 1220305C04, 1220305E00, 1220305E01, 1220305E02, 1220305E03, 1220305H00, 1220305H01, 1220305H02, 1220305H03, 1220305H04, 1220306C02, 1220306H01, 1320305B00, 1320305B01, 1320305B02, 1320305B03, 1320305C00, 1320305C01, 1320305C02, 1320305C03, 1320305E00, 1320305E01, 1320305E02, 1320305E03, 1320305E04, 1320305H00, 1320305H01, 1320305H02, 1320305H03, 1320305H04, 1320306C02, 1320306H02, 1420303B00, 1420303B02... (Other models you can see in the webshop)		
<b>accessories for</b>	415779		
	<b>Part No.</b>	521101	<b>Ref. No.</b> 113000
	nut thread M14x1.5 H 5mm WS 19 SS Qty 1 pcs		
	<b>Part No.</b>	521103	<b>Ref. No.</b> —
	nut thread M4 H 3mm WS 7 brass Qty 20 pcs		
	<b>Part No.</b>	521104	<b>Ref. No.</b> —
	washer ID ø 4.3mm ED ø 8mm thickness 0.5mm brass Qty 20 pcs for thread M4		
	<b>Part No.</b>	560111	<b>Ref. No.</b> 120017
	plain washer ID ø 4.3mm ED ø 9mm thickness 0.8mm SS Qty 20 pcs DIN 125A for thread M4		
	<b>Part No.</b>	560131	<b>Ref. No.</b> —
	hexagonal nut thread M4 H 3.2mm WS 7 SS DIN/ISO DIN 934 / ISO 4032/8673 Qty 20 pcs		




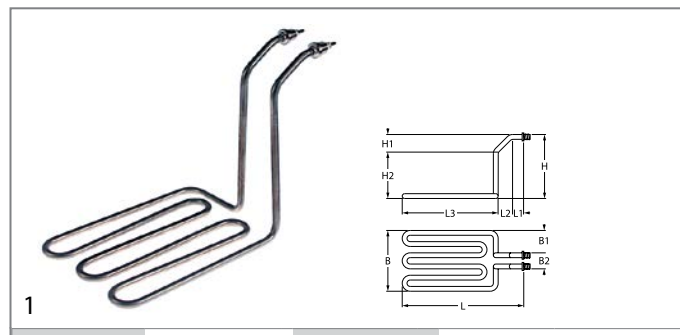
			
<b>Part No.</b>	415815	<b>Ref. No.</b>	572135
<b>description</b>	heating element 3560W 230V heating circuits 1 L 490mm W 35mm H 260mm H1 220mm H2 40mm thread M14x1.5 tube ø 8.5mm mounting distance 25mm windings 3 2 hole fixing connection M5 connection length 20mm immersion heater fryer		
<b>For models:</b>	2020303-00, 2020303-01, 2020303-02, 2020303-03, 2020303-04, 2020303A00, 2020310-00, 2020310-01, 2020310-02, 2020310-03, 2020310A00, 2020310A01, 2020310A02, 2020310A03, 2020311-00, 2020311-01, 2020311-02, 2020311-03, 2020311A00, 2020311A01, 2020311A02, 2020311A03, 2020312A00, 2020312A01, 2020312A02, 2020314-01, 2020314-02, 2020314-03, 2020314A01, 2020314A02, 2020314A03, 2020315-01, 2020315-02, 2020315-03, 2020315A01, 2020315A02, 2020315A03, 2020339A00, 2020339A01, 2020340A00, 2020340A01, 2020341-00, 2020341A00, 2020342-00, 2020342A00, 3020310-00, 3020310-01, 3020310A00, 3020310A01, 3020311-00... (Other models you can see in the webshop)		
<b>accessories for</b>	415815		
	<b>Part No.</b>	528401	<b>Ref. No.</b> —
	flat gasket fibre ED ø 22mm ID ø 16mm thickness 2mm Qty 1 pcs		
	<b>Part No.</b>	560112	<b>Ref. No.</b> 120022
	plain washer ID ø 5.3mm ED ø 10mm thickness 1mm SS Qty 20 pcs DIN 125A for thread M5		
	<b>Part No.</b>	560132	<b>Ref. No.</b> —
	hexagonal nut thread M5 H 4mm WS 8 SS DIN/ISO DIN 934 / ISO 4032/8673 Qty 20 pcs		

			
<b>Part No.</b>	417533	<b>Ref. No.</b>	572121(old)
<b>description</b>	heating element 3300W 230V heating circuits 1 L 320mm W 80mm H 220mm W1 20mm W2 47mm H1 175mm H2 42mm thread M14x1.25 tube ø 10mm 2 hole fixing immersion heater		
<b>accessories for</b>	417533		
	<b>Part No.</b>	521103	<b>Ref. No.</b> —
	nut thread M4 H 3mm WS 7 brass Qty 20 pcs		
	<b>Part No.</b>	521104	<b>Ref. No.</b> —
	washer ID ø 4.3mm ED ø 8mm thickness 0.5mm brass Qty 20 pcs for thread M4		
	<b>Part No.</b>	560111	<b>Ref. No.</b> 120017
	plain washer ID ø 4.3mm ED ø 9mm thickness 0.8mm SS Qty 20 pcs DIN 125A for thread M4		
	<b>Part No.</b>	560131	<b>Ref. No.</b> —
	hexagonal nut thread M4 H 3.2mm WS 7 SS DIN/ISO DIN 934 / ISO 4032/8673 Qty 20 pcs		

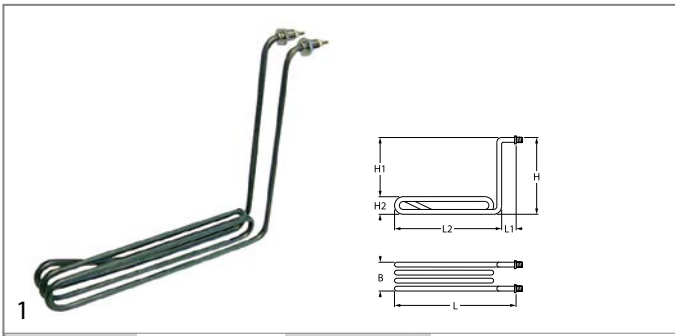
			
<b>Part No.</b>	418366	<b>Ref. No.</b>	572098
<b>description</b>	heating element 2000W 230V heating circuits 1 mounting pos. centre L 260mm W 260mm H 223mm 2 hole fixing connection M4 fryer L1 20mm L2 40mm L3 200mm W1 88mm W2 84mm H1 33mm H2 190mm tube ø 8.5mm thread M14x1.5 mounting distance 75mm connection length 13mm windings 3		
<b>For models:</b>	0520302A00, 0520302A01		
<b>accessories for</b>	418366		
	<b>Part No.</b>	361182	<b>Ref. No.</b> —
	nut thread 1/4" H 5mm nickel-plated brass WS 17 Qty 1 pcs		
	<b>Part No.</b>	510417	<b>Ref. No.</b> —
	flat gasket fibre ED ø 20mm ID ø 14mm thickness 2mm Qty 1 pcs		
	<b>Part No.</b>	520228	<b>Ref. No.</b> —
	tooth lock washer ID ø 15.3mm ED ø 24mm steel Qty 1 pcs for thread M14		
	<b>Part No.</b>	521103	<b>Ref. No.</b> —
	nut thread M4 H 3mm WS 7 brass Qty 20 pcs		
	<b>Part No.</b>	521104	<b>Ref. No.</b> —
	washer ID ø 4.3mm ED ø 8mm thickness 0.5mm brass Qty 20 pcs for thread M4		
	<b>Part No.</b>	550262	<b>Ref. No.</b> —
	flat gasket copper ED ø 20mm ID ø 14mm thickness 2mm		
	<b>Part No.</b>	560111	<b>Ref. No.</b> 120017
	plain washer ID ø 4.3mm ED ø 9mm thickness 0.8mm SS Qty 20 pcs DIN 125A for thread M4		
	<b>Part No.</b>	560131	<b>Ref. No.</b> —
	hexagonal nut thread M4 H 3.2mm WS 7 SS DIN/ISO DIN 934 / ISO 4032/8673 Qty 20 pcs		



<b>Part No.</b>	418368	<b>Ref. No.</b>	572099
<b>description</b>	heating element 2000W 230V heating circuits 1 mounting pos. left L 285mm W 160mm H 210mm 2 hole fixing connection M4 immersion heater L1 15mm L2 45mm L3 225mm W1 95mm W2 65mm H1 35mm H2 175mm tube ø 8.5mm thread M14x1.5 mounting distance 51mm connection length 30mm windings 3		
<b>For models:</b>	0520302A00, 0520302A01		
<b>accessories for</b>	418368		
	<b>Part No.</b>	510417	<b>Ref. No.</b> —
	flat gasket fibre ED ø 20mm ID ø 14mm thickness 2mm Qty 1 pcs		
	<b>Part No.</b>	520228	<b>Ref. No.</b> —
	tooth lock washer ID ø 15.3mm ED ø 24mm steel Qty 1 pcs for thread M14		
	<b>Part No.</b>	520230	<b>Ref. No.</b> —
	nut thread M14x1.5 H 5mm WS 19 zinc-coated steel Qty 1 pcs		
	<b>Part No.</b>	521101	<b>Ref. No.</b> 113000
	nut thread M14x1.5 H 5mm WS 19 SS Qty 1 pcs		
	<b>Part No.</b>	521103	<b>Ref. No.</b> —
	nut thread M4 H 3mm WS 7 brass Qty 20 pcs		
	<b>Part No.</b>	521104	<b>Ref. No.</b> —
	washer ID ø 4.3mm ED ø 8mm thickness 0.5mm brass Qty 20 pcs for thread M4		
	<b>Part No.</b>	550262	<b>Ref. No.</b> —
	flat gasket copper ED ø 20mm ID ø 14mm thickness 2mm		
	<b>Part No.</b>	560111	<b>Ref. No.</b> 120017
	plain washer ID ø 4.3mm ED ø 9mm thickness 0.8mm SS Qty 20 pcs DIN 125A for thread M4		
	<b>Part No.</b>	560131	<b>Ref. No.</b> —
	hexagonal nut thread M4 H 3.2mm WS 7 SS DIN/ISO DIN 934 / ISO 4032/8673 Qty 20 pcs		



<b>Part No.</b>	418367	<b>Ref. No.</b>	572097
<b>description</b>	heating element 2000W 230V heating circuits 1 mounting pos. right L 285mm W 160mm H 210mm 2 hole fixing connection M4 fryer heaters L1 15mm L2 45mm L3 225mm W1 95mm W2 65mm H1 35mm H2 175mm tube ø 8.5mm thread M14x1.5 mounting distance 51mm connection length 30mm windings 3		
<b>For models:</b>	0520302A00, 0520302A01		
<b>accessories for</b>	418367		
	<b>Part No.</b>	510417	<b>Ref. No.</b> —
	flat gasket fibre ED ø 20mm ID ø 14mm thickness 2mm Qty 1 pcs		
	<b>Part No.</b>	520228	<b>Ref. No.</b> —
	tooth lock washer ID ø 15.3mm ED ø 24mm steel Qty 1 pcs for thread M14		
	<b>Part No.</b>	520230	<b>Ref. No.</b> —
	nut thread M14x1.5 H 5mm WS 19 zinc-coated steel Qty 1 pcs		
	<b>Part No.</b>	521101	<b>Ref. No.</b> 113000
	nut thread M14x1.5 H 5mm WS 19 SS Qty 1 pcs		
	<b>Part No.</b>	521103	<b>Ref. No.</b> —
	nut thread M4 H 3mm WS 7 brass Qty 20 pcs		
	<b>Part No.</b>	521104	<b>Ref. No.</b> —
	washer ID ø 4.3mm ED ø 8mm thickness 0.5mm brass Qty 20 pcs for thread M4		
	<b>Part No.</b>	550262	<b>Ref. No.</b> —
	flat gasket copper ED ø 20mm ID ø 14mm thickness 2mm		
	<b>Part No.</b>	560111	<b>Ref. No.</b> 120017
	plain washer ID ø 4.3mm ED ø 9mm thickness 0.8mm SS Qty 20 pcs DIN 125A for thread M4		
	<b>Part No.</b>	560131	<b>Ref. No.</b> —
	hexagonal nut thread M4 H 3.2mm WS 7 SS DIN/ISO DIN 934 / ISO 4032/8673 Qty 20 pcs		

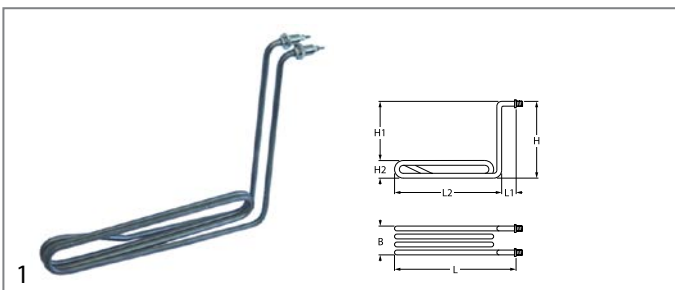


<b>Part No.</b>	415422	<b>Ref. No.</b>	572062 572064
-----------------	--------	-----------------	------------------

**description** heating element 2000W 230V heating circuits 1 L 300mm W 40mm H 240mm L1 20mm L2 280mm H1 195mm H2 45mm thread M14x1.5 mounting distance 25mm tube  $\varnothing$  8.5mm 2 hole fixing connection M4 connection length 20mm immersion heater windings 3 SS

**accessories for** 415422


	<b>Part No.</b>	510417	<b>Ref. No.</b>	—
		flat gasket fibre ED $\varnothing$ 20mm ID $\varnothing$ 14mm thickness 2mm Qty 1 pcs		
	<b>Part No.</b>	520228	<b>Ref. No.</b>	—
		tooth lock washer ID $\varnothing$ 15.3mm ED $\varnothing$ 24mm steel Qty 1 pcs for thread M14		
	<b>Part No.</b>	520230	<b>Ref. No.</b>	—
		nut thread M14x1.5 H 5mm WS 19 zinc-coated steel Qty 1 pcs		
	<b>Part No.</b>	521101	<b>Ref. No.</b>	113000
		nut thread M14x1.5 H 5mm WS 19 SS Qty 1 pcs		
	<b>Part No.</b>	521103	<b>Ref. No.</b>	—
		nut thread M4 H 3mm WS 7 brass Qty 20 pcs		
	<b>Part No.</b>	521104	<b>Ref. No.</b>	—
		washer ID $\varnothing$ 4.3mm ED $\varnothing$ 8mm thickness 0.5mm brass Qty 20 pcs for thread M4		
	<b>Part No.</b>	550262	<b>Ref. No.</b>	—
		flat gasket copper ED $\varnothing$ 20mm ID $\varnothing$ 14mm thickness 2mm		
	<b>Part No.</b>	560111	<b>Ref. No.</b>	120017
		plain washer ID $\varnothing$ 4.3mm ED $\varnothing$ 9mm thickness 0.8mm SS Qty 20 pcs DIN 125A for thread M4		
	<b>Part No.</b>	560131	<b>Ref. No.</b>	—
		hexagonal nut thread M4 H 3.2mm WS 7 SS DIN/ISO DIN 934 / ISO 4032/8673 Qty 20 pcs		



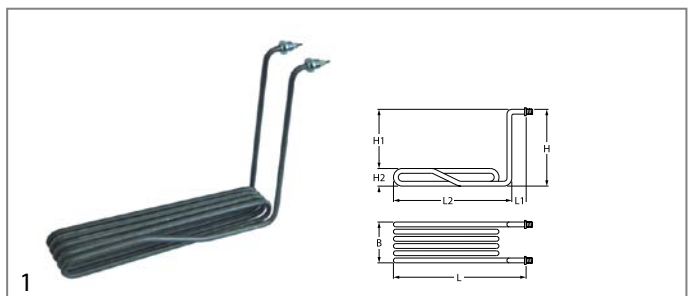
<b>Part No.</b>	415746	<b>Ref. No.</b>	N/A
-----------------	--------	-----------------	-----

**description** heating element 3300W 230V heating circuits 1 L 320mm W 40mm H 250mm L1 20mm L2 300mm H1 210mm H2 40mm thread M14x1.5 tube  $\varnothing$  8.5mm 2 hole fixing connection M4 fryer heaters windings 3

**accessories for** 415746

	<b>Part No.</b>	510417	<b>Ref. No.</b>	—
		flat gasket fibre ED $\varnothing$ 20mm ID $\varnothing$ 14mm thickness 2mm Qty 1 pcs		

<b>accessories for</b>	415746			
	<b>Part No.</b>	520228	<b>Ref. No.</b>	—
		tooth lock washer ID $\varnothing$ 15.3mm ED $\varnothing$ 24mm steel Qty 1 pcs for thread M14		
	<b>Part No.</b>	520230	<b>Ref. No.</b>	—
		nut thread M14x1.5 H 5mm WS 19 zinc-coated steel Qty 1 pcs		
	<b>Part No.</b>	521101	<b>Ref. No.</b>	113000
		nut thread M14x1.5 H 5mm WS 19 SS Qty 1 pcs		
	<b>Part No.</b>	521103	<b>Ref. No.</b>	—
		nut thread M4 H 3mm WS 7 brass Qty 20 pcs		
	<b>Part No.</b>	521104	<b>Ref. No.</b>	—
		washer ID $\varnothing$ 4.3mm ED $\varnothing$ 8mm thickness 0.5mm brass Qty 20 pcs for thread M4		
	<b>Part No.</b>	550262	<b>Ref. No.</b>	—
		flat gasket copper ED $\varnothing$ 20mm ID $\varnothing$ 14mm thickness 2mm		
	<b>Part No.</b>	560111	<b>Ref. No.</b>	120017
		plain washer ID $\varnothing$ 4.3mm ED $\varnothing$ 9mm thickness 0.8mm SS Qty 20 pcs DIN 125A for thread M4		
	<b>Part No.</b>	560131	<b>Ref. No.</b>	—
		hexagonal nut thread M4 H 3.2mm WS 7 SS DIN/ISO DIN 934 / ISO 4032/8673 Qty 20 pcs		



<b>Part No.</b>	415819	<b>Ref. No.</b>	572049
-----------------	--------	-----------------	--------

**description** heating element 3300W 230V heating circuits 1 L 339mm W 68mm H 235mm L1 17mm L2 322mm H1 200mm H2 35mm thread M14x1.5 mounting distance 60mm tube  $\varnothing$  8.5mm 2 hole fixing connection M4 immersion heater windings 5




**spare parts for** 415819

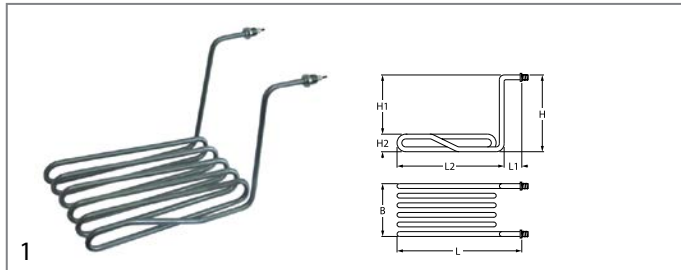
	<b>Part No.</b>	510417	<b>Ref. No.</b>	—
		flat gasket fibre ED $\varnothing$ 20mm ID $\varnothing$ 14mm thickness 2mm Qty 1 pcs		
<b>accessories for</b>	415819			
	<b>Part No.</b>	520228	<b>Ref. No.</b>	—
		tooth lock washer ID $\varnothing$ 15.3mm ED $\varnothing$ 24mm steel Qty 1 pcs for thread M14		
	<b>Part No.</b>	520230	<b>Ref. No.</b>	—
		nut thread M14x1.5 H 5mm WS 19 zinc-coated steel Qty 1 pcs		
	<b>Part No.</b>	521101	<b>Ref. No.</b>	113000
		nut thread M14x1.5 H 5mm WS 19 SS Qty 1 pcs		
	<b>Part No.</b>	521103	<b>Ref. No.</b>	—
		nut thread M4 H 3mm WS 7 brass Qty 20 pcs		
	<b>Part No.</b>	521104	<b>Ref. No.</b>	—
		washer ID $\varnothing$ 4.3mm ED $\varnothing$ 8mm thickness 0.5mm brass Qty 20 pcs for thread M4		

Table continues overleaf



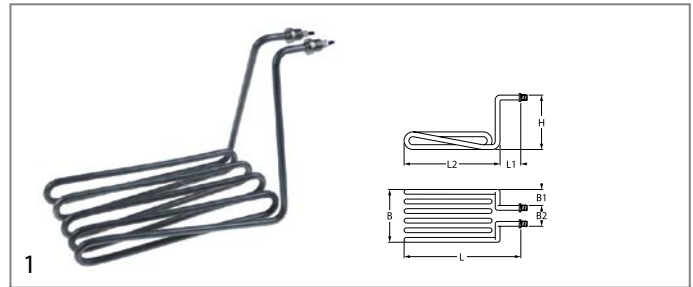


accessories for		415819	
	Part No.	550262	Ref. No. —
flat gasket copper ED ø 20mm ID ø 14mm thickness 2mm			
	Part No.	560111	Ref. No. 120017
plain washer ID ø 4.3mm ED ø 9mm thickness 0.8mm SS Qty 20 pcs DIN 125A for thread M4			
	Part No.	560131	Ref. No. —
hexagonal nut thread M4 H 3.2mm WS 7 SS DIN/ISO DIN 934 / ISO 4032/8673 Qty 20 pcs			

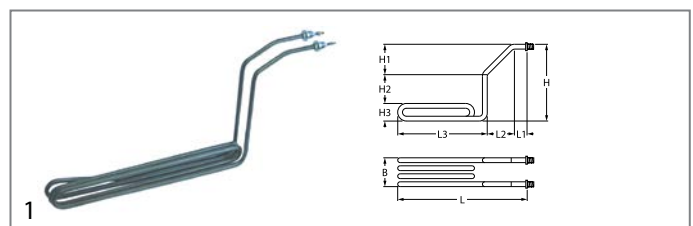


Part No.	415764	Ref. No.	572168
572168+ 2 x 113000+ 2 x 121216			
description	heating element 3300W 230V heating circuits 1 L 320mm W 138mm H 182mm L1 56mm L2 264mm H1 145mm H2 37mm thread M14x1.5 mounting distance 124mm tube ø 8.5mm 2 hole fixing connection M4 immersion heater windings 6		
For models:	1820301-00, 1820301-01, 1820301-02		

accessories for		415764	
	Part No.	510417	Ref. No. —
flat gasket fibre ED ø 20mm ID ø 14mm thickness 2mm Qty 1 pcs			
	Part No.	520228	Ref. No. —
tooth lock washer ID ø 15.3mm ED ø 24mm steel Qty 1 pcs for thread M14			
	Part No.	520230	Ref. No. —
nut thread M14x1.5 H 5mm WS 19 zinc-coated steel Qty 1 pcs			
	Part No.	521101	Ref. No. 113000
nut thread M14x1.5 H 5mm WS 19 SS Qty 1 pcs			
	Part No.	521103	Ref. No. —
nut thread M4 H 3mm WS 7 brass Qty 20 pcs			
	Part No.	521104	Ref. No. —
washer ID ø 4.3mm ED ø 8mm thickness 0.5mm brass Qty 20 pcs for thread M4			
	Part No.	550262	Ref. No. —
flat gasket copper ED ø 20mm ID ø 14mm thickness 2mm			
	Part No.	560111	Ref. No. 120017
plain washer ID ø 4.3mm ED ø 9mm thickness 0.8mm SS Qty 20 pcs DIN 125A for thread M4			
	Part No.	560131	Ref. No. —
hexagonal nut thread M4 H 3.2mm WS 7 SS DIN/ISO DIN 934 / ISO 4032/8673 Qty 20 pcs			



Part No.	418857	Ref. No.	572088
description	heating element 2500W 230V heating circuits 1 L 290mm W 155mm H 198mm L1 44mm L2 246mm W1 50mm W2 55mm H1 162mm H2 36mm tube ø 8.5mm connection M4 thread M14x1.5 2 hole fixing windings 5 mounting distance 46mm immersion heater connection length 30mm		

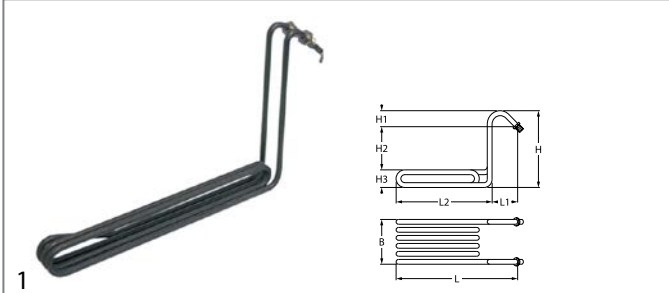






Part No.	415713	Ref. No.	572069
description	heating element 2000W 220V heating circuits 1 L 465mm W 40mm H 205mm 2 hole fixing connection M4 fryer heaters L1 60mm L2 55mm L3 350mm H1 35mm H2 129mm H3 41mm tube ø 8.5mm thread M14x1.5 mounting distance 25mm connection length 20mm		





spare parts for		415713	
	Part No.	510417	Ref. No. —
flat gasket fibre ED ø 20mm ID ø 14mm thickness 2mm Qty 1 pcs			
accessories for		415713	
	Part No.	520228	Ref. No. —
tooth lock washer ID ø 15.3mm ED ø 24mm steel Qty 1 pcs for thread M14			
	Part No.	520230	Ref. No. —
nut thread M14x1.5 H 5mm WS 19 zinc-coated steel Qty 1 pcs			
	Part No.	521101	Ref. No. 113000
nut thread M14x1.5 H 5mm WS 19 SS Qty 1 pcs			
	Part No.	521103	Ref. No. —
nut thread M4 H 3mm WS 7 brass Qty 20 pcs			
	Part No.	521104	Ref. No. —
washer ID ø 4.3mm ED ø 8mm thickness 0.5mm brass Qty 20 pcs for thread M4			
	Part No.	550262	Ref. No. —
flat gasket copper ED ø 20mm ID ø 14mm thickness 2mm			
	Part No.	560111	Ref. No. 120017
plain washer ID ø 4.3mm ED ø 9mm thickness 0.8mm SS Qty 20 pcs DIN 125A for thread M4			
	Part No.	560131	Ref. No. —
hexagonal nut thread M4 H 3.2mm WS 7 SS DIN/ISO DIN 934 / ISO 4032/8673 Qty 20 pcs			

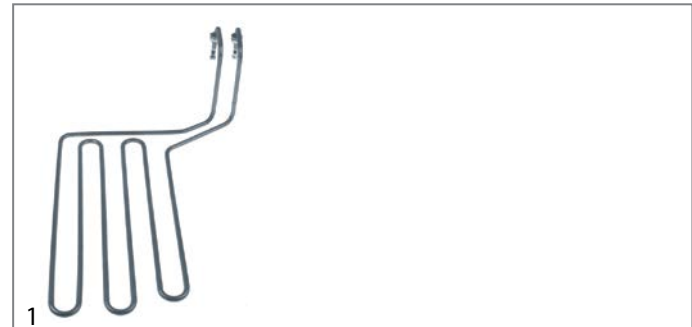










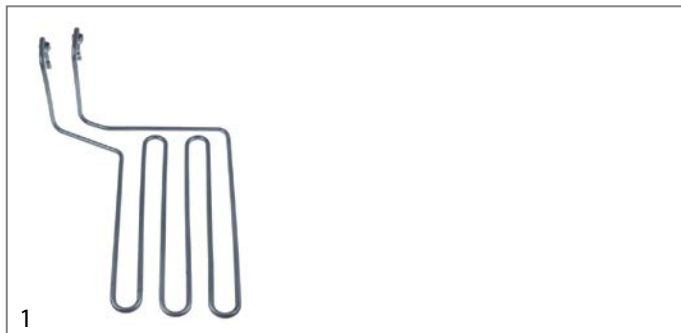


			
<b>Part No.</b>	415710	<b>Ref. No.</b>	572076
<b>description</b>	heating element 2000W 230V heating circuits 1 L 370mm W 30mm H 235mm L1 25mm L2 355mm H2 195mm H3 40mm thread M14x1.5 mounting distance 35mm tube $\varnothing$ 8.5mm 2 hole fixing connection male faston 6.3mm immersion heater windings 3		
<b>spare parts for</b>	415710		
	<b>Part No.</b>	510417	<b>Ref. No.</b> —
	flat gasket fibre ED $\varnothing$ 20mm ID $\varnothing$ 14mm thickness 2mm Qty 1 pcs		
<b>accessories for</b>	415710		
	<b>Part No.</b>	520228	<b>Ref. No.</b> —
	tooth lock washer ID $\varnothing$ 15.3mm ED $\varnothing$ 24mm steel Qty 1 pcs for thread M14		
	<b>Part No.</b>	520230	<b>Ref. No.</b> —
	nut thread M14x1.5 H 5mm WS 19 zinc-coated steel Qty 1 pcs		
	<b>Part No.</b>	521101	<b>Ref. No.</b> 113000
	nut thread M14x1.5 H 5mm WS 19 SS Qty 1 pcs		
	<b>Part No.</b>	550262	<b>Ref. No.</b> —
	flat gasket copper ED $\varnothing$ 20mm ID $\varnothing$ 14mm thickness 2mm		

			
<b>Part No.</b>	418311	<b>Ref. No.</b>	572026
<b>description</b>	heating element 3300W 230V heating circuits 1 mounting pos. centre L 490mm W 300mm H 190mm 2 hole fixing connection M4 fryer heaters L1 60mm L2 430mm W1 113mm W2 75mm tube $\varnothing$ 8.5mm thread M14x1.5 mounting distance 68mm windings 4		
<b>accessories for</b>	418311		
	<b>Part No.</b>	510417	<b>Ref. No.</b> —
	flat gasket fibre ED $\varnothing$ 20mm ID $\varnothing$ 14mm thickness 2mm Qty 1 pcs		
	<b>Part No.</b>	520228	<b>Ref. No.</b> —
	tooth lock washer ID $\varnothing$ 15.3mm ED $\varnothing$ 24mm steel Qty 1 pcs for thread M14		
	<b>Part No.</b>	520230	<b>Ref. No.</b> —
	nut thread M14x1.5 H 5mm WS 19 zinc-coated steel Qty 1 pcs		
	<b>Part No.</b>	521101	<b>Ref. No.</b> 113000
	nut thread M14x1.5 H 5mm WS 19 SS Qty 1 pcs		
	<b>Part No.</b>	521103	<b>Ref. No.</b> —
	nut thread M4 H 3mm WS 7 brass Qty 20 pcs		

<b>accessories for</b>	418311		
	<b>Part No.</b>	521104	<b>Ref. No.</b> —
	washer ID $\varnothing$ 4.3mm ED $\varnothing$ 8mm thickness 0.5mm brass Qty 20 pcs for thread M4		
	<b>Part No.</b>	550262	<b>Ref. No.</b> —
	flat gasket copper ED $\varnothing$ 20mm ID $\varnothing$ 14mm thickness 2mm		
	<b>Part No.</b>	560111	<b>Ref. No.</b> 120017
	plain washer ID $\varnothing$ 4.3mm ED $\varnothing$ 9mm thickness 0.8mm SS Qty 20 pcs DIN 125A for thread M4		
	<b>Part No.</b>	560131	<b>Ref. No.</b> —
	hexagonal nut thread M4 H 3.2mm WS 7 SS DIN/ISO DIN 934 / ISO 4032/8673 Qty 20 pcs		

			
<b>Part No.</b>	418313	<b>Ref. No.</b>	572027
<b>description</b>	heating element 3300W 230V heating circuits 1 mounting pos. left L 500mm W 335mm H 170mm 2 hole fixing connection M4 fryer heaters L1 100mm L2 410mm W1 135mm W2 200mm tube $\varnothing$ 8.5mm thread M14x1.5 mounting distance 50mm connection length 46mm windings 3		
<b>accessories for</b>	418313		
	<b>Part No.</b>	510417	<b>Ref. No.</b> —
	flat gasket fibre ED $\varnothing$ 20mm ID $\varnothing$ 14mm thickness 2mm Qty 1 pcs		
	<b>Part No.</b>	520228	<b>Ref. No.</b> —
	tooth lock washer ID $\varnothing$ 15.3mm ED $\varnothing$ 24mm steel Qty 1 pcs for thread M14		
	<b>Part No.</b>	520230	<b>Ref. No.</b> —
	nut thread M14x1.5 H 5mm WS 19 zinc-coated steel Qty 1 pcs		
	<b>Part No.</b>	521101	<b>Ref. No.</b> 113000
	nut thread M14x1.5 H 5mm WS 19 SS Qty 1 pcs		
	<b>Part No.</b>	521103	<b>Ref. No.</b> —
	nut thread M4 H 3mm WS 7 brass Qty 20 pcs		
	<b>Part No.</b>	521104	<b>Ref. No.</b> —
	washer ID $\varnothing$ 4.3mm ED $\varnothing$ 8mm thickness 0.5mm brass Qty 20 pcs for thread M4		
	<b>Part No.</b>	550262	<b>Ref. No.</b> —
	flat gasket copper ED $\varnothing$ 20mm ID $\varnothing$ 14mm thickness 2mm		
	<b>Part No.</b>	560111	<b>Ref. No.</b> 120017
	plain washer ID $\varnothing$ 4.3mm ED $\varnothing$ 9mm thickness 0.8mm SS Qty 20 pcs DIN 125A for thread M4		
	<b>Part No.</b>	560131	<b>Ref. No.</b> —
	hexagonal nut thread M4 H 3.2mm WS 7 SS DIN/ISO DIN 934 / ISO 4032/8673 Qty 20 pcs		



<b>Part No.</b>	418312	<b>Ref. No.</b>	572025
<b>description</b>	heating element 3300W 230V mounting pos. right L 500mm W 335mm H 170mm 2 hole fixing connection M4 fryer heaters L1 100mm L2 410mm W1 135mm W2 200mm tube ø 8.5mm thread M14x1.5 mounting distance 50mm connection length 46mm windings 3		
<b>accessories for</b>	418312		
	<b>Part No.</b>	510417	<b>Ref. No.</b> —
	flat gasket fibre ED ø 20mm ID ø 14mm thickness 2mm Qty 1 pcs		
	<b>Part No.</b>	520228	<b>Ref. No.</b> —
	tooth lock washer ID ø 15.3mm ED ø 24mm steel Qty 1 pcs for thread M14		
	<b>Part No.</b>	520230	<b>Ref. No.</b> —
	nut thread M14x1.5 H 5mm WS 19 zinc-coated steel Qty 1 pcs		
	<b>Part No.</b>	521101	<b>Ref. No.</b> 113000
	nut thread M14x1.5 H 5mm WS 19 SS Qty 1 pcs		
	<b>Part No.</b>	521103	<b>Ref. No.</b> —
	nut thread M4 H 3mm WS 7 brass Qty 20 pcs		
	<b>Part No.</b>	521104	<b>Ref. No.</b> —
	washer ID ø 4.3mm ED ø 8mm thickness 0.5mm brass Qty 20 pcs for thread M4		
	<b>Part No.</b>	550262	<b>Ref. No.</b> —
	flat gasket copper ED ø 20mm ID ø 14mm thickness 2mm		
	<b>Part No.</b>	560111	<b>Ref. No.</b> 120017
	plain washer ID ø 4.3mm ED ø 9mm thickness 0.8mm SS Qty 20 pcs DIN 125A for thread M4		
	<b>Part No.</b>	560131	<b>Ref. No.</b> —
	hexagonal nut thread M4 H 3.2mm WS 7 SS DIN/ISO DIN 934 / ISO 4032/8673 Qty 20 pcs		

<b>Part No.</b>	415446	<b>Ref. No.</b>	203550
<b>description</b>	heating element 1250W 230V heating circuits 1 L 450mm W 65mm H 60mm tube ø 6.5mm W1 43mm W2 25mm connection male faston 6.3mm connection length 24mm connection distance 19mm dry heating element		

<b>Part No.</b>	415425	<b>Ref. No.</b>	574099
<b>description</b>	heating element 1250W 230V heating circuits 1 L 470mm W 64mm H 60mm tube ø 6.5mm L1 230mm connection male faston 6.3mm connection length 25mm connection distance 15mm dry heating element		
<b>For models:</b>	0221101-00, 0221101-01, 0221101A00, 0221101A01, 0221102-00, 0221102-01, 0221103-00, 0221103-01, 0221104-00, 0221104-01, 0221104A00, 0221104A01, 0221105-00, 0221105-01, 0221106-00, 0221106-01, 1221101-00, 1221101A00, 1221101B00, 1221102-00, 1221102A00, 1221102B00, 1421101-00, 1421101A00, 1421102-00, 1421103-00, 1421104-00, 1421104A00, 1421105-00, 1421106-00, 1421107-00, 1421107A00, 1421108-00, 1421109-00, 1421110-00, 1421110A00, 1421111-00, 1421112-00, 2021101-00, 20211011-0, 2021101A00, 2021102-00, 20211022-0, 2021103-00, 20211033-0, 2021104-00, 20211044-0, 2021104A00, 2021105-00, 20211055-0... (Other models you can see in the webshop)		

<b>Part No.</b>	420543	<b>Ref. No.</b>	574162
<b>description</b>	heating element 2000W 400V heating circuits 1 L 320mm W 120mm H 144mm tube ø 6.5mm		
<b>For models:</b>	1423502-02, 1423502A02, 1423525A00, 1423527A00, 1523502A00, 2023502-07, 2023502A07, 2023503-13, 2023503A13, 2023525A00, 2223502-00, 2223502A00, 3023502-06, 3023502A06		

<b>Part No.</b>	418295	<b>Ref. No.</b>	574109
<b>description</b>	heating element 300W 230V heating circuits 1 L 481mm W 108mm H 50mm tube ø 8.5mm connection M4 connection distance 100mm dry heating element		
<b>For models:</b>	2123202A00, 2123202A01, 2123203A00, 2123203A01, 2123203A02, 2123203A03, 2123203A04, 2123204A00, 2123204A01, 2123204A02, 2123204A03, 2123204A04		

heating elements for griddles

<b>Part No.</b>	419246	<b>Ref. No.</b>	574156
<b>description</b>	heating element 1200W 230V heating circuits 1 L 534mm W 36mm H 65mm tube ø 8.5mm connection 6.3x0.8		
<b>For models:</b>	0721134-01, 0721134A01, 0721172A01, 0721173A01, 0721174A01, 0721175A01, 1021130A00, 1021135A00, 1221130J00, 1221141-00, 1221141A00, 1221156A00, 1222507-00, 1222509-00, 1321130-00, 1321130A00, 1321131-00, 1321131A00, 1321141-00, 1321141A00, 1322507-00, 1322509-00, 1421126B00, 1421127B00, 1421130B00, 1421131-00, 1421131A00, 1421131B00, 1421134-00, 1421134-01, 1421134A00, 1421134A01, 1421139-00, 1421139A00, 1421139B00, 1421141-00, 1421141A00, 1421141B00, 1421143B01, 1421144B01, 1421145B01, 1421149B00, 1421149B01, 1421150B00, 1421150B01, 1421151B00, 1421151B01, 1421155B02, 1421156B02, 1421157B02... (Other models you can see in the webshop)		



## heating elements for large hobs



<b>Part No.</b>	420361	<b>Ref. No.</b>	574151
<b>description</b>	heating element 4300W 400V heating circuits 1 L 450mm W 280mm H 100mm connection cable tube ø 13x6mm cable length 430mm dry heating element		
<b>For models:</b>	2021115-00, 2021115-01, 2021115-02, 2021115-03, 2021115-04, 2221115-00, 2221115-01		



<b>Part No.</b>	418255	<b>Ref. No.</b>	574114
<b>description</b>	heating element 600W 80V heating circuits 1 L 332mm W 54mm H 54mm tube ø 8.5mm mounting pos. connection male faston 6.3mm connection distance 45mm windings 1 dry heating element suitable for MKN series 700		
<b>For models:</b>	2020406A01, 2120406A00, 2120406A01, 2123502-00, 2123502-01, 2123502-02, 2123502A00, 2123502A01, 2123502A02, 2123503-00, 2123503-01, 2123503-02, 2123503-03, 2123503-04, 2123503-05, 2123503-06, 2123503A00, 2123503A01, 2123503A03, 2123503A04, 2123503A05, 2123503A06, 4228801-00, 4228801-01		

## heating elements for tilting bratt pan



<b>Part No.</b>	418303	<b>Ref. No.</b>	574107
<b>description</b>	heating element 1200W 230V L 510mm W 45mm Hmm connection male faston 6.3mm dry heating element heating circuits 1 tube ø 8.5mm connection distance 35mm		
<b>For models:</b>	0021135A00, 1220504-01, 1222601-00, 1320504-01, 1320504-02, 1322601-00, 1420509-01, 1422601-00, 1422602-00, 2020506-01, 2021401-04, 2021401-05, 2021401-06, 2021401-07, 2021401-08, 2021401-09, 2021401A03, 2021401A04, 2021401A06, 2021401A07, 2021401A08, 2021401A09, 2021401B03, 2021401B04, 2021401B06, 2021401B07, 2021401B08, 2021401B09, 2021401C03, 2021401C04, 2021401C06, 2021401C07, 2021401C08, 2021401C09, 2021402-04, 2021402-05, 2021402-06, 2021402-07, 2021402-08, 2021402A03, 2021402A04, 2021402A06, 2021402A07, 2021402A08, 2021402B03, 2021402B04, 2021402B06, 2021402B07, 2021402B08, 2021402C03... (Other models you can see in the webshop)		



<b>Part No.</b>	415475	<b>Ref. No.</b>	574084
<b>description</b>	heating element 1670W 230V L 110mm W 430mm H 45mm connection M4 dry heating element heating circuits 1 tube ø 8.5mm W1 200mm W2 30mm mounting pos. inner connection distance 22mm		

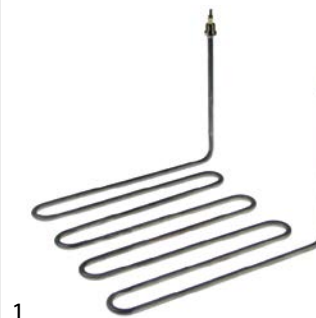


<b>Part No.</b>	415476	<b>Ref. No.</b>	574085
<b>description</b>	heating element 1670W 230V L 650mm W 470mm H 35mm connection M4 dry heating element heating circuits 1 tube ø 8.5mm W2 45mm mounting pos. outer connection distance 37mm		



<b>Part No.</b>	415477	<b>Ref. No.</b>	574102
<b>description</b>	heating element 1670W 230V L 95mm W 465mm H 45mm connection M4 dry heating element heating circuits 1 tube ø 8.5mm W1 220mm W2 25mm connection distance 16mm		
<b>For models:</b>	2021401-00, 2021401-01, 2021401-02, 2021401-03, 2021401A00, 2021401A01, 2021401A02, 2021401B00, 2021401B01, 2021401B02, 2021401C00, 2021401C01, 2021401C02, 2021402-00, 2021402-01, 2021402-02, 2021402-03, 2021402A00, 2021402A01, 2021402A02, 2021402B00, 2021402B01, 2021402B02, 2021402C00, 2021402C01, 2021402C02, 2021403-00, 2021403-01, 2021403-02, 20214033-0, 2021403A00, 2021403A01, 2021403B00, 2021403B01, 2021403C01, 2021404-00, 2021404-01, 2021404-02, 20214044-0, 2021404A00, 2021404A01, 2021404B00, 2021404B01, 2021404C00, 2021404C01, 2021405-00, 20214055-0, 2021405B00, 2021406-00, 20214066-0... (Other models you can see in the webshop)		

## heating elements for pasta cookers








<b>Part No.</b>	418326	<b>Ref. No.</b>	327649 572170
<b>description</b>	heating element 3300W 400V heating circuits 1 L 315mm W 310mm H 215mm 2 hole fixing connection M4 thread M14x1.5 tube ø 8.5mm stainless steel mounting distance 302mm connection length 21mm pasta cooker immersion heater		
<b>For models:</b>	1320401-00, 1320401-01, 1420401-00, 1420401-01, 2020401-00, 2020401-01, 2120401-00, 2120401-01		
<b>spare parts for</b>	418326		
	<b>Part No.</b>	510417	<b>Ref. No.</b> —
	flat gasket fibre ED ø 20mm ID ø 14mm thickness 2mm Qty 1 pcs		

Table continues overleaf

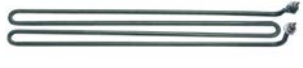







accessories for		418326	
	Part No.	520228	Ref. No. —
tooth lock washer ID ø 15.3mm ED ø 24mm steel Qty 1 pcs for thread M14			
	Part No.	520230	Ref. No. —
nut thread M14x1.5 H 5mm WS 19 zinc-coated steel Qty 1 pcs			
	Part No.	521101	Ref. No. 113000
nut thread M14x1.5 H 5mm WS 19 SS Qty 1 pcs			
	Part No.	550262	Ref. No. —
flat gasket copper ED ø 20mm ID ø 14mm thickness 2mm			

### heating elements for rechauds

1			
Part No.	415767	Ref. No.	573054 573054/113000/121216
description heating element 1500W 230V heating circuits 1 L 425mm W 250mm H 58mm W1 50mm W2 150mm L1 60mm L2 365mm thread M14x1.5 mounting distance 142mm windings 3 tube ø 8.5mm connection M4 dry heating element 2 hole fixing for stockpot			
accessories for		415767	
	Part No.	510417	Ref. No. —
flat gasket fibre ED ø 20mm ID ø 14mm thickness 2mm Qty 1 pcs			
	Part No.	520228	Ref. No. —
tooth lock washer ID ø 15.3mm ED ø 24mm steel Qty 1 pcs for thread M14			
	Part No.	520230	Ref. No. —
nut thread M14x1.5 H 5mm WS 19 zinc-coated steel Qty 1 pcs			
	Part No.	521101	Ref. No. 113000
nut thread M14x1.5 H 5mm WS 19 SS Qty 1 pcs			
	Part No.	521103	Ref. No. —
nut thread M4 H 3mm WS 7 brass Qty 20 pcs			
	Part No.	521104	Ref. No. —
washer ID ø 4.3mm ED ø 8mm thickness 0.5mm brass Qty 20 pcs for thread M4			
	Part No.	550262	Ref. No. —
flat gasket copper ED ø 20mm ID ø 14mm thickness 2mm			
	Part No.	560111	Ref. No. 120017
plain washer ID ø 4.3mm ED ø 9mm thickness 0.8mm SS Qty 20 pcs DIN 125A for thread M4			
	Part No.	560131	Ref. No. —
hexagonal nut thread M4 H 3.2mm WS 7 SS DIN/ISO DIN 934 / ISO 4032/8673 Qty 20 pcs			

### heating elements for chargrills

1			
Part No.	415522	Ref. No.	574091
description heating element 800W 380V L 480mm W 68mm H 74mm thread M14x1.5 mounting distance 37mm tube ø 8.5mm connection M4 heating circuits 1 2 hole fixing dry heating element W1 10mm W2 48mm			
accessories for		415522	
	Part No.	510417	Ref. No. —
flat gasket fibre ED ø 20mm ID ø 14mm thickness 2mm Qty 1 pcs			
	Part No.	520228	Ref. No. —
tooth lock washer ID ø 15.3mm ED ø 24mm steel Qty 1 pcs for thread M14			
	Part No.	520230	Ref. No. —
nut thread M14x1.5 H 5mm WS 19 zinc-coated steel Qty 1 pcs			
	Part No.	521101	Ref. No. 113000
nut thread M14x1.5 H 5mm WS 19 SS Qty 1 pcs			
	Part No.	550262	Ref. No. —
flat gasket copper ED ø 20mm ID ø 14mm thickness 2mm			


1			
Part No.	415427	Ref. No.	574027
description heating element 820W 95V L 504mm W 33mm H 105mm 2 hole fixing mounting distance 27mm connection M4 L1 27mm L2 477mm heating circuits 1 tube ø 8.5mm dry heating element thread M14x1.5			
accessories for		415427	
	Part No.	510417	Ref. No. —
flat gasket fibre ED ø 20mm ID ø 14mm thickness 2mm Qty 1 pcs			
	Part No.	520228	Ref. No. —
tooth lock washer ID ø 15.3mm ED ø 24mm steel Qty 1 pcs for thread M14			
	Part No.	520230	Ref. No. —
nut thread M14x1.5 H 5mm WS 19 zinc-coated steel Qty 1 pcs			
	Part No.	521101	Ref. No. 113000
nut thread M14x1.5 H 5mm WS 19 SS Qty 1 pcs			
	Part No.	550262	Ref. No. —
flat gasket copper ED ø 20mm ID ø 14mm thickness 2mm			









			
<b>Part No.</b>	415426	<b>Ref. No.</b>	574097
<b>description</b>	heating element 870W 95V L 495mm W 35mm H 73mm thread M14x1.5 mounting distance 35mm tube ø 8.5mm connection M4 heating circuits 1 connection length 20mm 2 hole fixing dry heating element		
<b>For models:</b>	0221501-00, 0221502-00, 1421501-00, 1421502-00, 1421503-00, 1421504-00, 2121501-00, 2121502-00		
<b>accessories for</b>	415426		
	<b>Part No.</b>	510417	<b>Ref. No.</b> —
	<b>Part No.</b>	520228	<b>Ref. No.</b> —
	<b>Part No.</b>	520230	<b>Ref. No.</b> —
	<b>Part No.</b>	521101	<b>Ref. No.</b> 113000
	<b>Part No.</b>	550262	<b>Ref. No.</b> —

## heating elements for salamanders/toast-

			
<b>Part No.</b>	415730	<b>Ref. No.</b>	N/A
<b>description</b>	heating element 1100W 230V L 275mm W 143mm 2 hole fixing thread M14x1.5 mounting distance 137mm connection M4 dry heating element tube ø 8.5mm heating circuits 1		
<b>accessories for</b>	415730		
	<b>Part No.</b>	510417	<b>Ref. No.</b> —
	<b>Part No.</b>	520228	<b>Ref. No.</b> —
	<b>Part No.</b>	520230	<b>Ref. No.</b> —
	<b>Part No.</b>	521101	<b>Ref. No.</b> 113000
	<b>Part No.</b>	521103	<b>Ref. No.</b> —
	<b>Part No.</b>	521104	<b>Ref. No.</b> —
	<b>Part No.</b>	550262	<b>Ref. No.</b> —
	<b>Part No.</b>	560111	<b>Ref. No.</b> 120017

<b>accessories for</b>	415730		
	<b>Part No.</b>	560131	<b>Ref. No.</b> —

			
<b>Part No.</b>	415418	<b>Ref. No.</b>	203556 574095
<b>description</b>	heating element 1650W 230V L 260mm W 250mm 2 hole fixing thread M14x1.5 mounting distance 243mm connection male faston 6.3mm dry heating element tube ø 6.5mm heating circuits 1 connection length 20mm H 6.5mm		
<b>For models:</b>	00217022-0, 0521702-00, 0521702-01, 0521702-02, 0521702-03, 0521702-04, 0521702C04		
<b>accessories for</b>	415418		
	<b>Part No.</b>	510417	<b>Ref. No.</b> —
	<b>Part No.</b>	520228	<b>Ref. No.</b> —
	<b>Part No.</b>	520230	<b>Ref. No.</b> —
	<b>Part No.</b>	521101	<b>Ref. No.</b> 113000
	<b>Part No.</b>	550262	<b>Ref. No.</b> —

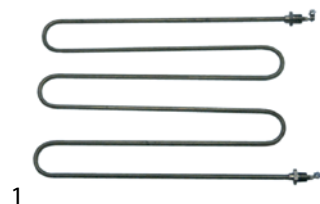





			
<b>Part No.</b>	415514	<b>Ref. No.</b>	574116 720003
<b>description</b>	heating element 1650W 230V L 315mm W 200mm 2 hole fixing thread M14x1.5 mounting distance 193mm connection M4 dry heating element tube ø 6.3mm heating circuits 1 H 6.3mm		
<b>For models:</b>	0521704-04, 0521704-05, 0521704-06, 0521704-07		
<b>spare parts for</b>	415514		
	<b>Part No.</b>	510417	<b>Ref. No.</b> —
<b>accessories for</b>	415514		
	<b>Part No.</b>	520228	<b>Ref. No.</b> —
	<b>Part No.</b>	520230	<b>Ref. No.</b> —

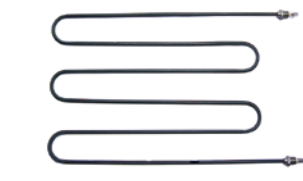





Table continues overleaf





<b>accessories for</b> 415514			
	<b>Part No.</b> 521101	<b>Ref. No.</b>	113000
	nut thread M14x1.5 H 5mm WS 19 SS Qty 1 pcs		
	<b>Part No.</b> 521103	<b>Ref. No.</b>	—
	nut thread M4 H 3mm WS 7 brass Qty 20 pcs		
	<b>Part No.</b> 521104	<b>Ref. No.</b>	—
	washer ID ø 4.3mm ED ø 8mm thickness 0.5mm brass Qty 20 pcs for thread M4		
	<b>Part No.</b> 550262	<b>Ref. No.</b>	—
	flat gasket copper ED ø 20mm ID ø 14mm thickness 2mm		
	<b>Part No.</b> 560111	<b>Ref. No.</b>	120017
	plain washer ID ø 4.3mm ED ø 9mm thickness 0.8mm SS Qty 20 pcs DIN 125A for thread M4		
	<b>Part No.</b> 560131	<b>Ref. No.</b>	—
	hexagonal nut thread M4 H 3.2mm WS 7 SS DIN/ISO DIN 934 / ISO 4032/8673 Qty 20 pcs		

 <p>1</p>			
<b>Part No.</b>	415519	<b>Ref. No.</b>	574035
<b>description</b>	heating element 2000W 230V L 615mm W 100mm 2 hole fixing thread M14x1.5 mounting distance 87mm connection M4 dry heating element tube ø 8.5mm heating circuits 1 connection length 58mm		
<b>accessories for</b> 415519			
	<b>Part No.</b> 510417	<b>Ref. No.</b>	—
	flat gasket fibre ED ø 20mm ID ø 14mm thickness 2mm Qty 1 pcs		
	<b>Part No.</b> 520228	<b>Ref. No.</b>	—
	tooth lock washer ID ø 15.3mm ED ø 24mm steel Qty 1 pcs for thread M14		
	<b>Part No.</b> 520230	<b>Ref. No.</b>	—
	nut thread M14x1.5 H 5mm WS 19 zinc-coated steel Qty 1 pcs		
	<b>Part No.</b> 521101	<b>Ref. No.</b>	113000
	nut thread M14x1.5 H 5mm WS 19 SS Qty 1 pcs		
	<b>Part No.</b> 521103	<b>Ref. No.</b>	—
	nut thread M4 H 3mm WS 7 brass Qty 20 pcs		
	<b>Part No.</b> 521104	<b>Ref. No.</b>	—
	washer ID ø 4.3mm ED ø 8mm thickness 0.5mm brass Qty 20 pcs for thread M4		
	<b>Part No.</b> 550262	<b>Ref. No.</b>	—
	flat gasket copper ED ø 20mm ID ø 14mm thickness 2mm		
	<b>Part No.</b> 560111	<b>Ref. No.</b>	120017
	plain washer ID ø 4.3mm ED ø 9mm thickness 0.8mm SS Qty 20 pcs DIN 125A for thread M4		
	<b>Part No.</b> 560131	<b>Ref. No.</b>	—
	hexagonal nut thread M4 H 3.2mm WS 7 SS DIN/ISO DIN 934 / ISO 4032/8673 Qty 20 pcs		

 <p>1</p>			
<b>Part No.</b>	415417	<b>Ref. No.</b>	203553 574094
<b>description</b>	heating element 2500W 230V L 425mm W 260mm 2 hole fixing thread M14x1.5 mounting distance 247mm connection male faston 6.3mm dry heating element tube ø 6.5mm heating circuits 1 H 6.5mm		
<b>For models:</b>	0521701-00, 0521701-01		
<b>spare parts for</b> 415417			
	<b>Part No.</b> 510417	<b>Ref. No.</b>	—
	flat gasket fibre ED ø 20mm ID ø 14mm thickness 2mm Qty 1 pcs		
<b>accessories for</b> 415417			
	<b>Part No.</b> 520228	<b>Ref. No.</b>	—
	tooth lock washer ID ø 15.3mm ED ø 24mm steel Qty 1 pcs for thread M14		
	<b>Part No.</b> 520230	<b>Ref. No.</b>	—
	nut thread M14x1.5 H 5mm WS 19 zinc-coated steel Qty 1 pcs		
	<b>Part No.</b> 521101	<b>Ref. No.</b>	113000
	nut thread M14x1.5 H 5mm WS 19 SS Qty 1 pcs		
	<b>Part No.</b> 550262	<b>Ref. No.</b>	—
	flat gasket copper ED ø 20mm ID ø 14mm thickness 2mm		











 <p>1</p>			
<b>Part No.</b>	415817	<b>Ref. No.</b>	574032 574032+2x113000+2x121216
<b>description</b>	heating element 3300W 230V L 490mm W 260mm 2 hole fixing thread M14x1.5 mounting distance 252mm connection M4 dry heating element tube ø 8.5mm heating circuits 1 connection length 20mm H 8.5mm		
<b>spare parts for</b> 415817			
	<b>Part No.</b> 510417	<b>Ref. No.</b>	—
	flat gasket fibre ED ø 20mm ID ø 14mm thickness 2mm Qty 1 pcs		
<b>accessories for</b> 415817			
	<b>Part No.</b> 520228	<b>Ref. No.</b>	—
	tooth lock washer ID ø 15.3mm ED ø 24mm steel Qty 1 pcs for thread M14		
	<b>Part No.</b> 520230	<b>Ref. No.</b>	—
	nut thread M14x1.5 H 5mm WS 19 zinc-coated steel Qty 1 pcs		
	<b>Part No.</b> 521101	<b>Ref. No.</b>	113000
	nut thread M14x1.5 H 5mm WS 19 SS Qty 1 pcs		







Table continues overleaf











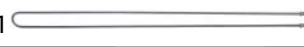





accessories for		415817		
	Part No.	521103	Ref. No.	—
nut thread M4 H 3mm WS 7 brass Qty 20 pcs				
	Part No.	521104	Ref. No.	—
washer ID ø 4.3mm ED ø 8mm thickness 0.5mm brass Qty 20 pcs for thread M4				
	Part No.	550262	Ref. No.	—
flat gasket copper ED ø 20mm ID ø 14mm thickness 2mm				
	Part No.	560111	Ref. No.	120017
plain washer ID ø 4.3mm ED ø 9mm thickness 0.8mm SS Qty 20 pcs DIN 125A for thread M4				
	Part No.	560131	Ref. No.	—
hexagonal nut thread M4 H 3.2mm WS 7 SS DIN/ISO DIN 934 / ISO 4032/8673 Qty 20 pcs				







## heating elements for heating bridges

Part No.		416444			Ref. No.			574059		
										
description		heating element 1000W 230V heating circuits 1 L 627mm W 70mm connection length 20mm connection M4 tube ø 8.5mm 2 hole fixing thread M14x1.5 dry heating element heated bridge mounting distance 62mm								
For models:		0524302-00, 0524302-01								
accessories for		416444								
	Part No.	510417	Ref. No.	—						
flat gasket fibre ED ø 20mm ID ø 14mm thickness 2mm Qty 1 pcs										
	Part No.	520228	Ref. No.	—						
tooth lock washer ID ø 15.3mm ED ø 24mm steel Qty 1 pcs for thread M14										
	Part No.	520230	Ref. No.	—						
nut thread M14x1.5 H 5mm WS 19 zinc-coated steel Qty 1 pcs										
	Part No.	521101	Ref. No.	113000						
nut thread M14x1.5 H 5mm WS 19 SS Qty 1 pcs										
	Part No.	550262	Ref. No.	—						
flat gasket copper ED ø 20mm ID ø 14mm thickness 2mm										

Part No.		416445			Ref. No.			574060		
										
description		heating element 1400W 230V heating circuits 1 L 875mm W 70mm connection length 20mm connection M4 tube ø 8.5mm 2 hole fixing thread M14x1.5 dry heating element heated bridge mounting distance 62mm								
For models:		0524303-00, 0524303-01								
accessories for		416445								
	Part No.	510417	Ref. No.	—						
flat gasket fibre ED ø 20mm ID ø 14mm thickness 2mm Qty 1 pcs										
	Part No.	520228	Ref. No.	—						
tooth lock washer ID ø 15.3mm ED ø 24mm steel Qty 1 pcs for thread M14										
	Part No.	520230	Ref. No.	—						
nut thread M14x1.5 H 5mm WS 19 zinc-coated steel Qty 1 pcs										

accessories for		416445		
	Part No.	521101	Ref. No.	113000
nut thread M14x1.5 H 5mm WS 19 SS Qty 1 pcs				
	Part No.	550262	Ref. No.	—
flat gasket copper ED ø 20mm ID ø 14mm thickness 2mm				

Part No.		416446			Ref. No.			574061		
										
description		heating element 1800W 230V heating circuits 1 L 1125mm W 70mm connection length 19mm connection M4 tube ø 8.5mm 2 hole fixing thread M14x1.5 dry heating element heated bridge mounting distance 61mm								
For models:		0524304-00, 0524304-01								
accessories for		416446								
	Part No.	510417	Ref. No.	—						
flat gasket fibre ED ø 20mm ID ø 14mm thickness 2mm Qty 1 pcs										
	Part No.	520228	Ref. No.	—						
tooth lock washer ID ø 15.3mm ED ø 24mm steel Qty 1 pcs for thread M14										
	Part No.	520230	Ref. No.	—						
nut thread M14x1.5 H 5mm WS 19 zinc-coated steel Qty 1 pcs										
	Part No.	521101	Ref. No.	113000						
nut thread M14x1.5 H 5mm WS 19 SS Qty 1 pcs										
	Part No.	550262	Ref. No.	—						
flat gasket copper ED ø 20mm ID ø 14mm thickness 2mm										



Part No.		416443			Ref. No.			574058		
										
description		heating element 600W 230V heating circuits 1 L 375mm W 67mm connection M4 tube ø 8.5mm 2 hole fixing thread M14x1.5 dry heating element heated bridge mounting distance 59mm								
For models:		0524301-00, 0524301-01								
accessories for		416443								
	Part No.	510417	Ref. No.	—						
flat gasket fibre ED ø 20mm ID ø 14mm thickness 2mm Qty 1 pcs										
	Part No.	520228	Ref. No.	—						
tooth lock washer ID ø 15.3mm ED ø 24mm steel Qty 1 pcs for thread M14										
	Part No.	520230	Ref. No.	—						
nut thread M14x1.5 H 5mm WS 19 zinc-coated steel Qty 1 pcs										
	Part No.	521101	Ref. No.	113000						
nut thread M14x1.5 H 5mm WS 19 SS Qty 1 pcs										
	Part No.	550262	Ref. No.	—						
flat gasket copper ED ø 20mm ID ø 14mm thickness 2mm										



ceramic heaters

245x60mm



1			
<b>Part No.</b>	415104	<b>Ref. No.</b>	203055
<b>description</b>	ceramic emitter 1000W 230V cable beaded cord L 245mm W 60mm H 35mm		
<b>For models:</b>	0220601-00, 1220601-00, 1320601-00, 1320601-01, 1420601-00, 1420701-00, 1420702-00, 1520601-00, 2020601-00, 2020601-01, 2120601-00, 2120601-01		
<b>spare parts for</b>	415104		
	<b>Part No.</b>	415109	<b>Ref. No.</b> —
	spring clip		
<b>accessories for</b>	415104		
	<b>Part No.</b>	415110	<b>Ref. No.</b> —
	reflector L 245mm W 95mm H 31mm thickness 0.75mm hole ø 15x40mm		

immersion heating elements



with expansion flange 70 x 18mm









1			
<b>Part No.</b>	415569	<b>Ref. No.</b>	573108 720012
<b>description</b>	heating element 5000W 230V heating circuits 2 L 272mm W 65mm H 29mm tube ø 8.5mm connection male faston 6.3mm immersion heater expansion flange flange 70x18mm		
<b>For models:</b>	2022801-02, 2022801-03, 2022801A02, 2022801A03, 2022801B02, 2022801B03, 2022801C02, 2022801C03, 2022802-02, 2022802-03, 2022802A02, 2022802A03, 2022802B02, 2022802B03, 2022802C02, 2022802C03, 2022803-02, 2022803-03, 2022803A02, 2022803A03, 2022803B02, 2022803B03, 2022803C02, 2022803C03, 2022804-02, 2022804-03, 2022804A02, 2022804A03, 2022804B02, 2022804B03, 2022804C02, 2022804C03, 2022805-02, 2022805-03, 2022805A02, 2022805A03, 2022805B02, 2022805B03, 2022805C02, 2022805C03, 2122801-02, 2122801-03, 2122801A02, 2122801A03, 2122801B02, 2122801B03, 2122801C02, 2122801C03, 2122802-02, 2122802-03... (Other models you can see in the webshop)		




1			
<b>Part No.</b>	419053	<b>Ref. No.</b>	573107
<b>description</b>	heating element 5000W 400V heating circuits 2 L 272mm W 65mm tube ø 8.5mm connection male faston 6.3mm connection length 38mm immersion heater expansion flange flange 70x18mm		
<b>For models:</b>	1422802B04, 1422802B05, 1422802B06, 1422802B07, 1422802B08, 1422804B04, 1422804B05, 1422804B06, 1422804B07, 1422804B08, 1422805B04, 1422805B05, 1422805B06, 1422805B07, 1422805B08, 1422807B00, 1422807B01, 1422807B02, 1422807B03, 1422807B04, 1422831-00, 1422832-00, 1422833-00, 1422834-00, 1422902-00, 1422902-01, 1422902-02, 1422902-03, 1422902-04, 1422908-00, 1422910-00, 1423901-00, 1423901-01, 1423901-02, 1423902-00, 1423902-01, 1423902-02, 1423903-00, 1423903-01, 1423903-02, 2022802B04, 2022802B05, 2022802B06, 2022802B07, 2022802B08, 2022802B09, 2022802B10, 2022802C07, 2022802C08, 2022802C09... (Other models you can see in the webshop)		



1			
			
<b>Part No.</b>	415568	<b>Ref. No.</b>	573106 720011
<b>description</b>	heating element 800W 230V heating circuits 1 L 220mm W 66mm tube ø 8.5mm connection male faston 6.3mm connection length 27mm immersion heater expansion flange TD ø 8mm flange 70x18mm		
<b>For models:</b>	1422802B04, 1422802B05, 1422802B06, 1422802B07, 1422802B08, 1422804B04, 1422804B05, 1422804B06, 1422804B07, 1422804B08, 1422805B04, 1422805B05, 1422805B06, 1422805B07, 1422805B08, 1422807B00, 1422807B01, 1422807B02, 1422807B03, 1422807B04, 1422831-00, 1422832-00, 1422833-00, 1422834-00, 1422902-00, 1422902-01, 1422902-02, 1422902-03, 1422902-04, 1422908-00, 1422910-00, 1423901-00, 1423901-01, 1423901-02, 1423902-00, 1423902-01, 1423902-02, 1423903-00, 1423903-01, 1423903-02, 2022801-02, 2022801-03, 2022801A02, 2022801A03, 2022801B02, 2022801B03, 2022801C02, 2022801C03, 2022802-02, 2022802-03... (Other models you can see in the webshop)		
<b>accessories for</b>	415568		
	<b>Part No.</b>	375044	<b>Ref. No.</b> 203185
	safety thermostat switch-off temp. 178°C 1-pole 16A probe ø 4mm probe L 91mm capillary pipe 1730mm capillary pipe isolated 1600mm gland nut probe with sealing sleeve screw connection M8x1 sealing sleeve 8.6x32mm		



1 1/2"			
			
<b>Part No.</b>	415402	<b>Ref. No.</b>	537081 573075
<b>description</b>	heating element 6000W 400/230V heating circuits 3 thread 1 1/2" L 425mm W 35mm H 35mm thermostat sleeves ø 7mm length thermostat sleeves 330mm thermostat sleeve centre not clinging tube ø 8.5mm connection M4 immersion heater flange with thread WS 60 no original spare part number of thermostat sleeves 1		
<b>For models:</b>	14228011-0, 14228022-0, 14228033-0, 14228044-0, 14228055-0, 2022801-00, 2022801-01, 20228011-0, 20228011-1, 2022801A00, 2022801A01, 2022801B00, 2022801B01, 2022801C00, 2022801C01, 2022802-00, 2022802-01, 20228022-0, 20228022-1, 2022802A00, 2022802A01, 2022802B00, 2022802B01, 2022802C00, 2022802C01, 2022803-00, 2022803-01, 20228033-0, 20228033-1, 2022803A00, 2022803A01, 2022803B00, 2022803B01, 2022803C00, 2022803C01, 2022804-00, 2022804-01, 20228044-0, 20228044-1, 2022804A00, 2022804A01, 2022804B00, 2022804B01, 2022804C00, 2022804C01, 2022805-00, 2022805-01, 20228055-0, 20228055-1, 2022805A00... (Other models you can see in the webshop)		
<b>spare parts for</b>	415402		
	<b>Part No.</b>	510406	<b>Ref. No.</b> —
	flat gasket fibre ED ø 60mm ID ø 48mm thickness 3mm for thread 1 1/2" Qty 1 pcs		
<b>accessories for</b>	415402		
	<b>Part No.</b>	510424	<b>Ref. No.</b> —
	gasket copper ED ø 55mm ID ø 48mm thickness 2.2mm Centellen for thread 1 1/2"		
	<b>Part No.</b>	520211	<b>Ref. No.</b> —
	reducer thread 2" ET - 1 1/2" IT brass		
	<b>Part No.</b>	520212	<b>Ref. No.</b> —
	hexagonal nut thread 1 1/2" brass WS 60 H 8mm		
	<b>Part No.</b>	550361	<b>Ref. No.</b> —
	blind flange ø 58mm thread 1 1/2"		





## heating elements for convection



			
1			
<b>Part No.</b>	419248	<b>Ref. No.</b>	574183
<b>description</b>	heating element 15300W 440V heating circuits 6 ID $\varnothing$ 450mm ED $\varnothing$ 530mm L 540mm H 113mm W1 96mm H1 23mm H2 90mm flange length 130mm flange width 70mm connection length 100mm tube $\varnothing$ 6.5mm cable length 1200mm dry heating element with fixing flange		

			
1			
<b>Part No.</b>	418750	<b>Ref. No.</b>	574177
<b>description</b>	heating element 15400W 400V heating circuits 6 ID $\varnothing$ 450mm ED $\varnothing$ 530mm L 540mm H 113mm W1 96mm H1 23mm H2 90mm flange length 130mm flange width 70mm connection length 100mm tube $\varnothing$ 6.5mm cable length 1200mm dry heating element with fixing flange		
<b>For models:</b>	CGE11-L, CGE11-R, CGE12-L, CGE12-R, CGE21-L, CGE21-R, CGE61-L, CGE61-R, CSE11-L, CSE11-R, CSE11-R-DG, CSE21-L, CSE21-R, CSE21-R-DG, CSE61-L, CSE61-R, CSE61-R-DG, CSE62-L, CSE62-R, CSE62-R-DG		
<b>accessories for</b>	418750		
	<b>Part No.</b>	550639	<b>Ref. No.</b> 211083
gasket L 130mm W 70mm thickness 1mm for heating element			

			
1			
<b>Part No.</b>	418748	<b>Ref. No.</b>	574181
<b>description</b>	heating element 20400W 400V heating circuits 6 ID $\varnothing$ 450mm ED $\varnothing$ 525mm L 107mm H 113mm W1 97mm H1 28mm H2 85mm flange length 130mm flange width 70mm hole distance 119mm connection length 100mm tube $\varnothing$ 6.5mm cable length 1200mm dry heating element hole $\varnothing$ 6mm with fixing flange		
<b>For models:</b>	CGE12-L, CGE12-R, CGE62-L, CGE62-R, CSE62-L, CSE62-R		
<b>accessories for</b>	418748		
	<b>Part No.</b>	550639	<b>Ref. No.</b> 211083
gasket L 130mm W 70mm thickness 1mm for heating element			

			
1			
<b>Part No.</b>	418751	<b>Ref. No.</b>	574189
<b>description</b>	heating element 30000W 400V heating circuits 6 ID $\varnothing$ 380mm ED $\varnothing$ 450mm L 535mm H 120mm W1 99mm H1 20mm H2 100mm flange length 130mm flange width 70mm connection length 100mm tube $\varnothing$ 8mm cable length 1200mm dry heating element with fixing flange		
<b>For models:</b>	CGE11-L, CGE11-R, CGE12-L, CGE12-R, CGE22-L, CGE22-R, CGE62-L, CGE62-R, CSE12-L, CSE12-R, CSE12-R-DG, CSE22-L, CSE22-R, CSE22-R-DG		

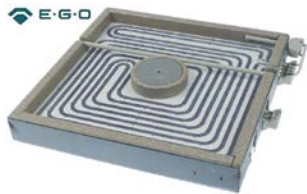
			
1			
<b>Part No.</b>	420336	<b>Ref. No.</b>	574160
<b>description</b>	heating element 9900W 230V heating circuits 3 ID $\varnothing$ 450mm ED $\varnothing$ 465mm L 500mm H 104mm L1 30mm W1 96mm H1 13mm H2 91mm flange length 130mm flange width 70mm hole distance 55/50mm connection M4 tube $\varnothing$ 6.3mm convection heating element hole $\varnothing$ 7mm flange connection		
<b>For models:</b>	CGE61-L, CGE61-R, CGE62-L, CGE62-R, CSE61-L, CSE61-R, CSE62-L, CSE62-R		

			
1			
<b>Part No.</b>	418749	<b>Ref. No.</b>	574176
<b>description</b>	heating element 9900W 400V heating circuits 3 ID $\varnothing$ 450mm ED $\varnothing$ 465mm L 500mm H 115mm L1 35mm W1 96mm H1 26mm H2 89mm flange length 130mm flange width 70mm connection length 100mm tube $\varnothing$ 6.5mm cable length 1200mm dry heating element with fixing flange		
<b>For models:</b>	CGE11-L, CGE11-R, CGE61-L, CGE61-R, CSE61-L, CSE61-R, CSE61-R-DG, CSE62-L, CSE62-R, CSE62-R-DG		
<b>accessories for</b>	418749		
	<b>Part No.</b>	550639	<b>Ref. No.</b> 211083
gasket L 130mm W 70mm thickness 1mm for heating element			



radiation heaters

square



1

<b>Part No.</b>	490009 <sup>1</sup>	<b>Ref. No.</b>	203037
<b>description</b>	radiation heater L 300mm W 300mm 4000W 400V connections 3+2 square with pan detection EGO		
<b>For models:</b>	0723405-01, 0723405-02, 0723409-01, 0723409-02, 0723413-02, 0723414-02, 1023410-00, 1423404-00, 1423404-01, 1423405-00, 1423405-01, 1423405-02, 1423409-00, 1423409-01, 1423409-02, 1423413-02, 1423414-02, 1424819-00, 1424826-00, 1523405-00, 1523405-01, 1523409-00, 1523409-01, 1523410-00, 2023206-00, 2023206-01, 2023206-02, 2023207-00, 2023207-01, 2023207-02, 2023207-03, 2023207-04, 2023207-05, 2023405-00, 2023405D00, 2023406-00, 2023407-00, 2023407-01, 2023409-00, 3023206-00, 3023206-01, 3023206-02, 3023405-00, 3023406-00, 3023409-00		
<b>spare parts for</b>	490009		
	<b>Part No.</b>	499157	<b>Ref. No.</b> —
	protection pipe for temperature probe ceramic L 297mm ED ø 7mm ID ø 5mm		

<sup>1</sup>with pan detection

1-circuit



1

<b>Part No.</b>	490093	<b>Ref. No.</b>	203047
<b>description</b>	radiation heater ø 230mm 2100W 230V		
<b>For models:</b>	1223202-00, 2123207-00, 2123208-00, 2123208-01		



1

<b>Part No.</b>	490043	<b>Ref. No.</b>	202799
<b>description</b>	radiation heater ø 230mm 2300W 230V heating circuits 1 H 32mm energy regulation with temperature signalization with ribbon heater connections 2+2 connection type male faston 6.3mm horizontal EGO		
<b>For models:</b>	1023401K00, 1223401K00, 1223401L00, 1223402K00, 1323401K00, 1323402K00, 1323403K00, 1423402K01, 1523401K00, 1523402-00, 1523402K00, 2123401K00, 2123402K00, 2123403K00		

hot plates

square & rectangular

with radiused edge



1

<b>Part No.</b>	490065	<b>Ref. No.</b>	203068
<b>description</b>	hot plate dimensions 220x220mm 2000W 230V with spill ring connection 4 screw clamps protector no square		



1

<b>Part No.</b>	490067	<b>Ref. No.</b>	203051 203076
<b>description</b>	hot plate dimensions 220x220mm 2000W 400V with spill ring connection 4 screw clamps protector no square		
<b>For models:</b>	0223202-00, 1223201-00, 1223207-00, 1323201-00, 1323207-00, 1323208-00, 1323208-01, 1323208-02, 1424802-00, 1424808-00, 1424808-01, 1424811-00, 1424811-01, 2123201-00, 2123201-01, 2123202-00, 2123202-01, 2123202A00, 2123202A01, 2123203-00, 2123203-01, 2123203-02, 2123203-03, 2123203-04, 2123203A00, 2123203A01, 2123203A02, 2123203A03, 2123203A04, 2123204-00, 2123204-01, 2123204-02, 2123204-03, 2123204-04, 2123204A00, 2123204A01, 2123204A02, 2123204A03, 2123204A04, 2123209-00		
<b>accessories for</b>	490067		
	<b>Part No.</b>	693464	<b>Ref. No.</b> 211047
	sealing cord ø 10mm Qty supplied by meter		



1

<b>Part No.</b>	490068 <sup>1</sup>	<b>Ref. No.</b>	203071
<b>description</b>	hot plate dimensions 220x220mm 2600W 400V with spill ring connection 4 screw clamps protector yes square		
<b>For models:</b>	1223201-01, 1223207-01, 1323201-01, 1323201-02, 1323207-02, 1323208-03, 1323208-04, 1424802-01, 1424802-02, 1424808-02, 1424808-03, 1424811-02, 1424811-03, 2123201-02, 2123201-03, 2123201-04, 2123202-02, 2123202-03, 2123203-05, 2123203-06, 2123203-07, 2123203-08, 2123204-05, 2123204-06, 2123204-07, 2123204-08, 2123209-01, 2123209-02		

<sup>1</sup>incl. protector




1

<b>Part No.</b>	490128 <sup>1</sup>	<b>Ref. No.</b>	203053 203065
<b>description</b>	hot plate dimensions 300x300mm 2500W 400V with spill ring connection 4 screw clamps protector yes square		
<b>For models:</b>	1424809-00, 1424809-01, 1424809-02, 14248099-0, 1424812-00, 1424812-01, 1424812-02, 1424813-00, 1424813-01, 1424813-02, 2023201-00, 2023201-01, 2023201-02, 2023201-03, 20232011-0, 20232011-1, 2023202-00, 2023202-01, 2023202-02, 20232022-0, 20232022-1, 2023203-00, 2023203-01, 2023203-02, 2023203-03, 2023203-04, 2023203-05, 2023203-06, 2023203-07, 20232033-0, 20232033-1, 2023204-00, 2023204-01, 2023204-02, 20232044-0, 20232044-1, 2023205-00, 2023205-01, 2023205-02, 2023205-03, 2023205-04, 2023205-05, 2023205-06, 2023205-07, 20232055-0, 20232055-1, 3023201-00, 3023201-01, 3023201-02, 3023202-00... (Other models you can see in the webshop)		


<sup>1</sup>incl. protector



1

<b>Part No.</b>	490071 <sup>1</sup>	<b>Ref. No.</b>	203776
<b>description</b>	hot plate dimensions 300x300mm 4000W 230V with spill ring connection 4 screw clamps protector yes square		

<sup>1</sup>incl. protector



1

<b>Part No.</b>	490074 <sup>1</sup>	<b>Ref. No.</b>	203054
<b>description</b>	hot plate dimensions 300x300mm 4000W 400V with spill ring connection 4 screw clamps protector yes square		
<b>For models:</b>	1424809-00, 1424809-01, 1424809-02, 14248099-0, 1424812-00, 1424812-01, 1424812-02, 1424813-00, 1424813-01, 1424813-02, 2023201-00, 2023201-01, 2023201-02, 2023201-03, 20232011-0, 20232011-1, 2023201A00, 2023201A01, 2023202-00, 2023202-01, 2023202-02, 20232022-0, 20232022-1, 2023202A00, 2023202A01, 2023203-00, 2023203-01, 2023203-02, 2023203-03, 2023203-04, 2023203-05, 2023203-06, 2023203-07, 20232033-0, 20232033-1, 2023203A00, 2023203A01, 2023203A02, 2023203A03, 2023204-00, 2023204-01, 2023204-02, 20232044-0, 20232044-1, 2023204A00, 2023204A01, 2023205-00, 2023205-01, 2023205-02, 2023205-03... (Other models you can see in the webshop)		

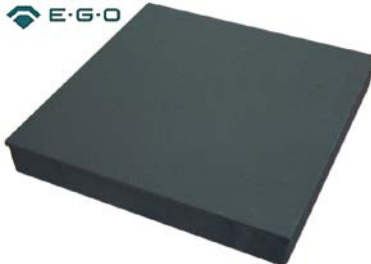
<sup>1</sup>incl. protector

### tiltable



1

<b>Part No.</b>	490088	<b>Ref. No.</b>	203075
<b>description</b>	hot plate dimensions 300x300mm 2500W 400V with cast edge tilt boiling plate connection 4 screw clamps H 43mm square		
<b>For models:</b>	2023302-00, 2023303-00, 2023304-00, 2023305-00		




1

<b>Part No.</b>	490090	<b>Ref. No.</b>	203108
<b>description</b>	hot plate dimensions 300x300mm 4000W 400V with cast edge tilt boiling plate connection 4 screw clamps H 43mm square		
<b>For models:</b>	2023302-00, 2023303-00, 2023304-00, 2023305-00		

## round


### with radiused edge

#### for domestic and commercial kitchens



1

<b>Part No.</b>	490011	<b>Ref. No.</b>	203073
<b>description</b>	hot plate ø 145mm 1000W 400V connection 4 screw clamps with 8mm spill ring		
<b>For models:</b>	0520901-00		





1

<b>Part No.</b>	490014	<b>Ref. No.</b>	203064
<b>description</b>	hot plate ø 180mm 1500W 230V connection 4 screw clamps with 8mm spill ring		






			
1			
<b>Part No.</b>	490015	<b>Ref. No.</b>	203058
<b>description</b>	hot plate ø 180mm 1500W 400V connection 4 screw clamps with 8mm spill ring		

			
1			
<b>Part No.</b>	490017	<b>Ref. No.</b>	203062
<b>description</b>	hot plate ø 180mm 2000W 400V connection 4 screw clamps with 8mm spill ring		


			
1			
<b>Part No.</b>	490018	<b>Ref. No.</b>	203066
<b>description</b>	hot plate ø 220mm 2000W 230V connection 4 screw clamps with 8mm spill ring		
<b>For models:</b>	1424816-00		


			
1			
<b>Part No.</b>	490019	<b>Ref. No.</b>	203059
<b>description</b>	hot plate ø 220mm 2000W 400V connection 4 screw clamps with 8mm spill ring		

## energy regulators

### EGO

#### 1-circuit


			
1			
<b>Part No.</b>	380015	<b>Ref. No.</b>	203160
<b>description</b>	energy regulator 230V 13A single-circuit turn direction right shaft ø 6x4.6mm shaft L 23mm mounting thread M4 power release 6-100% no. 50.57021.010		
<b>For models:</b>	00217022-0, 0221001H00, 0221202-00, 0221501-00, 0221502-00, 0521701-00, 0521701-01, 0521702-00, 0521702-01, 0521702-02, 0521702-03, 0521702-04, 0521702B03, 0521702B04, 0521702C04, 0521704-04, 0521704-05, 0521704-06, 0521704-07, 0521705-00, 0521705-01, 1022603-00, 1023401-00, 1023401K00, 1220402-00, 1220402-01, 1221501-00, 1221501-01, 1221501-02, 1222603-00, 1223202A00, 1223202A01, 1223202J00, 1223202J01, 1223209-00, 1223209-01, 1223401-00, 1223401J00, 1223401K00, 1223401L00, 1223402-00, 1223402K00, 1320402-00, 1320402-01, 1321501-00, 1321501-01, 1321501-02, 1321501-03, 1322603-00, 1323202A00... (Other models you can see in the webshop)		

			
1			
<b>Part No.</b>	380013	<b>Ref. No.</b>	203161
<b>description</b>	energy regulator 400V 7A single-circuit turn direction right shaft ø 6x4.6mm mounting thread M4 no. 50.57031.010		
<b>For models:</b>	0521702A02, 0521702A03, 0521702A04, 0723412K01, 1423412K01		


## thermostats

### bi-metal thermostats

#### safety bi-metal thermostats


			
1			
<b>Part No.</b>	378659	<b>Ref. No.</b>	202806
<b>description</b>	bi-metal safety thermostat hole distance 24mm switch-off temp. 320°C NC 1-pole 16A 400V connection with cable cable length 120mm with fixing sheet		
<b>For models:</b>	CGE11-L, CGE11-R, CGE12-L, CGE12-R, CGE21-L, CGE21-R, CGE22-L, CGE22-R, CGG11-L, CGG11-R, CGG12-L, CGG12-R, CGG21-L, CGG21-R, CGG22-L, CGG22-R, CSE11-L, CSE11-R, CSE11-R-DG, CSE12-L, CSE12-R, CSE12-R-DG, CSE21-L, CSE21-R, CSE21-R-DG, CSE22-L, CSE22-R, CSE22-R-DG, CSE61-L, CSE61-R, CSE61-R-DG, CSG11-L, CSG11-R, CSG11-R-DG, CSG12-L, CSG12-R, CSG12-R-DG, CSG21-L, CSG21-R, CSG21-R-DG, CSG22-L, CSG22-R, CSG22-R-DG		

#### bi-metal thermostats

			
1			
<b>Part No.</b>	390160	<b>Ref. No.</b>	203255
<b>description</b>	bi-metal thermostat hole distance 30mm switch-off temp. 90°C 1NO 1-pole 10A connection F6.3		
<b>For models:</b>	1422802B04, 1422802B05, 1422802B06, 1422802B07, 1422802B08, 1422804B04, 1422804B05, 1422804B06, 1422804B07, 1422804B08, 1422805B04, 1422805B05, 1422805B06, 1422805B07, 1422805B08, 1422807B00, 1422807B01, 1422807B02, 1422807B03, 1422807B04, 1422831-00, 1422832-00, 1422833-00, 1422834-00, 1422902-00, 1422902-01, 1422902-02, 1422902-03, 1422902-04, 1422908-00, 1422910-00, 1462802B00, 1462802B01, 1462802B02, 1462802B03, 1462802B04, 1462802B05, 1462804B00, 1462804B01, 1462804B02, 1462804B03, 1462804B04, 1462804B05, 1462831-00, 1462832-00, 1462833-00, 1462834-00, 1462835-00, 1462836-00, 1462837-00... (Other models you can see in the webshop)		






			
1			
<b>Part No.</b>	390767	<b>Ref. No.</b>	203523
<b>description</b>	bi-metal thermostat switch-off temp. 60°C 1NC 1-pole connection F6.3		
<b>For models:</b>	0723104B03, 0723105B03, 0723405-01, 0723405-02, 0723409-02, 0723412K01, 0723413-02, 0723414-02, 1412833-00, 1412833-01, 1412834-00, 1412834-01, 1412910-00, 1412910-01, 1422701-01, 1422701-02, 1422701-03, 1422702-01, 1422702-02, 1422702-03, 1422703-00, 1422703-01, 1422703-02, 1422704-00, 1422704-01, 1422704-02, 1422705-00, 1422705-01, 1422705-02, 1422706-00, 1422706-01, 1422706-02, 1422707-00, 1422707-01, 1422707-02, 1422708-00, 1422708-01, 1422708-02, 1423104B03, 1423105B03, 1423402-00, 1423402K01, 1423405-00, 1423405-01, 1423405-02, 1423409-02, 1423412K01, 1423413-02, 1423414-02, 1423502-00... (Other models you can see in the webshop)		

## control and safety thermostats


EGO


control thermostats

55.10/19\_ series

			
1			
<b>Part No.</b>	375001	<b>Ref. No.</b>	203498
<b>description</b>	thermostat t.max. 112°C temperature range 30-110°C 1-pole 1NO 16A probe ø 6mm probe L 130mm capillary pipe 900mm capillary pipe isolated gland nut M9x1 shaft L 23mm shaft position upper rotation 270°		
<b>For models:</b>	1224002-00, 1224002-01, 1224003-00, 1224003-01, 1224004-00, 1224004-01, 1224005-00, 1224005-01, 1224006-00, 1224006-01, 1224007-00, 1224007-01, 1224008-00, 1224008-01, 1224009-00, 1224009-01		

55.13\_ series

			
1			
<b>Part No.</b>	390161	<b>Ref. No.</b>	203167
<b>description</b>	thermostat t.max. 114°C temperature range 36-114°C 1-pole 1NO 16A probe ø 31/36mm probe Lmm capillary pipe 870mm capillary pipe isolated 800mm gland nut shaft ø 6x4.6mm shaft L 23mm shaft position upper rotation 270° with knob probe (boiling plate)		
<b>For models:</b>	1422802B04, 1422802B05, 1422802B06, 1422802B07, 1422802B08, 1422804B04, 1422804B05, 1422804B06, 1422804B07, 1422804B08, 1422805B04, 1422805B05, 1422805B06, 1422805B07, 1422805B08, 1422807B00, 1422807B01, 1422807B02, 1422807B03, 1422807B04, 1422831-00, 1422832-00, 1422902-00, 1422902-01, 1422902-02, 1422902-03, 1422902-04, 1422908-00, 1462802B00, 1462802B01, 1462802B02, 1462802B03, 1462802B04, 1462802B05, 1462804B00, 1462804B01, 1462804B02, 1462804B03, 1462804B04, 1462804B05, 1462831-00, 1462832-00, 1462835-00, 1462836-00, 1462837-00, 1462908-00, 2022801-01, 2022801-02, 2022801-03, 2022801A01... (Other models you can see in the webshop)		

			
1			
<b>Part No.</b>	375760	<b>Ref. No.</b>	203490
<b>description</b>	thermostat t.max. 116°C temperature range 36-116°C 1-pole 1NO 16A probe ø 6mm probe L 113mm capillary pipe 870mm capillary pipe isolated 350mm gland nut M9x1 shaft ø 6x4.6mm shaft L 23mm shaft position upper rotation 270°		
<b>For models:</b>	0720504-04, 1020510-00, 1120510-00, 1120510-01, 1220501-00, 1220501-01, 1220501-02, 1220502-00, 1220502-01, 1220503-00, 1220504-01, 1220802-00, 1220802-01, 1222601-00, 1320501-00, 1320501A00, 1320501A01, 1320502-00, 1320502A00, 1320502A01, 1320504-01, 1320504-02, 1320802-00, 1320802A00, 1322601-00, 1420501-00, 1420501-01, 1420501-02, 1420501-03, 1420502-00, 1420502-01, 1420502-02, 1420504-00, 1420504-01, 1420504-02, 1420504-03, 1420504-04, 1420505-00, 1420505-01, 1420505-02, 1420509-01, 1420801-01, 1420803-01, 1422601-00, 1422602-00, 1520501-00, 1820501-00, 1820801-0, 2020501-01, 2020501-02... (Other models you can see in the webshop)		




<b>Part No.</b>	375952	<b>Ref. No.</b>	203760
<b>description</b>	thermostat t.max. 150°C temperature range 30-150°C 1-pole 1NO 16A probe ø 6mm probe L 84mm capillary pipe 850mm capillary pipe isolatedmm gland nut shaft ø 6x4.6mm shaft L 23mm shaft position upper rotation 270° 380V		
<b>For models:</b>	1022603-00, 1220402-00, 1220402-01, 1222603-00, 1320402-00, 1320402-01, 1322603-00, 1420402-00, 1420402-01, 1420405-00, 1520402-00, 1520402-01, 1520403-00, 1520403-01, 1522603-00, 1522603-01, 2020402-00, 2020402-01, 2022603-00, 2120402-00, 2120402-01, 2420403-00, 2420403-01, 3020402-00, 3020402-01		



<b>Part No.</b>	375193	<b>Ref. No.</b>	203248
<b>description</b>	thermostat t.max. 300°C temperature range 50-300°C 1-pole 1NO 16A probe ø 4mm probe L 91mm capillary pipe 1130mm capillary pipe isolated 1100mm gland nut shaft L 23mm shaft position upper rotation 270°		
<b>For models:</b>	0021130A00, 0021130A01, 0021135A00, 0522101-02, 0522102-02, 0721134-01, 0721134A01, 0721172A01, 0721173A01, 0721174A01, 0721175A01, 1121117-00, 1121117-01, 1121117A00, 1121118-00, 1121118-01, 1121119-00, 1121119A00, 1121120-00, 1121121-00, 1121121A00, 1121135A01, 1221103-04, 1221103B04, 1221105-00, 1221105-01, 1221105-02, 1221105A00, 1221105A01, 1221105A02, 1221105B00, 1221105B01, 1221105B02, 1221106-00, 1221106-01, 1221106A00, 1221106A01, 1221106B00, 1221106B01, 1221107-00, 1221107-01, 1221107-02, 1221108-00, 1221108-01, 1221108-02, 1221109-00, 1221109-01, 1221110-00, 1221110-01, 1221111-00... (Other models you can see in the webshop)		



<b>Part No.</b>	375401	<b>Ref. No.</b>	203662
<b>description</b>	thermostat t.max. 185°C temperature range 97-185°C 1-pole 1NO 16A probe ø 6mm probe L 87mm capillary pipe 1430mm capillary pipe isolated 1100mm gland nut M9x1 shaft ø 6x4.6mm shaft L 23mm shaft position upper rotation 270°		



<b>Part No.</b>	375505	<b>Ref. No.</b>	203177 203500
<b>description</b>	thermostat t.max. 320°C temperature range 50-320°C 1-pole 1NO 16A probe ø 3mm probe L 160mm capillary pipe 870mm capillary pipe isolatedmm gland nut shaft ø 6x4.6mm shaft L 23mm shaft position upper rotation 270°		
<b>For models:</b>	1424816-00, 1821101-00		



<b>Part No.</b>	375747	<b>Ref. No.</b>	203067 203662
<b>description</b>	thermostat t.max. 190°C temperature range 97-190°C 1-pole 1NO 16A probe ø 6mm probe L 87mm capillary pipe 1430mm capillary pipe isolated 1100mm gland nut M9x1 shaft ø 6x4.6mm shaft L 23mm shaft position upper rotation 270°		
<b>For models:</b>	0520303-02, 0720325-03, 0720325-04, 0720325B03, 0720325B04, 1220301-00, 1220301-01, 1220301-02, 1220301-03, 1220301-04, 1220301B00, 1220301B01, 1220301B02, 1220301B03, 1220301B04, 1220301D00, 1220301D01, 1220301E00, 1220301E01, 1220301J00, 1220301J01, 1220301J02, 1220301J03, 1220303-00, 1220303-01, 1220303-02, 1220303-03, 1220303-04, 1220303-05, 1220303A00, 1220303A01, 1220303A02, 1220303A03, 1220303B00, 1220303B01, 1220303B02, 1220303B03, 1220303B04, 1220303B05, 1220303C00, 1220303C01, 1220303C02, 1220303C03, 1220303D00, 1220303D01, 1220303D02, 1220303E00, 1220303E01, 1220303E02, 1220303F01... (Other models you can see in the webshop)		

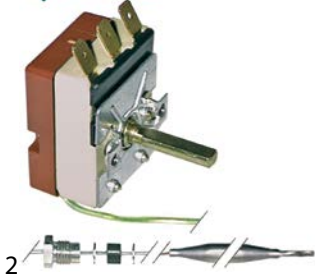


E-G-O



<b>Part No.</b>	375717	<b>Ref. No.</b>	203176
<b>description</b>	thermostat t.max. 82°C temperature range fixed 40°C 1NO 16A probe ø 3mm probe L 156mm capillary pipe 600mm capillary pipe isolated 600mm gland nut shaft ø 6x4.6mm shaft L 8.5mm shaft position right° rotation 180° outer switch eccentric 1/2"-3/4"		
<b>For models:</b>	1223209-00, 1223209-01, 1223402-00, 1223402K00, 1323209-00, 1323209-01, 1323209-02, 1323209-03, 1323210-00, 1323210-01, 1323210-02, 1323210-03, 1323210-04, 1323402-00, 1323402K00, 1323403-00, 1323403K00, 2023206-00, 2023206-01, 2023207-00, 2023207-01, 2023207-02, 2023207-03, 2023207-04, 2023503-04, 2023503-05, 2023503-06, 2023503-07, 2023503-08, 2023503-09, 2023503-10, 2023503A04, 2023503A05, 2023503A06, 2023503A07, 2023503A08, 2023503A09, 2023503A10, 2123207A00, 2123208A00, 2123208A01, 2123208A02, 2123503-01, 2123503-02, 2123503-03, 2123503-04, 2123503-05, 2123503-06, 2123503A01, 2123503A03... (Other models you can see in the webshop)		

E-G-O



<b>Part No.</b>	375400	<b>Ref. No.</b>	203173
<b>description</b>	thermostat t.max. 90°C temperature range 30-90°C 1-pole 1CO 16A probe ø 6mm probe L 98mm capillary pipe 2380mm capillary pipe isolated 1700mm gland nut M9x1 shaft ø 6x4.6mm shaft L 18mm shaft position upper rotation 270°		

E-G-O



<b>Part No.</b>	390036	<b>Ref. No.</b>	203173
<b>description</b>	thermostat t.max. 90°C temperature range 30-90°C 1-pole capillary pipe isolated gland nut		
<b>For models:</b>	20628022-0, 20628022-1, 20628033-0, 20628044-0, 20629011-0, 20629022-0		

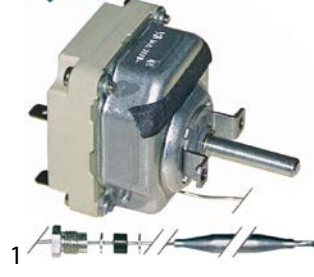
55.34\_series

E-G-O



<b>Part No.</b>	375021	<b>Ref. No.</b>	203486
<b>description</b>	thermostat t.max. 110°C temperature range 32-110°C 3-pole 3CO 16A probe ø 6mm probe L 138mm capillary pipe 2980mm capillary pipe isolated 2200mm gland nut M9x1 shaft ø 6x4.6mm shaft L 23mm shaft position upper rotation 270°		
<b>For models:</b>	14228011-0, 14228022-0, 14228033-0, 14228044-0, 14228055-0, 2022801-00, 20228011-0, 20228011-1, 2022801A00, 2022801B00, 2022801C00, 2022802-00, 20228022-0, 20228022-1, 2022802A00, 2022802C00, 2022803-00, 20228033-0, 20228033-1, 2022803A00, 2022803B00, 2022803C00, 2022804-00, 20228044-0, 20228044-1, 2022804A00, 2022804B00, 2022804C00, 2022805-00, 20228055-0, 20228055-1, 2022805A00, 2022805B00, 2022805C00, 2022806-00, 20228066-0, 20228066-1, 2022806A00, 2022806B00, 2022806C00, 2022807-00, 20228077-0, 20228077-1, 2022807A00, 2022807B00, 2022807C00, 2022901-00, 20229011-0, 20229011-1, 2022901A00... (Other models you can see in the webshop)		

E-G-O




<b>Part No.</b>	375143	<b>Ref. No.</b>	203491
<b>description</b>	thermostat t.max. 110°C temperature range 32-110°C 3-pole 3NO 16A probe ø 6mm probe L 138mm capillary pipe 1480mm capillary pipe isolated 1100mm gland nut M9x1 shaft ø 6x4.6mm shaft L 23mm shaft position upper rotation 270°		
<b>For models:</b>	0220501-00, 0220502-00, 0220503-00, 0220802-00, 0520901-00, 1420801-00, 1420803-00, 2020501-00, 20205011-0, 2020502-00, 20205033-0, 2020504-00, 2120501-00, 2120502-00, 3020502-00		




<b>Part No.</b>	375735	<b>Ref. No.</b>	203661
<b>description</b>	thermostat t.max. 180°C temperature range 100-180°C 3-pole 3NO 16A probe ø 6mm probe L 133mm capillary pipe 2300mm capillary pipe isolated 450mm gland nut M9x1 shaft ø 6x4.6mm shaft L 23mm shaft position upper rotation 270°		
<b>For models:</b>	0520303-02, 0720332R00, 0720332V00, 1420332P01, 1420332P02, 1420332P03, 1420332R00, 1420332R01, 1420332R02, 1420332R03, 1420332T01, 1420332T02, 1420332T03, 1420332V01, 1420332V02, 1420332V03, 1420333P01, 1420333P02, 1420333R00, 1420333R01, 1420333R02, 1420333T01, 1420333T02, 1420333V01, 1420333V02, 1420334P00, 1420334P01, 1420334P02, 1420334P03, 1420334P04, 1420334R02, 1420334R03, 1420334R04, 1420334T02, 1420334T03, 1420334T04, 1420334V01, 1420334V02, 1420334V03, 1420334V04, 1420334W02, 1420334W03, 1420334W04, 1420334Y02, 1420334Y03, 1420334Y04, 1420344R00, 1420344R01, 1420344R02, 1520332P00... (Other models you can see in the webshop)		



<b>Part No.</b>	375097	<b>Ref. No.</b>	203497
<b>description</b>	thermostat t.max. 195°C temperature range 95-195°C 3-pole 3NO 16A probe ø 6mm probe L 117mm capillary pipe 1780mm capillary pipe isolated 1400mm gland nut M9x1 shaft ø 6x4.6mm shaft L 23mm shaft position upper rotation 270°		



<b>Part No.</b>	375504	<b>Ref. No.</b>	203499
<b>description</b>	thermostat t.max. 220°C temperature range 95-220°C 3-pole 3NO 16A probe ø 6mm probe L 117mm capillary pipe 1480mm capillary pipe isolated 1100mm gland nut shaft ø 6x4.6mm shaft L 23mm shaft position upper rotation 270°		



<b>Part No.</b>	375022	<b>Ref. No.</b>	200496
<b>description</b>	thermostat t.max. 180°C temperature range 95-180°C 3-pole 3NO 16A probe ø 6mm probe L 133mm capillary pipe 1780mm capillary pipe isolated 1400mm gland nut M9x1 shaft ø 6x4.6mm shaft L 23mm rotation 270°		



<b>Part No.</b>	375025	<b>Ref. No.</b>	203488
<b>description</b>	thermostat t.max. 300°C temperature range 50-300°C 3-pole 3CO 16A probe ø 6mm probe L 77mm capillary pipe 2980mm capillary pipe isolated 2260mm gland nut shaft ø 6x4.6mm shaft L 23mm shaft position upper rotation 270°		

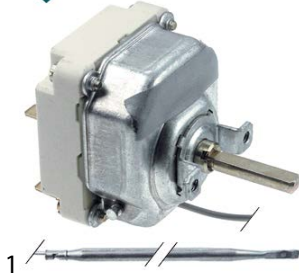


<b>Part No.</b>	375512	<b>Ref. No.</b>	203487 203496
<b>description</b>	thermostat t.max. 185°C temperature range 95-185°C 3-pole 3NO 16A probe ø 6mm probe L 133mm capillary pipe 2430mm capillary pipe isolated 1100mm gland nut M9x1 shaft ø 6x4.6mm shaft L 23mm shaft position upper rotation 270°		
<b>For models:</b>	0120101-00, 0120101C00, 0120105-00, 0120105C00, 0220301-00, 0220301B00, 0220301B01, 0220301B02, 0220301D00, 0220302-00, 0220302A00, 0220302A01, 0220302A02, 0220302A03, 0220302B00, 0220302B01, 0220302B02, 0220302C00, 0220302C01, 0220302C02, 0220302C03, 0220302D00, 0220302E00, 0220302E01, 0220302F00, 0220302H00, 0220302H01, 0220303-00, 0220303-01, 0220303A00, 0220303A01, 0220303A02, 0220303A03, 0220303B00, 0220303B01, 0220303C00, 0220303C01, 0220303C02, 0220303D00, 0220303D01, 0220303E00, 0220303E01, 0220303H00, 0220303H01, 0220304-00, 0220305-00, 0220306-00, 0520302-00, 0520303-00, 0520303-01... (Other models you can see in the webshop)		

<b>For models:</b>	2021401-00, 2021401-01, 2021401-02, 2021401-03, 2021401-04, 2021401-05, 2021401-06, 2021401-07, 2021401-08, 2021401-09, 2021401A00, 2021401A01, 2021401A02, 2021401A03, 2021401A04, 2021401A06, 2021401A07, 2021401A08, 2021401A09, 2021401B00, 2021401B01, 2021401B02, 2021401B03, 2021401B04, 2021401B06, 2021401B07, 2021401B08, 2021401B09, 2021401C00, 2021401C01, 2021401C02, 2021401C03, 2021401C04, 2021401C06, 2021401C07, 2021401C08, 2021401C09, 2021402-00, 2021402-01, 2021402-02, 2021402-03, 2021402-04, 2021402-05, 2021402-06, 2021402-07, 2021402-08, 2021402A00, 2021402A01, 2021402A02, 2021402A03... (Other models you can see in the webshop)		
--------------------	---	--	--

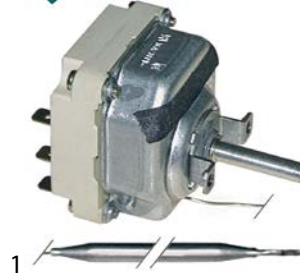


E-G-O



<b>Part No.</b>	375390	<b>Ref. No.</b>	203565
<b>description</b>	thermostat t.max. 300°C temperature range 50-300°C 3-pole 3NO 16A probe ø 4mm probe L 292mm capillary pipe 880mm capillary pipe isolated 800mm gland nut shaft ø 6x4.6mm shaft L 23mm shaft position upper		
<b>For models:</b>	0522101-04, 0522102-04, 0722101-06, 1323208-04, 1323210-03, 1323210-04, 1323403-00, 1323403K00, 1323506-00, 1323506-01, 1323506A00, 1323506A01, 1323517-00, 1323517A00, 1363403-03, 1363403-04, 1363403-05, 1363415-05, 1422101-04, 1422101-05, 1422101-06, 1422102-04, 1422102-05, 1422104-05, 1422105-05, 1422106-05, 1422106-06, 1422107-05, 1422107-06, 1422301-01, 2023114-00, 2023118-00, 2023119-00, 2023203-07, 2023205-07, 2023207-03, 2023207-04, 2023207-05, 2023406-00, 2023503-10, 2023503-11, 2023503-12, 2023503-13, 2023503A10, 2023503A11, 2023503A12, 2023503A13, 2023512A00, 2063403-08, 2063403-09... (Other models you can see in the webshop)		

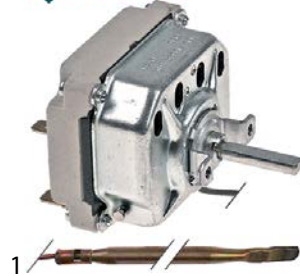
E-G-O



<b>Part No.</b>	375026	<b>Ref. No.</b>	203406
<b>description</b>	thermostat t.max. 350°C temperature range 100-350°C 3-pole 3NO 16A probe ø 6mm probe L 77mm capillary pipe 2430mm capillary pipe isolated 1100mm gland nut shaft ø 6x4.6mm shaft L 23mm shaft position upper rotation 270°		
<b>For models:</b>	2023501-00, 2023501A00, 2023502-00, 2023502A00, 2023503-00, 2023503A00, 2083501B00, 2083501C00, 2083502B00, 2083502C00		

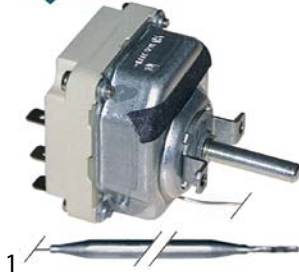
## 55.40\_ series

E-G-O



<b>Part No.</b>	375096	<b>Ref. No.</b>	203407
<b>description</b>	thermostat t.max. 450°C temperature range 100-450°C 4-pole 4NO 16A probe ø 3.9mm probe L 163mm capillary pipe 1180mm capillary pipe isolated 850mm gland nut shaft ø 6x4.6mm shaft L 23mm shaft position upper rotation 270°		
<b>For models:</b>	1223215-00, 1223215A00, 1223216-00, 1223216A00, 1223504A00, 1223504A01, 1223505-00, 1223505-01, 1223505A00, 1223505A01, 1323504-00, 1323504-01, 1323504A00, 1323504A01, 1323505-00, 1323505-01, 1323505A00, 1323505A01, 1323506-00, 1323506-01, 1323506A00, 1323506A01, 1323515-00, 1323515A00, 1323516-00, 1323516A00, 1323517-00, 1323517A00, 1423501-00, 1423501-01, 1423501A00, 1423501A01, 1423502-00, 1423502-01, 1423502-02, 1423502A00, 1423502A01, 1423502A02, 1423504-00, 1423504-01, 1423504A00, 1423504A01, 1423505-00, 1423505-01, 1423505A00, 1423505A01, 1423507A00, 1423508A00, 1423524A00, 1423525A00... (Other models you can see in the webshop)		

E-G-O



<b>Part No.</b>	375038	<b>Ref. No.</b>	203494
<b>description</b>	thermostat t.max. 300°C temperature range 50-300°C 3-pole 3NO 16A probe ø 6mm probe L 79mm capillary pipe 1740mm capillary pipe isolated 800mm gland nut shaft ø 6x4.6mm shaft L 23mm shaft position upper rotation 270°		
<b>For models:</b>	0221101-00, 0221101-01, 0221101A00, 0221101A01, 0221102-00, 0221102-01, 0221103-00, 0221103-01, 0221104-00, 0221104-01, 0221104A00, 0221104A01, 0221105-00, 0221105-01, 0221106-00, 0221106-01, 0221107-00, 0221107A00, 0221108-00, 0221109-00, 0221109A00, 0221110-00, 0522101-00, 0522101-01, 0522101-03, 0522102-00, 0522102-01, 0522102-03, 1221101-00, 1221101A00, 1221101B00, 1221102-00, 1221102A00, 1221102B00, 1221103-00, 1221103-01, 1221103-02, 1221103A00, 1221103A01, 1221103A02, 1221103B00, 1221103B01, 1221103B02, 1221103J00, 1221103J01, 1221104-00, 1221104-01, 1221104A00, 1221104A01, 1221104B00... (Other models you can see in the webshop)		

accessories for 375038



<b>Part No.</b>	110123	<b>Ref. No.</b>	—
knob thermostat t.max. 300°C ø 50mm shaft ø 6x4.6mm shaft flat upper black temperature range 50-300°C rotation 270°			





safety thermostats

51.\_series



<b>Part No.</b>	375518	<b>Ref. No.</b>	203479
<b>description</b>	safety thermostat switch-off temp. 213°C 1-pole 0.5A probe ø 6mm probe L 119mm capillary pipe 890mm capillary pipe isolatedmm gland nut probe SS		
<b>For models:</b>	0260301-00, 0260301-01, 0260302-00, 0260302-01, 1260301-00, 1260301-01, 1260302-00, 1260302-01, 1460302-00, 1460302-01, 1460302-02, 2060301-00, 2060301-01, 2060301-02, 20628022-2, 20628033-1, 20628033-2, 20628044-1, 20628044-2, 20629011-1, 20629011-2, 20629022-1, 20629022-2		

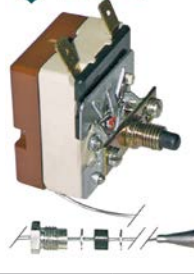
55.13.\_series



<b>Part No.</b>	375519	<b>Ref. No.</b>	203480
<b>description</b>	safety thermostat switch-off temp. 130°C 1-pole 1NO 16A probe ø 6mm probe L 129mm capillary pipe 830mm capillary pipe isolatedmm gland nut mounting thread M8x1 probe SS		
<b>For models:</b>	1462802B00, 1462802B01, 1462802B02, 1462802B03, 1462802B04, 1462802B05, 1462804B00, 1462804B01, 1462804B02, 1462804B03, 1462804B04, 1462804B05, 1462831-00, 1462832-00, 1462833-00, 1462834-00, 1462835-00, 1462836-00, 1462837-00, 1462838-00, 1462839-00, 1462840-00, 1462908-00, 1462910-00, 2062801-00, 2062801-01, 2062801-02, 2062801-03, 2062801-04, 2062801-05, 2062801-06, 2062801A00, 2062801A01, 2062801A02, 2062801A03, 2062801A04, 2062801A05, 2062801A06, 2062801B00, 2062801B01, 2062801B02, 2062801B03, 2062801B04, 2062801B05, 2062801B06, 2062801C00, 2062801C01, 2062801C02, 2062801C03, 2062801C04... (Other models you can see in the webshop)		
<b>accessories for</b>	375519		
	<b>Part No.</b>	102067	<b>Ref. No.</b> 201524
	nut thread M8x1 H 3mm brass Qty 1 pcs type SEF 1		



<b>Part No.</b>	375044	<b>Ref. No.</b>	203185
<b>description</b>	safety thermostat switch-off temp. 178°C 1-pole 16A probe ø 4mm probe L 91mm capillary pipe 1730mm capillary pipe isolated 1600mm gland nut probe with sealing sleeve screw connection M8x1 sealing sleeve 8.6x32mm		
<b>For models:</b>	1422802B04, 1422802B05, 1422802B06, 1422802B07, 1422802B08, 1422804B04, 1422804B05, 1422804B06, 1422804B07, 1422804B08, 1422805B04, 1422805B05, 1422805B06, 1422805B07, 1422805B08, 1422807B00, 1422807B01, 1422807B02, 1422807B03, 1422807B04, 1422831-00, 1422832-00, 1422833-00, 1422834-00, 1422902-00, 1422902-01, 1422902-02, 1422902-03, 1422902-04, 1422908-00, 1422910-00, 1423901-00, 1423901-01, 1423901-02, 1423902-00, 1423902-01, 1423902-02, 1423903-00, 1423903-01, 1423903-02, 2022801-02, 2022801-03, 2022801A02, 2022801A03, 2022801B02, 2022801B03, 2022801C02, 2022801C03, 2022802-02, 2022802-03... (Other models you can see in the webshop)		
<b>accessories for</b>	375044		
	<b>Part No.</b>	102067	<b>Ref. No.</b> 201524
	nut thread M8x1 H 3mm brass Qty 1 pcs type SEF 1		
	<b>Part No.</b>	551083	<b>Ref. No.</b> —
	cap for safety thermostat thread M8x1		

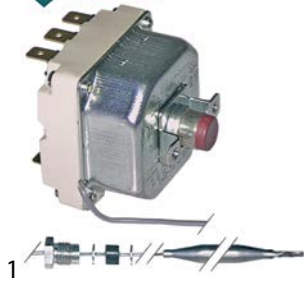


<b>Part No.</b>	390124	<b>Ref. No.</b>	203165 203492
<b>description</b>	safety thermostat switch-off temp. 246°C 1-pole 1NO 16A probe ø 6mm probe L 77mm capillary pipe 830mm capillary pipe isolatedmm gland nut M9x1 probe		
<b>For models:</b>	1220501-01, 1220802-00, 1220802-01, 1320501-00, 1320501A00, 1320802-00, 1320802A00, 1420801-01, 1420803-01, 1820301-00, 1820301-01, 1820301-02, 2120510-00, 2120510-01		



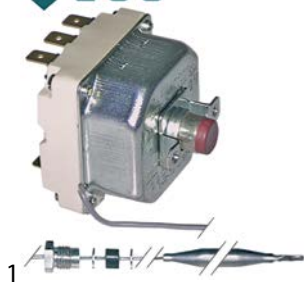
## 55.31\_series

E-G-O



<b>Part No.</b>	375524	<b>Ref. No.</b>	203493
<b>description</b>	safety thermostat switch-off temp. 135°C 3-pole 20A probe $\phi$ 6mm probe L 173mm capillary pipe 1430mm capillary pipe isolated 800mm gland nut M9x1 probe SS		
<b>For models:</b>	1320401-00, 1320401-01, 1420401-00, 1420401-01, 2020401-00, 2020401-01, 2120401-00, 2120401-01		

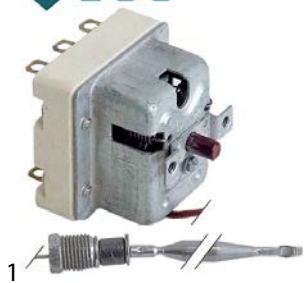
E-G-O



<b>Part No.</b>	375521	<b>Ref. No.</b>	203482 203483
<b>description</b>	safety thermostat switch-off temp. 240°C 3-pole 20A probe $\phi$ 6mm probe L 177mm capillary pipe 2380mm capillary pipe isolated 1100mm gland nut M9x1 probe SS		
<b>For models:</b>	0120101-00, 0120101C00, 0120105-00, 0120105C00, 0220301-00, 0220301B00, 0220301B01, 0220301B02, 0220301D00, 0220302-00, 0220302A00, 0220302A01, 0220302A02, 0220302A03, 0220302B00, 0220302B01, 0220302B02, 0220302C00, 0220302C01, 0220302C02, 0220302C03, 0220302D00, 0220302E00, 0220302E01, 0220302F00, 0220303-00, 0220303-01, 0220303A00, 0220303A01, 0220303A02, 0220303A03, 0220303B00, 0220303B01, 0220303C00, 0220303C01, 0220303C02, 0220303D00, 0220303D01, 0220303E00, 0220303E01, 0220304-00, 0220305-00, 0220306-00, 0520302-00, 0520303-00, 0520303-01, 0522101-01, 0522102-01, 1420301-00, 1420301B00... (Other models you can see in the webshop)		

## 55.32\_series

E-G-O



<b>Part No.</b>	375375	<b>Ref. No.</b>	900081
<b>description</b>	safety thermostat switch-off temp. 230°C 3-pole 20A probe $\phi$ 6mm probe L 94mm capillary pipe 900mm capillary pipe isolated 670mm gland nut M10x1 probe SS		

E-G-O



<b>Part No.</b>	375392	<b>Ref. No.</b>	203484
<b>description</b>	safety thermostat switch-off temp. 360°C 3-pole 1CO/2NC 20A probe $\phi$ 4mm probe L 120mm capillary pipe 1490mm capillary pipe isolated 1450mm gland nut probe SS		
<b>For models:</b>	0021130A00, 0021130A01, 0021135A00, 0221101-01, 0221101A01, 0221102-01, 0221103-01, 0221104-01, 0221104A01, 0221105-01, 0221106-01, 0221107-00, 0221107A00, 0221108-00, 0221109-00, 0221109A00, 0221110-00, 0522101-00, 0522102-00, 0721134-01, 0721134A01, 0721172A01, 0721173A01, 0721174A01, 0721175A01, 1022603-00, 1121117-00, 1121117-01, 1121117A00, 1121118-00, 1121118-01, 1121119-00, 1121119A00, 1121120-00, 1121121-00, 1121121A00, 1121135A01, 1220402-00, 1220402-01, 1221101-00, 1221101A00, 1221101B00, 1221102-00, 1221102A00, 1221102B00, 1221103-00, 1221103-01, 1221103-02, 1221103-04, 1221103A00... (Other models you can see in the webshop)		

## 55.33\_series

E-G-O




<b>Part No.</b>	375746	<b>Ref. No.</b>	203489
<b>description</b>	safety thermostat switch-off temp. 230°C 3-pole 20A probe $\phi$ 6mm probe L 117mm capillary pipe 1470mm capillary pipe isolated 1100mm gland nut M9x1 probe SS		
<b>For models:</b>	0120101-01, 0120101-02, 0120101-03, 0120101-04, 0120101D00, 0120101D01, 0120101D02, 0120101D04, 0120105-01, 0120105-02, 0120105-03, 0120105-04, 0120105D00, 0120105D01, 0120105D02, 0120105D04, 0220302H00, 0220302H01, 0220303H00, 0220303H01, 0520302-01, 0520302-02, 0520302A00, 0520302A01, 0520303-02, 0720325-03, 0720325-04, 0720325B03, 0720325B04, 1220301-00, 1220301-01, 1220301-02, 1220301-03, 1220301-04, 1220301B00, 1220301B01, 1220301B02, 1220301B03, 1220301B04, 1220301D00, 1220301D01, 1220301E00, 1220301E01, 1220301J00, 1220301J01, 1220301J02, 1220301J03, 1220302-00, 1220302-01, 1220302B00... (Other models you can see in the webshop)		




Part No.	375516	Ref. No.	203183
<b>description</b>	safety thermostat switch-off temp. 250°C 3-pole 20A probe ø 6mm probe L 107mm capillary pipe 1470mm capillary pipe isolated 1100mm gland nut M9x1 probe SS		
<b>For models:</b>	0522101-02, 0522101-03, 0522101-04, 0522102-02, 0522102-03, 0522102-04, 0722101-06, 1220504-01, 1221107-00, 1221108-00, 1320504-01, 1320504-02, 1321107-00, 1323208-00, 1323208-01, 1323208-02, 1323208-03, 1323208-04, 1323210-00, 1323210-01, 1323210-02, 1323210-03, 1323210-04, 1323403-00, 1323403K00, 1323506-00, 1323506-01, 1323506A00, 1323506A01, 1323517-00, 1323517A00, 1363403-00, 1363403-01, 1363403-02, 1363403-03, 1363403-04, 1363403-05, 1363415-05, 1420509-01, 1421122-00, 1422101-02, 1422101-03, 1422101-04, 1422101-05, 1422101-06, 1422102-02, 1422102-03, 1422102-04, 1422102-05, 1422104-05... (Other models you can see in the webshop)		

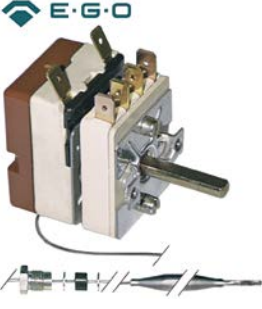
55.34\_series



Part No.	375246	Ref. No.	203408
<b>description</b>	thermostat t.max. 645°C temperature range 100-615/645°C 2-pole 2NO 16A probe ø 4mm probe L 230mm capillary pipe 1100mm capillary pipe isolated 600mm gland nut shaft ø 6x4.6mm shaft L 25mm shaft position lower rotation 270° outer switch 2NO probe material copper		
<b>For models:</b>	0723405-01, 0723405-02, 0723409-01, 0723409-02, 0723413-02, 0723414-02, 1023410-00, 1423404-00, 1423404-01, 1423405-00, 1423405-01, 1423405-02, 1423409-00, 1423409-01, 1423409-02, 1423413-02, 1423414-02, 1423510A00, 1423511A00, 1423526A00, 1423527A00, 1424819-00, 1424826-00, 1523405-00, 1523405-01, 1523409-00, 1523409-01, 1523410-00, 2023206-00, 2023206-01, 2023206-02, 2023207-00, 2023207-01, 2023207-02, 2023207-03, 2023207-04, 2023207-05, 2023405-00, 2023405D00, 2023406-00, 2023409-00, 2023511A00, 2023512A00, 2061409B00, 2061409B01, 2061411B00, 2061411B01, 3023206-00, 3023206-01, 3023206-02... (Other models you can see in the webshop)		

control thermostats with operation switch

55.13\_series



Part No.	375052	Ref. No.	203481
<b>description</b>	thermostat t.max. 195°C temperature range 140-195°C 1-pole 1NO 16A probe ø 6mm probe L 77mm capillary pipe 830mm capillary pipe isolated 500mm gland nut M9x1 shaft ø 6x4.6mm shaft L 23mm shaft position upper rotation 270° outer switch 2NO		
<b>For models:</b>	0120101-01, 0120101-02, 0120101-03, 0120101-04, 0120101D00, 0120101D01, 0120101D02, 0120101D04, 0120105-01, 0120105-02, 0120105-03, 0120105-04, 0120105D00, 0120105D01, 0120105D02, 0120105D04, 0520302-01, 0520302-02, 0520302A00, 0520302A01, 1820301-00, 1820301-01, 1820301-02, 2160501-00		

accessories

probe clips


clamps



for thermostat




Part No.	550878	Ref. No.	208057 575077
<b>description</b>	probe clip for pipe ømm for probe ø 6mm Qty 1 pcs		
<b>For models:</b>	0120101-00, 0120101-01, 0120101-02, 0120101-03, 0120101-04, 0120101C00, 0120101D00, 0120101D01, 0120101D02, 0120101D04, 0120105-00, 0120105-01, 0120105-02, 0120105-03, 0120105-04, 0120105C00, 0120105D00, 0120105D01, 0120105D02, 0120105D04, 0120202-00, 0120203-00, 0220301-00, 0220301B00, 0220301B01, 0220301B02, 0220301D00, 0220302-00, 0220302B00, 0220302B01, 0220302B02, 0220302D00, 0220302E00, 0220302E01, 0220302F00, 0220302H00, 0220302H01, 0220303-00, 0220303-01, 0220303B00, 0220303B01, 0220303D00, 0220303D01, 0220303E00, 0220303E01, 0220303H00, 0220303H01, 0220501-00, 0220502-00, 0220503-00... (Other models you can see in the webshop)		





			
1			
<b>Part No.</b>	550877	<b>Ref. No.</b>	208058 575076
<b>description</b>	probe clip for pipe ømm for probe ø 8mm Qty 1 pcs		
<b>For models:</b>	0120101-00, 0120101-01, 0120101-02, 0120101-03, 0120101-04, 0120101C00, 0120101D00, 0120101D01, 0120101D02, 0120101D04, 0120105-00, 0120105-01, 0120105-02, 0120105-03, 0120105-04, 0120105C00, 0120105D00, 0120105D01, 0120105D02, 0120105D04, 0120202-00, 0120202-01, 0120203-00, 0120203-01, 0220301-00, 0220301B00, 0220301B01, 0220301B02, 0220301D00, 0220302-00, 0220302B00, 0220302B01, 0220302B02, 0220302D00, 0220302E00, 0220302E01, 0220302F00, 0220302H00, 0220302H01, 0220303-00, 0220303-01, 0220303B00, 0220303B01, 0220303D00, 0220303D01, 0220303E00, 0220303E01, 0220303H00, 0220303H01, 0220501-00... (Other models you can see in the webshop)		


			
1			
<b>Part No.</b>	550556	<b>Ref. No.</b>	208062
<b>description</b>	probe clip for pipe ø 2x8.5mm for probe ømm for heating elements spacing 25mm Qty 1 pcs L 37mm W 10mm		
<b>For models:</b>	0120101-00, 0120101-01, 0120101-02, 0120101-03, 0120101-04, 0120101C00, 0120101D00, 0120101D01, 0120101D02, 0120101D04, 0120105-00, 0120105-01, 0120105-02, 0120105-03, 0120105-04, 0120105C00, 0120105D00, 0120105D01, 0120105D02, 0120105D04, 0120202-00, 0120203-00, 0520302A00, 0520302A01, 0720504-04, 1020510-00, 1120510-00, 1120510-01, 1220303A00, 1220303A01, 1220303A02, 1220303A03, 1220303C00, 1220303C01, 1220303C02, 1220303C03, 1220303F01, 1220303F02, 1220303F03, 1220303H00, 1220303H01, 1220303H02, 1220303H03, 1220304A00, 1220304A01, 1220304A02, 1220304C00, 1220304C01, 1220304C02, 1220304F00... (Other models you can see in the webshop)		
<b>accessories for</b>	550556		
	<b>Part No.</b>	550557	<b>Ref. No.</b> 208063
spacer piece			


			
1			
<b>Part No.</b>	550135	<b>Ref. No.</b>	208059 575022 945071
<b>description</b>	probe clip for pipe ø 8.5mm for probe ø 6mm L 25mm Qty 10 pcs		
<b>For models:</b>	0021130A00, 0021130A01, 0021135A00, 0120101-00, 0120101-01, 0120101-02, 0120101C00, 0120101D00, 0120101D01, 0120105-01, 0120105-02, 0120105D00, 0120105D01, 0120201-00, 0120201-01, 0220301-00, 0220301B00, 0220301B01, 0220301B02, 0220301D00, 0220302-00, 0220302B00, 0220302B01, 0220302B02, 0220302D00, 0220302E00, 0220302E01, 0220302F00, 0220302H00, 0220302H01, 0220303-00, 0220303-01, 0220303B00, 0220303B01, 0220303D00, 0220303D01, 0220303E00, 0220303E01, 0220303H00, 0220303H01, 0221101-01, 0221101A01, 0221102-01, 0221103-01, 0221104-01, 0221104A01, 0221105-01, 0221106-01, 0221107-00, 0221107A00... (Other models you can see in the webshop)		

protective pipes for capillary pipes			
1			
<b>Part No.</b>		<b>Ref. No.</b>	935211
<b>description</b>	protective pipe for capillaries		
<b>For models:</b>	0220501-00, 0220502-00, 0220503-00, 0220802-00, 0522101-00, 0522101-01, 0522101-02, 0522101-03, 0522102-00, 0522102-01, 0522102-02, 0522102-03, 1323208-00, 1323208-01, 1323208-02, 1323208-03, 1323210-00, 1323210-01, 1323210-02, 1363403-00, 1363403-01, 1363403-02, 1420501-00, 1420502-00, 1420504-00, 1420505-00, 1420801-00, 1420803-00, 1422101-00, 1422101-01, 1422101-02, 1422101-03, 1422102-00, 1422102-01, 1422102-02, 1422102-03, 14621011-0, 2020501-00, 2020501-01, 20205011-0, 2020502-00, 2020503-0, 2020504-00, 2020505-00, 2023203-00, 2023203-01, 2023203-02, 2023203-03, 2023203-04, 2023203-05... (Other models you can see in the webshop)		

			
1			
<b>Part No.</b>	550385	<b>Ref. No.</b>	541673
<b>description</b>	protective pipe for capillaries thread M10x1 H1 120mm L1 50mm L2 125mm		
<b>For models:</b>	0120101-00, 0120101-01, 0120101-02, 0120101-03, 0120101-04, 0120101C00, 0120101D00, 0120101D01, 0120101D02, 0120101D04		


			
1			
<b>Part No.</b>	550386	<b>Ref. No.</b>	541674
<b>description</b>	protective pipe for capillaries thread M10x1 H1 148mm L1 46mm L2 100mm		
<b>For models:</b>	0120105-00, 0120105-01, 0120105-02, 0120105-03, 0120105-04, 0120105C00, 0120105D00, 0120105D01, 0120105D02, 0120105D04		

			
1			
<b>Part No.</b>	551107	<b>Ref. No.</b>	935206 935526
<b>description</b>	protective pipe for capillaries thread M10x1 H1 200mm H2 12mm L1 190mm L2 95mm		
<b>For models:</b>	0220301-00, 0220301B00, 0220301B01, 0220301B02, 0220301D00, 0220302-00, 0220302A00, 0220302A01, 0220302A02, 0220302A03, 0220302B00, 0220302B01, 0220302B02, 0220302C00, 0220302C01, 0220302C02, 0220302C03, 0220302D00, 0220302E00, 0220302E01, 0220302F00, 0220302H00, 0220302H01, 0220303-00, 0220303-01, 0220303A00, 0220303A01, 0220303A02, 0220303A03, 0220303B00, 0220303B01, 0220303C00, 0220303C01, 0220303C02, 0220303D00, 0220303D01, 0220303E00, 0220303E01, 0220303H00, 0220303H01, 0220304-00, 0220305-00, 0220306-00, 0720325-03, 0720325-04, 0720325B03, 0720325B04, 0720332P00, 0720332R00, 0720332T00... (Other models you can see in the webshop)		

<b>Part No.</b>	550380	<b>Ref. No.</b>	541219
<b>description</b>	protective pipe for capillaries thread M10x1 H1 215mm H2 190mm L1 67mm L2 30mm		
<b>For models:</b>	0520302-00, 0520302-01, 0520302-02		

### plunger sockets




<b>Part No.</b>	550285	<b>Ref. No.</b>	541221 935211
<b>description</b>	protection pipe thread M12x0.75 IT M9x1 ET M12x0.75 L 66mm SS single ø 10mm		

## switches and momentary switches

### rocker/momentary rocker switches


#### 30x22mm



<b>Part No.</b>	301060	<b>Ref. No.</b>	203235 301060
<b>description</b>	rocker switch mounting measurements 30x22mm red 2NO 250V 16A illuminated connection male faston 6.3mm ambient temperature max. 125/55°C protection IP40		
<b>For models:</b>	0521705-01, 0521706-00, 1224002-00, 1224002-01, 1224003-00, 1224003-01, 1224004-00, 1224004-01, 1224005-00, 1224005-01, 1224006-00, 1224006-01, 1224007-00, 1224007-01, 1224008-00, 1224008-01, 1224009-00, 1224009-01, 2020339A00, 2020339A01, 2062801-00, 2062801A00, 2062801B00, 2062801C00, 2062802-00, 20628022-2, 2062802A00, 2062802B00, 2062802C00, 2062803-00, 20628033-1, 20628033-2, 2062803A00, 2062803B00, 2062803C00, 2062804-00, 20628044-1, 20628044-2, 2062804A00, 2062804B00, 2062804C00, 2062806-00, 2062806A00, 2062806B00, 2062806B01, 2062806B02, 2062806B03, 2062806C00, 2062806C01, 2062806C02... (Other models you can see in the webshop)		

### push/momentary push switches

#### 30x22mm




<b>Part No.</b>	301048 <sup>1</sup>	<b>Ref. No.</b>	203320
<b>description</b>	push switch mounting measurements 30x22mm yellow 2NO 250V 16A illuminated connection male faston 6.3mm ambient temperature max. 85°C protection IP40 latching		
<b>For models:</b>	20628022-0, 20628022-1, 20628033-0, 20628044-0, 20629011-0, 20629022-0		

<sup>1</sup>illuminated

## accessories


### push buttons




<b>Part No.</b>	348214	<b>Ref. No.</b>	207186
<b>description</b>	button for display PCB transparent suitable for MKN ED ø 16mm H 4.8mm for combi-steamer		
<b>For models:</b>	CSE11-L, CSE11-R, CSE11-R-DG, CSE12-L, CSE12-R, CSE12-R-DG, CSE21-L, CSE21-R, CSE21-R-DG, CSE22-L, CSE22-R, CSE22-R-DG, CSE61-L, CSE61-R, CSE61-R-DG, CSE62-L, CSE62-R, CSE62-R-DG, CSG11-L, CSG11-R, CSG11-R-DG, CSG12-L, CSG12-R, CSG12-R-DG, CSG21-L, CSG21-R, CSG21-R-DG, CSG22-L, CSG22-R, CSG22-R-DG, CSG61-L, CSG61-R, CSG61-R-DG, CSG62-L, CSG62-R, CSG62-R-DG		

## microswitches

### lever actuated



<b>Part No.</b>	346456	<b>Ref. No.</b>	203340
<b>description</b>	microswitch with lever 250V 0.1A 1CO connection male faston 6.3mm L 36mm ambient temperature max. 85°C mounting distance 22mm type CHERRY D41Y actuating force: 25g lever length 26mm		
<b>For models:</b>	0521706-00, 1220304A00, 1220304A01, 1220304A02, 1220304C00, 1220304C01, 1220304C02, 1220304F00, 1220304F01, 1220304H00, 1220304H01, 1220306A00, 1220306A01, 1220306A02, 1220306A03, 1220306A04, 1220306C00, 1220306C01, 1220306C02, 1220306C03, 1220306C04, 1220306F00, 1220306F01, 1220306F02, 1220306F03, 1220306H00, 1220306H01, 1220306H02, 1220306H03, 1320304A00, 1320304A01, 1320304A02, 1320304C00, 1320304C01, 1320304C02, 1320304F00, 1320304F01, 1320304F02, 1320304F03, 1320304F04, 1320304H00, 1320304H01, 1320304H02, 1320304H03, 1320304H04, 1320306A01, 1320306A02, 1320306A03, 1320306C01, 1320306C02... (Other models you can see in the webshop)		



<b>Part No.</b>	345255	<b>Ref. No.</b>	203334
<b>description</b>	microswitch with lever 250V 16A 1CO connection male faston 6.3mm L 35mm L1 28mm ambient temperature max. 125°C mounting distance 22mm actuating force: 136g lever length 27mm		
<b>For models:</b>	0220301-00, 0220301B00, 0220301B01, 0220301B02, 0220301D00, 0220302-00, 0220302A00, 0220302A01, 0220302A02, 0220302A03, 0220302B00, 0220302B01, 0220302B02, 0220302C00, 0220302C01, 0220302C02, 0220302C03, 0220302D00, 0220302E00, 0220302E01, 0220302F00, 0220302H00, 0220302H01, 0220303-00, 0220303-01, 0220303A00, 0220303A01, 0220303A02, 0220303A03, 0220303B00, 0220303B01, 0220303C00, 0220303C01, 0220303C02, 0220303D00, 0220303D01, 0220303E00, 0220303E01, 0220303H00, 0220303H01, 1420301-00, 1420301B00, 1420302-00, 1420302A00, 1420302B00, 1420302C00, 1420303-00, 1420303A00, 1420303B00, 1420303C00... (Other models you can see in the webshop)		





1

<b>Part No.</b>	345702	<b>Ref. No.</b>	203339
<b>description</b>	microswitch with lever 250V 6A 1CO connection male faston 6.3mm L 35mm ambient temperature max. 85°C mounting distance 22mm actuating force: 60g		
<b>For models:</b>	0720325-03, 0720325-04, 0720325B03, 0720325B04, 0720332P00, 0720332R00, 0720332T00, 0720332V00, 1220301-00, 1220301-01, 1220301-02, 1220301-03, 1220301-04, 1220301B00, 1220301B01, 1220301B02, 1220301B03, 1220301B04, 1220301D00, 1220301D01, 1220301E00, 1220301E01, 1220301J00, 1220301J01, 1220301J02, 1220301J03, 1220302-00, 1220302-01, 1220302B00, 1220302B01, 1220302D00, 1220302E00, 1220303-00, 1220303-01, 1220303-02, 1220303-03, 1220303-04, 1220303-05, 1220303A00, 1220303A01, 1220303A02, 1220303A03, 1220303B00, 1220303B01, 1220303B02, 1220303B03, 1220303B04, 1220303B05, 1220303C00, 1220303C01... (Other models you can see in the webshop)		

pin-plunger actuated

miscellaneous



1

<b>Part No.</b>	347023	<b>Ref. No.</b>	203232
<b>description</b>	microswitch 250V 16A connection screw connection ambient temperature max. 125°C mounting distance 96mm		
<b>For models:</b>	2020307A00		

float switches



1

<b>Part No.</b>	401464	<b>Ref. No.</b>	203210
<b>description</b>	float switch thread M46x2 1NO ø 44mm L 140mm mounting ø 46mm 250V 5A cable cable length 2000mm		
<b>For models:</b>	14228011-0, 14228022-0, 14228033-0, 14228044-0, 14228055-0, 2022801-00, 2022801-01, 2022801A00, 2022801A01, 2022801B00, 2022801B01, 2022801C00, 2022801C01, 2022802-00, 2022802-01, 2022802A00, 2022802A01, 2022802B00, 2022802B01, 2022802C00, 2022802C01, 2022803-00, 2022803-01, 2022803A00, 2022803A01, 2022803B00, 2022803B01, 2022803C00, 2022803C01, 2022804-00, 2022804-01, 2022804A00, 2022804A01, 2022804B00, 2022804B01, 2022804C00, 2022804C01, 2022805-00, 2022805-01, 2022805A00, 2022805A01, 2022805B00, 2022805B01, 2022805C00, 2022805C01, 2022806-00, 2022806A00, 2022806B00, 2022806B01, 2022806B02... (Other models you can see in the webshop)		

cam switches

on/off




1

<b>Part No.</b>	347953	<b>Ref. No.</b>	203958
<b>description</b>	cam switch 4 operating positions 2NO sequence 0-1-0-1 16A shaft ø 6x4.6mm shaft L 23mm connection male faston 6.3mm ON-OFF plastic		
<b>For models:</b>	0524301-01, 0524302-01, 0524303-01, 0524304-01, 0721134-01, 0721134A01, 0721172A01, 0721173A01, 0721174A01, 0721175A01, 1221103-04, 1221103B04, 1221130J00, 1221135A04, 1221135J00, 1221136A04, 1221141-00, 1221141A00, 1221156A00, 1222507-00, 1222509-00, 1321130-00, 1321130A00, 1321131-00, 1321131A00, 1321135A03, 1321136A03, 1321141-00, 1321141A00, 1322507-00, 1322509-00, 1421117-03, 1421118-03, 1421126B00, 1421127B00, 1421130B00, 1421131-00, 1421131A00, 1421131B00, 1421139-00, 1421139A00, 1421139B00, 1421141-00, 1421141A00, 1421141B00, 1421143B01, 1421144B01, 1421145B01, 1421149B00, 1421149B01... (Other models you can see in the webshop)		



1

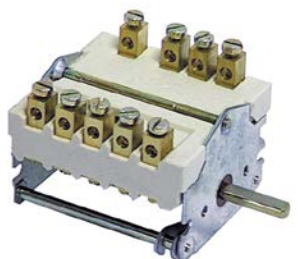
<b>Part No.</b>	300021	<b>Ref. No.</b>	203563
<b>description</b>	cam switch 4 operating positions 4NO sequence 0-1-0-1 16A shaft ø 6x4.6mm shaft L 23mm connection screw ceramic		
<b>For models:</b>	0120101-00, 0120101C00, 0120105-00, 0120105C00, 0220301-00, 0220301B00, 0220301B01, 0220301B02, 0220301D00, 0220302-00, 0220302A00, 0220302A01, 0220302A02, 0220302A03, 0220302C00, 0220302C01, 0220302C02, 0220302C03, 0220302D00, 0220302F00, 0220302H00, 0220302H01, 0220303B00, 0220303B01, 0220303C00, 0220303C01, 0220303C02, 0220303E00, 0220303E01, 0220303H00, 0220303H01, 0220304-00, 0220305-00, 0220306-00, 0220501-00, 0220502-00, 0220503-00, 0220601-00, 0220802-00, 0221001H00, 0221202-00, 0221501-00, 0221502-00, 0520302-00, 0520303-00, 0520303-01, 0520303-02, 0520901-00, 0522101-01, 0522101-02... (Other models you can see in the webshop)		

1

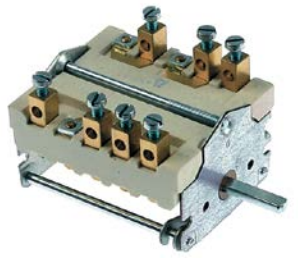
<b>Part No.</b>	300102	<b>Ref. No.</b>	203564
<b>description</b>	cam switch 4 operating positions 4NO sequence 0-1-0-1 32A shaft ø 6x4.6mm shaft L 23mm connection screw ceramic		
<b>For models:</b>	0021130A00, 0021130A01, 0021135A00, 0220302B00, 0220302B01, 0220302B02, 0220302E00, 0220302E01, 0220303-00, 0220303-01, 0220303A00, 0220303A01, 0220303A02, 0220303A03, 0220303D00, 0220303D01, 0220306-00, 0221101-00, 0221101-01, 0221101A00, 0221101A01, 0221102-00, 0221102-01, 0221103-00, 0221103-01, 0221104-00, 0221104-01, 0221104A00, 0221104A01, 0221105-00, 0221105-01, 0221106-00, 0221106-01, 0221107-00, 0221107A00, 0221108-00, 0221109-00, 0221109A00, 0221110-00, 0522101-00, 0522102-00, 0723104-03, 0723104A03, 0723104B03, 0723405-01, 0723405-02, 0723409-01, 0723409-02, 0723412K01, 0723413-02... (Other models you can see in the webshop)		

### 4-position



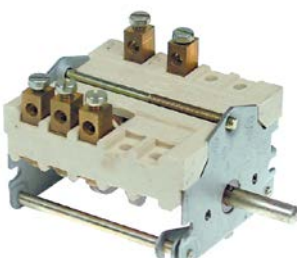
1

<b>Part No.</b>	300104	<b>Ref. No.</b>	203074
<b>description</b>	cam switch 4 operating positions 3NO/1CO sequence 0-1-2-3 32A shaft ø 6x4.6mm shaft L 23mm connection screw ceramic		



1


<b>Part No.</b>	300194	<b>Ref. No.</b>	203223 203228
<b>description</b>	cam switch 4 operating positions 4NO sequence 0-1-2-3 16A shaft ø 6x4.6mm shaft L 23mm connection screw 4-position ceramic		
<b>For models:</b>	0522101-03, 0522101-04, 0522102-03, 0522102-04, 0722101-06, 1323208-02, 1323208-03, 1323208-04, 1323210-00, 1323210-01, 1323210-02, 1323210-03, 1323210-04, 1323403-00, 1323403K00, 1323506-00, 1323506-01, 1323506A00, 1323506A01, 1323517-00, 1323517A00, 1363403-02, 1363403-03, 1363403-04, 1363403-05, 1363415-05, 1422101-03, 1422101-04, 1422101-05, 1422101-06, 1422102-03, 1422102-04, 1422102-05, 1422104-05, 1422104A05, 1422105-05, 1422105A05, 1422106-05, 1422106-06, 1422106A05, 1422106A06, 1422107-05, 1422107-06, 1422107A05, 1422107A06, 1422301-01, 2023114-00, 2023118-00, 2023119-00, 2023203-05... (Other models you can see in the webshop)		



1

<b>Part No.</b>	300192	<b>Ref. No.</b>	203216
<b>description</b>	cam switch 4-position sequence 0-3-2-1 32A shaft ø 6x4.6mm connection screw clamp 2-pole		
<b>For models:</b>	2023302-00, 2023303-00, 2023304-00, 2023305-00		




### 7-position



1

<b>Part No.</b>	300025	<b>Ref. No.</b>	203224
<b>description</b>	cam switch 7 operating positions 1NO/2CO sequence 0-1-2-3-4-5-6 16A shaft ø 6x4.6mm shaft L 23mm connection screw 7-position ceramic		
<b>For models:</b>	0223202-00, 1223201-00, 1223201-01, 1223202-00, 1223207-00, 1223207-01, 1323201-00, 1323201-01, 1323201-02, 1323207-00, 1323207-02, 1323208-00, 1323208-01, 1323208-02, 1323208-03, 1323208-04, 1424802-00, 1424802-01, 1424802-02, 1424808-00, 1424808-01, 1424808-02, 1424808-03, 1424809-00, 1424809-01, 1424809-02, 1424809-09, 1424811-00, 1424811-01, 1424811-02, 1424811-03, 1424812-00, 1424812-01, 1424812-02, 1424813-00, 1424813-01, 1424813-02, 1424816-00, 18232011-0, 2023201-00, 2023201-01, 2023201-02, 2023201-03, 20232011-0, 20232011-1, 2023201A00, 2023201A01, 2023202-00, 2023202-01, 2023202-02... (Other models you can see in the webshop)		

**accessories for** 300025

	<b>Part No.</b>	112172	<b>Ref. No.</b>	—
knob universal ø 70mm black without adaptor/dial plate				
	<b>Part No.</b>	112213	<b>Ref. No.</b>	—
knob dial plate silver switch 7-position t.max.°C ED ø 63mm ID ø 45.5mm				
	<b>Part No.</b>	112311	<b>Ref. No.</b>	—
knob adapter shaft ø 6x4.6mm L 0mm with spring				

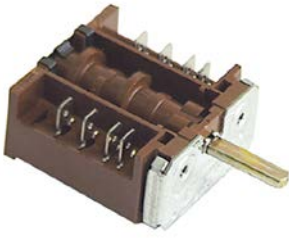


1

<b>Part No.</b>	300106	<b>Ref. No.</b>	203560
<b>description</b>	cam switch 7 operating positions 1NO/2CO sequence 0-1-2-3-4-5-6 32A shaft ø 6x4.6mm shaft L 23mm connection screw 7-position shaft flat upper		
<b>For models:</b>	1320401-00, 1320401-01, 1420401-00, 1420401-01, 2020401-00, 2020401-01, 2120401-00, 2120401-01		



### 4 operating positions



1

<b>Part No.</b>	300170	<b>Ref. No.</b>	203414
<b>description</b>	cam switch 4 operating positions 3NO sequence 0-1-2-3 16A shaft ø 6x4.6mm shaft L 23mm connection male faston 6.3mm		
<b>For models:</b>	1220504-01, 1222601-00, 1320504-01, 1320504-02, 1322601-00, 1420509-01, 1422601-00, 1422602-00, 1422802B04, 1422802B05, 1422802B06, 1422802B07, 1422802B08, 1422804B04, 1422804B05, 1422804B06, 1422804B07, 1422804B08, 1422805B04, 1422805B05, 1422805B06, 1422805B07, 1422805B08, 1422807B00, 1422807B01, 1422807B02, 1422807B03, 1422807B04, 1422831-00, 1422832-00, 1422902-00, 1422902-01, 1422902-02, 1422902-03, 1422902-04, 1422908-00, 1462802B00, 1462802B01, 1462802B02, 1462802B03, 1462802B04, 1462802B05, 1462804B00, 1462804B01, 1462804B02, 1462804B03, 1462804B04, 1462804B05, 2020506-01, 2022601-00... (Other models you can see in the webshop)		



1

<b>Part No.</b>	300195	<b>Ref. No.</b>	203156
<b>description</b>	cam switch 4 operating positions 6NO sequence 0-1-2-3 16A shaft ø 6x4.6mm shaft L 23mm connection male faston 6.3mm		
<b>For models:</b>	1220304-00, 1220304-01, 1220304A00, 1220304A01, 1220304A02, 1220304B00, 1220304B01, 1220304C00, 1220304C01, 1220304C02, 1220304D00, 1220304E00, 1220304F00, 1220304F01, 1220304H00, 1220304H01, 1320304-00, 1320304-01, 1320304A00, 1320304A01, 1320304A02, 1320304B00, 1320304B01, 1320304C00, 1320304C01, 1320304C02, 1320304D00, 1320304D01, 1320304E00, 1320304E01, 1320304F00, 1320304F01, 1320304F02, 1320304F03, 1320304F04, 1320304H00, 1320304H01, 1320304H02, 1320304H03, 1320304H04, 2022801-02, 2022801-03, 2022801A02, 2022801A03, 2022801B02, 2022801B03, 2022801C02, 2022801C03, 2022802-02, 2022802-03... (Other models you can see in the webshop)		

### with potentiometer



1

<b>Part No.</b>	347952	<b>Ref. No.</b>	203894
<b>description</b>	cam switch 16 operating positions 3NO sequence 0-16 16A shaft ø 6x4.6mm shaft L 23mm connection male faston 2.8mm incl code pcb cable lengthmm codedOhm plastic		
<b>For models:</b>	0723104-03, 0723104A03, 0723104B03, 0723105-03, 0723105A03, 0723105B03, 1023101-00, 1023101-01, 1023106-00, 1023106-01, 1023111-00, 1023111-01, 1223101-00, 1223101-01, 1223101-02, 1223103-00, 1223103-01, 1223103-02, 1223106-00, 1223106-01, 1223106-02, 1223111-00, 1223203-03, 1223211-01, 1323101-00, 1323101-01, 1323101-02, 1323103-00, 1323103-01, 1323103-02, 1323106-00, 1323203-02, 1323211-02, 1423101-00, 1423101-01, 1423101-02, 1423101A00, 1423101A01, 1423103-00, 1423103-01, 1423103-02, 1423103A00, 1423103A01, 1423104-00, 1423104-01, 1423104-02, 1423104-03, 1423104A00, 1423104A01, 1423104A03... (Other models you can see in the webshop)		

## SWITCHES AND MOMENTARY SWITCHES MKN

### rotary switches

#### MOELLER/EATON



1

<b>Part No.</b>	347954	<b>Ref. No.</b>	203969
<b>description</b>	rotary switch 3 0-1-2 sets of contacts 4 type T0-2-15512 400V 16A shaft ø 5.8x6.9mm shaft L 27mm shaft square connection screw		

#### miscellaneous

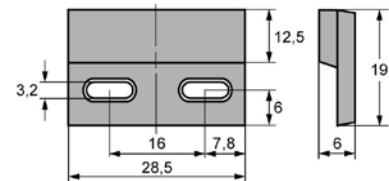


1

<b>Part No.</b>	346440	<b>Ref. No.</b>	203227
<b>description</b>	rotary switch sets of contacts 3 2 0-1 type B15R A-XF-X-XX 380V 10A shaft ø 5x5mm shaft L 21mm shaft square connection screw		

### magnetic switches

#### 28.5x19mm



1

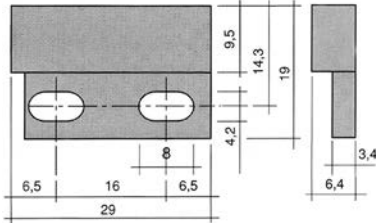
<b>Part No.</b>	345219	<b>Ref. No.</b>	203028
<b>description</b>	magnetic switch L 28.5mm W 19mm 1NO 230V 0.5A P max. 10W connection cable cable length 800mm		
<b>For models:</b>	0120101-01, 0120101-02, 0120101-03, 0120101-04, 0120101D00, 0120101D01, 0120101D02, 0120101D04, 0120105-01, 0120105-02, 0120105-03, 0120105-04, 0120105D00, 0120105D01, 0120105D02, 0120105D04, 0520302-01, 0520302-02, 0520302A00, 0520302A01, 0520303-01, 0520303-02, 1423901-00, 1423901-01, 1423901-02, 1423902-00, 1423902-01, 1423902-02, 1423903-00, 1423903-01, 1423903-02, 1424101-00, 1424101-01, 1424102-00, 1424102-01, 1424103-00, 1424104-00, 1820301-01, 1820301-02, 2012827-01, 2012827-02, 2012828-00, 2012828-01, 2012828-02, 2012828-03, 2012828-04, 2012828-05, 2012829-00, 2012829-01, 2012829-02... (Other models you can see in the webshop)		



29x19mm



1



<b>Part No.</b>	345808	<b>Ref. No.</b>	202722
<b>description</b>	magnetic switch L 29mm W 19mm 1CO 150V 0.5A P max. 10W connection cable length 1000mm		
<b>For models:</b>	CCE60, CCE63, CGE11-L, CGE11-R, CGE12-L, CGE12-R, CGE21-L, CGE21-R, CGE22-L, CGE22-R, CGE61-L, CGE61-R, CGE62-L, CGE62-R, CGG11-L, CGG11-R, CGG12-L, CGG12-R, CGG21-L, CGG21-R, CGG22-L, CGG22-R, CGG61-L, CGG61-R, CGG62-L, CGG62-R, CPE60, CPE63, CSE11-L, CSE11-R, CSE11-R-DG, CSE12-L, CSE12-R, CSE12-R-DG, CSE21-L, CSE21-R, CSE21-R-DG, CSE22-L, CSE22-R, CSE22-R-DG, CSE61-L, CSE61-R, CSE61-R-DG, CSE62-L, CSE62-R, CSE62-R-DG, CSG11-L, CSG11-R, CSG11-R-DG, CSG12-L...(Other models you can see in the webshop)		



1

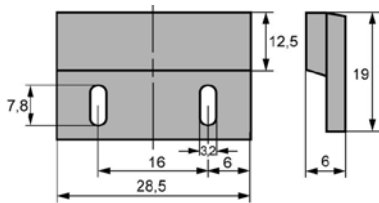
<b>Part No.</b>	348213	<b>Ref. No.</b>	10013771
<b>description</b>	magnetic switch L 29mm W 19mm 1NO 0.5A P max. 10W connection plug cable length 500mm 200VDC		

accessories

magnets



1



<b>Part No.</b>	345700	<b>Ref. No.</b>	203031
<b>description</b>	magnet ømm L 29mm H 6.5mm W 19mm hole distance 16mm M3 hole ø 3.5mm		

control equipment

MOELLER/EATON

signal element



1

<b>Part No.</b>	347524	<b>Ref. No.</b>	203110
<b>description</b>	signal element mounting measurements ø22mm with socket element blue with light bulb 130V		
<b>For models:</b>	0220302A00, 0220302A01, 0220302A02, 0220302A03, 0220302C00, 0220302C01, 0220302C02, 0220302C03, 0220302H00, 0220302H01, 0220303A00, 0220303A01, 0220303A02, 0220303A03, 0220303C00, 0220303C01, 0220303C02, 0220303H00, 0220303H01, 0220304-00, 0220305-00, 0220306-00		

button plates with symbol



1

<b>Part No.</b>	346464	<b>Ref. No.</b>	203303
<b>description</b>	button plate black automatic/manual		

switches (complete)

rotary switches



1

<b>Part No.</b>	346463	<b>Ref. No.</b>	203350
<b>description</b>	rotary selector mounting measurements ø22mm black 3NO sequence 1-0-2		
<b>For models:</b>	2013004B01, 2013004B02, 2013004B03, 2013004B04, 2013004B05, 2013008B01, 2013008B02, 2013008B03, 2013008B04, 2013008B05, 2013010B01, 2013010B02, 2013010B03, 2013010B04, 2013010B05, 2013018B00, 2013018B01, 2013018B02, 2013018B03, 2013018B04, 2020303-00, 2020303-01, 2020303-02, 2020303-03, 2020303-04, 2020303A00, 2020310-00, 2020310-01, 2020310-02, 2020310-03, 2020310A00, 2020310A01, 2020310A02, 2020310A03, 2020311-00, 2020311-01, 2020311-02, 2020311-03, 2020311A00, 2020311A01, 2020311A02, 2020311A03, 2020312A00, 2020312A01, 2020312A02, 2020314-01, 2020314-02, 2020314-03, 2020314A01, 2020314A02...(Other models you can see in the webshop)		

<b>spare parts for</b>	346463			
	<b>Part No.</b>	346292	<b>Ref. No.</b>	—
	<b>Part No.</b>	346293	<b>Ref. No.</b>	—
	<b>Part No.</b>	346462	<b>Ref. No.</b>	—
	momentary selector switch mounting measurements ø22mm black/white 330°-0°-30° momentary/momentary sequence 1-0-2			





1			
<b>Part No.</b>		<b>Ref. No.</b>	203365
<b>description</b>	rotary selector mounting measurements ø22mm black sequence 1-0-2		
<b>For models:</b>	2021404-00, 2021404-01, 2021404-02, 2021404-03, 2021404-04, 2021404A00, 2021404A01, 2021404A02, 2021404B00, 2021404B01, 2021404B02, 2021404C00, 2021404C01, 2021404C02, 2021406-00, 2021406-01, 2021406-02, 2021406B00, 2021406B01, 2023002-00, 2023002-01, 2023002-02, 2023002A00, 2023002B00, 2023002C00, 2023004-00, 2023004-01, 2023004-02, 2023004A00, 2023004B00, 2023004B01, 2023004B02, 2023004B03, 2023004B04, 2023004B05, 2023004B06, 2023004B07, 2023004C00, 2023006-00, 2023006-01, 2023006-02, 2023006A00, 2023006B00, 2023006C00, 2023008-00, 2023008-01, 2023008-02, 2023008A00, 2023008B00, 2023008C00, 2023008B01... (Other models you can see in the webshop)		

1			
<b>Part No.</b>	346461	<b>Ref. No.</b>	203367
<b>description</b>	rotary switch mounting measurements ø22mm black latching 1NC/1NO sequence 0-1		
<b>For models:</b>	2020303-00, 2020303-01, 2020303-02, 2020303-03, 2020303-04, 2020303A00, 2020310-00, 2020310-01, 2020310-02, 2020310-03, 2020310A00, 2020310A01, 2020310A02, 2020310A03, 2020311-00, 2020311-01, 2020311-02, 2020311-03, 2020311A00, 2020311A01, 2020311A02, 2020311A03, 2020312A00, 2020312A01, 2020312A02, 2020314-01, 2020314-02, 2020314-03, 2020314A01, 2020314A02, 2020314A03, 2020315-01, 2020315-02, 2020315-03, 2020315A01, 2020315A02, 2020315A03, 2020339A00, 2020339A01, 2020340A00, 2020340A01, 2020341-00, 2020341A00, 2020342-00, 2020342A00, 3020310-00, 3020310-01, 3020310A00, 3020310A01, 3020311-00... (Other models you can see in the webshop)		

## push/momentary push switches

1			
<b>Part No.</b>	346465 <sup>1</sup>	<b>Ref. No.</b>	203304
<b>description</b>	momentary push switch mounting measurements ø22mm black 1NC/1NO lifting countersink momentary		

<sup>1</sup>lift/decline

1			
<b>Part No.</b>	346489	<b>Ref. No.</b>	203313
<b>description</b>	momentary push switch mounting measurements ø22mm yellow illuminated, 80-264V 1NC/1NO momentary		
<b>For models:</b>	1424824-00, 1424824-01, 1462802B00, 1462802B01, 1462802B02, 1462802B03, 1462802B04, 1462802B05, 1462804B00, 1462804B01, 1462804B02, 1462804B03, 1462804B04, 1462804B05, 1462831-00, 1462832-00, 1462833-00, 1462834-00, 1462835-00, 1462836-00, 1462837-00, 1462838-00, 1462839-00, 1462840-00, 1462908-00, 1462910-00, 2061401-05, 2061401-06, 2061401-07, 2061401-08, 2061401A05, 2061401A06, 2061401A07, 2061401A08, 2061401B05, 2061401B06, 2061401B07, 2061401B08, 2061401C05, 2061401C06, 2061401C07, 2061401C08, 2061402-05, 2061402-06, 2061402-07, 2061402A05, 2061402A06, 2061402A07, 2061402B05, 2061402B06... (Other models you can see in the webshop)		

## lamps

1			
<b>Part No.</b>	359606	<b>Ref. No.</b>	203120
<b>description</b>	neon light bulb socket Ba9s 220V 2W clear ø 10mm L 28mm		
<b>For models:</b>	1424824-00, 1462802B00, 1462804B00, 2061401-05, 2061401A05, 2061401B05, 2061401C05, 2061402-05, 2061402A05, 2061402B05, 2061402C05, 2061403-00, 2061403-01, 2061403-02, 2061403-03, 2061403-04, 2061403A00, 2061403A02, 2061403A03, 2061403B00, 2061403B02, 2061403B03, 2061403C00, 2061403C02, 2061403C03, 2061404-00, 2061404-01, 2061404-02, 2061404-03, 2061404-04, 2061404A00, 2061404A02, 2061404A03, 2061404B00, 2061404B02, 2061404B03, 2061404C00, 2061404C02, 2061404C03, 2061405-00, 2061405-01, 2061405-02, 2061405B00, 2061405B01, 2061405B02, 2061406-00, 2061406-01, 2061406-02, 2061406B00, 2061406B01... (Other models you can see in the webshop)		
<b>accessories for</b>	359606		
	<b>Part No.</b>	359832	<b>Ref. No.</b>
			—
	lamp socket mounting measurements ø16.2mm socket Ba9s connection male faston 6.3mm		
	<b>Part No.</b>	359853	<b>Ref. No.</b>
			—
	lamp socket mounting measurements ø18.2mm socket Ba9s connection male faston 6.3mm		

## encoders and potentiometers

1			
<b>Part No.</b>	347952	<b>Ref. No.</b>	203894
<b>description</b>	cam switch 16 operating positions 3NO sequence 0-16 16A shaft ø 6x4.6mm shaft L 23mm connection male faston 2.8mm incl code pcb cable lengthmm codedOhm plastic		
<b>For models:</b>	0723104-03, 0723104A03, 0723104B03, 0723105-03, 0723105A03, 0723105B03, 1023101-00, 1023101-01, 1023106-00, 1023106-01, 1023111-00, 1023111-01, 1223101-00, 1223101-01, 1223101-02, 1223103-00, 1223103-01, 1223103-02, 1223106-00, 1223106-01, 1223106-02, 1223111-00, 1223203-03, 1223211-01, 1323101-00, 1323101-01, 1323101-02, 1323103-00, 1323103-01, 1323103-02, 1323106-00, 1423101-00, 1423101-01, 1423101-02, 1423101A00, 1423101A01, 1423103-00, 1423103-01, 1423103-02, 1423103A00, 1423103A01, 1423104-00, 1423104-01, 1423104-02, 1423104-03, 1423104A00, 1423104A01, 1423104A03... (Other models you can see in the webshop)		

1			
<b>Part No.</b>	401968	<b>Ref. No.</b>	203733
<b>description</b>	potentiometer with momentary function		
<b>For models:</b>	CCE60, CCE63, CGE11-L, CGE11-R, CGE12-L, CGE12-R, CGE21-L, CGE21-R, CGE22-L, CGE22-R, CGE61-L, CGE61-R, CGE62-L, CGE62-R, CGG11-L, CGG11-R, CGG12-L, CGG12-R, CGG21-L, CGG21-R, CGG22-L, CGG22-R, CGG61-L, CGG61-R, CGG62-L, CGG62-R, CPE60, CPE63, CSE11-L, CSE11-R, CSE12-L, CSE12-R, CSE21-L, CSE21-R, CSE22-L, CSE22-R, CSE61-L, CSE61-R, CSE62-L, CSE62-R, CSG11-L, CSG11-R, CSG12-L, CSG12-R, CSG61-L, CSG61-R, CSG62-L, CSG62-R		






# lamps

## indicator lights


### indicator lights 2-piece (lens and indicator lamp)

#### indicator light lenses

ø10mm (type SRZ-4)

 <p>1</p>			
<b>Part No.</b>	359121	<b>Ref. No.</b>	203107
<b>description</b>	indicator light housings mounting measurements ø10mm yellow arrow Qty 1 pcs		


#### indicator lamps for socket type SRZ / SDK / SDY / SFK



 <p>1</p>			
<b>Part No.</b>	359132	<b>Ref. No.</b>	203107
<b>description</b>	indicator lamp green 250V connection male faston 6.3mm protection IP54 ambient temperature max. 85°C		


### indicator lights 3-piece (housing, lens and bulb)

#### lamps

#### neon light bulbs

 <p>1</p>			
<b>Part No.</b>	359606	<b>Ref. No.</b>	203120
<b>description</b>	neon light bulb socket Ba9s 220V 2W clear ø 10mm L 28mm		
<b>For models:</b>	1424824-00, 1462802B00, 1462804B00, 2061401-05, 2061401A05, 2061401B05, 2061401C05, 2061402-05, 2061402A05, 2061402B05, 2061402C05, 2061403-00, 2061403-01, 2061403-02, 2061403-03, 20614033-0, 2061403A00, 2061403A02, 2061403A03, 2061403B00, 2061403B02, 2061403B03, 2061403C00, 2061403C02, 2061403C03, 2061404-00, 2061404-01, 2061404-02, 2061404-03, 20614044-0, 2061404A00, 2061404A02, 2061404A03, 2061404B00, 2061404B02, 2061404B03, 2061404C00, 2061404C02, 2061404C03, 2061405-00, 2061405-01, 2061405-02, 2061405B00, 2061405B01, 2061405B02, 2061406-00, 2061406-01, 2061406-02, 2061406B00, 2061406B01... (Other models you can see in the webshop)		


<b>accessories for</b>	359606			
	<b>Part No.</b>	359832	<b>Ref. No.</b>	—
	lamp socket mounting measurements ø16.2mm socket Ba9s connection male faston 6.3mm			
	<b>Part No.</b>	359853	<b>Ref. No.</b>	—
	lamp socket mounting measurements ø18.2mm socket Ba9s connection male faston 6.3mm			

 <p>1</p>			
<b>Part No.</b>	359603	<b>Ref. No.</b>	203106 359106
<b>description</b>	neon light bulb socket E14 380V clear ø 14mm L 30mm		
<b>For models:</b>	0522101-00		

### indicator lights (complete)


ø10mm


with plug-in socket

 <p>1</p>			
<b>Part No.</b>	359864	<b>Ref. No.</b>	203107
<b>description</b>	indicator light ø 10mm 230V red		


ø16mm

with plug-in socket


 <p>1</p>			
<b>Part No.</b>	359094	<b>Ref. No.</b>	203711
<b>description</b>	indicator light ø 16mm 400V yellow cable length 200mm cable material silicone wire		
<b>For models:</b>	00217022-0, 0520302-00, 0520901-00, 0521701-00, 0521701-01, 0521702-00, 0521702-01, 0521702-02, 0521702-03, 0521702-04, 0521702A02, 0521702A03, 0521702A04, 0521702B03, 0521702B04, 0521702C04		


 <p>1</p>			
<b>Part No.</b>	359093	<b>Ref. No.</b>	203429
<b>description</b>	indicator light ø 16mm 400V white cable length 200mm cable material silicone wire		
<b>For models:</b>	0120101-00, 0120101-01, 0120101-02, 0120101-03, 0120101-04, 0120101C00, 0120101D00, 0120101D01, 0120101D02, 0120101D04, 0120105-00, 0120105-01, 0120105-02, 0120105-03, 0120105-04, 0120105C00, 0120105D00, 0120105D01, 0120105D02, 0120105D04, 0520302-00, 0520302-01, 0520302-02, 0520302A00, 0520302A01		

ø22mm

 <p>1</p>			
<b>Part No.</b>	357020	<b>Ref. No.</b>	203103
<b>description</b>	indicator light ø 22mm white 230-440V connection screw temp.-resist. 125°C LED		
<b>For models:</b>	0021130A00, 0021130A01, 0021135A00, 0120201-00, 0120201-01, 0120202-00, 0120202-01, 0120203-00, 0120203-01, 0220301-00, 0220301B00, 0220301B01, 0220301B02, 0220301D00, 0220302-00, 0220302A00, 0220302A01, 0220302A02, 0220302A03, 0220302B00, 0220302B01, 0220302B02, 0220302C00, 0220302C01, 0220302C02, 0220302C03, 0220302D00, 0220302E00, 0220302E01, 0220302F00, 0220302H00, 0220302H01, 0220303-00, 0220303-01, 0220303A00, 0220303A01, 0220303A02, 0220303A03, 0220303B00, 0220303B01, 0220303C00, 0220303C01, 0220303C02, 0220303D00, 0220303D01, 0220303E00, 0220303E01, 0220303H00, 0220303H01, 0220304-00... (Other models you can see in the webshop)		




			
1			
<b>Part No.</b>	357263	<b>Ref. No.</b>	203893
<b>description</b>	indicator light ø 22mm white 24V connection male faston 2.8mm plastic		
<b>For models:</b>	0723104-03, 0723104A03, 0723104B03, 0723105-03, 0723105A03, 0723105B03, 1023101-00, 1023101-01, 1023106-00, 1023106-01, 1023111-00, 1023111-01, 1223101-00, 1223101-01, 1223101-02, 1223103-00, 1223103-01, 1223103-02, 1223106-00, 1223106-01, 1223106-02, 1223111-00, 1223203-03, 1223211-01, 1323101-00, 1323101-01, 1323101-02, 1323103-00, 1323103-01, 1323103-02, 1323106-00, 1323203-02, 1323211-02, 1423101-00, 1423101-01, 1423101-02, 1423101A00, 1423101A01, 1423103-00, 1423103-01, 1423103-02, 1423103A00, 1423103A01, 1423104-00, 1423104-01, 1423104-02, 1423104-03, 1423104A00, 1423104A01, 1423104A03... (Other models you can see in the webshop)		

			
1			
<b>Part No.</b>	357021	<b>Ref. No.</b>	203101
<b>description</b>	indicator light ø 22mm yellow 230-440V connection screw temp.-resist. 125°C LED		
<b>For models:</b>	0220302F00, 0520303-00, 0520303-01, 0520303-02, 1220303I00, 1220303I01, 1220303I02, 14228011-0, 14228022-0, 1422802B04, 1422802B05, 1422802B06, 1422802B07, 1422802B08, 14228033-0, 14228044-0, 1422804B04, 1422804B05, 1422804B06, 1422804B07, 1422804B08, 14228055-0, 1422805B04, 1422805B05, 1422805B06, 1422805B07, 1422805B08, 1422807B00, 1422807B01, 1422807B02, 1422807B03, 1422807B04, 1422831-00, 1422832-00, 1422833-00, 1422834-00, 1422902-00, 1422902-01, 1422902-02, 1422902-03, 1422902-04, 1422908-00, 1422910-00, 2012813-00, 2012907-00, 2012907-01, 2022801-00, 2022801-01, 2022801-02, 2022801-03... (Other models you can see in the webshop)		

## screw-on/push-on fit


## neon light bulbs


			
1			
<b>Part No.</b>	359606	<b>Ref. No.</b>	203120
<b>description</b>	neon light bulb socket Ba9s 220V 2W clear ø 10mm L 28mm		
<b>For models:</b>	1424824-00, 1462802B00, 1462804B00, 2061401-05, 2061401A05, 2061401B05, 2061401C05, 2061402-05, 2061402A05, 2061402B05, 2061402C05, 2061403-00, 2061403-01, 2061403-02, 2061403-03, 20614033-0, 2061403A00, 2061403A02, 2061403A03, 2061403B00, 2061403B02, 2061403B03, 2061403C00, 2061403C02, 2061403C03, 2061404-00, 2061404-01, 2061404-02, 2061404-03, 20614044-0, 2061404A00, 2061404A02, 2061404A03, 2061404B00, 2061404B02, 2061404B03, 2061404C00, 2061404C02, 2061404C03, 2061405-00, 2061405-01, 2061405-02, 2061405B00, 2061405B01, 2061405B02, 2061406-00, 2061406-01, 2061406-02, 2061406B00, 2061406B01... (Other models you can see in the webshop)		
<b>accessories for</b>	359606		
	<b>Part No.</b>	359832	<b>Ref. No.</b> —
	lamp socket mounting measurements ø16.2mm socket Ba9s connection male faston 6.3mm		
	<b>Part No.</b>	359853	<b>Ref. No.</b> —
	lamp socket mounting measurements ø18.2mm socket Ba9s connection male faston 6.3mm		

			
1			
<b>Part No.</b>	359603	<b>Ref. No.</b>	203106 359106
<b>description</b>	neon light bulb socket E14 380V clear ø 14mm L 30mm		
<b>For models:</b>	0522101-00		

## halogen lamp

## for socket G4 / G6.35 / G9

			
1			
<b>Part No.</b>	357191	<b>Ref. No.</b>	202620
<b>description</b>	halogen lamp socket G4 12V 10W temp.-resist. 300°C OSRAM HALOSTAR OVEN		
<b>For models:</b>	CCE60, CCE63, CGE11-L, CGE11-R, CGE12-L, CGE12-R, CGE21-L, CGE21-R, CGE22-L, CGE22-R, CGE61-L, CGE61-R, CGE62-L, CGE62-R, CGG11-L, CGG11-R, CGG12-L, CGG12-R, CGG21-L, CGG21-R, CGG22-L, CGG22-R, CGG61-L, CGG61-R, CGG62-L, CGG62-R, CPE60, CPE63, CSE11-L, CSE11-R, CSE11-R-DG, CSE12-L, CSE12-R, CSE12-R-DG, CSE21-L, CSE21-R, CSE21-R-DG, CSE22-L, CSE22-R, CSE22-R-DG, CSE61-L, CSE61-R, CSE61-R-DG, CSE62-L, CSE62-R, CSE62-R-DG, CSG11-L, CSG11-R, CSG11-R-DG, CSG12-L... (Other models you can see in the webshop)		


			
1			
<b>Part No.</b>	359599	<b>Ref. No.</b>	203679
<b>description</b>	halogen lamp socket G4 12V 20W temp.-resist. 500°C		
<b>For models:</b>	CCE60, CCE63, CGE11-L, CGE11-R, CGE12-L, CGE12-R, CGE21-L, CGE21-R, CGE22-L, CGE22-R, CGE61-L, CGE61-R, CGE62-L, CGE62-R, CGG11-L, CGG11-R, CGG12-L, CGG12-R, CGG21-L, CGG21-R, CGG22-L, CGG22-R, CGG61-L, CGG61-R, CGG62-L, CGG62-R, CPE60, CPE63, CSE11-L, CSE11-R, CSE11-R-DG, CSE12-L, CSE12-R, CSE12-R-DG, CSE21-L, CSE21-R, CSE21-R-DG, CSE22-L, CSE22-R, CSE22-R-DG, CSE61-L, CSE61-R, CSE61-R-DG, CSE62-L, CSE62-R, CSE62-R-DG, CSG11-L, CSG11-R, CSG11-R-DG, CSG12-L... (Other models you can see in the webshop)		



oven lamps


producer-specific oven lamps

MKN




1

<b>Part No.</b>	693050	<b>Ref. No.</b>	211128	
<b>description</b>	gasket graphite D1 ø 71mm D2 ø 94mm thickness 1mm suitable for MKN Qty 1 pcs			
<b>For models:</b>	CGE11-L, CGE11-R, CGE12-L, CGE12-R, CGE21-L, CGE21-R, CGE22-L, CGE22-R, CGE61-L, CGE61-R, CGE62-L, CGE62-R, CGG11-L, CGG11-R, CGG12-L, CGG12-R, CGG21-L, CGG21-R, CGG22-L, CGG22-R, CGG61-L, CGG61-R, CGG62-L, CGG62-R, CSE11-L, CSE11-R, CSE11-R-DG, CSE12-L, CSE12-R, CSE12-R-DG, CSE21-L, CSE21-R, CSE21-R-DG, CSE22-L, CSE22-R, CSE22-R-DG, CSE61-L, CSE61-R, CSE61-R-DG, CSE62-L, CSE62-R, CSE62-R-DG, CSG11-L, CSG11-R, CSG11-R-DG, CSG12-L, CSG12-R, CSG12-R-DG, CSG21-L, CSG21-R...(Other models you can see in the webshop)			
<b>accessories for</b>	693050			
	<b>Part No.</b>	694294	<b>Ref. No.</b>	216115
	glass panel ø 90mm thickness 8mm			



1


<b>Part No.</b>	699482	<b>Ref. No.</b>	211146	
<b>description</b>	gasket suitable for MKN combi-steamer mounting pos. for lens ED ø 105mm ID ø 71mm graphite thickness 1mm			
<b>For models:</b>	CGE21-L, CGE21-R, CGE22-L, CGE22-R, CGG21-L, CGG21-R, CGG22-L, CGG22-R, CSE11-L, CSE11-R, CSE11-R-DG, CSE12-L, CSE12-R, CSE12-R-DG, CSE21-L, CSE21-R, CSE21-R-DG, CSE22-L, CSE22-R, CSE22-R-DG, CSE61-L, CSE61-R, CSE61-R-DG, CSE62-L, CSE62-R, CSE62-R-DG, CSG11-L, CSG11-R, CSG11-R-DG, CSG12-L, CSG12-R, CSG12-R-DG, CSG21-L, CSG21-R, CSG21-R-DG, CSG22-L, CSG22-R, CSG22-R-DG, CSG61-L, CSG61-R, CSG61-R-DG, CSG62-L, CSG62-R, CSG62-R-DG			
<b>accessories for</b>	699482			
	<b>Part No.</b>	694294	<b>Ref. No.</b>	216115
	glass panel ø 90mm thickness 8mm			



1

<b>Part No.</b>	694294	<b>Ref. No.</b>	216115	
<b>description</b>	glass panel ø 90mm thickness 8mm			
<b>For models:</b>	CGE11-L, CGE11-R, CGE12-L, CGE12-R, CGE21-L, CGE21-R, CGE22-L, CGE22-R, CGE61-L, CGE61-R, CGE62-L, CGE62-R, CGG11-L, CGG11-R, CGG12-L, CGG12-R, CGG21-L, CGG21-R, CGG22-L, CGG22-R, CGG61-L, CGG61-R, CGG62-L, CGG62-R, CSE11-L, CSE11-R, CSE11-R-DG, CSE12-L, CSE12-R, CSE12-R-DG, CSE21-L, CSE21-R, CSE21-R-DG, CSE22-L, CSE22-R, CSE22-R-DG, CSE61-L, CSE61-R, CSE61-R-DG, CSE62-L, CSE62-R, CSE62-R-DG, CSG11-L, CSG11-R, CSG11-R-DG, CSG12-L, CSG12-R, CSG12-R-DG, CSG21-L, CSG21-R...(Other models you can see in the webshop)			
<b>accessories for</b>	694294			
	<b>Part No.</b>	693050	<b>Ref. No.</b>	211128
	gasket graphite D1 ø 71mm D2 ø 94mm thickness 1mm suitable for MKN Qty 1 pcs			


<b>accessories for</b>	694294			
	<b>Part No.</b>	699482	<b>Ref. No.</b>	211146
	gasket suitable for MKN combi-steamer mounting pos. for lens ED ø 105mm ID ø 71mm graphite thickness 1mm			



1


<b>Part No.</b>	357184	<b>Ref. No.</b>	203678
<b>description</b>	lamp socket socket G4 cable length 130mm connection male faston 6.3mm ø 17mm H 9mm mounting distance 12mm mounting thread M3 Qty 1 pcs		
<b>For models:</b>	CCE60, CCE63, CGE11-L, CGE11-R, CGE12-L, CGE12-R, CGE21-L, CGE21-R, CGE22-L, CGE22-R, CGE61-L, CGE61-R, CGE62-L, CGE62-R, CGG11-L, CGG11-R, CGG12-L, CGG12-R, CGG21-L, CGG21-R, CGG22-L, CGG22-R, CGG61-L, CGG61-R, CGG62-L, CGG62-R, CPE60, CPE63, CSE11-L, CSE11-R, CSE11-R-DG, CSE12-L, CSE12-R, CSE12-R-DG, CSE21-L, CSE21-R, CSE21-R-DG, CSE22-L, CSE22-R, CSE22-R-DG, CSE61-L, CSE61-R, CSE61-R-DG, CSE62-L, CSE62-R, CSE62-R-DG, CSG11-L, CSG11-R, CSG11-R-DG, CSG12-L...(Other models you can see in the webshop)		

lamps  
halogen lamps  
for socket G4 / G6.35 / G9



1

<b>Part No.</b>	357191	<b>Ref. No.</b>	202620
<b>description</b>	halogen lamp socket G4 12V 10W temp.-resist. 300°C OSRAM HALOSTAR OVEN		
<b>For models:</b>	CCE60, CCE63, CGE11-L, CGE11-R, CGE12-L, CGE12-R, CGE21-L, CGE21-R, CGE22-L, CGE22-R, CGE61-L, CGE61-R, CGE62-L, CGE62-R, CGG11-L, CGG11-R, CGG12-L, CGG12-R, CGG21-L, CGG21-R, CGG22-L, CGG22-R, CGG61-L, CGG61-R, CGG62-L, CGG62-R, CPE60, CPE63, CSE11-L, CSE11-R, CSE11-R-DG, CSE12-L, CSE12-R, CSE12-R-DG, CSE21-L, CSE21-R, CSE21-R-DG, CSE22-L, CSE22-R, CSE22-R-DG, CSE61-L, CSE61-R, CSE61-R-DG, CSE62-L, CSE62-R, CSE62-R-DG, CSG11-L, CSG11-R, CSG11-R-DG, CSG12-L...(Other models you can see in the webshop)		



1

<b>Part No.</b>	359599	<b>Ref. No.</b>	203679
<b>description</b>	halogen lamp socket G4 12V 20W temp.-resist. 500°C		
<b>For models:</b>	CCE60, CCE63, CGE11-L, CGE11-R, CGE12-L, CGE12-R, CGE21-L, CGE21-R, CGE22-L, CGE22-R, CGE61-L, CGE61-R, CGE62-L, CGE62-R, CGG11-L, CGG11-R, CGG12-L, CGG12-R, CGG21-L, CGG21-R, CGG22-L, CGG22-R, CGG61-L, CGG61-R, CGG62-L, CGG62-R, CPE60, CPE63, CSE11-L, CSE11-R, CSE11-R-DG, CSE12-L, CSE12-R, CSE12-R-DG, CSE21-L, CSE21-R, CSE21-R-DG, CSE22-L, CSE22-R, CSE22-R-DG, CSE61-L, CSE61-R, CSE61-R-DG, CSE62-L, CSE62-R, CSE62-R-DG, CSG11-L, CSG11-R, CSG11-R-DG, CSG12-L...(Other models you can see in the webshop)		



## timers

## digital timers



1

<b>Part No.</b>	381461	<b>Ref. No.</b>	203383
<b>description</b>	digital switch clock STÖRK-TRONIK ST64-31.07HF time range 0-999h 230 16A 1NO mounting measurements 60mm display 3 digits built-in depth 62mm		
<b>For models:</b>	2021115-00, 2021115-01, 2021115-02, 2021115-03, 2021115-04, 2221115-00, 2221115-01		



1

<b>Part No.</b>	360347	<b>Ref. No.</b>	203237 845436
<b>description</b>	timer electronic 15min		
<b>For models:</b>	0220302A03, 0220302C03, 0220302H01, 0220303A03, 0220303C02, 0220303H01		



1

<b>Part No.</b>	360348	<b>Ref. No.</b>	203324
<b>description</b>	timer electronic 15min		
<b>For models:</b>	0220302A03, 0220302C03, 0220302H01, 0220303A03, 0220303C02, 0220303H01, 1220303A00, 1220303A01, 1220303A02, 1220303A03, 1220303C00, 1220303C01, 1220303C02, 1220303C03, 1220303F01, 1220303F02, 1220303F03, 1220303H00, 1220303H01, 1220303H02, 1220303H03, 1220305A00, 1220305A01, 1220305A02, 1220305A03, 1220305A04, 1220305A05, 1220305C00, 1220305C01, 1220305C02, 1220305C03, 1220305C04, 1220305C05, 1220305F01, 1220305F02, 1220305F03, 1220305F04, 1220305F05, 1220305H00, 1220305H01, 1220305H02, 1220305H03, 1220305H04, 1220305H05, 1320303A00, 1320303A01, 1320303A02, 1320303C00, 1320303C01, 1320303C02... (Other models you can see in the webshop)		

## alarm devices

## buzzers



1

<b>Part No.</b>	350050	<b>Ref. No.</b>	203325
<b>description</b>	buzzer 230VAC connection male faston 6.3mm screw mounting thread M4 60dB		
<b>For models:</b>	0220302A00, 0220302A01, 0220302C00, 0220302C01, 0220303A00, 0220303A01, 0220303C00, 0220304-00, 0220305-00, 0220306-00, 0720332P00, 0720332R00, 0720332T00, 0720332V00, 1420332P01, 1420332P02, 1420332P03, 1420332R00, 1420332R01, 1420332R02, 1420332R03, 1420332T01, 1420332T02, 1420332T03, 1420332V01, 1420332V02, 1420332V03, 1420333P01, 1420333P02, 1420333R00, 1420333R01, 1420333R02, 1420333T01, 1420333T02, 1420333V01, 1420333V02, 1420334P00, 1420334P01, 1420334P02, 1420334P03, 1420334P04, 1420334R02, 1420334R03, 1420334R04, 1420334T02, 1420334T03, 1420334T04, 1420334V01, 1420334V02, 1420334V03... (Other models you can see in the webshop)		



1

<b>Part No.</b>	350221	<b>Ref. No.</b>	202775
<b>description</b>	buzzer 5-28VDC connection F6.3 mounting ø 40mm		
<b>For models:</b>	CSE61-L, CSE61-R, CSE61-R-DG, CSE62-L, CSE62-R, CSE62-R-DG		

## contactors

## MOELLER/EATON

## power contactors




1


<b>Part No.</b>	380492	<b>Ref. No.</b>	203203
<b>description</b>	contactor resistive load 35A 230VAC main contacts 3NO		
<b>For models:</b>	0220302H00, 0220302H01, 0220303B01, 0220303C01, 0220303C02, 0220303E01, 0220303H00, 0220303H01, 0723105-03, 0723105A03, 0723105B03, 1220305B02, 1220305B03, 1220305B04, 1220305C00, 1220305C01, 1220305C02, 1220305C03, 1220305C04, 1220305E00, 1220305E01, 1220305E02, 1220305E03, 1220305E04, 1220305E05, 1220305H00, 1220305H01, 1220305H02, 1220305H03, 1220305H04, 1220305H05, 1220305K00, 1220330B00, 1220330B01, 1320305B02, 1320305B03, 1320305C00, 1320305C01, 1320305C02, 1320305C03, 1320305E00, 1320305E01, 1320305E02, 1320305E03, 1320305E04, 1320305E05, 1320305H00, 1320305H01, 1320305H02, 1320305H03... (Other models you can see in the webshop)		








			
1			
<b>Part No.</b>	381486	<b>Ref. No.</b>	203971
<b>description</b>	power contactor resistive load 20A (AC3/400V) 4kW main contacts 2x3NO auxiliary contacts 2x1NO connection screw type LC2K0910P7		
<b>For models:</b>	CGE11-L, CGE11-R, CGE21-L, CGE21-R, CGE61-L, CGE61-R, CPE63, CSE11-L, CSE11-R, CSE11-R-DG, CSE12-L, CSE12-R, CSE12-R-DG, CSE21-L, CSE21-R, CSE21-R-DG, CSE22-L, CSE22-R, CSE22-R-DG, CSE61-L, CSE61-R, CSE61-R-DG, CSE62-L, CSE62-R, CSE62-R-DG		

			
1			
<b>Part No.</b>	380965	<b>Ref. No.</b>	203744
<b>description</b>	power contactor resistive load 20A 230VAC (AC3/400V) 6A/2.2kW main contacts 3NO auxiliary contacts 1NO connection screw connection type LC1K0610P7+		
<b>For models:</b>	0720325-03, 0720325-04, 0720325B03, 0720325B04, 0721134-01, 0721134A01, 1022603-00, 1220327-00, 1220327-01, 1220327B01, 1220329-00, 1220329-01, 1220402-00, 1220402-01, 1221103-04, 1221103B04, 1221130J00, 1221135A04, 1221135J00, 1221136A04, 1221141-00, 1221141A00, 1222507-00, 1222509-00, 1222603-00, 1320323-00, 1320323B00, 1320327-00, 1320327A00, 1320327A01, 1320327A02, 1320327B00, 1320327C00, 1320327C01, 1320327C02, 1320329-00, 1320329-01, 1320329A00, 1320329A01, 1320329A02, 1320335C00, 1320402-00, 1320402-01, 1321130-00, 1321130A00, 1321131-00, 1321131A00, 1321135A03, 1321136A03, 1321141-00... (Other models you can see in the webshop)		

			
1			
<b>Part No.</b>	380479	<b>Ref. No.</b>	203676
<b>description</b>	power contactor resistive load 25A 230VAC (AC3/400V) 9A/4kW main contacts 3NO auxiliary contacts 1NO/1NC connection screw connection type LC1D09P7		
<b>For models:</b>	CGE11-L, CGE11-R, CGE21-L, CGE21-R, CGE61-L, CGE61-R, CSE11-L, CSE11-R, CSE21-L, CSE21-R, CSE61-L, CSE61-R		

			
1			
<b>Part No.</b>	380976	<b>Ref. No.</b>	203675
<b>description</b>	power contactor resistive load 32A 230VAC (AC3/400V) 18A/7.5kW main contacts 3NO auxiliary contacts 1NO/1NC connection screw connection		
<b>For models:</b>	0720332P00, 0720332R00, 0720332T00, 0720332V00, 1220305B05, 1220305B06, 1220305B07, 1220305K01, 1220305K02, 1220305K03, 1220329B00, 1220329B01, 1320329B00, 1320329B01, 1320329C00, 1320329C01, 1320329C02, 1420329B00, 1420329B01, 1420329C00, 1420329C01, 1420332P01, 1420332P02, 1420332P03, 1420332R00, 1420332R01, 1420332R02, 1420332R03, 1420332T01, 1420332T02, 1420332T03, 1420332V01, 1420332V02, 1420332V03, 1420333P01, 1420333P02, 1420333R00, 1420333R01, 1420333R02, 1420333T01, 1420333T02, 1420333V01, 1420333V02, 1420334P00, 1420334P01, 1420334P02, 1420334P03, 1420334P04, 1420334R02, 1420334R03... (Other models you can see in the webshop)		

			
1			
<b>Part No.</b>	380980	<b>Ref. No.</b>	203985
<b>description</b>	power contactor resistive load 50A 230VAC (AC3/400V) 32A/15kW main contacts 3NO auxiliary contacts 1NO/1NC connection screw connection type LC1D32P7		
<b>For models:</b>	1420334T02, 1420334T03, 1420334T04, 1420334V01, 1420334V02, 1420334V03, 1420334V04, 1420334W02, 1420334W03, 1420334W04, 1420334Y02, 1420334Y03, 1420334Y04, 1520334T03, 1520334T04, 1520334T05, 1520334V02, 1520334V03, 1520334V04, 1520334V05, 1520334W03, 1520334W04, 1520334W05, 1520334Y03, 1520334Y04, 1520334Y05, 2020334T00, 2020334T01, 2020334V00, 2020334V01, 2020346V00, 2020349V00, 2020349V01, 2020349V02, 2020349V03, 2022909-02, 2220334T00, 2220334T01, 2220334T02, 2220334T03, 2220334T04, 2220334V01, 2220334V02, 2220334V03, 2220334V04, 2420334T00, 2420334T01, 2420334T02, 2420334T03, 2420334V00... (Other models you can see in the webshop)		



TRIPUS (Eichhoff)

small relay switches



1			
<b>Part No.</b>	380121	<b>Ref. No.</b>	203219
<b>description</b>	small relay switch 230V main contacts 3NO/1NC auxiliary contacts knob ø70mm (227-piece) connection Faston 6.3mm type E3250 resistive load 16A		
<b>For models:</b>	0221501-00, 0221502-00, 1421501-00, 1421502-00, 1421503-00, 1421504-00, 2121501-00, 2121502-00		

miscellaneous

accessories



1			
<b>Part No.</b>	550875	<b>Ref. No.</b>	203225
<b>description</b>	jumper for auxiliary contact		
<b>For models:</b>	0120101-01, 0120101-02, 0120101-03, 0120101-04, 0120101D00, 0120101D01, 0120101D02, 0120101D04, 0120105-01, 0120105-02, 0120105-03, 0120105-04, 0120105D00, 0120105D01, 0120105D02, 0120105D04, 0520302-01, 0520302-02, 0520302A00, 0520302A01, 1320401-01, 1420401-01, 1422804B04, 1422804B05, 1422804B06, 1422804B07, 1422804B08, 1422805B04, 1422805B05, 1422805B06, 1422805B07, 1422805B08, 1422807B00, 1422807B01, 1422807B02, 1422807B03, 1422807B04, 1422902-00, 1422902-01, 1422902-02, 1422902-03, 1422902-04, 2020401-01, 2021115-00, 2021115-01, 2021115-02, 2021115-03, 2021115-04, 2022804B04, 2022804B05... (Other models you can see in the webshop)		

power contactors



1			
<b>Part No.</b>	380165	<b>Ref. No.</b>	203423
<b>description</b>	power contactor		
<b>For models:</b>	1422701-00, 1422702-00, 1422802B04, 1422802B05, 1422802B06, 1422802B07, 1422802B08, 1422804B04, 1422804B05, 1422804B06, 1422804B07, 1422804B08, 1422805B04, 1422805B05, 1422805B06, 1422805B07, 1422805B08, 1422807B00, 1422807B01, 1422807B02, 1422807B03, 1422807B04, 1422831-00, 1422832-00, 1422833-00, 1422834-00, 1422902-00, 1422902-01, 1422902-02, 1422902-03, 1422902-04, 1422908-00, 1422910-00, 1423901-00, 1423901-01, 1423901-02, 1423902-00, 1423902-01, 1423902-02, 1423903-00, 1423903-01, 1423903-02, 2020308-00, 2021123A00, 2021411-00, 2021412C00, 2021413-00, 2021413B00, 2021414C00, 2021417-00... (Other models you can see in the webshop)		

solid state relays

CROUZET



1			
<b>Part No.</b>	403534	<b>Ref. No.</b>	203668
<b>description</b>	solid state relay CROUZET 1 phase 100A 48-660V 4-32VDC L 58mm W 49mm new edition screw type 84137140		
<b>For models:</b>	CCE60, CCE63, CGE11-L, CGE11-R, CGE12-L, CGE12-R, CGE21-L, CGE21-R, CGE22-L, CGE22-R, CGE61-L, CGE61-R, CGE62-L, CGE62-R, CPE60, CPE63, CSE11-L, CSE11-R, CSE11-R-DG, CSE12-L, CSE12-R, CSE12-R-DG, CSE21-L, CSE21-R, CSE21-R-DG, CSE22-L, CSE22-R, CSE22-R-DG, CSE61-L, CSE61-R, CSE61-R-DG, CSE62-L, CSE62-R, CSE62-R-DG		



1			
<b>Part No.</b>	403535	<b>Ref. No.</b>	203669
<b>description</b>	solid state relay CROUZET 1 phase 10A 24-280V 90-280VAC L 58mm W 49mm new edition screw type 84137001		
<b>For models:</b>	CGE11-L, CGE11-R, CGE12-L, CGE12-R, CGE21-L, CGE21-R, CGE22-L, CGE22-R, CGE61-L, CGE61-R, CGE62-L, CGE62-R, CGG11-L, CGG11-R, CGG12-L, CGG12-R, CGG21-L, CGG21-R, CGG22-L, CGG22-R, CGG61-L, CGG61-R, CGG62-L, CGG62-R, CSE11-L, CSE11-R, CSE12-L, CSE12-R, CSE21-L, CSE21-R, CSE22-L, CSE22-R, CSE61-L, CSE61-R, CSE62-L, CSE62-R, CSG11-L, CSG11-R, CSG11-R-DG, CSG12-L, CSG12-R, CSG12-R-DG, CSG21-L, CSG21-R, CSG22-L, CSG22-R, CSG61-L, CSG61-R		

heat-conducting foils



1			
<b>Part No.</b>	401676	<b>Ref. No.</b>	203671
<b>description</b>	heat-conducting foil L 57mm W 45mm		
<b>For models:</b>	CGE11-L, CGE11-R, CGE12-L, CGE12-R, CGE21-L, CGE21-R, CGE22-L, CGE22-R, CGE61-L, CGE61-R, CGE62-L, CGE62-R, CGG11-L, CGG11-R, CGG12-L, CGG12-R, CGG21-L, CGG21-R, CGG22-L, CGG22-R, CGG61-L, CGG61-R, CGG62-L, CGG62-R, CPE63, CSE11-L, CSE11-R, CSE11-R-DG, CSE12-L, CSE12-R, CSE21-L, CSE21-R, CSE22-L, CSE22-R, CSE61-L, CSE61-R, CSE61-R-DG, CSE62-L, CSE62-R, CSG11-L, CSG11-R, CSG12-L, CSG12-R, CSG21-L, CSG21-R, CSG22-L, CSG22-R, CSG61-L, CSG61-R		



## relays

## flasher relays



1

Part No.	380392	Ref. No.	203308
description	flasher relay 230V		
For models:	0220302A00, 0220302A01, 0220302A02, 0220302A03, 0220302C00, 0220302C01, 0220302C02, 0220302C03, 0220302H00, 0220302H01, 0220303A00, 0220303A01, 0220303A02, 0220303A03, 0220303C00, 0220303C01, 0220303C02, 0220304-00, 0220305-00, 0220306-00, 1220303A00, 1220303A01, 1220303A02, 1220303C00, 1220303C01, 1220303C02, 1220303F01, 1220303F02, 1220303H00, 1220303H01, 1220303H02, 1220305A00, 1220305A01, 1220305A02, 1220305A03, 1220305C00, 1220305C01, 1220305C02, 1220305C03, 1220305F01, 1220305F02, 1220305F03, 1220305H00, 1220305H01, 1220305H02, 1220305H03, 1320303A00, 1320303A01, 1320303A02, 1320303C00... (Other models you can see in the webshop)		

## power relays

## with special fixing



1

Part No.	380441	Ref. No.	202732
description	power relays SCHRACK 230VAC 16A 2NO connection coded plug manuf. no. 0419 110301 00 2-pole		
For models:	0521702B03, 0521702B04, 0521704-07, 1221134A01		

## level relays

## GICAR



1

Part No.	400017	Ref. No.	203063
description	level relay 230V voltage AC 50/60Hz 11-pole 50/60A connection plug-in connection round 11-pole type RL30/1E/2C/11		

## miscellaneous



1

Part No.	380495	Ref. No.	203419
description	level relay 220-240V type RM4 LA32M		
For models:	1422802B04, 1422802B05, 1422802B06, 1422802B07, 1422802B08, 1422804B04, 1422804B05, 1422804B06, 1422804B07, 1422804B08, 1422805B04, 1422805B05, 1422805B06, 1422805B07, 1422805B08, 1422807B00, 1422807B01, 1422807B02, 1422807B03, 1422807B04, 1422902-00, 1422902-01, 1422902-02, 1422902-03, 1422902-04, 1462802B00, 1462802B01, 1462802B02, 1462802B03, 1462802B04, 1462802B05, 1462804B00, 1462804B01, 1462804B02, 1462804B03, 1462804B04, 1462804B05, 1462831-00, 1462832-00, 1462835-00, 1462836-00, 1462837-00, 1462908-00, 2022802B04, 2022802B05, 2022802B06, 2022802B07, 2022802B08, 2022802B09, 2022802B10... (Other models you can see in the webshop)		



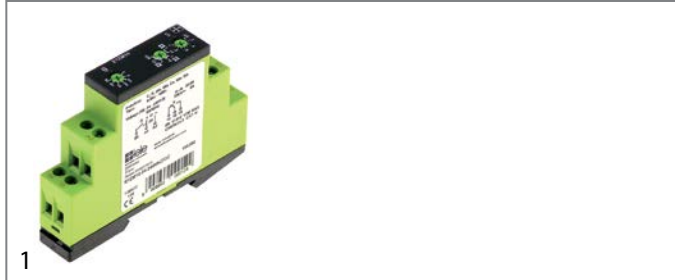
1

Part No.	400068	Ref. No.	203175
description	level relay 230V voltage AC type 75.03000.050		
For models:	2022801-02, 2022801-03, 2022801A02, 2022801A03, 2022801B02, 2022801B03, 2022801C02, 2022801C03, 2022802-02, 2022802-03, 2022802A02, 2022802A03, 2022802B02, 2022802B03, 2022802C02, 2022802C03, 2022803-02, 2022803-03, 2022803A02, 2022803A03, 2022803B02, 2022803B03, 2022803C02, 2022803C03, 2022804-02, 2022804-03, 2022804A02, 2022804A03, 2022804B02, 2022804B03, 2022804C02, 2022804C03, 2022805-02, 2022805-03, 2022805A02, 2022805A03, 2022805B02, 2022805B03, 2022805C02, 2022805C03, 2062801-01, 2062801-02, 2062801-03, 2062801-04, 2062801-05, 2062801-06, 2062801A01, 2062801A02, 2062801A03, 2062801A04... (Other models you can see in the webshop)		



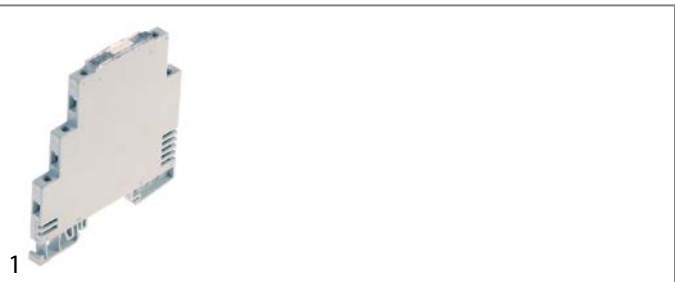
time relays

time relays



1			
<b>Part No.</b>	381092	<b>Ref. No.</b>	203437
<b>description</b>	time relay 0.05s-100h		
<b>For models:</b>	1462802B01, 1462802B02, 1462802B03, 1462802B04, 1462802B05, 1462804B01, 1462804B02, 1462804B03, 1462804B04, 1462804B05, 2012828-00, 2012828-01, 2012828-02, 2012828-03, 2012828-04, 2012828-05, 2012829-00, 2012829-01, 2012829-02, 2022828-01, 2022828-02, 2022828-03, 2022828-04, 2022828-05, 2022828-06, 2023003B01, 2023003B02, 2023003B03, 2023003B04, 2023003B05, 2023003B06, 2023003B07, 2023004B01, 2023004B02, 2023004B03, 2023004B04, 2023004B05, 2023004B06, 2023004B07, 2023007B01, 2023007B02, 2023007B03, 2023007B04, 2023007B05, 2023007B06, 2023007B07, 2023008B01, 2023008B02, 2023008B03, 2023008B04... (Other models you can see in the webshop)		

miscellaneous



1			
<b>Part No.</b>	381093	<b>Ref. No.</b>	203753
<b>description</b>	power relays 1CO 230V voltage AC/DC 0.0001-6A connection screw clamp DIN rail		
<b>For models:</b>	0720332P00, 0720332R00, 0720332T00, 0720332V00, 1420332P01, 1420332P02, 1420332P03, 1420332R00, 1420332R01, 1420332R02, 1420332R03, 1420332T01, 1420332T02, 1420332T03, 1420332V01, 1420332V02, 1420332V03, 1420333P01, 1420333P02, 1420333R00, 1420333R01, 1420333R02, 1420333T01, 1420333T02, 1420333V01, 1420333V02, 1420334P00, 1420334P01, 1420334P02, 1420334P03, 1420334P04, 1420334R02, 1420334R03, 1420334R04, 1420334T02, 1420334T03, 1420334T04, 1420334V01, 1420334V02, 1420334V03, 1420334V04, 1420334W02, 1420334W03, 1420334W04, 1420334Y02, 1420334Y03, 1420334Y04, 1420344R00, 1420344R01, 1420344R02... (Other models you can see in the webshop)		



1			
<b>Part No.</b>	381465	<b>Ref. No.</b>	203735
<b>description</b>	remote control module 440V capacity 47nF 3x2MOhm DIN rail		
<b>For models:</b>	CCE60, CCE63, CGE11-L, CGE11-R, CGE12-L, CGE12-R, CGE21-L, CGE21-R, CGE22-L, CGE22-R, CGE61-L, CGE61-R, CGE62-L, CGE62-R, CGG11-L, CGG11-R, CGG12-L, CGG12-R, CGG61-L, CGG61-R, CGG62-L, CGG62-R, CPE60, CPE63, CSE11-L, CSE11-R, CSE11-R-DG, CSE12-L, CSE12-R, CSE12-R-DG, CSE21-L, CSE21-R, CSE21-R-DG, CSE22-L, CSE22-R, CSE22-R-DG, CSE61-L, CSE61-R, CSE61-R-DG, CSE62-L, CSE62-R, CSE62-R-DG, CSG11-L, CSG11-R, CSG11-R-DG, CSG12-L, CSG12-R, CSG12-R-DG, CSG21-L, CSG21-R... (Other models you can see in the webshop)		

transformers

open transformers

with clamp terminal



1			
<b>Part No.</b>	403900	<b>Ref. No.</b>	202604
<b>description</b>	control transformer primary 208-600VAC secondary 2x115VAC 460VA secondary 2A H 133mm L 150mm W 112mm 50/60Hz type EI 150N/49/F		
<b>For models:</b>	CSE61-L, CSE61-R, CSE61-R-DG, CSE62-L, CSE62-R, CSE62-R-DG		





1			
<b>Part No.</b>	403875	<b>Ref. No.</b>	10015147
<b>description</b>	transformer 750VA H 143mm L 110mm W 150mm connection grip connection 50-60Hz		





1			
<b>Part No.</b>	403303	<b>Ref. No.</b>	202608 202608+202725
<b>description</b>	transformer primary 110-250VAC secondary 230VAC 100VA connection plug 50/60Hz		
<b>For models:</b>	CGE11-L, CGE11-R, CGE12-L, CGE12-R, CGE21-L, CGE21-R, CGE22-L, CGE22-R, CGE61-L, CGE61-R, CGE62-L, CGE62-R, CGG11-L, CGG11-R, CGG12-L, CGG12-R, CGG21-L, CGG21-R, CGG22-L, CGG22-R, CGG61-L, CGG61-R, CGG62-L, CGG62-R, CSE11-L, CSE11-R, CSE11-R-DG, CSE12-L, CSE12-R, CSE12-R-DG, CSE21-L, CSE21-R, CSE21-R-DG, CSE22-L, CSE22-R, CSE22-R-DG, CSE61-L, CSE61-R, CSE61-R-DG, CSE62-L, CSE62-R, CSE62-R-DG, CSG11-L, CSG11-R, CSG11-R-DG, CSG12-L, CSG12-R, CSG12-R-DG, CSG21-L, CSG21-R... (Other models you can see in the webshop)		




			
1			
<b>Part No.</b>	400791	<b>Ref. No.</b>	203999
<b>description</b>	transformer primary 120/200/220/230V secondary 24V 108VA 50/60Hz		
<b>For models:</b>	CGG11-L, CGG11-R, CGG12-L, CGG12-R, CGG21-L, CGG21-R, CGG22-L, CGG22-R, CGG61-L, CGG61-R, CGG62-L, CGG62-R, CSG11-L, CSG11-R, CSG11-R-DG, CSG12-L, CSG12-R, CSG12-R-DG, CSG21-L, CSG21-R, CSG21-R-DG, CSG22-L, CSG22-R, CSG22-R-DG, CSG61-L, CSG61-R, CSG61-R-DG, CSG62-L, CSG62-R, CSG62-R-DG		

			
1			
<b>Part No.</b>	400792	<b>Ref. No.</b>	203818
<b>description</b>	transformer primary 200/208/220/230/240/250V secondary 4.2/10.7/21V 162VA 50/60Hz		
<b>For models:</b>	815166, CGE11-L, CGE11-R, CGE12-L, CGE12-R, CGE21-L, CGE21-R, CGE22-L, CGE22-R, CGE61-L, CGE61-R, CGE62-L, CGE62-R, CGG11-L, CGG11-R, CGG12-L, CGG12-R, CGG21-L, CGG21-R, CGG22-L, CGG22-R, CGG61-L, CGG61-R, CGG62-L, CGG62-R, CPE63, CSE11-L, CSE11-R, CSE11-R-DG, CSE12-L, CSE12-R, CSE12-R-DG, CSE21-L, CSE21-R, CSE21-R-DG, CSE22-L, CSE22-R, CSE22-R-DG, CSE61-L, CSE61-R, CSE61-R-DG, CSE62-L, CSE62-R, CSE62-R-DG, CSG11-L, CSG11-R, CSG11-R-DG, CSG12-L, CSG12-R, CSG12-R-DG...(Other models you can see in the webshop)		


			
1			
<b>Part No.</b>	403305	<b>Ref. No.</b>	203670
<b>description</b>	transformer primary 200-250VAC secondary 215/230VAC 92VA connection plug 50/60Hz		
<b>For models:</b>	CGE11-L, CGE11-R, CGE12-L, CGE12-R, CGE22-L, CGE22-R, CGE61-L, CGE61-R, CPE63, CSE11-L, CSE11-R, CSE12-L, CSE12-R, CSE22-L, CSE22-R, CSE61-L, CSE61-R		

			
1			
<b>Part No.</b>	403304	<b>Ref. No.</b>	203980 203981
<b>description</b>	transformer primary 440VAC secondary 230VAC 500VA connection screw clamp 50/60Hz		
<b>For models:</b>	CGE11-L, CGE11-R, CGE22-L, CGE22-R, CGE61-L, CGE61-R, CSE11-L, CSE11-R, CSE22-L, CSE22-R, CSE61-L, CSE61-R		

## with plug connection

			
1			
<b>Part No.</b>	403845	<b>Ref. No.</b>	10013658
<b>description</b>	transformer primary 110-250VAC secondary 18VAC 100VA H 103mm L 80mm W 100mm connection plug 50/60Hz for combi-steamer		


## for lighting

			
1			
<b>Part No.</b>	403306	<b>Ref. No.</b>	203749
<b>description</b>	transformer primary 230VAC secondary 11.5VAC 50VA secondary 4A connection screw L 165mm W 45mm H 37mm 50/60Hz mounting distance 155mm for lighting		
<b>For models:</b>	CGE11-L, CGE11-R, CGE22-L, CGE22-R, CGE61-L, CGE61-R, CPE63, CSE11-L, CSE11-R, CSE22-L, CSE22-R, CSE61-L, CSE61-R		

## probes

## producer-specific probes

## probes

			
1			
<b>Part No.</b>	379997	<b>Ref. No.</b>	203602
<b>description</b>	temperature probe thermocouple J (Fe-CuNi) cable PTFE probe -50 up to +750°C cable -40 up to +250°C connection 2-wire thread M10x1 probe ø6x80/180mm cable length 1.4m		
<b>For models:</b>	1220302-00, 1220302-01, 1220302B00, 1220302B01, 1220302D00, 1220302E00, 1220304-00, 1220304-01, 1220304A00, 1220304A01, 1220304A02, 1220304B00, 1220304B01, 1220304C00, 1220304C01, 1220304C02, 1220304D00, 1220304E00, 1220304F00, 1220304F01, 1220304H00, 1220304H01, 1220306-00, 1220306-01, 1220306A00, 1220306A01, 1220306A02, 1220306A03, 1220306A04, 1220306B00, 1220306B01, 1220306C00, 1220306C01, 1220306C02, 1220306C03, 1220306C04, 1220306D00, 1220306E00, 1220306F00, 1220306F01, 1220306F02, 1220306F03, 1220306H00, 1220306H01, 1220306H02, 1220306H03, 1320302-00, 1320302-01, 1320302B00, 1320302B01... (Other models you can see in the webshop)		





<b>Part No.</b>	378120	<b>Ref. No.</b>	203991
<b>description</b>	temperature probe thermocouple K (NiCr-Ni) cable PTFE probe -50 up to 1150°C cable -40 up to +250°C connection 2-wire thread M8x1 probe ø1.5x18mm cable length 1.6m		
<b>For models:</b>	CGE11-L, CGE11-R, CGE12-L, CGE12-R, CGE21-L, CGE21-R, CGE22-L, CGE22-R, CGE61-L, CGE61-R, CGE62-L, CGE62-R, CGG11-L, CGG11-R, CGG12-L, CGG12-R, CGG21-L, CGG21-R, CGG22-L, CGG22-R, CGG61-L, CGG61-R, CGG62-L, CGG62-R, CPE63, CSE11-L, CSE11-R, CSE22-L, CSE22-R, CSE61-L, CSE61-R		

<b>Part No.</b>	378121	<b>Ref. No.</b>	203689
<b>description</b>	temperature probe thermocouple K (NiCr-Ni) cable PTFE probe -50 up to 1150°C cable -40 up to +250°C connection 2-wire thread M8x1 probe ø1.5x18mm cable length 3.2m		
<b>For models:</b>	CCE60, CCE63, CGE11-L, CGE11-R, CGE12-L, CGE12-R, CGE21-L, CGE21-R, CGE22-L, CGE22-R, CGE61-L, CGE61-R, CGE62-L, CGE62-R, CGG11-L, CGG11-R, CGG12-L, CGG12-R, CGG21-L, CGG21-R, CGG22-L, CGG22-R, CGG61-L, CGG61-R, CGG62-L, CGG62-R, CPE60, CPE63, CSE11-L, CSE11-R, CSE11-R-DG, CSE12-L, CSE12-R, CSE12-R-DG, CSE21-L, CSE21-R, CSE21-R-DG, CSE22-L, CSE22-R, CSE22-R-DG, CSE61-L, CSE61-R, CSE61-R-DG, CSE62-L, CSE62-R, CSE62-R-DG, CSG11-L, CSG11-R, CSG11-R-DG, CSG12-L... (Other models you can see in the webshop)		

<b>Part No.</b>	378658	<b>Ref. No.</b>	10013519
<b>description</b>	temperature probe thermocouple K (NiCr-Ni) cable PTFE probe -50 up to 1150°C cable -40 up to +250°C connection coded plug probe 1.6x45 cable length 1.6m		

<b>Part No.</b>	378122	<b>Ref. No.</b>	203693
<b>description</b>	temperature probe thermocouple K (NiCr-Ni) cable silicone probe -50 up to 1150°C cable -50 up to +180°C connection 2-wire thread M10x1 probe ø3.5x13mm cable length 1.5m		
<b>For models:</b>	CCE60, CCE63, CGE11-L, CGE11-R, CGE12-L, CGE12-R, CGE61-L, CGE61-R, CGE62-L, CGE62-R, CGG11-L, CGG11-R, CGG12-L, CGG12-R, CGG61-L, CGG61-R, CGG62-L, CGG62-R, CPE60, CPE63, CSE11-L, CSE11-R, CSE11-R-DG, CSE12-L, CSE12-R, CSE12-R-DG, CSE61-L, CSE61-R, CSE61-R-DG, CSE62-L, CSE62-R, CSE62-R-DG, CSG11-L, CSG11-R, CSG11-R-DG, CSG12-L, CSG12-R, CSG12-R-DG, CSG61-L, CSG61-R, CSG61-R-DG, CSG62-L, CSG62-R, CSG62-R-DG		

<b>Part No.</b>	378123	<b>Ref. No.</b>	203990
<b>description</b>	temperature probe thermocouple K (NiCr-Ni) cable silicone probe -50 up to 1150°C cable -50 up to +180°C connection 2-wire thread M10x1 probe ø3.5x13mm cable length 2.3m		
<b>For models:</b>	CGE11-L, CGE11-R, CGE21-L, CGE21-R, CGE22-L, CGE22-R, CGE61-L, CGE61-R, CGG21-L, CGG21-R, CGG22-L, CGG22-R, CSE11-L, CSE11-R, CSE21-L, CSE21-R, CSE21-R-DG, CSE22-L, CSE22-R, CSE22-R-DG, CSE61-L, CSE61-R, CSG21-L, CSG21-R, CSG21-R-DG, CSG22-L, CSG22-R, CSG22-R-DG		


<b>core probes</b>			
<b>Part No.</b>	378537	<b>Ref. No.</b>	202738
<b>description</b>	core temperature probe multipoint probe cable PTFE probe -40 up to +250°C cable -40 up to +250°C connection 5-wire probe ø4x100mm thread 1/4" cable length 1.8m handle ø 11mm handle length 75mm		
<b>For models:</b>	CCE60, CCE63, CPE60, CPE63		

<b>Part No.</b>	378657	<b>Ref. No.</b>	10013578
<b>description</b>	core temperature probe multipoint probe cable PTFE probe -40 up to +250°C cable -40 up to +250°C connection plug probe ø4x100mm thread 1/4" cable length 0.8m handle ø 11mm handle length 75mm for combi-steamer		

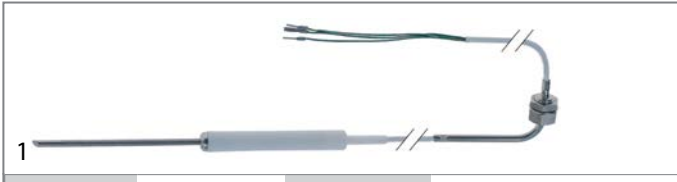
<b>Part No.</b>	378650	<b>Ref. No.</b>	10013579
<b>description</b>	core temperature probe multipoint probe cable PTFE probe -40 up to +250°C cable -40 up to +250°C connection plug probe ø4x100mm thread 1/4" cable length 1.2m handle ø 11mm handle length 75mm for combi-steamer		

<b>Part No.</b>	378651	<b>Ref. No.</b>	10015666
<b>description</b>	core temperature probe multipoint probe cable PTFE probe -40 up to +250°C cable -40 up to +250°C connection plug probe ø4x100mm thread 1/4" cable length 1.2m handle ø 11mm handle length 75mm for combi-steamer SS-reinforced/strip-wound hose		

<b>Part No.</b>	378541	<b>Ref. No.</b>	10013518
<b>description</b>	core temperature probe multipoint probe cable PTFE probe -40 up to +250°C cable -40 up to +250°C connection plug probe ø4x100mm thread cable length 1.1m handle ø 11mm handle length 75mm		

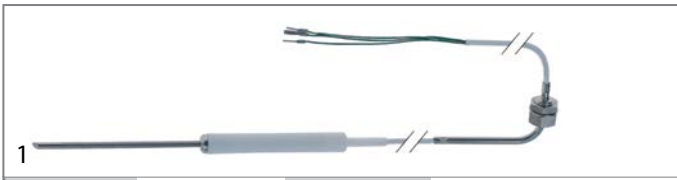



<b>Part No.</b>	378538	<b>Ref. No.</b>	10013516
<b>description</b>	core temperature probe Pt100 cable PTFE probe -40 up to +250°C cable -40 up to +250°C connection plug probe ø4x100mm thread 1/4" cable length 1.8m handle ø 11mm handle length 75mm		



<b>Part No.</b>	378124 <sup>1</sup>	<b>Ref. No.</b>	203697
<b>description</b>	core temperature probe thermocouple K (NiCr-Ni) cable PTFE probe -40 up to +250°C cable -40 up to +250°C connection 5-wire probe ø4x100mm thread 1/4" cable length 1.5m handle ø 12mm handle length 90mm		
<b>For models:</b>	CCE60, CCE63, CGE11-L, CGE11-R, CGE12-L, CGE12-R, CGE61-L, CGE61-R, CGE62-L, CGE62-R, CGG11-L, CGG11-R, CGG12-L, CGG12-R, CGG61-L, CGG61-R, CGG62-L, CGG62-R, CPE60, CPE63, CSE11-L, CSE11-R, CSE11-R-DG, CSE12-L, CSE12-R, CSE12-R-DG, CSE61-L, CSE61-R, CSE61-R-DG, CSE62-L, CSE62-R, CSE62-R-DG, CSG11-L, CSG11-R, CSG11-R-DG, CSG12-L, CSG12-R, CSG12-R-DG, CSG61-L, CSG61-R, CSG61-R-DG, CSG62-L, CSG62-R, CSG62-R-DG		

<sup>1</sup> multipoint probe




<b>Part No.</b>	378125 <sup>1</sup>	<b>Ref. No.</b>	203688
<b>description</b>	core temperature probe thermocouple K (NiCr-Ni) cable PTFE probe -40 up to +250°C cable -40 up to +250°C connection 5-wire probe ø4x100mm thread 1/4" cable length 1.9m handle ø 12mm handle length 90mm		
<b>For models:</b>	CCE60, CCE63, CGE21-L, CGE21-R, CGE22-L, CGE22-R, CGG21-L, CGG21-R, CGG22-L, CGG22-R, CPE60, CPE63, CSE21-L, CSE21-R, CSE21-R-DG, CSE22-L, CSE22-R, CSE22-R-DG, CSG21-L, CSG21-R, CSG21-R-DG, CSG22-L, CSG22-R, CSG22-R-DG		

<sup>1</sup> multipoint probe

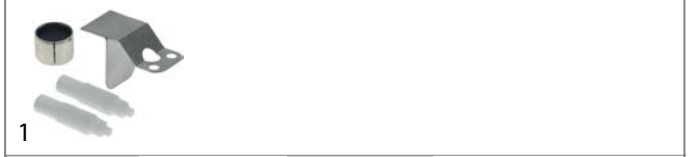
## accessories

### fasteners




<b>Part No.</b>	551022	<b>Ref. No.</b>	208032
<b>description</b>	probe clip		
<b>For models:</b>	CGE11-L, CGE11-R, CGE12-L, CGE12-R, CGE21-L, CGE21-R, CGE22-L, CGE22-R, CGE61-L, CGE61-R, CGE62-L, CGE62-R, CGG11-L, CGG11-R, CGG12-L, CGG12-R, CGG21-L, CGG21-R, CGG22-L, CGG22-R, CGG61-L, CGG61-R, CGG62-L, CGG62-R, CPE63, CSE11-L, CSE11-R, CSE12-L, CSE12-R, CSE21-L, CSE21-R, CSE21-R-DG, CSE22-L, CSE22-R, CSE22-R-DG, CSE61-L, CSE61-R, CSE62-L, CSE62-R, CSG11-L, CSG11-R, CSG11-R-DG, CSG12-L, CSG12-R, CSG12-R-DG, CSG21-L, CSG21-R, CSG21-R-DG, CSG22-L, CSG22-R...(Other models you can see in the webshop)		

### screw connections



<b>Part No.</b>	381514	<b>Ref. No.</b>	205183
<b>description</b>	screw connection kit for temperature probe		
<b>For models:</b>	CGE11-L, CGE11-R, CGE12-L, CGE12-R, CGE21-L, CGE21-R, CGE22-L, CGE22-R, CGE61-L, CGE61-R, CGE62-L, CGE62-R, CGG11-L, CGG11-R, CGG12-L, CGG12-R, CGG21-L, CGG21-R, CGG22-L, CGG22-R, CGG61-L, CGG61-R, CGG62-L, CGG62-R, CPE63, CSE11-L, CSE11-R, CSE12-L, CSE12-R, CSE21-L, CSE21-R, CSE21-R-DG, CSE22-L, CSE22-R, CSE22-R-DG, CSE61-L, CSE61-R, CSE62-L, CSE62-R, CSG11-L, CSG11-R, CSG11-R-DG, CSG12-L, CSG12-R, CSG12-R-DG, CSG21-L, CSG21-R, CSG21-R-DG, CSG22-L, CSG22-R...(Other models you can see in the webshop)		


### miscellaneous




<b>Part No.</b>	381515	<b>Ref. No.</b>	205327
<b>description</b>	protector for temperature probe ø 24.5mm H 28mm SS M12		
<b>For models:</b>	CCE60, CCE63, CGE11-L, CGE11-R, CGE12-L, CGE12-R, CGE21-L, CGE21-R, CGE22-L, CGE22-R, CGE61-L, CGE61-R, CGE62-L, CGE62-R, CGG11-L, CGG11-R, CGG12-L, CGG12-R, CGG21-L, CGG21-R, CGG22-L, CGG22-R, CGG61-L, CGG61-R, CGG62-L, CGG62-R, CPE60, CPE63, CSE11-L, CSE11-R, CSE11-R-DG, CSE12-L, CSE12-R, CSE12-R-DG, CSE61-L, CSE61-R, CSE61-R-DG, CSE62-L, CSE62-R, CSE62-R-DG, CSG11-L, CSG11-R, CSG11-R-DG, CSG12-L, CSG12-R, CSG12-R-DG, CSG21-L, CSG21-R, CSG21-R-DG, CSG22-L...(Other models you can see in the webshop)		

## electronics

### electronics accessories



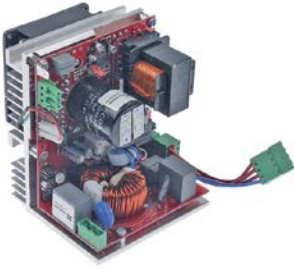
<b>Part No.</b>	694973	<b>Ref. No.</b>	207097
<b>description</b>	button for display PCB ø 15mm grey		
<b>For models:</b>	CGE11-L, CGE11-R, CGE12-L, CGE12-R, CGE21-L, CGE21-R, CGE22-L, CGE22-R, CGE61-L, CGE61-R, CGE62-L, CGE62-R, CGG11-L, CGG11-R, CGG12-L, CGG12-R, CGG21-L, CGG21-R, CGG22-L, CGG22-R, CGG61-L, CGG61-R, CGG62-L, CGG62-R, CPE63, CSE11-L, CSE11-R, CSE12-L, CSE12-R, CSE21-L, CSE21-R, CSE22-L, CSE22-R, CSE61-L, CSE61-R, CSE62-L, CSE62-R, CSG11-L, CSG11-R, CSG12-L, CSG12-R, CSG21-L, CSG21-R, CSG22-L, CSG22-R, CSG61-L, CSG61-R, CSG62-L, CSG62-R		

1

<b>Part No.</b>	348214	<b>Ref. No.</b>	207186
<b>description</b>	button for display PCB transparent suitable for MKN ED ø 16mm H 4.8mm for combi-steamer		
<b>For models:</b>	CSE11-L, CSE11-R, CSE11-R-DG, CSE12-L, CSE12-R, CSE12-R-DG, CSE21-L, CSE21-R, CSE21-R-DG, CSE22-L, CSE22-R, CSE22-R-DG, CSE61-L, CSE61-R, CSE61-R-DG, CSE62-L, CSE62-R, CSE62-R-DG, CSG11-L, CSG11-R, CSG11-R-DG, CSG12-L, CSG12-R, CSG12-R-DG, CSG21-L, CSG21-R, CSG21-R-DG, CSG22-L, CSG22-R, CSG22-R-DG, CSG61-L, CSG61-R, CSG61-R-DG, CSG62-L, CSG62-R, CSG62-R-DG		


frequency converters



1

<b>Part No.</b>	403214	<b>Ref. No.</b>	10012693 203784
<b>description</b>	frequency converter with fan tray for hot air motors 100-240V L 135mm W 110mm H 135mm output frequency 0-100Hz input frequency 47-63Hz		
<b>For models:</b>	CGE11-L, CGE11-R, CGE12-L, CGE12-R, CGE21-L, CGE21-R, CGE22-L, CGE22-R, CGE61-L, CGE61-R, CGE62-L, CGE62-R, CGG11-L, CGG11-R, CGG12-L, CGG12-R, CGG21-L, CGG21-R, CGG22-L, CGG22-R, CGG61-L, CGG61-R, CGG62-L, CGG62-R, CPE60, CSE11-L, CSE11-R, CSE12-L, CSE12-R, CSE21-L, CSE21-R, CSE22-L, CSE22-R, CSE61-L, CSE61-R, CSE62-L, CSE62-R, CSG11-L, CSG11-R, CSG11-R-DG, CSG12-L, CSG12-R, CSG12-R-DG, CSG21-L, CSG21-R, CSG21-R-DG, CSG22-L, CSG22-R, CSG22-R-DG, CSG61-L...(Other models you can see in the webshop)		


rectifiers



1

<b>Part No.</b>	400851	<b>Ref. No.</b>	203442
<b>description</b>	rectifier 420V 10A		
<b>For models:</b>	2013004B01, 2013004B02, 2013004B03, 2013004B04, 2013004B05, 2013008B01, 2013008B02, 2013008B03, 2013008B04, 2013008B05, 2013010B01, 2013010B02, 2013010B03, 2013010B04, 2013010B05, 2013018B00, 2013018B01, 2013018B02, 2013018B03, 2013018B04, 2021442-02, 2021442-03, 2021442A00, 2021442A01, 2021442A02, 2021442A03, 2021442B02, 2021442B03, 2021442C00, 2021442C01, 2021442C02, 2021442C03, 2021443-02, 2021443-03, 2021443-04, 2021443-05, 2021443A02, 2021443A03, 2021443A04, 2021443A05, 2021443B02, 2021443B03, 2021443B04, 2021443B05, 2021443C00, 2021443C01, 2021443C02, 2021443C03, 2021443C04, 2021443C05... (Other models you can see in the webshop)		

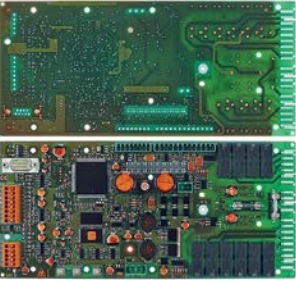
PCBs




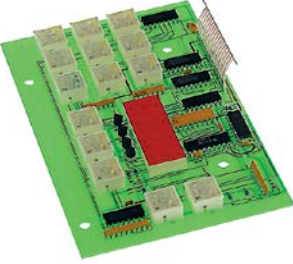

1


<b>Part No.</b>	401447	<b>Ref. No.</b>	203128
<b>description</b>	control PCB		
<b>For models:</b>	1220302-00, 1220302-01, 1220302B00, 1220302B01, 1220302D00, 1220302E00, 1220304-00, 1220304-01, 1220304A00, 1220304A01, 1220304A02, 1220304B00, 1220304B01, 1220304C00, 1220304C01, 1220304C02, 1220304D00, 1220304E00, 1220304F00, 1220304F01, 1220304H00, 1220304H01, 1220306-00, 1220306-01, 1220306A00, 1220306A01, 1220306A02, 1220306A03, 1220306A04, 1220306B00, 1220306B01, 1220306C00, 1220306C01, 1220306C02, 1220306C03, 1220306C04, 1220306D00, 1220306E00, 1220306F00, 1220306F01, 1220306F02, 1220306F03, 1220306H00, 1220306H01, 1220306H02, 1220306H03, 1320302-00, 1320302-01, 1320302B00, 1320302B01... (Other models you can see in the webshop)		





			
1			
<b>Part No.</b>	403807	<b>Ref. No.</b>	202676
<b>description</b>	control PCB combi-steamer Hans Dampf L 250mm W 115mm		
<b>For models:</b>	CCE60, CCE63, CSE11-L, CSE11-R, CSE11-R-DG, CSE12-L, CSE12-R, CSE12-R-DG, CSE21-L, CSE21-R, CSE21-R-DG, CSE22-L, CSE22-R, CSE22-R-DG, CSE61-L, CSE61-R, CSE61-R-DG, CSE62-L, CSE62-R, CSE62-R-DG, CSG11-L, CSG11-R, CSG11-R-DG, CSG12-L, CSG12-R, CSG12-R-DG, CSG21-L, CSG21-R, CSG21-R-DG, CSG22-L, CSG22-R, CSG22-R-DG, CSG61-L, CSG61-R, CSG61-R-DG, CSG62-L, CSG62-R, CSG62-R-DG		

			
2			
<b>Part No.</b>	403808	<b>Ref. No.</b>	202788
<b>description</b>	controller for USB MKN L 64.5mm W 31.5mm		
<b>For models:</b>	CGE11-L, CGE11-R, CGE12-L, CGE12-R, CGE21-L, CGE21-R, CGE22-L, CGE22-R, CGE61-L, CGE61-R, CGE62-L, CGE62-R, CGG11-L, CGG11-R, CGG12-L, CGG12-R, CGG21-L, CGG21-R, CGG22-L, CGG22-R, CGG61-L, CGG61-R, CGG62-L, CGG62-R		

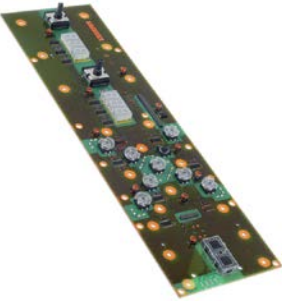
			
1			
<b>Part No.</b>	401445	<b>Ref. No.</b>	203124
<b>description</b>	keypad PCB		
<b>For models:</b>	1220302-00, 1220302-01, 1220302B00, 1220302B01, 1220302D00, 1220302E00, 1220304-00, 1220304-01, 1220304A00, 1220304A01, 1220304A02, 1220304B00, 1220304B01, 1220304C00, 1220304C01, 1220304C02, 1220304D00, 1220304E00, 1220304F00, 1220304F01, 1220304H00, 1220304H01, 1220306-00, 1220306-01, 1220306A00, 1220306A01, 1220306A02, 1220306A03, 1220306A04, 1220306B00, 1220306B01, 1220306C00, 1220306C01, 1220306C02, 1220306C03, 1220306C04, 1220306D00, 1220306E00, 1220306F00, 1220306F01, 1220306F02, 1220306F03, 1220306H00, 1220306H01, 1220306H02, 1220306H03, 1320302-00, 1320302-01, 1320302B00, 1320302B01... (Other models you can see in the webshop)		
<b>accessories for</b>	401445		
	<b>Part No.</b>	401446	<b>Ref. No.</b> 055055
	keypad foil L 170mm W 70mm buttons 14		


			
1			
<b>Part No.</b>	403034	<b>Ref. No.</b>	203746
<b>description</b>	keypad PCB		
<b>For models:</b>	CGE11-L, CGE11-R, CGE22-L, CGE22-R, CGE61-L, CGE61-R, CSE11-L, CSE11-R, CSE21-L, CSE21-R, CSE22-L, CSE22-R, CSE61-L, CSE61-R, CSG21-L, CSG21-R, CSG22-L, CSG22-R		


			
1			
<b>Part No.</b>	401697	<b>Ref. No.</b>	202690
<b>description</b>	keypad PCB combi-steamer Hans Dampf		
<b>For models:</b>	CSE11-L, CSE11-R, CSE11-R-DG, CSE12-L, CSE12-R, CSE12-R-DG, CSE21-L, CSE21-R, CSE21-R-DG, CSE22-L, CSE22-R, CSE22-R-DG, CSE61-L, CSE61-R, CSE61-R-DG, CSE62-L, CSE62-R, CSE62-R-DG, CSG11-L, CSG11-R, CSG11-R-DG, CSG12-L, CSG12-R, CSG12-R-DG, CSG21-L, CSG21-R, CSG21-R-DG, CSG22-L, CSG22-R, CSG22-R-DG, CSG61-L, CSG61-R, CSG61-R-DG, CSG62-L, CSG62-R, CSG62-R-DG		

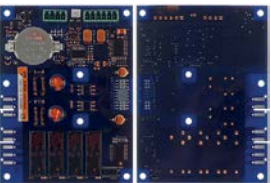
			
1			
<b>Part No.</b>	401698	<b>Ref. No.</b>	203745
<b>description</b>	keypad PCB combi-steamer Hans Dampf		
<b>For models:</b>	CGE11-L, CGE11-R, CGE12-L, CGE12-R, CGE21-L, CGE21-R, CGE22-L, CGE22-R, CGE61-L, CGE61-R, CGE62-L, CGE62-R, CGG11-L, CGG11-R, CGG12-L, CGG12-R, CGG21-L, CGG21-R, CGG22-L, CGG22-R, CGG61-L, CGG61-R, CGG62-L, CGG62-R, CSE11-L, CSE11-R, CSE12-L, CSE12-R, CSE22-L, CSE22-R, CSE61-L, CSE61-R, CSE62-L, CSE62-R, CSG11-L, CSG11-R, CSG12-L, CSG12-R, CSG61-L, CSG61-R, CSG62-L, CSG62-R		





			
1			
<b>Part No.</b>	403307	<b>Ref. No.</b>	202128
<b>description</b>	keypad PCB combi-steamer JUNIOR L 410mm W 115mm buttons 10		
<b>For models:</b>	CCE60, CCE63, CPE60, CPE63		

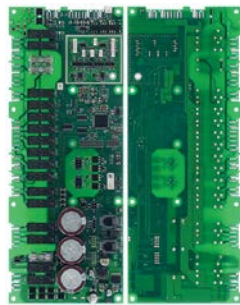
			
1			
<b>Part No.</b>	401969	<b>Ref. No.</b>	203766
<b>description</b>	PCB		
<b>For models:</b>	CGE11-L, CGE11-R, CGE12-L, CGE12-R, CGE21-L, CGE21-R, CGE22-L, CGE22-R, CGE61-L, CGE61-R, CGE62-L, CGE62-R, CGG11-L, CGG11-R, CGG12-L, CGG12-R, CGG21-L, CGG21-R, CGG22-L, CGG22-R, CGG61-L, CGG61-R, CGG62-L, CGG62-R, CSE11-L, CSE11-R, CSE61-L, CSE61-R		


			
1			
<b>Part No.</b>	401393	<b>Ref. No.</b>	203306
<b>description</b>	PCB 230V		
<b>For models:</b>	1023401-00, 1223202A00, 1223202A01, 1223202J00, 1223202J01, 1223209-00, 1223209-01, 1223401-00, 1223401J00, 1223402-00, 1323202A00, 1323202A01, 1323202A02, 1323209-00, 1323209-01, 1323209-02, 1323209-03, 1323210-00, 1323210-01, 1323210-02, 1323210-03, 1323210-04, 1323401-00, 1323402-00, 1323403-00, 1423401-00, 1423402-00, 1424818A00, 1424824-00, 1424824-01, 1424825-00, 1523401-00, 1523402-00, 2023212-00, 2023401-00, 2123207A00, 2123207A01, 2123208A00, 2123208A01, 2123208A02, 2123208A03, 2123210-00, 2123401-00, 2123402-00, 2123403-00, 3023401-00		

			
1			
<b>Part No.</b>	403806	<b>Ref. No.</b>	202698
<b>description</b>	PCB combi-steamer Hans Dampf L 115mm W 87mm		
<b>For models:</b>	CSG11-L, CSG11-R, CSG11-R-DG, CSG12-L, CSG12-R, CSG12-R-DG, CSG21-L, CSG21-R, CSG21-R-DG, CSG22-L, CSG22-R, CSG22-R-DG, CSG61-L, CSG61-R, CSG61-R-DG, CSG62-L, CSG62-R, CSG62-R-DG		

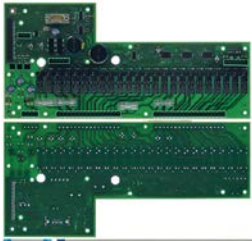
			
1			
<b>Part No.</b>	403809	<b>Ref. No.</b>	202600
<b>description</b>	PCB for combi-steamer Hans Dampf L 28mm W 27mm for ignition electrode		
<b>For models:</b>	CGG11-L, CGG11-R, CGG12-L, CGG12-R, CGG21-L, CGG21-R, CGG22-L, CGG22-R, CGG61-L, CGG61-R, CGG62-L, CGG62-R, CSG11-L, CSG11-R, CSG12-L, CSG12-R, CSG21-L, CSG21-R, CSG22-L, CSG22-R, CSG61-L, CSG61-R, CSG62-L, CSG62-R		

			
1			
<b>Part No.</b>	403869	<b>Ref. No.</b>	203773
<b>description</b>	PCB for combi-steamer L 50mm W 50mm		
<b>For models:</b>	CPE63		

			
1			
<b>Part No.</b>	403876	<b>Ref. No.</b>	10013404
<b>description</b>	PCB L 320mm W 125mm		

			
1			
<b>Part No.</b>	400074	<b>Ref. No.</b>	203911
<b>description</b>	PCB pyroceram range 2023206-00 400V		
<b>For models:</b>	0723405-01, 0723405-02, 0723409-01, 0723409-02, 0723413-02, 0723414-02, 1023410-00, 1423404-00, 1423404-01, 1423405-00, 1423405-01, 1423405-02, 1423409-00, 1423409-01, 1423409-02, 1423413-02, 1423414-02, 1424819-00, 1424826-00, 1523405-00, 1523405-01, 1523409-00, 1523409-01, 1523410-00, 2023206-00, 2023206-01, 2023206-02, 2023207-00, 2023207-01, 2023207-02, 2023207-03, 2023207-04, 2023207-05, 2023405-00, 2023405D00, 2023406-00, 2023407-00, 2023407-01, 2023409-00, 3023206-00, 3023206-01, 3023206-02, 3023405-00, 3023406-00, 3023409-00		





1			
<b>Part No.</b>	403872	<b>Ref. No.</b>	203747
<b>description</b>	relay PCB for combi-steamer L 320mm W 150mm		
<b>For models:</b>	CCE60, CCE63, CGE11-L, CGE11-R, CGE12-L, CGE12-R, CGE21-L, CGE21-R, CGE22-L, CGE22-R, CGE61-L, CGE61-R, CGE62-L, CGE62-R, CGG11-L, CGG11-R, CGG12-L, CGG12-R, CGG21-L, CGG21-R, CGG22-L, CGG22-R, CGG61-L, CGG61-R, CGG62-L, CGG62-R, CPE60, CPE63, CSE11-L, CSE11-R, CSE12-L, CSE12-R, CSE21-L, CSE21-R, CSE22-L, CSE22-R, CSE61-L, CSE61-R, CSE62-L, CSE62-R, CSG21-L, CSG21-R, CSG22-L, CSG22-R, CSG61-L, CSG61-R, CSG62-L, CSG62-R		



1			
<b>Part No.</b>	403877	<b>Ref. No.</b>	10013402
<b>description</b>	touch panel mounting frame inclusive L 400mm W 208mm		

## keypads

### front foils



1			
<b>Part No.</b>	401446	<b>Ref. No.</b>	055055
<b>description</b>	keypad foil L 170mm W 70mm buttons 14		
<b>For models:</b>	1220302-00, 1220302-01, 1220302B00, 1220302B01, 1220302D00, 1220302E00, 1220304-00, 1220304-01, 1220304A00, 1220304A01, 1220304A02, 1220304B00, 1220304B01, 1220304C00, 1220304C01, 1220304C02, 1220304D00, 1220304E00, 1220304F00, 1220304F01, 1220304H00, 1220304H01, 1220306-00, 1220306-01, 1220306A00, 1220306A01, 1220306A02, 1220306A03, 1220306A04, 1220306B00, 1220306B01, 1220306C00, 1220306C01, 1220306C02, 1220306C03, 1220306C04, 1220306D00, 1220306E00, 1220306F00, 1220306F01, 1220306F02, 1220306F03, 1220306H00, 1220306H01, 1220306H02, 1220306H03, 1320302-00, 1320302-01, 1320302B00, 1320302B01... (Other models you can see in the webshop)		

## solenoid valves

### solenoid valves (water)

#### INTERELEKTRIK

medium temperature: 90°C 90°C 60°C  
 ambient temperature: 60°C 25°C 60°C  
 duty cycle: 40% 100% 100%

#### with reducers



1			
<b>Part No.</b>	370747	<b>Ref. No.</b>	201142
<b>description</b>	solenoid valve double straight 220-240VAC inlet 3/4" outlet 10.5mm INTERELEKTRIK plastic output B 3l/min flow regulating valve outlet B red		
<b>For models:</b>	CGE11-L, CGE11-R, CGE12-L, CGE12-R, CGE61-L, CGE61-R, CGE62-L, CGE62-R, CPE63, CSE11-L, CSE11-R, CSE12-L, CSE12-R, CSE61-L, CSE61-R, CSE62-L, CSE62-R		





1			
<b>Part No.</b>	370843	<b>Ref. No.</b>	203663
<b>description</b>	solenoid valve single straight 220-240 inlet 3/4" outlet 1/2" input 2l/min DN8 t.max. 90°C duty cycle 100% INTERELEKTRIK plastic flow regulating valve inlet yellow total length 84.5mm		
<b>For models:</b>	1422807B03, 1422807B04, 1422831-00, 1422832-00, 1422833-00, 1422834-00, 1422902-03, 1422902-04, 1422908-00, 1422910-00, 1423901-00, 1423901-01, 1423901-02, 1423902-00, 1423902-01, 1423902-02, 1423903-00, 1423903-01, 1423903-02, 1424101-00, 1424101-01, 1424102-00, 1424102-01, 1424103-00, 1424104-00, 1462831-00, 1462832-00, 1462833-00, 1462834-00, 1462835-00, 1462836-00, 1462837-00, 1462838-00, 1462839-00, 1462840-00, 1462908-00, 1462910-00, 2013901-00, 2013901-01, 2013901-02, 2013901-03, 2013902-00, 2013902-01, 2013902-02, 2013902-03, 2013903-00, 2013903-01, 2013903-02, 2013903-03, 2022802B08... (Other models you can see in the webshop)		



1			
<b>Part No.</b>	370746	<b>Ref. No.</b>	201140
<b>description</b>	solenoid valve single straight 220-240VAC inlet 3/4" outlet 10.5mm output 3l/min INTERELEKTRIK plastic flow regulating valve outlet red		
<b>For models:</b>	CGE11-L, CGE11-R, CGE12-L, CGE12-R, CGE61-L, CGE61-R, CGE62-L, CGE62-R, CSE11-L, CSE11-R, CSE12-L, CSE12-R, CSE61-L, CSE61-R, CSE62-L, CSE62-R		



			
1			
<b>Part No.</b>	370144	<b>Ref. No.</b>	201160
<b>description</b>	solenoid valve single straight 230VAC outlet 10.5mm t.max. 90°C plastic inlet 3/4"mm		
<b>For models:</b>	CGE11-L, CGE11-R, CGE12-L, CGE12-R, CGE21-L, CGE21-R, CGE22-L, CGE22-R, CGE61-L, CGE61-R, CGE62-L, CGE62-R, CGG11-L, CGG11-R, CGG12-L, CGG12-R, CGG21-L, CGG21-R, CGG22-L, CGG22-R, CGG61-L, CGG61-R, CGG62-L, CGG62-R, CSE11-L, CSE11-R, CSE11-R-DG, CSE12-L, CSE12-R, CSE12-R-DG, CSE21-L, CSE21-R, CSE21-R-DG, CSE22-L, CSE22-R, CSE22-R-DG, CSE61-L, CSE61-R, CSE61-R-DG, CSE62-L, CSE62-R, CSE62-R-DG, CSG11-L, CSG11-R, CSG11-R-DG, CSG12-L, CSG12-R, CSG21-L, CSG21-R, CSG21-R-DG...(Other models you can see in the webshop)		


			
1			
<b>Part No.</b>	370308	<b>Ref. No.</b>	203832
<b>description</b>	valve unit 24VDC		
<b>For models:</b>	CGE11-L, CGE11-R, CGE12-L, CGE12-R, CGE21-L, CGE21-R, CGE22-L, CGE22-R, CGE61-L, CGE61-R, CGE62-L, CGE62-R, CGG11-L, CGG11-R, CGG12-L, CGG12-R, CGG21-L, CGG21-R, CGG22-L, CGG22-R, CGG61-L, CGG61-R, CGG62-L, CGG62-R, CSE11-L, CSE11-R, CSE11-R-DG, CSE12-L, CSE12-R, CSE12-R-DG, CSE21-L, CSE21-R, CSE21-R-DG, CSE22-L, CSE22-R, CSE22-R-DG, CSE61-L, CSE61-R, CSE61-R-DG, CSE62-L, CSE62-R, CSE62-R-DG, CSG11-L, CSG11-R, CSG11-R-DG, CSG12-L, CSG12-R, CSG12-R-DG, CSG21-L, CSG21-R, CSG21-R-DG...(Other models you can see in the webshop)		

**MÜLLER**


medium temperature: 90°C  
duty cycle: 100%

spare parts and accessories

miscellaneous

			
1			
<b>Part No.</b>	371002	<b>Ref. No.</b>	10011599
<b>description</b>	solenoid valve holder MÜLLER flange support		
<b>For models:</b>	CSE11-L, CSE11-R, CSE11-R-DG, CSE12-L, CSE12-R, CSE12-R-DG, CSE21-L, CSE21-R, CSE21-R-DG, CSE22-L, CSE22-R, CSE22-R-DG, CSE61-L, CSE61-R, CSE61-R-DG, CSE62-L, CSE62-R, CSE62-R-DG, CSG11-L, CSG11-R, CSG11-R-DG, CSG12-L, CSG12-R, CSG12-R-DG, CSG21-L, CSG21-R, CSG21-R-DG, CSG22-L, CSG22-R, CSG22-R-DG, CSG61-L, CSG61-R, CSG61-R-DG, CSG62-L, CSG62-R, CSG62-R-DG		


various

			
1			
<b>Part No.</b>	370307	<b>Ref. No.</b>	203831
<b>description</b>	valve unit 24VDC		
<b>For models:</b>	CGE21-L, CGE21-R, CGE22-L, CGE22-R, CGG21-L, CGG21-R, CGG22-L, CGG22-R, CSE11-L, CSE11-R, CSE11-R-DG, CSE12-L, CSE12-R, CSE12-R-DG, CSE21-L, CSE21-R, CSE21-R-DG, CSE22-L, CSE22-R, CSE22-R-DG, CSE61-L, CSE61-R, CSE61-R-DG, CSE62-L, CSE62-R, CSE62-R-DG, CSG11-L, CSG11-R, CSG11-R-DG, CSG12-L, CSG12-R, CSG12-R-DG, CSG21-L, CSG21-R, CSG21-R-DG, CSG22-L, CSG22-R, CSG22-R-DG, CSG61-L, CSG61-R, CSG61-R-DG, CSG62-L, CSG62-R, CSG62-R-DG		


metal


PARKER

solenoid valves (various)

			
1			
<b>Part No.</b>	370749	<b>Ref. No.</b>	201153
<b>description</b>	solenoid valve 2-ways 230VAC inlet 1/8" outlet 1/8" connection 1/8" L 30mm PARKER type series WB4.5 membranes Viton p max 10bar 50/60Hz brass		
<b>For models:</b>	CPE63		

solenoid valves (various)

			
1			
<b>Part No.</b>	370175	<b>Ref. No.</b>	201657
<b>description</b>	solenoid valve 2-ways 230VAC connection 1/4" brass		
<b>For models:</b>	1422802B04, 1422802B05, 1422802B06, 1422804B04, 1422804B05, 1422804B06, 1422805B04, 1422805B05, 1422805B06, 1422807B00, 1422807B01, 1422807B02, 1422902-00, 1422902-01, 1422902-02, 1462802B00, 1462802B01, 1462802B02, 1462802B03, 1462802B04, 1462802B05, 1462804B00, 1462804B01, 1462804B02, 1462804B03, 1462804B04, 1462804B05, 2022801-02, 2022801-03, 2022801A02, 2022801A03, 2022801B02, 2022801B03, 2022801C02, 2022801C03, 2022802-02, 2022802-03, 2022802A02, 2022802A03, 2022802B02, 2022802B03, 2022802B04, 2022802B05, 2022802B06, 2022802B07, 2022802C02, 2022802C03, 2022802C07, 2022803-02, 2022803-03...(Other models you can see in the webshop)		





1

<b>Part No.</b>	370748	<b>Ref. No.</b>	201141
<b>description</b>	solenoid valve 2-ways 230VAC inlet 1/8" outlet 1/8" L 40mm p max 10bar 50Hz brass		
<b>For models:</b>	CGE11-L, CGE11-R, CGE12-L, CGE12-R, CGE21-L, CGE21-R, CGE22-L, CGE22-R, CGE61-L, CGE61-R, CGE62-L, CGE62-R, CGG11-L, CGG11-R, CGG12-L, CGG12-R, CGG21-L, CGG21-R, CGG22-L, CGG22-R, CGG61-L, CGG61-R, CGG62-L, CGG62-R, CPE63, CSE11-L, CSE11-R, CSE12-L, CSE12-R, CSE21-L, CSE21-R, CSE22-L, CSE22-R, CSE61-L, CSE61-R, CSE62-L, CSE62-R, CSG11-L, CSG11-R, CSG12-L, CSG12-R, CSG21-L, CSG21-R, CSG22-L, CSG22-R, CSG61-L, CSG61-R		

**solenoid valves (gas)**

**DUNGS**




1

<b>Part No.</b>	102379 <sup>1</sup>	<b>Ref. No.</b>	201529
<b>description</b>	solenoid valve 230VAC connection 1/2" L 76mm DUNGS p max 0.2bar p min 0bar reg. no. 63AQ0626 gas inlet 1/2" gas outlet 1/2"		
<b>For models:</b>	2061403-00, 2061403-01, 20614033-0, 2061403A00, 2061403B00, 2061403C00, 2061404-00, 2061404-01, 20614044-0, 2061404A00, 2061404B00, 2061404C00, 2061405-00, 2061405B00, 2061406-00, 2061406B00, 20628033-0, 20628044-0, 20629011-0, 20629022-0, 3061403-00, 3061403A00, 3061403B00, 3061403C00, 3061404-00, 3061404A00, 3061404B00, 3061404C00, 3061405-00, 3061405B00, 3061405B01, 3061406-00, 3061406B00		


<sup>1</sup>aluminium housing

**Solenoid valve - accessories**



1


<b>Part No.</b>	371001	<b>Ref. No.</b>	204532
<b>description</b>	solenoid valve holder		
<b>For models:</b>	1422807B03, 1422807B04, 1422831-00, 1422832-00, 1422833-00, 1422834-00, 1422902-03, 1422902-04, 1422908-00, 1422910-00, 1462831-00, 1462832-00, 1462833-00, 1462834-00, 1462835-00, 1462836-00, 1462837-00, 1462838-00, 1462839-00, 1462840-00, 1462908-00, 1462910-00, 2022802B08, 2022802B09, 2022802B10, 2022802C08, 2022802C09, 2022802C10, 2022802D00, 2022802D01, 2022802D02, 2022804B08, 2022804B09, 2022804B10, 2022804C08, 2022804C09, 2022804C10, 2022804D00, 2022804D01, 2022804D02, 2022805B08, 2022805B09, 2022805B10, 2022805C08, 2022805C09, 2022805C10, 2022805D00, 2022805D01, 2022807B06, 2022807B07... (Other models you can see in the webshop)		



1


<b>Part No.</b>	371002	<b>Ref. No.</b>	10011599
<b>description</b>	solenoid valve holder MÜLLER flange support		
<b>For models:</b>	CSE11-L, CSE11-R, CSE11-R-DG, CSE12-L, CSE12-R, CSE12-R-DG, CSE21-L, CSE21-R, CSE21-R-DG, CSE22-L, CSE22-R, CSE22-R-DG, CSE61-L, CSE61-R, CSE61-R-DG, CSE62-L, CSE62-R, CSE62-R-DG, CSG11-L, CSG11-R, CSG11-R-DG, CSG12-L, CSG12-R, CSG12-R-DG, CSG21-L, CSG21-R, CSG21-R-DG, CSG22-L, CSG22-R, CSG22-R-DG, CSG61-L, CSG61-R, CSG61-R-DG, CSG62-L, CSG62-R, CSG62-R-DG		

**pressure switches for steam control**



1

<b>Part No.</b>	541139	<b>Ref. No.</b>	203399
<b>description</b>	pressure control ø 45mm pressure connection vertical steam control pressure range 0.8/0.65bar connection 1/4" pressure connection 1/4"		
<b>For models:</b>	1422802B04, 1422802B05, 1422802B06, 1422802B07, 1422802B08, 1422804B04, 1422804B05, 1422804B06, 1422804B07, 1422804B08, 1422805B04, 1422805B05, 1422805B06, 1422805B07, 1422805B08, 1422807B00, 1422807B01, 1422807B02, 1422807B03, 1422807B04, 1422831-00, 1422832-00, 1422833-00, 1422834-00, 1422902-00, 1422902-01, 1422902-02, 1422902-03, 1422902-04, 1422908-00, 1422910-00, 1462802B00, 1462802B01, 1462802B02, 1462802B03, 1462802B04, 1462802B05, 1462804B00, 1462804B01, 1462804B02, 1462804B03, 1462804B04, 1462804B05, 1462831-00, 1462832-00, 1462835-00, 1462836-00, 1462837-00, 1462908-00, 2022802B04... (Other models you can see in the webshop)		





1

<b>Part No.</b>	541022	<b>Ref. No.</b>	203439
<b>description</b>	pressure control steam control pressure connection vertical pressure range adjustable 0.25-4.5bar connection 1/4" pressure connection 1/4" IT		
<b>For models:</b>	14228011-0, 14228022-0, 14228033-0, 14228044-0, 14228055-0, 2022801-00, 2022801-01, 2022801-02, 2022801-03, 20228011-0, 20228011-1, 2022801A00, 2022801A01, 2022801A02, 2022801A03, 2022801B00, 2022801B01, 2022801B02, 2022801B03, 2022801C00, 2022801C01, 2022801C02, 2022801C03, 2022802-00, 2022802-01, 2022802-02, 2022802-03, 20228022-0, 20228022-1, 2022802A00, 2022802A01, 2022802A02, 2022802A03, 2022802B00, 2022802B01, 2022802B02, 2022802B03, 2022802C00, 2022802C01, 2022802C02, 2022802C03, 2022803-00, 2022803-01, 2022803-02, 2022803-03, 20228033-0, 20228033-1, 2022803A00, 2022803A01, 2022803A02... (Other models you can see in the webshop)		






for combi-steamers


			
1			
<b>Part No.</b>	543037	<b>Ref. No.</b>	202601
<b>description</b>	pressure control ø 23mm pressure range 15/25mbar connection 9mm 42V 2A		
<b>For models:</b>	CCE60, CCE63, CPE60, CPE63		

			
1			
<b>Part No.</b>	542407	<b>Ref. No.</b>	10011816 10017027
<b>description</b>	pressure control triggering pressure 100bar 48V 0.5A 1/4"		

electrodes

			
1			
<b>Part No.</b>	400122	<b>Ref. No.</b>	230867
<b>description</b>	level electrode 1/4" probe L 102mm insulated probe length 95mm		

			
1			
<b>Part No.</b>	401409	<b>Ref. No.</b>	203858 203859 203867 845591
<b>description</b>	level electrode 1/4" total length 132mm probe L 102mm insulated probe length 95mm connection F6.3 ø 3mm		
<b>spare parts for</b>	401409		
	<b>Part No.</b>	401458	<b>Ref. No.</b> 203601
	 level electrode M10x1 total length 132mm probe L 112mm insulated probe length 105mm connection F6.3 1/8"		

			
1			
<b>Part No.</b>	401458	<b>Ref. No.</b>	203601
<b>description</b>	level electrode M10x1 total length 132mm probe L 112mm insulated probe length 105mm connection F6.3 1/8"		
<b>For models:</b>	1422802B04, 1422802B05, 1422802B06, 1422802B07, 1422802B08, 1422804B04, 1422804B05, 1422804B06, 1422804B07, 1422804B08, 1422805B04, 1422805B05, 1422805B06, 1422805B07, 1422805B08, 1422807B00, 1422807B01, 1422807B02, 1422807B03, 1422807B04, 1422831-00, 1422832-00, 1422833-00, 1422834-00, 1422902-00, 1422902-01, 1422902-02, 1422902-03, 1422902-04, 1422908-00, 1422910-00, 1423901-00, 1423901-01, 1423901-02, 1423902-00, 1423902-01, 1423902-02, 1423903-00, 1423903-01, 1423903-02, 1462802B01, 1462802B02, 1462802B03, 1462802B04, 1462802B05, 1462804B01, 1462804B02, 1462804B03, 1462804B04, 1462804B05... (Other models you can see in the webshop)		

flow meters and flow sensors

flow meters

GICAR

			
1			
<b>Part No.</b>	403873	<b>Ref. No.</b>	203687
<b>description</b>	flow meter thread M10x1 plastic nominal-ø 2mm approval NSF Qmax. 2.3l/min		
<b>For models:</b>	CGE11-L, CGE11-R, CGE12-L, CGE12-R, CGE21-L, CGE21-R, CGE22-L, CGE22-R, CGE61-L, CGE61-R, CGE62-L, CGE62-R, CGG11-L, CGG11-R, CGG12-L, CGG12-R, CGG21-L, CGG21-R, CGG22-L, CGG22-R, CGG61-L, CGG61-R, CGG62-L, CGG62-R, CSE11-L, CSE11-R, CSE12-L, CSE12-R, CSE21-L, CSE21-R, CSE22-L, CSE22-R, CSE61-L, CSE61-R, CSE62-L, CSE62-R, CSG11-L, CSG11-R, CSG12-L, CSG12-R, CSG21-L, CSG21-R, CSG22-L, CSG22-R, CSG61-L, CSG61-R		





## fans

## axial fans

## ebm-papst



1

<b>Part No.</b>	601030 <sup>1</sup>	<b>Ref. No.</b>	203155
<b>description</b>	axial fan L 119mm W 119mm H 38mm 230VAC 50Hz 18W bearing ball bearing manuf. no. 4656Z metal connection male faston 2.8mm ebm-papst fan wheel ø 110mm temp.-resist. 75°C		
<b>For models:</b>	0723104B03, 0723105B03, 1223204-00, 1223204-01, 1223204-02, 1223205-00, 1223205-01, 1223205-02, 1223206-00, 1223206-01, 1223206-02, 1223212-00, 1223214-00, 1423104B03, 1423105B03, 2023114-00, 2023118-00, 2023119-00, 2023206-00, 2023206-01, 2023207-00, 2023207-01, 2023207-02, 2023207-03, 2023207-04, 2023503-04, 2023503-05, 2023503-06, 2023503-07, 2023503-08, 2023503-09, 2023503-10, 2023503A04, 2023503A05, 2023503A06, 2023503A07, 2023503A08, 2023503A09, 2023503A10, 2123207A00, 2123208A00, 2123208A01, 2123208A02, 2123503-01, 2123503-02, 2123503-03, 2123503-04, 2123503-05, 2123503-06, 2123503A01... (Other models you can see in the webshop)		
<b>accessories for</b>	601030		
	<b>Part No.</b>	550898	<b>Ref. No.</b> —
	connecting cable cable length 2000mm connection F 2.8 connection distance 7.9mm for axial flow fan		
	<b>Part No.</b>	692497	<b>Ref. No.</b> —
	guard ø 105mm mounting distance 150mm for axial fan ebm-papst-mm		

<sup>1</sup>with ball bearings

1


<b>Part No.</b>	601715 <sup>1</sup>	<b>Ref. No.</b>	203819
<b>description</b>	axial fan L 119mm W 119mm H 38mm 230VAC 50Hz 18W bearing ball bearing manuf. no. 4656ZW metal connection cable 310mm ebm-papst fan wheel ø 110mm temp.-resist. 75°C		
<b>For models:</b>	CCE60, CCE63, CGG21-L, CGG21-R, CGG22-L, CGG22-R, CPE60, CPE63, CSE11-L, CSE11-R, CSE11-R-DG, CSE12-L, CSE12-R, CSE12-R-DG, CSE61-L, CSE61-R, CSE61-R-DG, CSE62-L, CSE62-R, CSE62-R-DG, CSG11-L, CSG11-R, CSG11-R-DG, CSG12-L, CSG12-R, CSG12-R-DG, CSG21-L, CSG21-R, CSG21-R-DG, CSG22-L, CSG22-R, CSG22-R-DG, CSG61-L, CSG61-R, CSG61-R-DG, CSG62-L, CSG62-R, CSG62-R-DG		

<sup>1</sup>with ball bearings

## import



1

<b>Part No.</b>	601130 <sup>1</sup>	<b>Ref. No.</b>	203152
<b>description</b>	axial fan L 80mm W 80mm H 25mm 230VAC 50/60Hz 13/14W bearing ball bearing connection male faston 2.8mm metal ADDA fan wheel ø 75mm temp.-resist. 70°C airflow 30.6m <sup>3</sup> /h		
<b>accessories for</b>	601130		
	<b>Part No.</b>	550898	<b>Ref. No.</b> —
	connecting cable cable length 2000mm connection F 2.8 connection distance 7.9mm for axial flow fan		

<sup>1</sup>with ball bearings

## hot air motors



1

<b>Part No.</b>	601862	<b>Ref. No.</b>	203977
<b>description</b>	fan motor 200-230V 3 phase 50Hz 0.45/0.65kW 700/1400rpm speeds 2 L1 145mm L2 35mm L3 35mm 0.7/2A D1 ø 17mm D2 ø 13.5mm		
<b>For models:</b>	CGE11-L, CGE11-R, CGE12-L, CGE12-R, CGE61-L, CGE61-R, CGE62-L, CGE62-R, CSE11-L, CSE11-R, CSE12-L, CSE12-R, CSE61-L, CSE61-R, CSE62-L, CSE62-R		



1

<b>Part No.</b>	501583	<b>Ref. No.</b>	202745
<b>description</b>	fan motor 200-240V 50/60Hz 3000/3600rpm L1 125mm L2 35mm L3 15mm ø 100mm 0.5/0,7A type L5tw2 - 695 D1 ø 8mm D2 ø 8x7.5mm		
<b>For models:</b>	CCE60, CCE63, CPE60, CPE63		






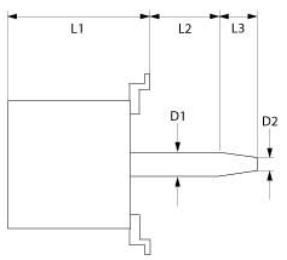
1

<b>Part No.</b>	602153	<b>Ref. No.</b>	202673
<b>description</b>	fan motor 200-480V 3 phase 50/60Hz 0.6-0.82kW 1380/1650rpm speeds 1 L1 151mm L2 67mm L3 35mm ø 160mm M10 IT 2.8/1.6A at 50Hz 200-415V at 60Hz 200-480V at 50Hz 1380rpm at 60Hz 1650rpm type L9Fw4D-678 no. C6 D1 ø 17mm D2 ø 13.5mm with shaft sealing		
<b>For models:</b>	CSE11-L, CSE11-R, CSE11-R-DG, CSE12-L, CSE12-R, CSE12-R-DG, CSE21-L, CSE21-R, CSE21-R-DG, CSE22-L, CSE22-R, CSE22-R-DG, CSE61-L, CSE61-R, CSE61-R-DG, CSE62-L, CSE62-R, CSE62-R-DG		



1

<b>Part No.</b>	514512	<b>Ref. No.</b>	062002
<b>description</b>	fan wheel blades 12 D1 ø 350mm D2 ø 13mm D3 ø 16mm H1 115mm H2 32mm H3 4.5mm		
<b>For models:</b>	CGE11-L, CGE11-R, CGE12-L, CGE12-R, CGE21-L, CGE21-R, CGE22-L, CGE22-R, CGE61-L, CGE61-R, CGE62-L, CGE62-R, CGG11-L, CGG11-R, CGG12-L, CGG12-R, CGG21-L, CGG21-R, CGG22-L, CGG22-R, CSE11-L, CSE11-R, CSE11-R-DG, CSE12-L, CSE12-R, CSE12-R-DG, CSE21-L, CSE21-R, CSE21-R-DG, CSE22-L, CSE22-R, CSE22-R-DG, CSE61-L, CSE61-R, CSE61-R-DG, CSE62-L, CSE62-R, CSE62-R-DG, CSG11-L, CSG11-R, CSG11-R-DG, CSG12-L, CSG12-R, CSG12-R-DG, CSG21-L, CSG21-R, CSG21-R-DG, CSG22-L, CSG22-R, CSG22-R-DG		

1

<b>Part No.</b>	601485	<b>Ref. No.</b>	203771
<b>description</b>	fan motor 240V 3 phase 60Hz 0.68kW 1730rpm speeds 1 L1 150mm L2 24mm L3 35mm M10R IT 2.9A power input 870W at 60Hz 1730rpm type L9DFw4D-596 no. W6 D1 ø 17mm D2 ø 13mm		
<b>For models:</b>	CGE11-L, CGE11-R, CGE12-L, CGE12-R, CGE21-L, CGE21-R, CGE22-L, CGE22-R, CGE61-L, CGE61-R, CGE62-L, CGE62-R, CGG11-L, CGG11-R, CGG12-L, CGG12-R, CGG21-L, CGG21-R, CGG22-L, CGG22-R, CGG61-L, CGG61-R, CGG62-L, CGG62-R, CSE11-L, CSE11-R, CSE12-L, CSE12-R, CSE21-L, CSE21-R, CSE22-L, CSE22-R, CSE61-L, CSE61-R, CSE62-L, CSE62-R, CSG11-L, CSG11-R, CSG11-R-DG, CSG12-L, CSG12-R, CSG12-R-DG, CSG21-L, CSG21-R, CSG21-R-DG, CSG22-L, CSG22-R, CSG22-R-DG, CSG61-L, CSG61-R...(Other models you can see in the webshop)		




1

<b>Part No.</b>	514513	<b>Ref. No.</b>	062008
<b>description</b>	fan wheel blades 45 D1 ø 197mm D2 ø 13mm D3 ø 15mm H1 43mm H2 23mm H3 3mm		
<b>For models:</b>	CCE60, CPE60		




1

<b>Part No.</b>	514511	<b>Ref. No.</b>	062005
<b>description</b>	fan wheel blades 12 D1 ø 280mm D2 ø 13mm D3 ø 16mm H1 110mm H2 31mm H3 4.5mm		
<b>For models:</b>	CGG61-L, CGG61-R, CGG62-L, CGG62-R, CSG61-L, CSG61-R, CSG61-R-DG, CSG62-L, CSG62-R, CSG62-R-DG		



1

<b>Part No.</b>	699359	<b>Ref. No.</b>	945446
<b>description</b>	flange ED ø 60mm int. ø 1 22mm SS M4		
<b>For models:</b>	CGE11-L, CGE11-R, CGE12-L, CGE12-R, CGE21-L, CGE21-R, CGE22-L, CGE22-R, CGE61-L, CGE61-R, CGE62-L, CGE62-R, CGG11-L, CGG11-R, CGG12-L, CGG12-R, CGG21-L, CGG21-R, CGG22-L, CGG22-R, CGG61-L, CGG61-R, CGG62-L, CGG62-R, CPE63, CSE11-L, CSE11-R, CSE11-R-DG, CSE12-L, CSE12-R, CSE12-R-DG, CSE21-L, CSE21-R, CSE21-R-DG, CSE22-L, CSE22-R, CSE22-R-DG, CSE61-L, CSE61-R, CSE61-R-DG, CSE62-L, CSE62-R, CSE62-R-DG, CSG11-L, CSG11-R, CSG11-R-DG, CSG12-L, CSG12-R, CSG12-R-DG, CSG21-L...(Other models you can see in the webshop)		



1

<b>Part No.</b>	699364	<b>Ref. No.</b>	204681
<b>description</b>	flange for combi-steamer ED ø 50mm int. ø 1 24mm int. ø 2 19mm thickness 7mm SS		
<b>For models:</b>	CCE60, CGE11-L, CGE11-R, CGE12-L, CGE12-R, CGE21-L, CGE21-R, CGE22-L, CGE22-R, CGE61-L, CGE61-R, CGE62-L, CGE62-R, CGG11-L, CGG11-R, CGG12-L, CGG12-R, CGG21-L, CGG21-R, CGG22-L, CGG22-R, CGG61-L, CGG61-R, CGG62-L, CGG62-R, CPE60, CSE11-L, CSE11-R, CSE11-R-DG, CSE12-L, CSE12-R, CSE12-R-DG, CSE21-L, CSE21-R, CSE21-R-DG, CSE22-L, CSE22-R, CSE22-R-DG, CSE61-L, CSE61-R, CSE61-R-DG, CSE62-L, CSE62-R, CSE62-R-DG, CSG11-L, CSG11-R, CSG11-R-DG, CSG12-L, CSG12-R, CSG12-R-DG, CSG21-L, CSG21-R...(Other models you can see in the webshop)		



1

<b>Part No.</b>	699363	<b>Ref. No.</b>	204423
<b>description</b>	flange for combi-steamer ED $\phi$ 57mm int. $\phi$ 1 24mm int. $\phi$ 2 19mm thickness 7mm SS		
<b>For models:</b>	CGE11-L, CGE11-R, CGE12-L, CGE12-R, CGE21-L, CGE21-R, CGE22-L, CGE22-R, CGE61-L, CGE61-R, CGE62-L, CGE62-R, CGG11-L, CGG11-R, CGG12-L, CGG12-R, CGG21-L, CGG21-R, CGG22-L, CGG22-R, CGG61-L, CGG61-R, CGG62-L, CGG62-R, CSE11-L, CSE11-R, CSE11-R-DG, CSE12-L, CSE12-R, CSE12-R-DG, CSE21-L, CSE21-R, CSE21-R-DG, CSE22-L, CSE22-R, CSE22-R-DG, CSE61-L, CSE61-R, CSE61-R-DG, CSE62-L, CSE62-R, CSE62-R-DG, CSG11-L, CSG11-R, CSG11-R-DG, CSG12-L, CSG12-R, CSG12-R-DG, CSG21-L, CSG21-R...(Other models you can see in the webshop)		



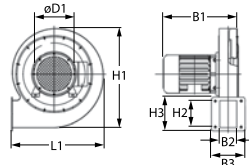
1

<b>Part No.</b>	699360	<b>Ref. No.</b>	945661
<b>description</b>	flange for combi-steamer int. $\phi$ 1 22mm int. $\phi$ 2 8.5mm thickness 4mm SS L 53mm W 50mm M4		
<b>For models:</b>	CCE60, CCE63, CGE11-L, CGE11-R, CGE12-L, CGE12-R, CGE21-L, CGE21-R, CGE22-L, CGE22-R, CGE61-L, CGE61-R, CGE62-L, CGE62-R, CGG11-L, CGG11-R, CGG12-L, CGG12-R, CGG21-L, CGG21-R, CGG22-L, CGG22-R, CGG61-L, CGG61-R, CGG62-L, CGG62-R, CPE60, CPE63, CSE11-L, CSE11-R, CSE11-R-DG, CSE12-L, CSE12-R, CSE12-R-DG, CSE21-L, CSE21-R, CSE21-R-DG, CSE22-L, CSE22-R, CSE22-R-DG, CSE61-L, CSE61-R, CSE61-R-DG, CSE62-L, CSE62-R, CSE62-R-DG, CSG11-L, CSG11-R, CSG11-R-DG, CSG12-L...(Other models you can see in the webshop)		

## radial fans



1



<b>Part No.</b>	601181	<b>Ref. No.</b>	203994
<b>description</b>	radial fan 230V voltage AC 50Hz 100W H1 170mm L1 175mm D1 $\phi$ 50mm W1 115mm W2 40mm H2 45mm		
<b>For models:</b>	1462831-00, 1462832-00, 1462833-00, 1462834-00, 1462835-00, 1462836-00, 1462837-00, 1462838-00, 1462839-00, 1462840-00, 1462908-00, 1462910-00, 2062831-00, 2062832-00, 2062833-00, 2062834-00, 2062835-00, 2062835-01, 2062836-00, 2062836-01, 2062837-00, 2062837-01, 2062838-00, 2062838-01, 2062839-00, 2062839-01, 2062840-00, 2062840-01, 2062908-00, 2062910-00, 2162835-00, 2162835-01, 2162838-00, 2162838-01, 3062831-00, 3062832-00, 3062833-00, 3062834-00, 3062835-00, 3062836-00, 3062837-00, 3062838-00, 3062839-00, 3062840-00, 3062908-00, 3062910-00, CGG11-L, CGG11-R, CGG12-L, CGG12-R...(Other models you can see in the webshop)		

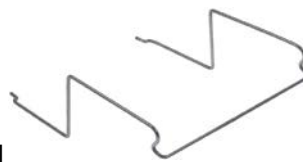
## miscellaneous



1

<b>Part No.</b>	601475	<b>Ref. No.</b>	203926
<b>description</b>	radial fan 230V voltage AC 50/60Hz 20W H1 180mm L1 180mm D1 $\phi$ 86mm W1 40mm W2 34mm H2 122mm W3 40mm H3 172mm		
<b>For models:</b>	1424833-01, 1424834-01, 1424835-01, 1424836-01, 2023210-01, 2023211-01, CGE11-L, CGE11-R, CGE12-L, CGE12-R, CGE21-L, CGE21-R, CGE22-L, CGE22-R, CGE61-L, CGE61-R, CGE62-L, CGE62-R, CGG11-L, CGG11-R, CGG12-L, CGG12-R, CGG21-L, CGG21-R, CGG22-L, CGG22-R, CGG61-L, CGG61-R, CGG62-L, CGG62-R, CSE11-L, CSE11-R, CSE11-R-DG, CSE12-L, CSE12-R, CSE12-R-DG, CSE21-L, CSE21-R, CSE21-R-DG, CSE22-L, CSE22-R, CSE22-R-DG, CSE61-L, CSE61-R, CSE61-R-DG, CSE62-L, CSE62-R, CSE62-R-DG, CSG11-L, CSG11-R...(Other models you can see in the webshop)		

## accessories universal



1

<b>Part No.</b>	521183	<b>Ref. No.</b>	204607
<b>description</b>	support bracket L 125mm W 105mm fan for HDECOD61		
<b>For models:</b>	CSE11-L, CSE11-R, CSE11-R-DG, CSE12-L, CSE12-R, CSE12-R-DG, CSE61-L, CSE61-R, CSE61-R-DG, CSE62-L, CSE62-R, CSE62-R-DG, CSG11-L, CSG11-R, CSG11-R-DG, CSG12-L, CSG12-R, CSG12-R-DG, CSG61-L, CSG61-R, CSG61-R-DG, CSG62-L, CSG62-R, CSG62-R-DG		



## motors

### gear motors

#### for grills



1

<b>Part No.</b>	500801	<b>Ref. No.</b>	203039
<b>description</b>	gear motor 230V		
<b>For models:</b>	1220303A00, 1220303A01, 1220303A02, 1220303A03, 1220303C00, 1220303C01, 1220303C02, 1220303C03, 1220303F01, 1220303F02, 1220303F03, 1220303H00, 1220303H01, 1220303H02, 1220303H03, 1220304A00, 1220304A01, 1220304A02, 1220304C00, 1220304C01, 1220304C02, 1220304F00, 1220304F01, 1220304H00, 1220304H01, 1220305A00, 1220305A01, 1220305A02, 1220305A03, 1220305A04, 1220305A05, 1220305C00, 1220305C01, 1220305C02, 1220305C03, 1220305C04, 1220305C05, 1220305F01, 1220305F02, 1220305F03, 1220305F04, 1220305F05, 1220305H00, 1220305H01, 1220305H02, 1220305H03, 1220305H04, 1220305H05, 1220306A00, 1220306A01... (Other models you can see in the webshop)		

### spindle motors

#### miscellaneous

1

<b>Part No.</b>	500665	<b>Ref. No.</b>	203157
<b>description</b>	spindle motor		
<b>For models:</b>	2020303-00, 2020303-01, 2020303-02		

1

<b>Part No.</b>	500666	<b>Ref. No.</b>	203388
<b>description</b>	spindle motor		
<b>For models:</b>	2020303-03, 2020303-04		

1

<b>Part No.</b>	500667	<b>Ref. No.</b>	203144
<b>description</b>	spindle motor		
<b>For models:</b>	2021402-02, 2021402-03, 2021402-04, 2021402-05, 2021402-06, 2021402-07, 2021402-08, 2021402A01, 2021402A02, 2021402A03, 2021402A04, 2021402A06, 2021402A07, 2021402A08, 2021402B01, 2021402B02, 2021402B03, 2021402B04, 2021402B06, 2021402B07, 2021402B08, 2021402C01, 2021402C02, 2021402C03, 2021402C04, 2021402C06, 2021402C07, 2021402C08, 2021404-00, 2021404-01, 2021404-02, 2021404-03, 2021404-04, 2021404-05, 2021404-06, 20214044-0, 2021404A00, 2021404A01, 2021404A02, 2021404A04, 2021404A05, 2021404A06, 2021404B00, 2021404B01, 2021404B02, 2021404B04, 2021404B05, 2021404B06, 2021404C00, 2021404C01... (Other models you can see in the webshop)		

1

<b>Part No.</b>	500668	<b>Ref. No.</b>	203147
<b>description</b>	spindle motor		
<b>For models:</b>	2021402-00, 2021402-01, 2021402A00, 2021402B00, 2021402C00, 2061402-00, 2061402-01, 2061402A00, 2061402B00, 2061402C00		

## pumps

### drain pumps

#### HANNING





1

<b>Part No.</b>	499302	<b>Ref. No.</b>	203788
<b>description</b>	drain pump inlet ø 24mm outlet ø 24mm 220-240V 30W 50Hz HANNING type DPS25-303		
<b>For models:</b>	CPE63		





magnetic-drive pumps

			
1			
<b>Part No.</b>	500696	<b>Ref. No.</b>	203825
<b>description</b>	magnetic-drive pump HANNING type DP040-025 30W 230V 50Hz inlet ø 24mm outlet ø 11mm L 130mm		
<b>For models:</b>	CCE60, CCE63, CGE11-L, CGE11-R, CGE12-L, CGE12-R, CGE21-L, CGE21-R, CGE22-L, CGE22-R, CGE61-L, CGE61-R, CGE62-L, CGE62-R, CGG11-L, CGG11-R, CGG12-L, CGG12-R, CGG21-L, CGG21-R, CGG22-L, CGG22-R, CGG61-L, CGG61-R, CGG62-L, CGG62-R, CPE60, CPE63, CSE11-L, CSE11-R, CSE11-R-DG, CSE12-L, CSE12-R, CSE12-R-DG, CSE21-L, CSE21-R, CSE21-R-DG, CSE22-L, CSE22-R, CSE22-R-DG, CSE61-L, CSE61-R, CSE61-R-DG, CSE62-L, CSE62-R, CSE62-R-DG, CSG11-L, CSG11-R, CSG11-R-DG, CSG12-L...(Other models you can see in the webshop)		


			
1			
<b>Part No.</b>	499303	<b>Ref. No.</b>	203826
<b>description</b>	magnetic-drive pump HANNING type DP040-028 65W 208-240V 60Hz inlet ø 24mm outlet ø 11mm L 140mm		
<b>For models:</b>	CCE60, CCE63, CGE11-L, CGE11-R, CGE12-L, CGE12-R, CGE21-L, CGE21-R, CGE22-L, CGE22-R, CGE61-L, CGE61-R, CGE62-L, CGE62-R, CGG11-L, CGG11-R, CGG12-L, CGG12-R, CGG21-L, CGG21-R, CGG22-L, CGG22-R, CGG61-L, CGG61-R, CGG62-L, CGG62-R, CPE60, CPE63, CSE11-L, CSE11-R, CSE11-R-DG, CSE12-L, CSE12-R, CSE12-R-DG, CSE21-L, CSE21-R, CSE21-R-DG, CSE22-L, CSE22-R, CSE22-R-DG, CSE61-L, CSE61-R, CSE61-R-DG, CSE62-L, CSE62-R, CSE62-R-DG, CSG11-L, CSG11-R, CSG11-R-DG, CSG12-L...(Other models you can see in the webshop)		


filters

			
1			
<b>Part No.</b>	381485	<b>Ref. No.</b>	203743
<b>description</b>	RC circuit type LA4DA2U 110-240V Qty 1 pcs		
<b>For models:</b>	CGE21-L, CGE21-R, CGE22-L, CGE22-R, CSE21-L, CSE21-R, CSE21-R-DG, CSE22-L, CSE22-R, CSE22-R-DG		

			
1			
<b>Part No.</b>	380049	<b>Ref. No.</b>	203683
<b>description</b>	RC circuit type LAD4RCU 110-250V		
<b>For models:</b>	0720332R00, 0720332V00, 1220329B00, 1220329B01, 1320329B00, 1320329B01, 1320329C01, 1320329C02, 1420329B00, 1420329B01, 1420329C00, 1420329C01, 1422701-02, 1422701-03, 1422702-02, 1422702-03, 1422703-01, 1422703-02, 1422704-01, 1422704-02, 1422705-01, 1422705-02, 1422706-01, 1422706-02, 1422707-01, 1422707-02, 1422708-01, 1422708-02, 1423901-00, 1423901-01, 1423901-02, 1423902-00, 1423902-01, 1423902-02, 1423903-00, 1423903-01, 1423903-02, 1424101-01, 1424102-01, 1424103-00, 1424104-00, 2012828-00, 2012828-01, 2012828-02, 2012828-03, 2012828-04, 2012828-05, 2020329B01, 2020329B02, 2020329C01...(Other models you can see in the webshop)		


fuses

			
1			
<b>Part No.</b>	358598	<b>Ref. No.</b>	202776
<b>description</b>	fine fuse size ø5x20mm 0.63A slow-acting rated 250V Qty 10 pcs		
<b>For models:</b>	0720332R00, 0720332V00		


			
1			
<b>Part No.</b>	358599	<b>Ref. No.</b>	203720
<b>description</b>	fine fuse size ø5x20mm 0.8A slow-acting rated 250V Qty 10 pcs		
<b>For models:</b>	0521702B03, 0521702B04, 2022828-01, 2022828-02, 2022828-03, 2022828-04, 2022828-05, 2022828-06, 3022828-03, 3022828-04, 3022828-05, 3022828-06, 3022828-07, CGE11-L, CGE11-R, CGE12-L, CGE12-R, CGE21-L, CGE21-R, CGE22-L, CGE22-R, CGE61-L, CGE61-R, CGE62-L, CGE62-R, CPE63, CSE11-L, CSE11-R, CSE12-L, CSE12-R, CSE21-L, CSE21-R, CSE22-L, CSE22-R, CSE61-L, CSE61-R, CSE62-L, CSE62-R		


condensators & interference suppression filters


operating capacitors


			
1			
<b>Part No.</b>	365031	<b>Ref. No.</b>	202742
<b>description</b>	operating capacitor capacity 4µF 450V tolerance 5% 50/60Hz ambient temperature max. -25 to +85°C ø 31mm L 58mm M8 plastic connection male faston 6.3mm protection		
<b>For models:</b>	CCE60, CCE63, CPE60, CPE63		




			
1			
<b>Part No.</b>	358601	<b>Ref. No.</b>	203722
<b>description</b>	fine fuse size ø5x20mm 1.25A slow-acting rated 250V Qty 10 pcs		
<b>For models:</b>	CCE60, CCE63, CGE12-L, CGE12-R, CGE62-L, CGE62-R, CGG11-L, CGG11-R, CGG12-L, CGG12-R, CGG21-L, CGG21-R, CGG22-L, CGG22-R, CGG61-L, CGG61-R, CGG62-L, CGG62-R, CPE60, CPE63, CSE12-L, CSE12-R, CSE62-L, CSE62-R, CSG11-L, CSG11-R, CSG11-R-DG, CSG12-L, CSG12-R, CSG12-R-DG, CSG21-L, CSG21-R, CSG21-R-DG, CSG22-L, CSG22-R, CSG22-R-DG, CSG61-L, CSG61-R, CSG61-R-DG, CSG62-L, CSG62-R, CSG62-R-DG		


			
1			
<b>Part No.</b>	358607	<b>Ref. No.</b>	203473
<b>description</b>	fine fuse size ø5x20mm 6.3A slow-acting rated 250V Qty 10 pcs		
<b>For models:</b>	1422701-01, 1422701-02, 1422701-03, 1422702-01, 1422702-02, 1422702-03, 1422802B04, 1422802B05, 1422802B06, 1422802B07, 1422802B08, 1422804B04, 1422804B05, 1422804B06, 1422804B07, 1422804B08, 1422805B04, 1422805B05, 1422805B06, 1422805B07, 1422805B08, 1422807B00, 1422807B01, 1422807B02, 1422807B03, 1422807B04, 1422902-00, 1422902-01, 1422902-02, 1422902-03, 1422902-04, 2013004B01, 2013004B02, 2013004B03, 2013004B04, 2013004B05, 2013008B01, 2013008B02, 2013008B03, 2013008B04, 2013008B05, 2013010B01, 2013010B02, 2013010B03, 2013010B04, 2013010B05, 2013018B00, 2013018B01, 2013018B02, 2013018B03... (Other models you can see in the webshop)		

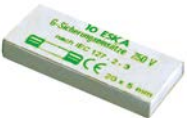
			
1			
<b>Part No.</b>	358608	<b>Ref. No.</b>	203996
<b>description</b>	fine fuse size ø5x20mm 10A slow-acting rated 250V Qty 10 pcs		
<b>For models:</b>	CGE11-L, CGE11-R, CGE12-L, CGE12-R, CGE21-L, CGE21-R, CGE22-L, CGE22-R, CGE61-L, CGE61-R, CGE62-L, CGE62-R, CGG11-L, CGG11-R, CGG12-L, CGG12-R, CGG21-L, CGG21-R, CGG22-L, CGG22-R, CGG61-L, CGG61-R, CGG62-L, CGG62-R, CPE63, CSE11-L, CSE11-R, CSE11-R-DG, CSE12-L, CSE12-R, CSE12-R-DG, CSE21-L, CSE21-R, CSE21-R-DG, CSE22-L, CSE22-R, CSE22-R-DG, CSE61-L, CSE61-R, CSE61-R-DG, CSE62-L, CSE62-R, CSE62-R-DG, CSG11-L, CSG11-R, CSG11-R-DG, CSG12-L, CSG12-R, CSG12-R-DG, CSG21-L... (Other models you can see in the webshop)		

			
1			
<b>Part No.</b>	358704	<b>Ref. No.</b>	203741
<b>description</b>	fine fuse size ø5x20mm 8A slow-acting rated 250V Qty 10 pcs		

			
1			
<b>Part No.</b>	358603	<b>Ref. No.</b>	203474
<b>description</b>	fine fuse size ø5x20mm 2A slow-acting rated 250V Qty 10 pcs		
<b>For models:</b>	0220302A00, 0220302A01, 0220302A02, 0220302A03, 0220302C00, 0220302C01, 0220302C02, 0220302C03, 0220303A00, 0220303A01, 0220303A02, 0220303A03, 0220303B00, 0220303B01, 0220303C00, 0220303C01, 0220303C02, 0220303E00, 0220303E01, 0220304-00, 0220305-00, 0220306-00, 0221501-00, 0221502-00, 0720332P00, 0720332R00, 0720332T00, 0720332V00, 1220307-00, 1220307-01, 1220308-00, 1220326-00, 1220326-01, 1220326B00, 1220326B01, 1220327-00, 1220327-01, 1220327B01, 1220329-00, 1220329-01, 1220329B00, 1220329B01, 1221112-00, 1320323-00, 1320323B00, 1320327-00, 1320327A00, 1320327A01, 1320327A02, 1320327B00... (Other models you can see in the webshop)		


fine fuse holders

			
1			
<b>Part No.</b>	551378	<b>Ref. No.</b>	203635
<b>description</b>	fuse holder for USIG suitable fuse 5x20/5x25/5x30 1-pole 6.3A rated 400V L 45.4mm W 9.9mm H 32mm connection plug-in connection Phönix Control ST-SI		
<b>For models:</b>	0220302A00, 0220302A01, 0220302A02, 0220302A03, 0220302C00, 0220302C01, 0220302C02, 0220302C03, 0220302H00, 0220302H01, 0220303A00, 0220303A01, 0220303A02, 0220303A03, 0220303C00, 0220303C01, 0220303C02, 0220303H00, 0220303H01, 0220304-00, 0220305-00, 0220306-00, 0221501-00, 0221502-00, 0521702B03, 0521702B04, 0720332P00, 0720332R00, 0720332T00, 0720332V00, 1220307-00, 1220307-01, 1220308-00, 1220326-00, 1220326-01, 1220326B00, 1220326B01, 1220327-00, 1220327-01, 1220327B01, 1220329-00, 1220329-01, 1220329B00, 1220329B01, 1221112-00, 1320323-00, 1320323B00, 1320327-00, 1320327A00, 1320327A01... (Other models you can see in the webshop)		

			
1			
<b>Part No.</b>	358605	<b>Ref. No.</b>	203742
<b>description</b>	fine fuse size ø5x20mm 3.15A slow-acting rated 250V Qty 10 pcs		

screw locks

D0-system (NEOZED)

			
1			
<b>Part No.</b>	358045	<b>Ref. No.</b>	203739
<b>description</b>	fuse size D02 35A rated 250/400V E18 ø 15mm L 36mm Qty 10 pcs		
<b>For models:</b>	CGE21-L, CGE21-R, CGG11-L, CGG11-R, CGG12-L, CGG12-R, CGG61-L, CGG61-R, CSE12-L, CSE12-R, CSE12-R-DG, CSE21-L, CSE21-R, CSE21-R-DG, CSG11-L, CSG11-R, CSG11-R-DG		





## electric accessories

## plugs - couplings - power sockets

## CEE plugs with cable



<b>Part No.</b>	551433	<b>Ref. No.</b>	203830
<b>description</b>	connecting cable CEE 5-pole contacts 3P+N+E max. 63A max 415V 16mm <sup>2</sup> 4.25m straight protection IP67 for combi-steamer		
<b>For models:</b>	CGE11-L, CGE11-R, CGE12-L, CGE12-R, CGE61-L, CGE61-R, CGE62-L, CGE62-R, CGG11-L, CGG11-R, CGG12-L, CGG12-R, CGG61-L, CGG61-R, CGG62-L, CGG62-R		

## cables

## accessories

## cable glands

## cable glands



<b>Part No.</b>	551448	<b>Ref. No.</b>	203452
<b>description</b>	cable gland mounting ø 20.6mm plastic Qty 1 pcs		
<b>For models:</b>	0522101-00, 0522101-01, 0522101-02, 0522101-03, 0522101-04, 0522102-00, 0522102-01, 0522102-02, 0522102-03, 0522102-04, 1303701-01, 1303702-01, 1303703-01, 1303704-00, 1303705-00, 1320301D02, 1320301E02, 1320303D03, 1320303E03, 1320303F03, 1320303F04, 1320303H03, 1320303H04, 1320304F03, 1320304F04, 1320304H03, 1320304H04, 1320305D04, 1320305D05, 1320305E04, 1320305E05, 1320305F04, 1320305F05, 1320305F06, 1320305H04, 1320305H05, 1320305H06, 1320306F04, 1320306F05, 1320306F06, 1320306H04, 1320306H05, 1320306H06, 1320321-00, 1320321-01, 1320321-02, 1320321B00, 1320321B01, 1320321B02, 1320323-00... (Other models you can see in the webshop)		

## ribbon cables

## group 2



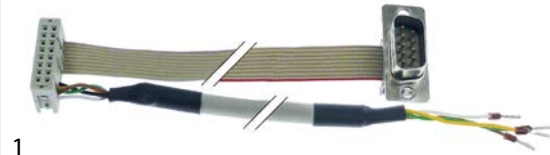
<b>Part No.</b>	551411	<b>Ref. No.</b>	203916
<b>description</b>	connection cable 8-pole L 1000mm plug type RJ45		
<b>For models:</b>	0723104-03, 0723104A03, 0723104B03, 0723105-03, 0723105A03, 0723105B03, 1023101-00, 1023101-01, 1023106-00, 1023106-01, 1223101-00, 1223101-01, 1223101-02, 1223103-00, 1223103-01, 1223103-02, 1223106-00, 1223106-01, 1223106-02, 1223111-00, 1223203-03, 1223211-01, 1323101-01, 1323101-02, 1323103-01, 1323103-02, 1323106-00, 1423101-00, 1423101-01, 1423101-02, 1423101A00, 1423101A01, 1423103-00, 1423103-01, 1423103-02, 1423103A00, 1423103A01, 1423104-00, 1423104-01, 1423104-02, 1423104-03, 1423104A00, 1423104A01, 1423104A03, 1423104B03, 1423105-00, 1423105-01, 1423105-02, 1423105-03, 1423105A00... (Other models you can see in the webshop)		

## group 11



<b>Part No.</b>	551353	<b>Ref. No.</b>	033047
<b>description</b>	ribbon cable 40-pole L 60mm		

## connection cables



<b>Part No.</b>	579003	<b>Ref. No.</b>	033057
<b>description</b>	connection cable L 1030mm 13-pole for USB		
<b>For models:</b>	CGE21-L, CGE21-R, CGE22-L, CGE22-R, CGE61-L, CGE61-R, CGE62-L, CGE62-R, CGG21-L, CGG21-R, CGG22-L, CGG22-R, CGG61-L, CGG61-R, CGG62-L, CGG62-R		

## terminals and connectors


## insulated


## inline splice connectors





<b>Part No.</b>	550158	<b>Ref. No.</b>	203080
<b>description</b>	butt splice connector 0.5-1.5mm <sup>2</sup> Cu gal Sn insulation PVC red t.max. 75°C Qty 100 pcs		
<b>For models:</b>	0220302H00, 0220302H01, 0220303H00, 0220303H01, 0520303-02, 0521704-04, 0521704-05, 0521704-06, 0521704-07, 1423502-00, 1423502-01, 1423502-02, 1423502A00, 1423502A01, 1423502A02, 1423505-00, 1423505-01, 1423505A00, 1423505A01, 1424815-04, 1424815A04, 1424817-00, 1424817A00, 2020314-01, 2020314-02, 2020314-03, 2020314A01, 2020314A02, 2020314A03, 2020315-01, 2020315-02, 2020315-03, 2020315A01, 2020315A02, 2020315A03, 2020341-00, 2020341A00, 2020342-00, 2020342A00, 2020406A01, 2023502-05, 2023502-06, 2023502A05, 2023502A06, 2023503-07, 2023503-11, 2023503-12, 2023503A07, 2023503A11, 2023503A12... (Other models you can see in the webshop)		




not insulated			
female fastons			
iron nickel-plated			
			
1			
<b>Part No.</b>	550001	<b>Ref. No.</b>	203089
<b>description</b>	female faston size 6.3x0.8mm 1.0-2.5mm <sup>2</sup> straight Fe gal Ni t.max. 340°C Qty 100 pcs		
<b>For models:</b>	0220302A00, 0220302A01, 0220302A02, 0220302A03, 0220302C00, 0220302C01, 0220302C02, 0220302C03, 0220303A00, 0220303A01, 0220303A02, 0220303A03, 0220303C00, 0220303C01, 0220303C02, 0220304-00, 0220305-00, 0220306-00, 1423901-00, 1423901-01, 1423901-02, 1423902-00, 1423902-01, 1423902-02, 1423903-00, 1423903-01, 1423903-02, 1462802B00, 1462802B01, 1462802B02, 1462802B03, 1462802B04, 1462802B05, 1462804B00, 1462804B01, 1462804B02, 1462804B03, 1462804B04, 1462804B05, 1462831-00, 1462832-00, 1462835-00, 1462836-00, 1462837-00, 1462908-00, 2013901-00, 2013901-01, 2013901-02, 2013901-03, 2013902-00... (Other models you can see in the webshop)		


plug connectors			
			
1			
<b>Part No.</b>	551450	<b>Ref. No.</b>	203732
<b>description</b>	plug connector 4-pole male faston 6.3mm L 52mm		
<b>For models:</b>	CGE11-L, CGE11-R, CGE12-L, CGE12-R, CGE21-L, CGE21-R, CGE22-L, CGE22-R, CGE61-L, CGE61-R, CGE62-L, CGE62-R, CGG11-L, CGG11-R, CGG12-L, CGG12-R, CGG21-L, CGG21-R, CGG22-L, CGG22-R, CGG61-L, CGG61-R, CGG62-L, CGG62-R, CSE11-L, CSE11-R, CSE12-L, CSE12-R, CSE21-L, CSE21-R, CSE21-R-DG, CSE22-L, CSE22-R, CSE22-R-DG, CSG11-L, CSG11-R, CSG11-R-DG, CSG12-L, CSG12-R, CSG12-R-DG, CSG21-L, CSG21-R, CSG21-R-DG, CSG22-L, CSG22-R, CSG22-R-DG, CSG61-L, CSG61-R, CSG61-R-DG, CSG62-L... (Other models you can see in the webshop)		

			
1			
<b>Part No.</b>	551452	<b>Ref. No.</b>	203731
<b>description</b>	plug connector 4-pole male faston 6.3mm L 54mm		
<b>For models:</b>	CCE60, CCE63, CGE11-L, CGE11-R, CGE12-L, CGE12-R, CGE21-L, CGE21-R, CGE22-L, CGE22-R, CGE61-L, CGE61-R, CGE62-L, CGE62-R, CGG11-L, CGG11-R, CGG12-L, CGG12-R, CGG21-L, CGG21-R, CGG22-L, CGG22-R, CGG61-L, CGG61-R, CGG62-L, CGG62-R, CPE60, CPE63, CSE11-L, CSE11-R, CSE11-R-DG, CSE12-L, CSE12-R, CSE12-R-DG, CSE21-L, CSE21-R, CSE21-R-DG, CSE22-L, CSE22-R, CSE22-R-DG, CSE61-L, CSE61-R, CSE61-R-DG, CSE62-L, CSE62-R, CSE62-R-DG, CSG11-L, CSG11-R, CSG11-R-DG, CSG12-L... (Other models you can see in the webshop)		

			
1			
<b>Part No.</b>	551354	<b>Ref. No.</b>	202689
<b>description</b>	plug connector 50-pole raster size 2mm		
<b>For models:</b>	CCE60, CCE63, CPE60, CPE63, CSE11-L, CSE11-R, CSE11-R-DG, CSE12-L, CSE12-R, CSE12-R-DG, CSE21-L, CSE21-R, CSE21-R-DG, CSE22-L, CSE22-R, CSE22-R-DG, CSE61-L, CSE61-R, CSE61-R-DG, CSE62-L, CSE62-R, CSE62-R-DG, CSG11-L, CSG11-R, CSG11-R-DG, CSG12-L, CSG12-R, CSG12-R-DG, CSG21-L, CSG21-R, CSG21-R-DG, CSG22-L, CSG22-R, CSG22-R-DG, CSG61-L, CSG61-R, CSG61-R-DG, CSG62-L, CSG62-R, CSG62-R-DG		

terminals			
connection terminals with screw/faston connections			
			
1			
<b>Part No.</b>	551372	<b>Ref. No.</b>	203287
<b>description</b>	connection terminal 3-pole max. 16A max 400V connection ø2.5mm <sup>2</sup> / F6.3 temp.-resist. 150°C		
<b>For models:</b>	0521704-00, 0521704-01, 0521704-02, 0521704-03, 0521704-04, 0521704-05, 0521704-06, 0521704-07, 0521704A00, 0521704A01, 0521705-00, 0521705-01, 0521706-00, 1220501-00, 1220501-01, 1220501-02, 1220502-00, 1220502-01, 1220601-00, 1220802-00, 1220802-01, 1320501-00, 1320502-00, 1320601-00, 1320802-00, 1520501-00, 1520601-00		

			
1			
<b>Part No.</b>	550110	<b>Ref. No.</b>	203264
<b>description</b>	power terminal block 5-pole max. 40A max 250V connection M6/ male faston 6.3mm temp.-resist. 130°C		
<b>For models:</b>	0021130A00, 0021130A01, 0021135A00, 0220301-00, 0220301B00, 0220301B01, 0220301B02, 0220301D00, 0220302-00, 0220302A00, 0220302A01, 0220302A02, 0220302A03, 0220302B00, 0220302B01, 0220302B02, 0220302C00, 0220302C01, 0220302C02, 0220302C03, 0220302D00, 0220302E00, 0220302E01, 0220302F00, 0220302H00, 0220302H01, 0220303-00, 0220303-01, 0220303A00, 0220303A01, 0220303A02, 0220303A03, 0220303D00, 0220303D01, 0220303H00, 0220303H01, 0220304-00, 0220305-00, 0220306-00, 0220501-00, 0220502-00, 0220503-00, 0220601-00, 0220802-00, 0221001H00, 0221101-00, 0221101-01, 0221101A00, 0221101A01, 0221102-00... (Other models you can see in the webshop)		

PCB terminal blocks			
			
1			
<b>Part No.</b>	551355	<b>Ref. No.</b>	203690
<b>description</b>	PCB terminal block 5-pole raster size 3.8mm cross section 1.5mm <sup>2</sup>		
<b>For models:</b>	CGE11-L, CGE11-R, CGE12-L, CGE12-R, CGE21-L, CGE21-R, CGE22-L, CGE22-R, CGE61-L, CGE61-R, CGE62-L, CGE62-R, CGG11-L, CGG11-R, CGG12-L, CGG12-R, CGG21-L, CGG21-R, CGG22-L, CGG22-R, CGG61-L, CGG61-R, CGG62-L, CGG62-R, CPE60, CPE63, CSE11-L, CSE11-R, CSE11-R-DG, CSE12-L, CSE12-R, CSE12-R-DG, CSE21-L, CSE21-R, CSE21-R-DG, CSE22-L, CSE22-R, CSE22-R-DG, CSE61-L, CSE61-R, CSE61-R-DG, CSE62-L, CSE62-R, CSE62-R-DG, CSG11-L, CSG11-R, CSG11-R-DG, CSG12-L, CSG12-R, CSG12-R-DG... (Other models you can see in the webshop)		



## rail-mounted terminals

WIELAND

accessories



<b>Part No.</b>	550370	<b>Ref. No.</b>	203273
<b>description</b>	terminal block end bracket clampsmm <sup>2</sup>		
<b>For models:</b>	0220302H00, 0220302H01, 0220303H00, 0220303H01, 0720332R00, 0720332V00, 1220305B00, 1220305B01, 1220305B02, 1220305B03, 1220305B04, 1220305B05, 1220305B06, 1220305B07, 1220305C00, 1220305C01, 1220305C02, 1220305C03, 1220305C04, 1220305C05, 1220305E02, 1220305E03, 1220305E04, 1220305H00, 1220305H01, 1220305H02, 1220305H03, 1220305H04, 1220305H05, 1220327-01, 1220327B01, 1220329-00, 1220329-01, 1220329B00, 1220329B01, 1223205-00, 1223205-01, 1223205-02, 1223211-00, 1320305B00, 1320305B01, 1320305B02, 1320305B03, 1320305C00, 1320305C01, 1320305C02, 1320305C03, 1320305E02, 1320305E03, 1320305H00... (Other models you can see in the webshop)		

## miscellaneous



<b>Part No.</b>	551377	<b>Ref. No.</b>	203634
<b>description</b>	fuse holder Phönix Control type USIG 0.5-16mm <sup>2</sup> DIN rail black W 10.2mm L 61mm for fuse holder 10A rated 500V		
<b>For models:</b>	0220302A00, 0220302A01, 0220302A02, 0220302A03, 0220302C00, 0220302C01, 0220302C02, 0220302C03, 0220302H00, 0220302H01, 0220303A00, 0220303A01, 0220303A02, 0220303A03, 0220303C00, 0220303C01, 0220303C02, 0220303H00, 0220303H01, 0220304-00, 0220305-00, 0220306-00, 0221501-00, 0221502-00, 0521702B03, 0521702B04, 0720332P00, 0720332R00, 0720332T00, 0720332V00, 1220307-00, 1220307-01, 1220308-00, 1220326-00, 1220326-01, 1220326B00, 1220326B01, 1220327-00, 1220327-01, 1220327B01, 1220329-00, 1220329-01, 1220329B00, 1220329B01, 1221112-00, 1320323-00, 1320323B00, 1320327-00, 1320327A00, 1320327A01... (Other models you can see in the webshop)		



<b>Part No.</b>	551356	<b>Ref. No.</b>	203271
<b>description</b>	rail-mounted terminal Phönix Control type UK10 6-10mm <sup>2</sup> W 8mm L 43mm max. 50A max 500V		
<b>For models:</b>	0220303B00, 0220303B01, 0220303C00, 0220303C01, 0220303C02, 0220303E00, 0220303E01, 0220306-00, 0521702B03, 0521702B04, 0720332P00, 0720332R00, 0720332T00, 0720332V00, 1120510-00, 1120510-01, 1220307-00, 1220307-01, 1220308-00, 1220326-00, 1220326-01, 1220326B00, 1220326B01, 1220503-00, 1221112-00, 1223204-00, 1223204-01, 1223204-02, 1223205-00, 1223205-01, 1223205-02, 1223206-00, 1223206-01, 1223206-02, 1223211-00, 1223212-00, 1223214-00, 1323211-00, 1323211-01, 1420332P01, 1420332P02, 1420332P03, 1420332R00, 1420332R01, 1420332R02, 1420332R03, 1420332T01, 1420332T02, 1420332T03, 1420332V01... (Other models you can see in the webshop)		

1

<b>Part No.</b>		<b>Ref. No.</b>	203620
<b>description</b>	rail-mounted terminal Phönix Control type UK16 0.5-16mm <sup>2</sup> top-hat rail 35mm grey W 10.2mm L 42.5mm		
<b>For models:</b>	0221502-00, 0720332P00, 0720332R00, 0720332T00, 0720332V00, 1420332P01, 1420332P02, 1420332P03, 1420332R00, 1420332R01, 1420332R02, 1420332R03, 1420332T01, 1420332T02, 1420332T03, 1420332V01, 1420332V02, 1420332V03, 1420333P01, 1420333P02, 1420333R00, 1420333R01, 1420333R02, 1420333T01, 1420333T02, 1420333V01, 1420333V02, 1420334P00, 1420334P01, 1420334P02, 1420334P03, 1420334P04, 1420334R02, 1420334R03, 1420334R04, 1420334T02, 1420334T03, 1420334T04, 1420334V01, 1420334V02, 1420334V03, 1420334V04, 1420334W02, 1420334W03, 1420334W04, 1420334Y02, 1420334Y03, 1420334Y04, 1420344R00, 1420344R01... (Other models you can see in the webshop)		


1


<b>Part No.</b>	551375	<b>Ref. No.</b>	203622
<b>description</b>	rail-mounted terminal Phönix Control type UK35 0.75-35mm <sup>2</sup> DIN rail grey W 15.1mm L 62mm		
<b>For models:</b>	1422802B04, 1422802B05, 1422802B06, 1422802B07, 1422802B08, 1422804B04, 1422804B05, 1422804B06, 1422804B07, 1422804B08, 1422805B04, 1422805B05, 1422805B06, 1422805B07, 1422805B08, 1422807B00, 1422807B01, 1422807B02, 1422807B03, 1422807B04, 1422902-00, 1422902-01, 1422902-02, 1422902-03, 1422902-04, 2020308-00, 2020314-01, 2020314A01, 2020315-01, 2020315A01, 2021123A00, 2021411-00, 2021412C00, 2021413-00, 2021413B00, 2021415B00, 2021416B00, 2021417-00, 2021417B00, 2021418B00, 2021419-00, 2021419B00, 2022801-02, 2022801-03, 2022801A02, 2022801A03, 2022801B02, 2022801B03, 2022801C02, 2022801C03... (Other models you can see in the webshop)		

1


<b>Part No.</b>	551371	<b>Ref. No.</b>	203279
<b>description</b>	rail-mounted terminal Phönix Control type USLKG10 0.5-10mm <sup>2</sup> yellow/green for DIN rail 35mm H 45mm 1-pole		
<b>For models:</b>	0220303B00, 0220303B01, 0220303C00, 0220303C01, 0220303C02, 0220303E00, 0220303E01, 0220306-00, 0521702B03, 0521702B04, 0720332P00, 0720332R00, 0720332T00, 0720332V00, 1120510-00, 1120510-01, 1220303A00, 1220303A01, 1220303A02, 1220303C00, 1220303C01, 1220303C02, 1220303F01, 1220303F02, 1220303F03, 1220303H00, 1220303H01, 1220303H02, 1220303H03, 1220305A00, 1220305A01, 1220305A02, 1220305A03, 1220305A04, 1220305A05, 1220305B03, 1220305B04, 1220305B05, 1220305B06, 1220305B07, 1220305C04, 1220305C05, 1220305E03, 1220305E04, 1220305F01, 1220305F02, 1220305F03, 1220305F04, 1220305F05, 1220305K00... (Other models you can see in the webshop)		



			
1			
<b>Part No.</b>	551374	<b>Ref. No.</b>	203621
<b>description</b>	rail-mounted terminal Phönix Control type USLKG16 0.5-16mm <sup>2</sup> yellow/green W 10.2mm L 42.5mm for DIN rail 35mm H 45mm 1-pole		
<b>For models:</b>	0720332P00, 0720332R00, 0720332T00, 0720332V00, 1420332P01, 1420332P02, 1420332P03, 1420332R00, 1420332R01, 1420332R02, 1420332R03, 1420332T01, 1420332T02, 1420332T03, 1420332V01, 1420332V02, 1420332V03, 1420333P01, 1420333P02, 1420333R00, 1420333R01, 1420333R02, 1420333T01, 1420333T02, 1420333V01, 1420333V02, 1420334P00, 1420334P01, 1420334P02, 1420334P03, 1420334P04, 1420334R02, 1420334R03, 1420334R04, 1420334T02, 1420334T03, 1420334T04, 1420334V01, 1420334V02, 1420334V03, 1420334V04, 1420334W02, 1420334W03, 1420334W04, 1420334Y02, 1420334Y03, 1420334Y04, 1420344R00, 1420344R01, 1420344R02... (Other models you can see in the webshop)		

			
1			
<b>Part No.</b>	551376	<b>Ref. No.</b>	203633
<b>description</b>	rail-mounted terminal Phönix Control type USLKG35 0.75-35mm <sup>2</sup> DIN rail yellow/green W 15mm L 50mm for DIN rail 35mm H 62mm 1-pole		
<b>For models:</b>	1422802B04, 1422802B05, 1422802B06, 1422802B07, 1422802B08, 1422804B04, 1422804B05, 1422804B06, 1422804B07, 1422804B08, 1422805B04, 1422805B05, 1422805B06, 1422805B07, 1422805B08, 1422807B00, 1422807B01, 1422807B02, 1422807B03, 1422807B04, 1422902-00, 1422902-01, 1422902-02, 1422902-03, 1422902-04, 2020308-00, 2020314-01, 2020314A01, 2020315-01, 2020315A01, 2021123A00, 2021411-00, 2021412C00, 2021413-00, 2021413B00, 2021415B00, 2021416B00, 2021417-00, 2021417B00, 2021418B00, 2021419-00, 2021419B00, 2022801-02, 2022801-03, 2022801A02, 2022801A03, 2022801B02, 2022801B03, 2022801C02, 2022801C03... (Other models you can see in the webshop)		

## electronic magnets

			
1			
<b>Part No.</b>	400793	<b>Ref. No.</b>	203672
<b>description</b>	lifting magnet 205V voltage DC		
<b>For models:</b>	CCE60, CCE63, CGE11-L, CGE11-R, CGE12-L, CGE12-R, CGE21-L, CGE21-R, CGE22-L, CGE22-R, CGE61-L, CGE61-R, CGE62-L, CGE62-R, CGG11-L, CGG11-R, CGG12-L, CGG12-R, CGG21-L, CGG21-R, CGG22-L, CGG22-R, CGG61-L, CGG61-R, CGG62-L, CGG62-R, CPE60, CPE63, CSE11-L, CSE11-R, CSE11-R-DG, CSE12-L, CSE12-R, CSE12-R-DG, CSE21-L, CSE21-R, CSE21-R-DG, CSE22-L, CSE22-R, CSE22-R-DG, CSE61-L, CSE61-R, CSE61-R-DG, CSE62-L, CSE62-R, CSE62-R-DG, CSG11-L, CSG11-R, CSG11-R-DG, CSG12-L... (Other models you can see in the webshop)		

## gas taps

### PEL

#### 22S/V series


























				
1				
<b>Part No.</b>	101457	<b>Ref. No.</b>	201515 Alternativ	
<b>description</b>	gas tap alternatives to JUNKERS type CH110 gas inlet M20x1.5 (tube ø 12mm) bypass nozzle ø 0.35mm gas outlet M20x1.5 (tube ø 12/10mm) thermocouple connection M8x1 pilot connection M10x1 shaft ø 10mm shaft L 25mm shaft flat with pipe outlet			
<b>spare parts for</b>	101457			
	<b>Part No.</b>	100259	<b>Ref. No.</b>	—
	bypass nozzle type PEL22 bore ø 0.35mm thread M6x0.5			
	<b>Part No.</b>	100908	<b>Ref. No.</b>	—
	union screw thread M10x1 for pipe ø 4mm Qty 1 pcs			
	<b>Part No.</b>	101058	<b>Ref. No.</b>	201526
	magnet unit L 39mm D1 ø 15.4mm D2 ø 13.5mm suitable for PEL22/ EGA24197 standard			
	<b>Part No.</b>	101200	<b>Ref. No.</b>	—
	gas tap front part shaft ø 10mm shaft L 25mm shaft flat suitable for 22S/O			
	<b>Part No.</b>	101230	<b>Ref. No.</b>	—
	thermocouple nut T1: M8x1 T2: M18x1 aluminium			
	<b>Part No.</b>	101241	<b>Ref. No.</b>	—
	gas connection thread M20x1.5 tube ø 12/10mm for PEL gas taps vertical			
	<b>Part No.</b>	101246	<b>Ref. No.</b>	—
	olive for pipe ø 4mm Qty 1 pcs			
	<b>Part No.</b>	101460	<b>Ref. No.</b>	—
	O-ring ø 12.37mm D1 ø 2.62mm suitable for PEL22			
	<b>Part No.</b>	101461	<b>Ref. No.</b>	—
	screw kit suitable for PEL22 Qty 4 pcs			
<b>accessories for</b>	101457			
	<b>Part No.</b>	100945	<b>Ref. No.</b>	—
	roll pin ø 3.2mm L 10mm			
	<b>Part No.</b>	101218	<b>Ref. No.</b>	—
	shaft extension JUNKERS			
	<b>Part No.</b>	101219	<b>Ref. No.</b>	—
	shaft extension L 25mm JUNKERS			
	<b>Part No.</b>	101231	<b>Ref. No.</b>	—
	thermocouple nut T1: M9x1 T2: M18x1			
	<b>Part No.</b>	101248	<b>Ref. No.</b>	—
	olive for pipe ø 12mm Qty 1 pcs suitable for PEL			

Table continues overleaf



accessories for		101457	
	Part No.	101249	Ref. No. —
	olive for pipe ø 10mm Qty 1 pcs		
	Part No.	101250	Ref. No. —
	union nut thread M20x1.5 for pipe ø 10mm		
	Part No.	101251	Ref. No. —
	union nut thread M20x1.5 for pipe ø 12mm		
	Part No.	101290	Ref. No. —
	thermocouple nut T1: M10x1 T2: M18x1 suitable for PEL20/21		
	Part No.	110064	Ref. No. —
	knob		
	Part No.	110066	Ref. No. —
	knob screw		
	Part No.	550396	Ref. No. 204109
	shaft extension L 25mm JUNKERS		

			
1			
Part No.	101793	Ref. No.	201163
description	gas tap PEL type 225/V gas inlet M20x1.5 (tube ø 12mm) bypass nozzle ø 0.9mm gas outlet M20x1.5 (tube ø 12/10mm) thermocouple connection M8x1 pilot connection M10x1 shaft ø 6x4.6mm shaft L 45/20mm shaft flat upper		
For models:	1261301-02, 1261602-02, 1261602-03, 1261604-03, 1263405-01, 1361301-03, 1361602-01, 1361602-02, 1361604-02, 1363405-01, 1461602-00, 1463501-05, 2061301-01, 2061602-00, 2061602-01, 2061603-02, 2061604-01, 2063501-06, 2063502-10, 2063503-07, 3061602-00, 3063501-04		
spare parts for		101793	
	Part No.	100433	Ref. No. 201164
	bypass nozzle type PEL22 bore ø 0.9mm thread M6x0.5		
	Part No.	100908	Ref. No. —
	union screw thread M10x1 for pipe ø 4mm Qty 1 pcs		
	Part No.	101058	Ref. No. 201526
	magnet unit L 39mm D1 ø 15.4mm D2 ø 13.5mm suitable for PEL22/ EGA24197 standard		
	Part No.		Ref. No. —
	gas tap spindle for gas tap suitable for PEL22		
	Part No.	101230	Ref. No. —
	thermocouple nut T1: M8x1 T2: M18x1 aluminium		
	Part No.	101241	Ref. No. —
	gas connection thread M20x1.5 tube ø 12/10mm for PEL gas taps vertical		
	Part No.	101246	Ref. No. —
	olive for pipe ø 4mm Qty 1 pcs		

spare parts for		101793	
	Part No.	101460	Ref. No. —
	O-ring ø 12.37mm D1 ø 2.62mm suitable for PEL22		
	Part No.	101461	Ref. No. —
	screw kit suitable for PEL22 Qty 4 pcs		
accessories for		101793	
	Part No.	100908	Ref. No. —
	union screw thread M10x1 for pipe ø 4mm Qty 1 pcs		
	Part No.	100909	Ref. No. —
	union screw thread M10x1 for pipe ø 6mm Qty 1 pcs		
	Part No.	101240	Ref. No. —
	gas connection thread M20x1.5 tube ø 12/10mm for PEL gas taps with gasket and screws horizontal		
	Part No.	101246	Ref. No. —
	olive for pipe ø 4mm Qty 1 pcs		
	Part No.	101248	Ref. No. —
	olive for pipe ø 12mm Qty 1 pcs suitable for PEL		
	Part No.	101249	Ref. No. —
	olive for pipe ø 10mm Qty 1 pcs		
	Part No.	101250	Ref. No. —
	union nut thread M20x1.5 for pipe ø 10mm		
	Part No.	101251	Ref. No. —
	union nut thread M20x1.5 for pipe ø 12mm		
	Part No.	101286	Ref. No. 201571
	olive ID ø 6mm Qty 1 pcs		


















23S/V series



1

<b>Part No.</b>	101630	<b>Ref. No.</b>	201516 201516 Alternativ
<b>description</b>	gas tap PEL type 23S/V gas inlet 1/2" IT bypass nozzle ø 0.35mm gas outlet 1/2" MT (tube ø 14mm) thermocouple connection M10x1 pilot connection M10x1 shaft ø 10mm shaft L 25mm shaft flat		
<b>For models:</b>	1463501-01, 1463501-02, 2061401-00, 2061401-01, 2061401A00, 2061401B00, 2061401C00, 2061402-00, 2061402-01, 2061402A00, 2061402B00, 2061402C00, 2062801-00, 2062801A00, 2062801B00, 2062801C00, 2062802-00, 2062802-01, 2062802-2, 2062802A00, 2062802B00, 2062802C00, 2062803-00, 2062803-01, 2062803-2, 2062803A00, 2062803B00, 2062803C00, 2062804-00, 2062804-01, 2062804-2, 2062804A00, 2062804B00, 2062804C00, 2062806-00, 2062806A00, 2062806B00, 2062806B01, 2062806B02, 2062806B03, 2062806C00, 2062806C01, 2062806C02, 2062806C03, 20629011-00, 20629011-1... (Other models you can see in the webshop)		
<b>spare parts for</b>	101630		
	<b>Part No.</b>	100455	<b>Ref. No.</b> —
	bypass nozzle type PEL23/24 bore ø 0.35mm thread M8x0.5		
	<b>Part No.</b>	101059	<b>Ref. No.</b> —
	magnet unit T1: M10x1 T2: M22x1 L 46mm ø 18mm suitable for PEL23S M10x1		
	<b>Part No.</b>	102767	<b>Ref. No.</b> —
	gas tap front part shaft ø 10mm shaft L 26.5mm shaft flat suitable for PEL23S		
<b>accessories for</b>	101630		
	<b>Part No.</b>	100908	<b>Ref. No.</b> —
	union screw thread M10x1 for pipe ø 4mm Qty 1 pcs		
	<b>Part No.</b>	100909	<b>Ref. No.</b> —
	union screw thread M10x1 for pipe ø 6mm Qty 1 pcs		
	<b>Part No.</b>	100945	<b>Ref. No.</b> —
	roll pin ø 3.2mm L 10mm		
	<b>Part No.</b>	101218	<b>Ref. No.</b> —
	shaft extension JUNKERS		
	<b>Part No.</b>	101219	<b>Ref. No.</b> —
	shaft extension L 25mm JUNKERS		
	<b>Part No.</b>	101246	<b>Ref. No.</b> —
	olive for pipe ø 4mm Qty 1 pcs		
	<b>Part No.</b>	101286	<b>Ref. No.</b> 201571
	olive ID ø 6mm Qty 1 pcs		
	<b>Part No.</b>	110064	<b>Ref. No.</b> —
	knob		
	<b>Part No.</b>	110066	<b>Ref. No.</b> —
	knob screw		

<b>accessories for</b>	101630		
	<b>Part No.</b>	550396	<b>Ref. No.</b> 204109
	shaft extension L 25mm JUNKERS		

alternatives to EGA

GPEL21 series

with nozzle outlet



1

<b>Part No.</b>	106576	<b>Ref. No.</b>	201137
<b>description</b>	gas tap alternatives to EGA type GPEL21D gas inlet M15x1 (tube ø 10mm) external nozzle ø 1.55mm internal nozzle ø 1.35mm bypass nozzle ø 0.4mm mixing pipe connection thermocouple connection M8x1 pilot connection M10x1 shaft ø 6x4.6mm shaft L 30/23mm shaft flat upper		



1
















<b>Part No.</b>	101663	<b>Ref. No.</b>	201148
<b>description</b>	gas tap alternatives to EGA type GPEL21D gas inlet M15x1 (tube ø 10mm) external nozzle ø 2.05mm internal nozzle ø 1.85mm bypass nozzle ø 0.5mm mixing pipe connection thermocouple connection M8x1 pilot connection M10x1 shaft ø 6x4.6mm shaft L 31/23mm shaft flat upper		
<b>spare parts for</b>	101663		
	<b>Part No.</b>	100060	<b>Ref. No.</b> —
	pilot burner JUNKERS type CB505070 2 flames natural gas nozzle no.4 gas connection 4mm with primary air		
	<b>Part No.</b>	100244	<b>Ref. No.</b> 201837
	internal nozzle bore ø 1.85mm suitable for EGA 23268,26400,26440		
	<b>Part No.</b>	100303	<b>Ref. No.</b> 201836
	gas injector thread M12x1 WS 14 bore ø 2.05mm		
	<b>Part No.</b>	100408	<b>Ref. No.</b> —
	bypass nozzle type PEL20/21 bore ø 0.35mm thread M5x0.5		
	<b>Part No.</b>	100908	<b>Ref. No.</b> —
	union screw thread M10x1 for pipe ø 4mm Qty 1 pcs		
	<b>Part No.</b>	100926	<b>Ref. No.</b> —
	centring piece thread M17x1		
	<b>Part No.</b>	100927	<b>Ref. No.</b> —
	torsion spring L 2.8-8.0mm for internal nozzle ø 3mm bore ømm		
	<b>Part No.</b>	100942	<b>Ref. No.</b> —
	union nut thread M15x1 for pipe ø 10mm		

Table continues overleaf










spare parts for		101663	
	Part No.	101230	Ref. No. —
	thermocouple nut T1: M8x1 T2: M18x1 aluminium		
	Part No.	101246	Ref. No. —
	olive for pipe ø 4mm Qty 1 pcs		
	Part No.	101278	Ref. No. —
	olive for pipe ø 10mm Qty 1 pcs		
	Part No.	101526	Ref. No. —
	O-ring Viton thickness 1.78mm ID ø 4.48mm Qty 1 pcs		
	Part No.	101593	Ref. No. —
	adjusting screw for internal nozzle thread M8x0.75		
	Part No.	101803	Ref. No. —
	gas tap front part shaft ø 6x4.6mm shaft L 30/23mm shaft flat upper/lower suitable for PEL21		



accessories for		101663	
	Part No.	100909	Ref. No. —
	union screw thread M10x1 for pipe ø 6mm Qty 1 pcs		
	Part No.	100942	Ref. No. —
	union nut thread M15x1 for pipe ø 10mm		
	Part No.	101278	Ref. No. —
	olive for pipe ø 10mm Qty 1 pcs		
	Part No.	101286	Ref. No. 201571
	olive ID ø 6mm Qty 1 pcs		
	Part No.	110078	Ref. No. —
	knob without symbol ø 70mm shaft ø 6x4.6mm shaft flat universal		
	Part No.	112206	Ref. No. —
	knob dial plate silver gas tap PEL21/22/23 t.max.°C ED ø 63mm ID ø 45.5mm		



1


<b>Part No.</b>	101606	<b>Ref. No.</b>	201742 Alternativ 201743 Alternativ 201830 Alternativ 201835 Alternativ
<b>description</b>	gas tap alternatives to EGA type GPEL21D with nozzle outlet (without nozzle) gas inlet M15x1 (tube ø 10mm) external nozzle ømm internal nozzle ømm bypass nozzle ø 0.35mm mixing pipe connection M17x1 thermocouple connection M8x1 pilot connection M10x1 shaft ø 6x4.6mm shaft L 31/23mm shaft flat upper		
spare parts for		101606	
	Part No.	100408	Ref. No. —
	bypass nozzle type PEL20/21 bore ø 0.35mm thread M5x0.5		
	Part No.	100927	Ref. No. —
	torsion spring L 2.8-8.0mm for internal nozzle ø 3mm bore ømm		







spare parts for		101606	
	Part No.	101060	Ref. No. 201527 201531
	magnet unit standard L 39mm D1 ø 15.4mm D2 ø 11mm suitable for PEL20-21/JUNKERS/EGA		
	Part No.	101230	Ref. No. —
	thermocouple nut T1: M8x1 T2: M18x1 aluminium		
	Part No.	101526	Ref. No. —
	O-ring Viton thickness 1.78mm ID ø 4.48mm Qty 1 pcs		
	Part No.	101593	Ref. No. —
	adjusting screw for internal nozzle thread M8x0.75		
	Part No.	101803	Ref. No. —
	gas tap front part shaft ø 6x4.6mm shaft L 30/23mm shaft flat upper/lower suitable for PEL21		





accessories for		101606	
	Part No.	100908	Ref. No. —
	union screw thread M10x1 for pipe ø 4mm Qty 1 pcs		
	Part No.	100909	Ref. No. —
	union screw thread M10x1 for pipe ø 6mm Qty 1 pcs		
	Part No.	100926	Ref. No. —
	centring piece thread M17x1		
	Part No.	100927	Ref. No. —
	torsion spring L 2.8-8.0mm for internal nozzle ø 3mm bore ømm		
	Part No.	100942	Ref. No. —
	union nut thread M15x1 for pipe ø 10mm		
	Part No.	100943	Ref. No. —
	union nut thread M17x1 tube ø 10mm		
	Part No.	101246	Ref. No. —
	olive for pipe ø 4mm Qty 1 pcs		
	Part No.	101278	Ref. No. —
	olive for pipe ø 10mm Qty 1 pcs		
	Part No.	101286	Ref. No. 201571
	olive ID ø 6mm Qty 1 pcs		
	Part No.	110078	Ref. No. —
	knob without symbol ø 70mm shaft ø 6x4.6mm shaft flat universal		
	Part No.	112206	Ref. No. —
	knob dial plate silver gas tap PEL21/22/23 t.max.°C ED ø 63mm ID ø 45.5mm		



with pipe outlet

			
1			
<b>Part No.</b>	106575	<b>Ref. No.</b>	201136
<b>description</b>	gas tap alternatives to EGA type GPEL21R gas inlet M15x1 (tube ø 10mm) bypass nozzle ø 0.6mm gas outlet M17x1 (tube ø 10mm) thermocouple connection M8x1 pilot connection M10x1 shaft ø 6x4.6mm shaft L 30/23mm shaft flat upper gas outlet M17x1 (tube ø 10mm)mm		

			
1			
<b>Part No.</b>	101605	<b>Ref. No.</b>	201737 Alternativ 201755 Alternativ 201760 Alternativ
<b>description</b>	gas tap alternatives to EGA type GPEL21R with pipe outlet gas inlet M15x1 (tube ø 10mm) bypass nozzle ø 0.35mm gas outlet M17x1 (tube ø 10mm) thermocouple connection M8x1 pilot connection M10x1 shaft ø 6x4.6mm shaft L 30/23mm shaft flat upper		
<b>spare parts for</b>	101605		
	<b>Part No.</b>	100408	<b>Ref. No.</b> —
	bypass nozzle type PEL20/21 bore ø 0.35mm thread M5x0.5		
	<b>Part No.</b>	101060	<b>Ref. No.</b> 201527 201531
	magnet unit standard L 39mm D1 ø 15.4mm D2 ø 11mm suitable for PEL20-21/JUNKERS/EGA		
	<b>Part No.</b>	101230	<b>Ref. No.</b> —
	thermocouple nut T1: M8x1 T2: M18x1 aluminium		
	<b>Part No.</b>	101803	<b>Ref. No.</b> —
	gas tap front part shaft ø 6x4.6mm shaft L 30/23mm shaft flat upper/lower suitable for PEL21		
<b>accessories for</b>	101605		
	<b>Part No.</b>	100908	<b>Ref. No.</b> —
	union screw thread M10x1 for pipe ø 4mm Qty 1 pcs		
	<b>Part No.</b>	100909	<b>Ref. No.</b> —
	union screw thread M10x1 for pipe ø 6mm Qty 1 pcs		
	<b>Part No.</b>	100926	<b>Ref. No.</b> —
	centring piece thread M17x1		
	<b>Part No.</b>	100942	<b>Ref. No.</b> —
	union nut thread M15x1 for pipe ø 10mm		
	<b>Part No.</b>	100943	<b>Ref. No.</b> —
	union nut thread M17x1 tube ø 10mm		
	<b>Part No.</b>	101246	<b>Ref. No.</b> —
	olive for pipe ø 4mm Qty 1 pcs		

<b>accessories for</b>	101605		
	<b>Part No.</b>	101278	<b>Ref. No.</b> —
	olive for pipe ø 10mm Qty 1 pcs		
	<b>Part No.</b>	101286	<b>Ref. No.</b> 201571
	olive ID ø 6mm Qty 1 pcs		
	<b>Part No.</b>	110078	<b>Ref. No.</b> —
	knob without symbol ø 70mm shaft ø 6x4.6mm shaft flat universal		
	<b>Part No.</b>	112206	<b>Ref. No.</b> —
	knob dial plate silver gas tap PEL21/22/23 t.max. °C ED ø 63mm ID ø 45.5mm		

GPEL22 series

with nozzle outlet











			
1			
<b>Part No.</b>	101622	<b>Ref. No.</b>	201740 Alternativ 201741 Alternativ
<b>description</b>	gas tap alternatives to EGA type PEL22S with nozzle outlet (without nozzle) gas inlet M18x1.5 (tube ø 12mm) external nozzle ømm internal nozzle ømm bypass nozzle ø 0.35mm mixing pipe connection M22x1 thermocouple connection M8x1 pilot connection M10x1 shaft ø 6x4.6mm shaft L 35/21mm shaft flat upper		
<b>spare parts for</b>	101622		
	<b>Part No.</b>	100259	<b>Ref. No.</b> —
	bypass nozzle type PEL22 bore ø 0.35mm thread M6x0.5		
	<b>Part No.</b>	100927	<b>Ref. No.</b> —
	torsion spring L 2.8-8.0mm for internal nozzle ø 3mm bore ømm		
	<b>Part No.</b>	101058	<b>Ref. No.</b> 201526
	magnet unit L 39mm D1 ø 15.4mm D2 ø 13.5mm suitable for PEL22/EGA24197 standard		
	<b>Part No.</b>	101230	<b>Ref. No.</b> —
	thermocouple nut T1: M8x1 T2: M18x1 aluminium		
	<b>Part No.</b>	101460	<b>Ref. No.</b> —
	O-ring ø 12.37mm D1 ø 2.62mm suitable for PEL22		
	<b>Part No.</b>	101527	<b>Ref. No.</b> —
	O-ring Viton thickness 1.78mm ID ø 6.75mm Qty 1 pcs		
	<b>Part No.</b>	101594	<b>Ref. No.</b> —
	adjusting screw for internal nozzle thread M10x0.75		
	<b>Part No.</b>	101823	<b>Ref. No.</b> —
	gas tap front part shaft ø 6x4.6mm shaft L 35/21mm shaft flat upper/lower suitable for PEL22		
<b>accessories for</b>	101622		
	<b>Part No.</b>	100908	<b>Ref. No.</b> —
	union screw thread M10x1 for pipe ø 4mm Qty 1 pcs		

Table continues overleaf



accessories for		101622		
	Part No.	100909	Ref. No.	—
	union screw thread M10x1 for pipe ø 6mm Qty 1 pcs			
	Part No.	100944	Ref. No.	—
	union nut thread M18x1.5 for pipe ø 12mm			
	Part No.	101246	Ref. No.	—
	olive for pipe ø 4mm Qty 1 pcs			
	Part No.	101273	Ref. No.	201594
	olive for pipe ø 12mm L 9.5mm brass Qty 1 pcs suitable for universal			
	Part No.	101286	Ref. No.	201571
	olive ID ø 6mm Qty 1 pcs			
	Part No.	110078	Ref. No.	—
	knob without symbol ø 70mm shaft ø 6x4.6mm shaft flat universal			
	Part No.	112206	Ref. No.	—
	knob dial plate silver gas tap PEL21/22/23 t.max.°C ED ø 63mm ID ø 45.5mm			





## with pipe outlet



1

Part No.	106396 <sup>1</sup>	Ref. No.	201786	
description	gas tap type GPEL22R with pipe outlet gas inlet M18x1.5 (tube ø 12mm) bypass nozzle ø 0.35mm gas outlet M18x1.5 (tube ø 12mm) thermocouple connection M8x1 pilot connection M10x1 shaft ø 6x4.6mm shaft L 35/21mm shaft flat upper			
For models:	2063413-02, 2063414-03, 2063415-05, 2063416-02, 2063417-03, 2063418-05, 2063419-02			
spare parts for	106396			
	Part No.	100259	Ref. No.	—
	bypass nozzle type PEL22 bore ø 0.35mm thread M6x0.5			
	Part No.	101058	Ref. No.	201526
	magnet unit L 39mm D1 ø 15.4mm D2 ø 13.5mm suitable for PEL22/ EGA24197 standard			
	Part No.	101230	Ref. No.	—
	thermocouple nut T1: M8x1 T2: M18x1 aluminium			
	Part No.	101823	Ref. No.	—
	gas tap front part shaft ø 6x4.6mm shaft L 35/21mm shaft flat upper/lower suitable for PEL22			
accessories for	106396			
	Part No.	100908	Ref. No.	—
	union screw thread M10x1 for pipe ø 4mm Qty 1 pcs			
	Part No.	100909	Ref. No.	—
	union screw thread M10x1 for pipe ø 6mm Qty 1 pcs			








<sup>1</sup>incl. union nuts and olives

accessories for		106396		
	Part No.	100944	Ref. No.	—
	union nut thread M18x1.5 for pipe ø 12mm			
	Part No.	101246	Ref. No.	—
	olive for pipe ø 4mm Qty 1 pcs			
	Part No.	101273	Ref. No.	201594
	olive for pipe ø 12mm L 9.5mm brass Qty 1 pcs suitable for universal			
	Part No.	101286	Ref. No.	201571
	olive ID ø 6mm Qty 1 pcs			

## JUNKERS







1

Part No.	nla <sup>1</sup>	Ref. No.	201515	
description	gas tap JUNKERS type CH120 gas inlet M20x1.5 bypass nozzle ø 0.35mm gas outlet M20x1.5 thermocouple connection M8x1 pilot connection M10x1 shaft ø 10mm shaft L 20.7mm shaft flat			
For models:	0260501-00, 0261101-00, 0261101-01, 0261102-00, 0261102-01, 0261103-00, 0261103-01, 0261301-00, 0261601-00, 1261301-00, 1261301-01, 1261601-00, 1261601-01, 1261602-00, 1261602-01, 1263405-00, 1361301-00, 1361301-01, 1361301-02, 1361601-00, 1361601-01, 1361601-02, 1361602-00, 1363405-00, 1461601-00, 1463501-00, 1463501-03, 1463501-04, 20611011-0, 20611022-0, 20611033-0, 2061104-00, 20611044-0, 2061105-00, 20611055-0, 2061106-00, 20611066-0, 2061603-00, 2061603-01, 2063501-00, 2063501-05, 20635011-0, 2063502-00, 2063502-09, 20635022-0, 2063503-00, 2063503-05, 2063503-06, 20635033-0, 2063504-00... (Other models you can see in the webshop)			
spare parts for	106396			
	Part No.	101060	Ref. No.	201527 201531
	magnet unit standard L 39mm D1 ø 15.4mm D2 ø 11mm suitable for PEL20-21/JUNKERS/EGA			
	Part No.	101230	Ref. No.	—
	thermocouple nut T1: M8x1 T2: M18x1 aluminium			
	Part No.	345200	Ref. No.	—
	microswitch with plunger			
accessories for	106396			
	Part No.	100945	Ref. No.	—
	roll pin ø 3.2mm L 10mm			
	Part No.	101219	Ref. No.	—
	shaft extension L 25mm JUNKERS			
	Part No.	101281	Ref. No.	201560
	olive for pipe ø 4mm L 8.7mm Qty 1 pcs suitable for CB 502/503			
	Part No.	101284	Ref. No.	201827
	olive for pipe ø 4mm Qty 1 pcs			

<sup>1</sup>no longer available  
Table continues overleaf





accessories for				
	Part No.	101285	Ref. No.	—
union screw thread M8x1 for pipe ø 4mm Qty 1 pcs JUNKERS				
	Part No.	110064	Ref. No.	—
knob				
	Part No.	110066	Ref. No.	—
knob screw				
	Part No.	550396	Ref. No.	204109
shaft extension L 25mm JUNKERS				

alternatives to JUNKERS

 <p>1</p>				
Part No.	101457	Ref. No.	201515 Alternativ	
description	gas tap alternatives to JUNKERS type CH110 gas inlet M20x1.5 (tube ø 12mm) bypass nozzle ø 0.35mm gas outlet M20x1.5 (tube ø 12/10mm) thermocouple connection M8x1 pilot connection M10x1 shaft ø 10mm shaft L 25mm shaft flat with pipe outlet			
spare parts for 101457				
	Part No.	100259	Ref. No.	—
bypass nozzle type PEL22 bore ø 0.35mm thread M6x0.5				
	Part No.	100908	Ref. No.	—
union screw thread M10x1 for pipe ø 4mm Qty 1 pcs				
	Part No.	101058	Ref. No.	201526
magnet unit L 39mm D1 ø 15.4mm D2 ø 13.5mm suitable for PEL22/EGA24197 standard				
	Part No.	101200	Ref. No.	—
gas tap front part shaft ø 10mm shaft L 25mm shaft flat suitable for 22S/O				
	Part No.	101230	Ref. No.	—
thermocouple nut T1: M8x1 T2: M18x1 aluminium				
	Part No.	101241	Ref. No.	—
gas connection thread M20x1.5 tube ø 12/10mm for PEL gas taps vertical				
	Part No.	101246	Ref. No.	—
olive for pipe ø 4mm Qty 1 pcs				
	Part No.	101460	Ref. No.	—
O-ring ø 12.37mm D1 ø 2.62mm suitable for PEL22				
	Part No.	101461	Ref. No.	—
screw kit suitable for PEL22 Qty 4 pcs				
accessories for 101457				
	Part No.	100945	Ref. No.	—
roll pin ø 3.2mm L 10mm				

accessories for 101457				
	Part No.	101218	Ref. No.	—
shaft extension JUNKERS				
	Part No.	101219	Ref. No.	—
shaft extension L 25mm JUNKERS				
	Part No.	101231	Ref. No.	—
thermocouple nut T1: M9x1 T2: M18x1				
	Part No.	101248	Ref. No.	—
olive for pipe ø 12mm Qty 1 pcs suitable for PEL				
	Part No.	101249	Ref. No.	—
olive for pipe ø 10mm Qty 1 pcs				
	Part No.	101250	Ref. No.	—
union nut thread M20x1.5 for pipe ø 10mm				
	Part No.	101251	Ref. No.	—
union nut thread M20x1.5 for pipe ø 12mm				
	Part No.	101290	Ref. No.	—
thermocouple nut T1: M10x1 T2: M18x1 suitable for PEL20/21				
	Part No.	110064	Ref. No.	—
knob				
	Part No.	110066	Ref. No.	—
knob screw				
	Part No.	550396	Ref. No.	204109
shaft extension L 25mm JUNKERS				



 <p>1</p>				
Part No.	101630	Ref. No.	201516 201516 Alternativ	
description	gas tap PEL type 23S/V gas inlet 1/2" IT bypass nozzle ø 0.35mm gas outlet 1/2" MT (tube ø 14mm) thermocouple connection M10x1 pilot connection M10x1 shaft ø 10mm shaft L 25mm shaft flat			
For models:	1463501-01, 1463501-02, 2061401-00, 2061401-01, 2061401A00, 2061401B00, 2061401C00, 2061402-00, 2061402-01, 2061402A00, 2061402B00, 2061402C00, 2062801-00, 2062801A00, 2062801B00, 2062801C00, 2062802-00, 20628022-0, 20628022-1, 20628022-2, 2062802A00, 2062802B00, 2062802C00, 2062803-00, 20628033-0, 20628033-1, 20628033-2, 2062803A00, 2062803B00, 2062803C00, 2062804-00, 20628044-0, 20628044-1, 20628044-2, 2062804A00, 2062804B00, 2062804C00, 2062806-00, 2062806A00, 2062806B00, 2062806B01, 2062806B02, 2062806B03, 2062806C00, 2062806C01, 2062806C02, 2062806C03, 2062901-00, 20629011-0, 20629011-1... (Other models you can see in the webshop)			
spare parts for 101630				
	Part No.	100455	Ref. No.	—
bypass nozzle type PEL23/24 bore ø 0.35mm thread M8x0.5				

Table continues overleaf










spare parts for		101630	
	Part No.	101059	Ref. No. —
	magnet unit T1: M10x1 T2: M22x1 L 46mm ø 18mm suitable for PEL23S M10x1		
	Part No.	102767	Ref. No. —
	gas tap front part shaft ø 10mm shaft L 26.5mm shaft flat suitable for PEL23S		
accessories for		101630	
	Part No.	100908	Ref. No. —
	union screw thread M10x1 for pipe ø 4mm Qty 1 pcs		
	Part No.	100909	Ref. No. —
	union screw thread M10x1 for pipe ø 6mm Qty 1 pcs		
	Part No.	100945	Ref. No. —
	roll pin ø 3.2mm L 10mm		
	Part No.	101218	Ref. No. —
	shaft extension JUNKERS		
	Part No.	101219	Ref. No. —
	shaft extension L 25mm JUNKERS		
	Part No.	101246	Ref. No. —
	olive for pipe ø 4mm Qty 1 pcs		
	Part No.	101286	Ref. No. 201571
	olive ID ø 6mm Qty 1 pcs		
	Part No.	110064	Ref. No. —
	knob		
	Part No.	110066	Ref. No. —
	knob screw		
	Part No.	550396	Ref. No. 204109
	shaft extension L 25mm JUNKERS		

## EGA








## 24197 series








## gas taps

1

Part No.	Ref. No.	201740	201741
description		gas tap EGA type 24197 series	
For models:		0263401-00, 0263401-01, 2063413-00, 2063413-01, 2063414-00, 2063414-01, 2063414-02, 2063415-00, 2063415-01, 2063415-02, 2063415-03, 2063415-04, 2063416-00, 2063416-01, 2063417-00, 2063417-01, 2063417-02, 2063418-00, 2063418-01, 2063418-02, 2063418-03, 2063418-04, 2063419-00, 2063419-01, 2163415-00, 2163416-00, 2163416-01, 2163417-00, 2163417-01, 2163417-02, 2163417-03, 2163418-00, 2163418-01, 2163419-00, 2163419-01, 2163420-00, 2163420-01, 2163420-02, 2163420-03, 2163421-00, 2163421-01, 3063413-00, 3063414-00, 3063417-00	
spare parts for			
	Part No.	101058	Ref. No. 201526
	magnet unit L 39mm D1 ø 15.4mm D2 ø 13.5mm suitable for PEL22/ EGA24197 standard		
accessories for			
	Part No.	100944	Ref. No. —
	union nut thread M18x1.5 for pipe ø 12mm		
	Part No.	101273	Ref. No. 201594
	olive for pipe ø 12mm L 9.5mm brass Qty 1 pcs suitable for universal		
	Part No.	101284	Ref. No. 201827
	olive for pipe ø 4mm Qty 1 pcs		
	Part No.	101285	Ref. No. —
	union screw thread M8x1 for pipe ø 4mm Qty 1 pcs JUNKERS		



26440 series			
gas taps			
1			
<b>Part No.</b>		<b>Ref. No.</b>	201742 201743 201830 201835
<b>description</b>	gas tap EGA type 26440 series		
<b>For models:</b>	1464802-01, 1464803-01, 1464803-02, 1464808-01, 1464808-02, 1464809-01, 1464809-02, 1464810-01, 1464811-01, 2063401-00, 2063401-01, 2063401-02, 2063401-03, 2063401-04, 20634011-0, 2063402-00, 2063402-01, 2063402-02, 2063402-03, 2063402-04, 20634022-0, 2063403-00, 2063403-01, 2063403-02, 2063403-03, 2063403-04, 2063403-05, 2063403-06, 2063403-07, 2063403-08, 2063404-00, 2063404-01, 2063404-02, 2063404-03, 2063404-04, 2063404-05, 2063405-00, 2063405-01, 2063405-02, 2063405-03, 2063405-04, 20634055-0, 2063406-00, 2063406-01, 2063406-02, 2063406-03, 2063406-04, 2063406-05, 2063406-06, 2063406-07... (Other models you can see in the webshop)		
<b>spare parts for</b>			
	<b>Part No.</b>	101060	<b>Ref. No.</b> 201527 201531
	magnet unit standard L 39mm D1 ø 15.4mm D2 ø 11mm suitable for PEL20-21/JUNKERS/EGA		
<b>accessories for</b>			
	<b>Part No.</b>	100926	<b>Ref. No.</b> —
	centring piece thread M17x1		
	<b>Part No.</b>	100942	<b>Ref. No.</b> —
	union nut thread M15x1 for pipe ø 10mm		
	<b>Part No.</b>	101278	<b>Ref. No.</b> —
	olive for pipe ø 10mm Qty 1 pcs		
	<b>Part No.</b>	101284	<b>Ref. No.</b> 201827
	olive for pipe ø 4mm Qty 1 pcs		
	<b>Part No.</b>	101285	<b>Ref. No.</b> —
	union screw thread M8x1 for pipe ø 4mm Qty 1 pcs JUNKERS		
	<b>Part No.</b>	101394	<b>Ref. No.</b> —
	nut thread M17x1 H 3mm WS 19 brass Qty 1 pcs		

1			
<b>Part No.</b>		<b>Ref. No.</b>	201760
<b>description</b>	gas tap EGA type 26440 series		
<b>For models:</b>	1263401-00, 1263402-00, 1263404-00, 1363401-00, 1363402-00, 1363402-01, 1363403-00, 1363403-01, 1363403-02, 1363403-03, 1363404-00, 1363404-01, 1464803-02, 1464808-02, 1464809-02, 2063401-03, 2063401-04, 2063402-04, 2063403-07, 2063403-08, 2063404-04, 2063404-05, 2063405-04, 2063406-07, 2063406-08, 2063407-04, 2063407-05, 3063401-02, 3063402-02, 3063405-02		
<b>spare parts for</b>			
	<b>Part No.</b>	101060	<b>Ref. No.</b> 201527 201531
	magnet unit standard L 39mm D1 ø 15.4mm D2 ø 11mm suitable for PEL20-21/JUNKERS/EGA		
<b>accessories for</b>			
	<b>Part No.</b>	100926	<b>Ref. No.</b> —
	centring piece thread M17x1		
	<b>Part No.</b>	100942	<b>Ref. No.</b> —
	union nut thread M15x1 for pipe ø 10mm		
	<b>Part No.</b>	101278	<b>Ref. No.</b> —
	olive for pipe ø 10mm Qty 1 pcs		
	<b>Part No.</b>	101284	<b>Ref. No.</b> 201827
	olive for pipe ø 4mm Qty 1 pcs		
	<b>Part No.</b>	101285	<b>Ref. No.</b> —
	union screw thread M8x1 for pipe ø 4mm Qty 1 pcs JUNKERS		
	<b>Part No.</b>	101394	<b>Ref. No.</b> —
	nut thread M17x1 H 3mm WS 19 brass Qty 1 pcs		









1			
<b>Part No.</b>		<b>Ref. No.</b>	201737 201755
<b>description</b>	gas tap EGA type 26440 series		
<b>For models:</b>	1261101-00, 1261101-01, 1261102-00, 1261102-01, 1361101-00, 1361101-01, 1361101-02, 1361102-00, 1361102-01, 1361102-02, 1461101-01, 1461102-01, 1461104-01, 1461104-02, 1461105-01, 1461105-02, 1461109-01, 1461109A01, 1461109A02, 2061101-01, 2061101-02, 2061102-01, 2061102-02, 2061107-00, 2061107-01, 2061107A00, 2061107A01, 2161101-01, 2161101-02, 2161102-01, 2161102-02, 3061101-00, 3061102-00, 3061107-00, 3061107A00		
<b>spare parts for</b>			
	<b>Part No.</b>	101060	<b>Ref. No.</b> 201527 201531
	magnet unit standard L 39mm D1 ø 15.4mm D2 ø 11mm suitable for PEL20-21/JUNKERS/EGA		
	<b>Part No.</b>	101230	<b>Ref. No.</b> —
	thermocouple nut T1: M8x1 T2: M18x1 aluminium		

Table continues overleaf



accessories for				
	Part No.	100926	Ref. No.	—
	centring piece thread M17x1			
	Part No.	100942	Ref. No.	—
	union nut thread M15x1 for pipe ø 10mm			
	Part No.	101278	Ref. No.	—
	olive for pipe ø 10mm Qty 1 pcs			
	Part No.	101284	Ref. No.	201827
	olive for pipe ø 4mm Qty 1 pcs			
	Part No.	101285	Ref. No.	—
	union screw thread M8x1 for pipe ø 4mm Qty 1 pcs JUNKERS			
	Part No.	101394	Ref. No.	—
	nut thread M17x1 H 3mm WS 19 brass Qty 1 pcs			









## gas thermostats

### SIT

#### 710 Minisit series



Part No.	106038	Ref. No.	201591	
description	gas thermostat SIT type MINISIT 710 t.max. 100°C 30-100°C pressure controller yes			
For models:	1460503-01, 2060501-00, 2060501-01, 20605011-0, 2160501-00, 2160501-01			
spare parts for	106038			
	Part No.	100908	Ref. No.	—
	union screw thread M10x1 for pipe ø 4mm Qty 1 pcs			
	Part No.	101136	Ref. No.	201535
	piezoelectric igniter suitable for Minisit with cover cap ømm connection F6.3x0.8			
	Part No.	101284	Ref. No.	201827
	olive for pipe ø 4mm Qty 1 pcs			
	Part No.	107564	Ref. No.	—
	piezoelectric igniter body plastic blowing connection F6.3x0.8 ø 22mm			
accessories for	106038			
	Part No.	110068	Ref. No.	—
	knob suitable for Minisit ø 37mm			

	Part No.	106037 <sup>1</sup>	Ref. No.	201543
description	gas thermostat SIT type MINISIT 710 t.max. 200°C 60-200°C gas inlet 3/8" gas outlet 3/8" thermocouple connection M10x1 pilot connection M10x1 probe ø 5mm probe L 100mm capillary pipe 1150mm probe type type D2 pressure controller yes pressure regulator 3-18mbar gland nut M14x1.5			
For models:	0260301-01, 0260302-01, 1260301-00, 1260301-01, 1260302-00, 1260302-01, 1460302-00, 1460302-01, 1460302-02, 2060301-00, 2060301-01, 2060301-02			
spare parts for	106037			
	Part No.	100809	Ref. No.	—
	O-ring EPDM thickness 2mm ID ø 21mm Qty 1 pcs			
	Part No.	101054	Ref. No.	—
	magnet unit T1: M10x1 T2: M24x1 L 45mm ø 17mm suitable for Minisit			
	Part No.	101136	Ref. No.	201535
	piezoelectric igniter suitable for Minisit with cover cap ømm connection F6.3x0.8			
	Part No.	101505	Ref. No.	—
	gas connection thread 3/8" angled without O-ring MINISIT 710			
	Part No.	101516	Ref. No.	—
	flat-headed bolt thread M4 thread L 16mm SS DIN 7985/ISO 7045 Qty 1 pcs			
	Part No.	110068	Ref. No.	—
	knob suitable for Minisit ø 37mm			
accessories for	106037			
	Part No.	102844	Ref. No.	—
	probe 60-200°C probe ø 5mm probe L 98mm capillary pipe 1050mm t.max. 200°C fryer probe type type D2 suitable for MINISIT 710 gland nut M14x1.5			

<sup>1</sup>gland box M14x1,5



			
<b>Part No.</b>	106018	<b>Ref. No.</b>	201564
<b>description</b>	gas thermostat SIT type MINISIT 710 t.max. 340°C 120-340°C gas inlet 1/2" gas outlet 3/8" thermocouple connection M10x1 pilot connection M10x1 probe ø 5mm probe L 68mm capillary pipe 1050mm probe type type B1 pressure controller yes pressure regulator 15-30mbar gland nut		
<b>For models:</b>	1461101-00, 1461102-00, 1461103-00, 1462101-01, 1462101-02, 1462101-03, 1462101-04, 1462102-00, 1462102-01, 1462102-02, 1462102-03, 2061101-00, 2061102-00, 2061103-00, 2061401-02, 2061401-03, 2061401-04, 2061401A01, 2061401A02, 2061401A03, 2061401B01, 2061401B02, 2061401B03, 2061401C01, 2061401C02, 2061401C03, 2061402-02, 2061402-03, 2061402-04, 2061402A01, 2061402A02, 2061402A03, 2061402B01, 2061402B02, 2061402B03, 2061402C01, 2061402C02, 2061402C03, 2063404-01, 2063404-02, 2063404-03, 2063404-04, 2063404-05, 2063404-06, 2063404-07, 2063407-01, 2063407-02, 2063407-03, 2063407-04, 2063407-05... (Other models you can see in the webshop)		
<b>spare parts for</b>	106018		
		<b>Part No.</b>	101054 <b>Ref. No.</b> —
	magnet unit T1: M10x1 T2: M24x1 L 45mm ø 17mm suitable for Minisit		
		<b>Part No.</b>	101136 <b>Ref. No.</b> 201535
	piezoelectric igniter suitable for Minisit with cover cap ømm connection F6.3x0.8		
<b>accessories for</b>	106018		
		<b>Part No.</b>	101273 <b>Ref. No.</b> 201594
	olive for pipe ø 12mm L 9.5mm brass Qty 1 pcs suitable for universal		
		<b>Part No.</b>	101274 <b>Ref. No.</b> —
	olive for pipe ø 16mm Qty 1 pcs		
		<b>Part No.</b>	101275 <b>Ref. No.</b> —
	union screw thread 1/2" for pipe ø 16mm Qty 1 pcs		
		<b>Part No.</b>	101276 <b>Ref. No.</b> —
	union screw thread 3/8" tube ø 12mm Qty 1 pcs		
		<b>Part No.</b>	101278 <b>Ref. No.</b> —
	olive for pipe ø 10mm Qty 1 pcs		
		<b>Part No.</b>	101279 <b>Ref. No.</b> —
	union screw thread 3/8" for pipe ø 10mm Qty 1 pcs		

MERTIK

			
<b>Part No.</b>	107514	<b>Ref. No.</b>	201799
<b>description</b>	gas thermostat MERTIK t.max. 340°C 100-340°C gas inlet bottom 3/8" gas inlet lateral 3/8" gas outlet bottom 3/8" gas outlet lateral 3/8" thermocouple connection M8x1 pilot connection M10x1 capillary pipe 720mm probe ø 4mm probe L 68mm cable lengthmm gland nut		
<b>For models:</b>	1261101-02, 1261102-02, 1361101-03, 1361102-03, 1461101-03, 1461102-03, 1461104-03, 1461105-03, 1461109-02, 1461109A02, 1561110-00, 2061101-03, 2061101-04, 2061101-05, 2061102-03, 2061102-04, 2061102-05, 2061103-04, 2061107-02, 2061107A02, 2161101-03, 2161102-03, 3061107-02, 3061107A02		
<b>spare parts for</b>	107514		
		<b>Part No.</b>	106221 <b>Ref. No.</b> —
	magnet unit L 32mm D1 ø 19mm D2 ø 14mm suitable for MERTIK		

MP\_JUNKERS







			
<b>Part No.</b>	106024	<b>Ref. No.</b>	201557
<b>description</b>	gas thermostat type 7743-633-402 t.max. 300°C 170-300°C gas inlet 3/8" straight gas outlet 3/8" straight thermocouple connection M10x1 probe ø 6mm probe L 100mm capillary pipe 820mm pressure regulatormbar MP-Junkers pilot connection M8x1 pressure controller no		
<b>For models:</b>	1462101-00, 14621011-0, 1462102-00_V2, 2063404-00, 2063407-00, 2063503-00, 2063505-00, 2163404-00, 2163407-00		
<b>spare parts for</b>	106024		
		<b>Part No.</b>	100111 <b>Ref. No.</b> —
	piezoelectric igniter body plastic blowing mounting ø 22mm connection F6.3x0.8 cable lengthmm		
		<b>Part No.</b>	100115 <b>Ref. No.</b> —
	union nut ID ø M22x1mm		
		<b>Part No.</b>	101060 <b>Ref. No.</b> 201527 201531
	magnet unit standard L 39mm D1 ø 15.4mm D2 ø 11mm suitable for PEL20-21/JUNKERS/EGA		
<b>accessories for</b>	106024		
		<b>Part No.</b>	101273 <b>Ref. No.</b> 201594
	olive for pipe ø 12mm L 9.5mm brass Qty 1 pcs suitable for universal		

Table continues overleaf





accessories for	106024			
	Part No.	101276	Ref. No.	—
	union screw thread 3/8" tube ø 12mm Qty 1 pcs			

## gas valves and ignition boxes

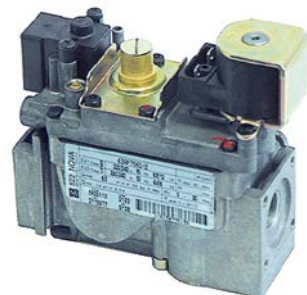
### gas control valves



#### HONEYWELL




1	<b>Part No.</b>	106012	<b>Ref. No.</b>	201181
<b>description</b>	gas valve type VK4115V 220-240V 50/60Hz gas inlet flange 32x32mm gas outlet flange 32x32mm thermocouple connection pilot connection pressure range 15-60mbar max 60mbar operator type HONEYWELL flange 32x32mm			
<b>For models:</b>	CGG11-L, CGG11-R, CGG12-L, CGG12-R, CGG21-L, CGG21-R, CGG22-L, CGG22-R, CGG61-L, CGG61-R, CGG62-L, CGG62-R, CSG11-L, CSG11-R, CSG11-R-DG, CSG12-L, CSG12-R, CSG12-R-DG, CSG21-L, CSG21-R, CSG21-R-DG, CSG22-L, CSG22-R, CSG22-R-DG, CSG61-L, CSG61-R, CSG61-R-DG, CSG62-L, CSG62-R, CSG62-R-DG			
accessories for	106012			
	Part No.	102845	Ref. No.	—
	gas connection angled 1/2" flange 32x32mm hole distance 24x24mm Tandem			
	Part No.	102846	Ref. No.	—
	gas connection straight 1/2" flange 32x32mm hole distance 24x24mm suitable for Tandem			

#### SIT NOVASIT



1	<b>Part No.</b>	101540	<b>Ref. No.</b>	201016
<b>description</b>	gas valve SIT series Novasit 822 230V 50Hz gas inlet 1/2" gas outlet 1/2" thermocouple connection pilot connection closed ignition pressure 3-5mbar pressure range 3-30mbar pressure regulator connection blind equiv. no. 0.822.113			
spare parts for	101540			
	Part No.	101313	Ref. No.	—
	solenoid coil 230V 50Hz			
	Part No.	101542	Ref. No.	—
	solenoid coil 50Hz NOVA 822/826/827 suitable for NOVASIT 230V			

accessories for	101540			
	Part No.	101305	Ref. No.	—
	gas connection straight 1/2" flange 45x45mm ELETTROSIT/V4400/4600/4605 suitable for SIT/HONEYWELL hole distance 36x36mm			
	Part No.	101306	Ref. No.	—
	gas connection angled flange 45x45mm hole distance 36x36mm 1/2" ELETTROSIT/V4400/4600/4605 screw with O-ring suitable for SIT/HONEYWELL			
	Part No.	101307	Ref. No.	—
	gas connection straight flange 45x45mm hole distance 36x36mm 3/4" ELETTROSIT/V4400/4600/4605 screw with O-ring suitable for SIT/HONEYWELL			
	Part No.	101308	Ref. No.	—
	gas connection angled flange 45x45mm hole distance 36x36mm 3/4" ELETTROSIT/V4400/4600/4605 screw with O-ring suitable for SIT/HONEYWELL			
	Part No.	101317	Ref. No.	—
	plug with cable L 1000mm suitable for NOVASIT			
	Part No.	101503	Ref. No.	—
	O-ring EPDM thickness 2mm ID ø 32mm Qty 1 pcs			
	Part No.	101924	Ref. No.	—
	plug with cable L 1090mm suitable for NOVA 822/826/827			

1	<b>Part No.</b>	101914	<b>Ref. No.</b>	201717
<b>description</b>	gas valve SIT series Novasit 822 230V 50Hz gas inlet 1/2" gas outlet 1/2" thermocouple connection pilot connection closed ignition pressure 3-30mbar pressure regulator connection blind equiv. no. 0.822.144			
<b>For models:</b>	2061401-05, 2061401-06, 2061401-07, 2061401-08, 2061401A05, 2061401A06, 2061401A07, 2061401A08, 2061401B05, 2061401B06, 2061401B07, 2061401B08, 2061401C05, 2061401C06, 2061401C07, 2061401C08, 2061402-05, 2061402-06, 2061402-07, 2061402A05, 2061402A06, 2061402A07, 2061402B05, 2061402B06, 2061402B07, 2061402C05, 2061402C06, 2061402C07, 2062801-06, 2062801A06, 2062801B06, 2062801C06, 2062802-06, 2062802A06, 2062802B06, 2062802C06, 2062803-06, 2062803A06, 2062803B06, 2062803C06, 2062804-06, 2062804A06, 2062804B06, 2062804C06, 2161401-03, 2161401-04, 2161401-05, 2161401-06, 2161401A03, 2161401A04... (Other models you can see in the webshop)			
spare parts for	101914			
	Part No.	101313	Ref. No.	—
	solenoid coil 230V 50Hz			
	Part No.	101542	Ref. No.	—
	solenoid coil 50Hz NOVA 822/826/827 suitable for NOVASIT 230V			
accessories for	101914			
	Part No.	101305	Ref. No.	—
	gas connection straight 1/2" flange 45x45mm ELETTROSIT/V4400/4600/4605 suitable for SIT/HONEYWELL hole distance 36x36mm			

Table continues overleaf





accessories for		101914	
Part No.	101306	Ref. No.	—
	gas connection angled flange 45x45mm hole distance 36x36mm 1/2" ELETROSIT/V4400/4600/4605 screw with O-ring suitable for SIT/HONEYWELL		
	gas connection straight flange 45x45mm hole distance 36x36mm 3/4" ELETROSIT/V4400/4600/4605 screw with O-ring suitable for SIT/HONEYWELL		
	gas connection angled flange 45x45mm hole distance 36x36mm 3/4" ELETROSIT/V4400/4600/4605 screw with O-ring suitable for SIT/HONEYWELL		
	O-ring EPDM thickness 2mm ID ø 32mm Qty 1 pcs		
	plug with cable L 1090mm suitable for NOVA 822/826/827		

accessories for		101984	
Part No.	102847	Ref. No.	—
	O-ring		

## ignition boxes

### DUNGS



Part No.	102378	Ref. No.	201643 201662 201699 201735
<b>description</b>	ignition box type DGAI.73 model 10.1.0TCL electrodes 2 starting time <10s waiting time >3s safety time <1s 230V 50/60Hz ignition cable male faston 2.8mm DUNGS protection IP20 DGAI.73		
<b>For models:</b>	1462802B00, 1462802B01, 1462802B02, 1462802B03, 1462802B04, 1462802B05, 1462804B00, 1462804B01, 1462804B02, 1462804B03, 1462804B04, 1462804B05, 2061401-05, 2061401-06, 2061401-07, 2061401-08, 2061401A05, 2061401A06, 2061401A07, 2061401A08, 2061401B05, 2061401B06, 2061401B07, 2061401B08, 2061401C05, 2061401C06, 2061401C07, 2061401C08, 2061402-05, 2061402-06, 2061402-07, 2061402A05, 2061402A06, 2061402A07, 2061402B05, 2061402B06, 2061402B07, 2061402C05, 2061402C06, 2061402C07, 2061403-00, 2061403-02, 2061403-03, 2061403-04, 2061403-05, 20614033-0, 2061403A02, 2061403A03, 2061403A04, 2061403A05... (Other models you can see in the webshop)		

### TANDEM



Part No.	101984	Ref. No.	201718
<b>description</b>	gas valve 230V 50Hz gas inlet 1/2" gas outlet 1/2" pilot connection level slow ignition ignition times pressure range 2-50mbar power supply for modulator 230VAC rectified Tandem equiv. no. 0.836.010		
<b>For models:</b>	1462802B00, 1462802B01, 1462802B02, 1462802B03, 1462802B04, 1462802B05, 1462804B00, 1462804B01, 1462804B02, 1462804B03, 1462804B04, 1462804B05, 2061403-02, 2061403-03, 2061403-04, 2061403-05, 2061403A02, 2061403A03, 2061403A04, 2061403A05, 2061403B02, 2061403B03, 2061403B04, 2061403B05, 2061403C02, 2061403C03, 2061403C04, 2061403C05, 2061404-02, 2061404-03, 2061404-04, 2061404-05, 2061404A02, 2061404A03, 2061404A04, 2061404A05, 2061404B02, 2061404B03, 2061404B04, 2061404B05, 2061404C02, 2061404C03, 2061404C04, 2061404C05, 2061405-01, 2061405-02, 2061405-03, 2061405-04, 2061405B01, 2061405B02... (Other models you can see in the webshop)		
<b>spare parts for</b>	101984		
	Part No. 101379	Ref. No.	—
solenoid coil 230V 50Hz suitable for Tandem			
<b>accessories for</b>	101984		
	Part No. 101274	Ref. No.	—
olive for pipe ø 16mm Qty 1 pcs			
	Part No. 101275	Ref. No.	—
union screw thread 1/2" for pipe ø 16mm Qty 1 pcs			
	Part No. 101925	Ref. No.	—
plug with O-ring thread M10x1 for pilot burner suitable for NOVASIT			
	Part No. 102845	Ref. No.	—
gas connection angled 1/2" flange 32x32mm hole distance 24x24mm Tandem			
	Part No. 102846	Ref. No.	—
gas connection straight 1/2" flange 32x32mm hole distance 24x24mm suitable for Tandem			

### HONEYWELL



Part No.	106607	Ref. No.	201180
<b>description</b>	cover for ignition box		
<b>For models:</b>	CGG11-L, CGG11-R, CGG12-L, CGG12-R, CGG21-L, CGG21-R, CGG22-L, CGG22-R, CGG61-L, CGG61-R, CGG62-L, CGG62-R, CSG11-L, CSG11-R, CSG11-R-DG, CSG12-L, CSG12-R, CSG12-R-DG, CSG21-L, CSG21-R, CSG21-R-DG, CSG22-L, CSG22-R, CSG22-R-DG, CSG61-L, CSG61-R, CSG61-R-DG, CSG62-L, CSG62-R, CSG62-R-DG		



Honeywell



1

<b>Part No.</b>	106606	<b>Ref. No.</b>	201179
<b>description</b>	ignition box HONEYWELL type S4575B 1025 electrodes 3 waiting times safety time 5s 230-240V 4VA 50/60Hz		
<b>For models:</b>	CGG11-L, CGG11-R, CGG12-L, CGG12-R, CGG21-L, CGG21-R, CGG22-L, CGG22-R, CGG61-L, CGG61-R, CGG62-L, CGG62-R, CSG11-L, CSG11-R, CSG11-R-DG, CSG12-L, CSG12-R, CSG12-R-DG, CSG21-L, CSG21-R, CSG21-R-DG, CSG22-L, CSG22-R, CSG22-R-DG, CSG61-L, CSG61-R, CSG61-R-DG, CSG62-L, CSG62-R, CSG62-R-DG		

## gas solenoid valves

DUNGS



1

<b>Part No.</b>	102379 <sup>1</sup>	<b>Ref. No.</b>	201529
<b>description</b>	solenoid valve 230VAC connection 1/2" L 76mm DUNGS p max 0.2bar p min 0bar reg. no. 63AQ0626 gas inlet 1/2" gas outlet 1/2"		
<b>For models:</b>	2061403-00, 2061403-01, 20614033-0, 2061403A00, 2061403B00, 2061403C00, 2061404-00, 2061404-01, 20614044-0, 2061404A00, 2061404B00, 2061404C00, 2061405-00, 2061405B00, 2061406-00, 2061406B00, 20628033-0, 20628044-0, 20629011-0, 20629022-0, 3061403-00, 3061403A00, 3061403B00, 3061403C00, 3061404-00, 3061404A00, 3061404B00, 3061404C00, 3061405-00, 3061405B00, 3061405B01, 3061406-00, 3061406B00		

<sup>1</sup>aluminium housing

## ignition parts

## pilot burners

JUNKERS

CB 502 series

pilot burners



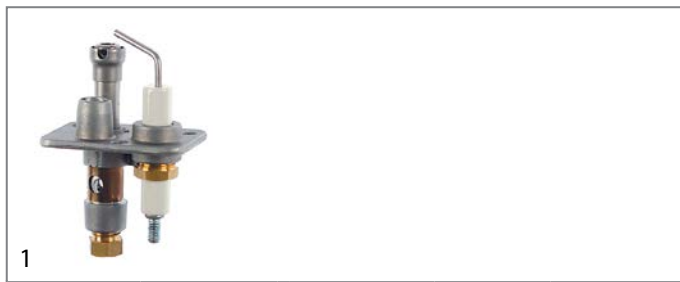
1

<b>Part No.</b>	100085	<b>Ref. No.</b>	201598	
<b>description</b>	pilot burner JUNKERS type CB502031 natural gas nozzle no.6 gas connection 6mm with primary air			
<b>For models:</b>	0260301-00, 0260301-01, 0260302-00, 0260302-01, 0260501-00, 0261101-00, 0261101-01, 0261102-00, 0261102-01, 0261103-00, 0261103-01, 0261301-00, 0261601-00, 1461101-00, 1461102-00, 1461103-00, 1462101-00, 1462101-01, 1462101-02, 14621011-0, 1462102-00, 1462102-00_V2, 1462102-01, 2060301-00, 2061101-00, 20611011-0, 2061102-00, 20611022-0, 2061103-00, 20611033-0, 2061104-00, 20611044-0, 2061105-00, 20611055-0, 2061106-00, 20611066-0, 2061401-02, 2061401-03, 2061401-04, 2061401A01, 2061401A02, 2061401A03, 2061401B01, 2061401B02, 2061401B03, 2061401C01, 2061401C02, 2061401C03, 2061402-02, 2061402-03... (Other models you can see in the webshop)			
<b>spare parts for</b>	100085			
	<b>Part No.</b>	100227	<b>Ref. No.</b>	—
	pilot burner nozzle natural gas gas pressure 25mbar code 6 Qty 1 pcs suitable for JUNKERS CB50203_			
	<b>Part No.</b>	100704	<b>Ref. No.</b>	201570 201572 201578
	ignition electrode D1 ø 9mm connection M4 D2 ø 11mm L1 17mm L2 17mm BL1 13mm BL2 4mm BL3 22mm			
	<b>Part No.</b>	100909	<b>Ref. No.</b>	—
	union screw thread M10x1 for pipe ø 6mm Qty 1 pcs			
	<b>Part No.</b>	101287	<b>Ref. No.</b>	—
	olive for pipe ø 6mm Qty 1 pcs			
	<b>Part No.</b>	101292	<b>Ref. No.</b>	—
	union screw for igniter suitable for CB 502/505 Qty 1 pcs			
	<b>Part No.</b>	101295	<b>Ref. No.</b>	—
	clamping collet for thermocouple suitable for CB 502/505 Qty 1 pcs			
<b>accessories for</b>	100085			
	<b>Part No.</b>	100220	<b>Ref. No.</b>	201547
	pilot burner nozzle LPG gas pressure 50mbar code 2 Qty 1 pcs suitable for JUNKERS CB503_			
	<b>Part No.</b>	100221	<b>Ref. No.</b>	—
	pilot burner nozzle LPG gas pressure 30mbar code 29 Qty 1 pcs suitable for JUNKERS CB50203_			
	<b>Part No.</b>	100222	<b>Ref. No.</b>	201641
	pilot burner nozzle LPG gas pressure 50mbar code 5 Qty 1 pcs suitable for JUNKERS CB50203_			
	<b>Part No.</b>	100223	<b>Ref. No.</b>	—
	pilot burner nozzle natural gas gas pressure 20mbar code 3 Qty 1 pcs suitable for JUNKERS CB503_			






Table continues overleaf













accessories for		100085		
Part No.		100224	Ref. No.	—
	pilot burner nozzle natural gas gas pressure 25mbar code 26 Qty 1 pcs suitable for JUNKERS CB503_			
	pilot burner nozzle LPG gas pressure 30mbar code 39 Qty 1 pcs suitable for JUNKERS CB503_			
	pilot burner nozzle LPG gas pressure 50mbar code 15 suitable for JUNKERS			
	pilot burner nozzle town gas gas pressure 8mbar code 4 Qty 1 pcs suitable for JUNKERS CB50203_			
	olive for pipe ø 4mm L 8.7mm Qty 1 pcs suitable for CB 502/503			201560
	union screw thread M10x1 for pipe ø 4mm Qty 1 pcs			201692



Part No.	102843	Ref. No.	520917 520997
description	pilot burner JUNKERS type CB502031 natural gas nozzle no.6 gas pressure 25mbar gas connection 6mm with primary air		
For models:	0261101-01, 0261102-01, 0261103-01, 2060301-00, 2061104-00, 2061105-00, 2061106-00, 2062801-00, 2062801A00, 2062801B00, 2062801C00, 2062802-00, 2062802-0, 20628022-1, 20628022-2, 2062802A00, 2062802B00, 2062802C00, 2062803-00, 20628033-0, 20628033-2, 2062803A00, 2062803B00, 2062803C00, 2062804-00, 20628044-0, 20628044-2, 2062804A00, 2062804B00, 2062804C00, 2062901-00, 20629011-0, 20629011-2, 2062901A00, 2062901B00, 2062901B01, 2062901B02, 2062901C00, 2062901C01, 2062901C02, 2062902-00, 20629022-0, 20629022-2, 2062902A00, 2062902B00, 2062902B01, 2062902B02, 2062902C00, 2062902C01, 2062902C02		

spare parts for		102843		
Part No.		100227	Ref. No.	—
	pilot burner nozzle natural gas gas pressure 25mbar code 6 Qty 1 pcs suitable for JUNKERS CB50203_			
	ignition electrode D1 ø 9mm connection M4 D2 ø 11mm L1 17mm L2 17mm BL1 13mm BL2 4mm BL3 22mm			201570 201572 201578
	union screw thread M10x1 for pipe ø 6mm Qty 1 pcs			—
	olive for pipe ø 6mm Qty 1 pcs			—
	union screw for igniter suitable for CB 502/505 Qty 1 pcs			—




accessories for		102843		
Part No.		100220	Ref. No.	201547
	pilot burner nozzle LPG gas pressure 50mbar code 2 Qty 1 pcs suitable for JUNKERS CB503_			

accessories for		102843		
Part No.		100221	Ref. No.	—
	pilot burner nozzle LPG gas pressure 30mbar code 29 Qty 1 pcs suitable for JUNKERS CB50203_			
	pilot burner nozzle LPG gas pressure 50mbar code 5 Qty 1 pcs suitable for JUNKERS CB50203_			201641
	pilot burner nozzle natural gas gas pressure 20mbar code 3 Qty 1 pcs suitable for JUNKERS CB503_			—
	pilot burner nozzle natural gas gas pressure 25mbar code 26 Qty 1 pcs suitable for JUNKERS CB503_			—
	pilot burner nozzle LPG gas pressure 30mbar code 39 Qty 1 pcs suitable for JUNKERS CB503_			—
	pilot burner nozzle LPG gas pressure 50mbar code 15 suitable for JUNKERS			—
	pilot burner nozzle town gas gas pressure 8mbar code 4 Qty 1 pcs suitable for JUNKERS CB50203_			—
	olive for pipe ø 4mm L 8.7mm Qty 1 pcs suitable for CB 502/503			201560
	union screw thread M10x1 for pipe ø 4mm Qty 1 pcs			201692

CB 503 series

pilot burners



Part No.	100121	Ref. No.	201544
description	pilot burner JUNKERS type CB503002 natural gas gas pressure 15mbar		
spare parts for	100121		
	pilot burner nozzle natural gas gas pressure 20mbar code 3 Qty 1 pcs suitable for JUNKERS CB503_		—
	olive for pipe ø 4mm L 8.7mm Qty 1 pcs suitable for CB 502/503		201560
	union screw thread M10x1 for pipe ø 4mm Qty 1 pcs		201692










accessories for		100121		
Part No.		100220	Ref. No.	201547
	pilot burner nozzle LPG gas pressure 50mbar code 2 Qty 1 pcs suitable for JUNKERS CB503_			
	pilot burner nozzle LPG gas pressure 30mbar code 29 Qty 1 pcs suitable for JUNKERS CB50203_			—

Table continues overleaf



accessories for		100121		
	Part No.	100222	Ref. No.	201641
	pilot burner nozzle LPG gas pressure 50mbar code 5 Qty 1 pcs suitable for JUNKERS CB50203_			
	Part No.	100224	Ref. No.	—
	pilot burner nozzle natural gas gas pressure 25mbar code 26 Qty 1 pcs suitable for JUNKERS CB503_			
	Part No.	100226	Ref. No.	—
	pilot burner nozzle LPG gas pressure 50mbar code 15 suitable for JUNKERS			
	Part No.	100227	Ref. No.	—
	pilot burner nozzle natural gas gas pressure 25mbar code 6 Qty 1 pcs suitable for JUNKERS CB50203_			
	Part No.	100228	Ref. No.	—
	pilot burner nozzle town gas gas pressure 8mbar code 4 Qty 1 pcs suitable for JUNKERS CB50203_			
	Part No.	100909	Ref. No.	—
	union screw thread M10x1 for pipe ø 6mm Qty 1 pcs			
	Part No.	101287	Ref. No.	—
	olive for pipe ø 6mm Qty 1 pcs			

				
1				
<b>Part No.</b>	100058	<b>Ref. No.</b>	201544	
<b>description</b>	pilot burner JUNKERS type CB503006 natural gas nozzle no.26 gas connection 4mm			
<b>spare parts for</b>	100058			
	Part No.	100224	Ref. No.	—
	pilot burner nozzle natural gas gas pressure 25mbar code 26 Qty 1 pcs suitable for JUNKERS CB503_			
	Part No.	101281	Ref. No.	201560
	olive for pipe ø 4mm L 8.7mm Qty 1 pcs suitable for CB 502/503			
	Part No.	101283	Ref. No.	201692
	union screw thread M10x1 for pipe ø 4mm Qty 1 pcs			
<b>accessories for</b>	100058			
	Part No.	100220	Ref. No.	201547
	pilot burner nozzle LPG gas pressure 50mbar code 2 Qty 1 pcs suitable for JUNKERS CB503_			
	Part No.	100221	Ref. No.	—
	pilot burner nozzle LPG gas pressure 30mbar code 29 Qty 1 pcs suitable for JUNKERS CB50203_			
	Part No.	100222	Ref. No.	201641
	pilot burner nozzle LPG gas pressure 50mbar code 5 Qty 1 pcs suitable for JUNKERS CB50203_			
	Part No.	100223	Ref. No.	—
	pilot burner nozzle natural gas gas pressure 20mbar code 3 Qty 1 pcs suitable for JUNKERS CB503_			
	Part No.	100226	Ref. No.	—
	pilot burner nozzle LPG gas pressure 50mbar code 15 suitable for JUNKERS			
	Part No.	100227	Ref. No.	—
	pilot burner nozzle natural gas gas pressure 25mbar code 6 Qty 1 pcs suitable for JUNKERS CB50203_			

accessories for		100058		
	Part No.	100228	Ref. No.	—
	pilot burner nozzle town gas gas pressure 8mbar code 4 Qty 1 pcs suitable for JUNKERS CB50203_			
	Part No.	100909	Ref. No.	—
	union screw thread M10x1 for pipe ø 6mm Qty 1 pcs			
	Part No.	101287	Ref. No.	—
	olive for pipe ø 6mm Qty 1 pcs			
	Part No.	102110	Ref. No.	—
	pilot tube copper pipe ø 4mm thickness 1mm L 3000mm			
	Part No.	102111	Ref. No.	—
	pilot tube copper pipe ø 6mm thickness 1mm L 3000mm			

## producer-specific pilot burners

## MKN

## EA\_ , HL\_ , SL\_ , Optima700 series









				
1				
<b>Part No.</b>	102841	<b>Ref. No.</b>	201681	
<b>description</b>	pilot burner SIT type 160 series 2 flames natural gas nozzle ø 0.41mm gas connection 4mm nozzle no.41			
<b>For models:</b>	1260301-00, 1260301-01, 1260302-00, 1260302-01, 1261301-00, 1261301-01, 1261301-02, 1261601-00, 1261601-01, 1361301-00, 1361301-01, 1361301-02, 1361301-03, 1361601-00, 1361601-01, 1361601-02, 1460302-01, 1460302-02, 1461601-00, 2060301-01, 2060301-02, 2061301-01			
<b>spare parts for</b>	102841			
	Part No.	100202	Ref. No.	—
	pilot burner nozzle natural gas code 41 Qty 1 pcs nozzle ø 0.41mm			
	Part No.	100701	Ref. No.	201690 201691
	ignition electrode connection M4 Qty 1 pcs			
	Part No.	100906	Ref. No.	201693
	screw connection thread M10x1 for ignition electrode brass Qty 1 pcs WS 10			
	Part No.	100907	Ref. No.	—
	screw connection thread M10x1 Qty 1 pcs type SEF 1 ømm for thermocouple			
	Part No.	100908	Ref. No.	—
	union screw thread M10x1 for pipe ø 4mm Qty 1 pcs			
	Part No.	101282	Ref. No.	—
	olive for pipe ø 4mm L 7.4mm Qty 1 pcs			
<b>accessories for</b>	102841			
	Part No.	100203	Ref. No.	—
	pilot burner nozzle LPG code 25 Qty 1 pcs nozzle ø 0.25mm			

Table continues overleaf
















accessories for		102841	
Part No.	100869	Ref. No.	—
	pilot burner nozzle natural gas code 51 Qty 1 pcs suitable for 160 series nozzle ø 0.51mm		
Part No.	100909	Ref. No.	—
	union screw thread M10x1 for pipe ø 6mm Qty 1 pcs		
Part No.	101287	Ref. No.	—
	olive for pipe ø 6mm Qty 1 pcs		
Part No.	107650	Ref. No.	—
	pilot burner nozzle SIT LPG code 30 Qty 1 pcs		



Part No.	102840	Ref. No.	201680
<b>description</b>	pilot burner SIT type 160 series 2 flames nozzle ø 0.41mm gas connection 6mm with igniter		
<b>For models:</b>	1260501-00, 1261101-00, 1261101-01, 1261101-02, 1261102-00, 1261102-01, 1261102-02, 1261602-00, 1261602-01, 1261602-02, 1261602-03, 1261604-03, 1360501-00, 1360501-01, 1361101-00, 1361101-01, 1361101-02, 1361101-03, 1361102-00, 1361102-01, 1361102-02, 1361102-03, 1361602-00, 1361602-01, 1361602-02, 1361604-02, 1460503-01, 1461101-01, 1461101-02, 1461101-03, 1461102-01, 1461102-02, 1461102-03, 1461104-01, 1461104-02, 1461104-03, 1461105-01, 1461105-02, 1461105-03, 1461109-01, 1461109-02, 1461109A01, 1461109A02, 1461602-00, 1462101-03, 1462101-04, 1462102-02, 1462102-03, 1561110-00, 2061101-01... (Other models you can see in the webshop)		

spare parts for		102840	
Part No.	100202	Ref. No.	—
	pilot burner nozzle natural gas code 41 Qty 1 pcs nozzle ø 0.41mm		
Part No.	100701	Ref. No.	201690 201691
	ignition electrode connection M4 Qty 1 pcs		
Part No.	100906	Ref. No.	201693
	screw connection thread M10x1 for ignition electrode brass Qty 1 pcs WS 10		
Part No.	100907	Ref. No.	—
	screw connection thread M10x1 Qty 1 pcs type SEF 1 ømm for thermocouple		
Part No.	100909	Ref. No.	—
	union screw thread M10x1 for pipe ø 6mm Qty 1 pcs		
Part No.	101287	Ref. No.	—
	olive for pipe ø 6mm Qty 1 pcs		



accessories for		102840	
Part No.	100203	Ref. No.	—
	pilot burner nozzle LPG code 25 Qty 1 pcs nozzle ø 0.25mm		
Part No.	100869	Ref. No.	—
	pilot burner nozzle natural gas code 51 Qty 1 pcs suitable for 160 series nozzle ø 0.51mm		






accessories for		102840	
Part No.	100908	Ref. No.	—
	union screw thread M10x1 for pipe ø 4mm Qty 1 pcs		
Part No.	101282	Ref. No.	—
	olive for pipe ø 4mm L 7.4mm Qty 1 pcs		
Part No.	107650	Ref. No.	—
	pilot burner nozzle SIT LPG code 30 Qty 1 pcs		

Universal series





Part No.	100088	Ref. No.	201820
<b>description</b>	pilot burner EGA type B		
<b>For models:</b>	0263401-00, 0263401-01, 1263401-00, 1263402-00, 1263402-01, 1263402-02, 1263404-00, 1263404-01, 1263404-02, 1263405-00, 1263405-01, 1263413-02, 1263414-02, 1363401-00, 1363402-00, 1363402-01, 1363402-02, 1363403-00, 1363403-01, 1363403-02, 1363403-03, 1363403-04, 1363403-05, 1363404-00, 1363404-01, 1363404-02, 1363404-03, 1363405-00, 1363405-01, 1363413-03, 1363415-05, 1464802-01, 1464802-02, 1464803-01, 1464803-02, 1464803-03, 1464808-01, 1464808-02, 1464808-03, 1464809-01, 1464809-02, 1464809-03, 1464810-01, 1464810-02, 1464811-01, 1464811-02, 1464812-00, 1464812-01, 1464812-02, 2063401-00... (Other models you can see in the webshop)		

spare parts for		100088	
Part No.	100961	Ref. No.	201819
	pilot burner head thread M7x0.75mm thread L 5mm ED ø 6mm ID ø 4.4mm total length 30mm L 20mm WS 8		
Part No.	101345	Ref. No.	—
	nut thread M15x1 H 3mm WS 19 brass Qty 1 pcs		

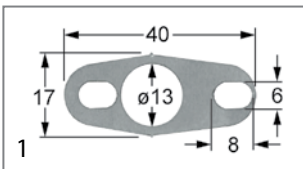
accessories for		100088	
Part No.	100270	Ref. No.	201821
	pilot burner nozzle LPG bore ø 0.2mm thread M8x0.75 T1: M8x1		
Part No.	100271	Ref. No.	201822
	pilot burner nozzle natural gas bore ø 0.3mm		
Part No.	100960	Ref. No.	201040 575286
	cover for pilot burner		
Part No.	101259	Ref. No.	—
	union nut thread M8x1 for pipe ø 4mm		
Part No.	101284	Ref. No.	201827
	olive for pipe ø 4mm Qty 1 pcs		



<b>Part No.</b>	103183	<b>Ref. No.</b>	N/A
<b>description</b>	pilot burner EGA type B		
<b>spare parts for</b>	103183		
	<b>Part No.</b>	100960	<b>Ref. No.</b> 201040 575286
cover for pilot burner			

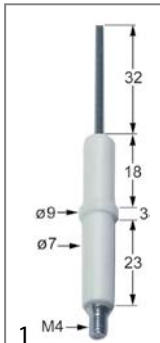
electrodes




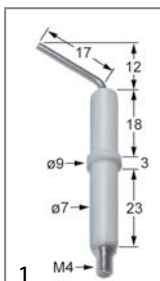
<b>Part No.</b>	107886	<b>Ref. No.</b>	911589
<b>description</b>	bracket for glow electrode plate L 40mm W 17mm bore $\phi$ 13mm		
<b>For models:</b>	CGG11-L, CGG11-R, CGG12-L, CGG12-R, CGG21-L, CGG21-R, CGG22-L, CGG22-R, CGG61-L, CGG61-R, CGG62-L, CGG62-R, CSG11-L, CSG11-R, CSG11-R-DG, CSG12-L, CSG12-R, CSG12-R-DG, CSG21-L, CSG21-R, CSG21-R-DG, CSG22-L, CSG22-R, CSG22-R-DG, CSG61-L, CSG61-R, CSG61-R-DG, CSG62-L, CSG62-R, CSG62-R-DG		



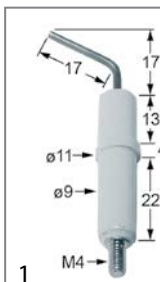
<b>Part No.</b>	102289	<b>Ref. No.</b>	201176 201176+ 211137+ 2x211143
<b>description</b>	glow plug mounting distance 28mm cable length 600mm connection male faston 2.8mm		
<b>For models:</b>	CGG11-L, CGG11-R, CGG12-L, CGG12-R, CGG21-L, CGG21-R, CGG22-L, CGG22-R, CGG61-L, CGG61-R, CGG62-L, CGG62-R, CSG11-L, CSG11-R, CSG11-R-DG, CSG12-L, CSG12-R, CSG12-R-DG, CSG21-L, CSG21-R, CSG21-R-DG, CSG22-L, CSG22-R, CSG22-R-DG, CSG61-L, CSG61-R, CSG61-R-DG, CSG62-L, CSG62-R, CSG62-R-DG		
<b>spare parts for</b>	102289		
	<b>Part No.</b>	691609	<b>Ref. No.</b> 211143
gasket graphite ED $\phi$ 150mm ID $\phi$ 115mm thickness 2mm Qty 1 pcs			



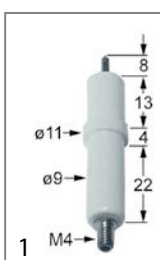
<b>Part No.</b>	100701	<b>Ref. No.</b>	201690 201691
<b>description</b>	ignition electrode connection M4 Qty 1 pcs		
<b>accessories for</b>	100701		
	<b>Part No.</b>	100906	<b>Ref. No.</b> 201693
screw connection thread M10x1 for ignition electrode brass Qty 1 pcs WS 10			



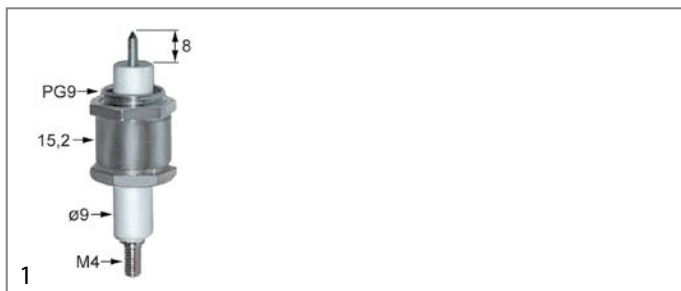
<b>Part No.</b>	100719	<b>Ref. No.</b>	201577
<b>description</b>	ignition electrode D1 $\phi$ 7mm D2 $\phi$ 9mm connection M4 L1 12mm L2 17mm BL1 18mm BL2 3mm BL3 23mm		
<b>For models:</b>	2061403-00, 20614033-0		



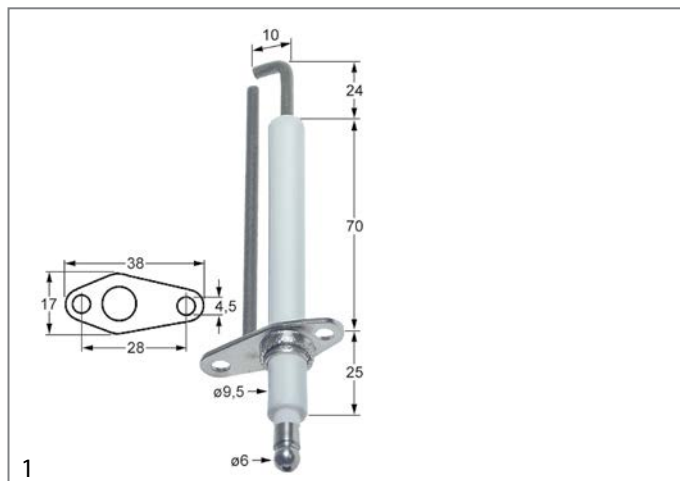
<b>Part No.</b>	100704	<b>Ref. No.</b>	201570 201572 201578
<b>description</b>	ignition electrode D1 $\phi$ 9mm connection M4 D2 $\phi$ 11mm L1 17mm L2 17mm BL1 13mm BL2 4mm BL3 22mm		



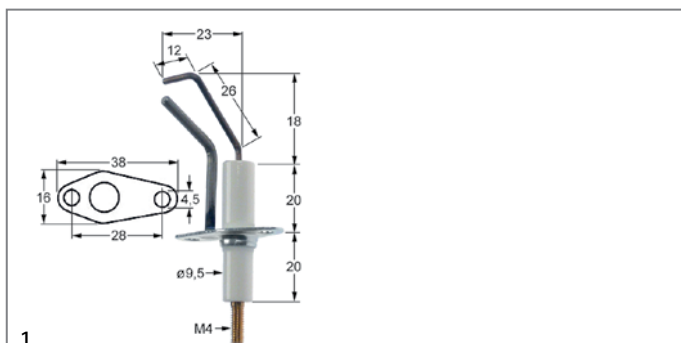
<b>Part No.</b>	100703	<b>Ref. No.</b>	636700
<b>description</b>	ignition electrode D1 $\phi$ 9mm connection M4 D2 $\phi$ 11mm L1 8mm BL1 13mm BL2 4mm BL3 22mm to clip		



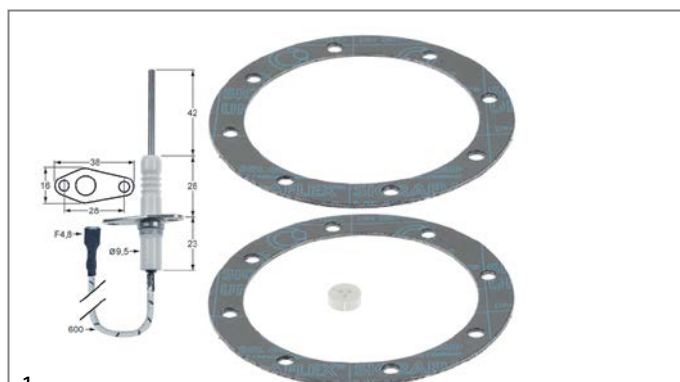
<b>Part No.</b>	100741	<b>Ref. No.</b>	201597
<b>description</b>	ignition electrode D1 ø9mm L1 8mm connection M4 PG9		
<b>For models:</b>	14621011-0, 1463501-00, 1463501-01, 2060501-00, 2060501-01, 20605011-0, 2061401-00, 2061401-01, 2061401A00, 2061401B00, 2061401C00, 2061402-00, 2061402-01, 2061402A00, 2061402B00, 2061402C00, 2063501-00, 2063501-01, 20635011-0, 2063502-00, 2063502-01, 2063502-02, 20635022-0, 2063503-00, 2063503-01, 20635033-0, 2063504-00, 2063504-01, 20635044-0, 2063505-00, 20635055-0, 2063506-00, 2063506-01, 20635066-0, 2063507-00, 2063507-01, 2063507-02, 20635077-0, 2063508-00, 2063508-01, 20635088-0, 2063509-00, 2063509-01, 2063509-02		



<b>Part No.</b>	102268	<b>Ref. No.</b>	201719
<b>description</b>	ignition electrode flange length 38mm flange width 17mm D1 ø 9.5mm L1 24mm L2 10mm BL1 70mm BL2 25mm fixing dimensions ø4.5mm mounting distance 28mm with flange with earthing contact connection ø 6mm		
<b>For models:</b>	1462802B00, 1462802B01, 1462802B02, 1462802B03, 1462802B04, 1462802B05, 1462804B00, 1462804B01, 1462804B02, 1462804B03, 1462804B04, 1462804B05, 2061409B00, 2061409B01, 2061411B00, 2062801-06, 2062801A06, 2062801B06, 2062801C06, 2062802-06, 2062802A06, 2062802B06, 2062802B07, 2062802B08, 2062802B09, 2062802B10, 2062802B11, 2062802B12, 2062802B13, 2062802C06, 2062803-06, 2062803A06, 2062803B06, 2062803C06, 2062804-06, 2062804A06, 2062804B06, 2062804B07, 2062804B08, 2062804B09, 2062804B10, 2062804B11, 2062804B12, 2062804B13, 2062804C06, 2062807B00, 2062807B01, 2062807B02, 2062807B03, 2062808B00... (Other models you can see in the webshop)		



<b>Part No.</b>	102834	<b>Ref. No.</b>	201639
<b>description</b>	ignition electrode flange length 38mm flange width 16mm D1 ø 9.5mm L1 18mm L2 23mm L4 26mm L3 12mm BL1 20mm BL2 20mm connection M4 fixing dimensions ø4.5mm mounting distance 28mm with flange with earthing contact		
<b>For models:</b>	1463501-02, 1463501-03, 1463501-04, 1463501-05, 2061401-05, 2061401-06, 2061401-07, 2061401-08, 2061401A05, 2061401A06, 2061401A07, 2061401A08, 2061401B05, 2061401B06, 2061401B07, 2061401B08, 2061401C05, 2061401C06, 2061401C07, 2061401C08, 2061402-05, 2061402-06, 2061402-07, 2061402A05, 2061402A06, 2061402A07, 2061402B05, 2061402B06, 2061402B07, 2061402C05, 2061402C06, 2061402C07, 2061403-01, 2061403-02, 2061403-03, 2061403-04, 2061403-05, 20614033-0, 2061403A00, 2061403A02, 2061403A03, 2061403A04, 2061403A05, 2061403B00, 2061403B02, 2061403B03, 2061403B04, 2061403B05, 2061403C00, 2061403C02... (Other models you can see in the webshop)		



<b>Part No.</b>	102290	<b>Ref. No.</b>	201177
<b>description</b>	monitoring electrode flange length 38mm D1 ø 9.5mm flange width 16mm L1 42mm BL1 28mm BL2 23mm connection F4.8x0.8 cable length 600mm fixing dimensions 28mm		
<b>For models:</b>	CGG11-L, CGG11-R, CGG12-L, CGG12-R, CGG21-L, CGG21-R, CGG22-L, CGG22-R, CGG61-L, CGG61-R, CGG62-L, CGG62-R, CSG11-L, CSG11-R, CSG11-R-DG, CSG12-L, CSG12-R, CSG12-R-DG, CSG21-L, CSG21-R, CSG21-R-DG, CSG22-L, CSG22-R, CSG22-R-DG, CSG61-L, CSG61-R, CSG61-R-DG, CSG62-L, CSG62-R, CSG62-R-DG		



<b>Part No.</b>	100906	<b>Ref. No.</b>	201693
<b>description</b>	screw connection thread M10x1 for ignition electrode brass Qty 1 pcs WS 10		



## ignition cables

## pre-assembled cables



1

Part No.	102164	Ref. No.	203422
description	ignition cable cable length 1000mm connection F6.3mm / lug M4		
For models:	1260301-00, 1260301-01, 1260302-00, 1260302-01, 1260501-00, 1261101-01, 1261101-02, 1261102-01, 1261102-02, 1261301-00, 1261301-01, 1261301-02, 1261601-01, 1261602-00, 1261602-01, 1261602-02, 1261602-03, 1261604-03, 1360501-00, 1360501-01, 1361101-01, 1361101-02, 1361101-03, 1361102-01, 1361102-02, 1361102-03, 1361301-00, 1361301-01, 1361301-02, 1361301-03, 1361601-01, 1361601-02, 1361602-00, 1361602-01, 1361602-02, 1361604-02, 1460302-01, 1460302-02, 1460503-01, 1461101-02, 1461101-03, 1461102-02, 1461102-03, 1461104-02, 1461104-03, 1461105-02, 1461105-03, 1461109-01, 1461109-02, 1461109A01... (Other models you can see in the webshop)		

## piezoelectric igniters

## mounting diameter 22mm




1

Part No.	105209 <sup>1</sup>	Ref. No.	910736
description	piezoelectric igniter body plastic blowing mounting ø 22mm connection F6.3x0.8 cable length 200mm		
For models:	1260501-00, 1261101-00, 1261101-01, 1261101-02, 1261102-00, 1261102-01, 1261102-02, 1261301-00, 1261301-01, 1261301-02, 1261601-00, 1261601-01, 1261602-00, 1261602-01, 1261602-02, 1261602-03, 1261604-03, 1360501-00, 1360501-01, 1361101-00, 1361101-01, 1361101-02, 1361101-03, 1361102-00, 1361102-01, 1361102-02, 1361102-03, 1361301-00, 1361301-01, 1361301-02, 1361301-03, 1361601-00, 1361601-01, 1361601-02, 1361602-00, 1361602-01, 1361602-02, 1361604-02, 1461101-01, 1461101-02, 1461101-03, 1461102-01, 1461102-02, 1461102-03, 1461104-01, 1461104-02, 1461104-03, 1461105-01, 1461105-02, 1461105-03... (Other models you can see in the webshop)		

<sup>1</sup>cable length 200mm

1

Part No.	100039	Ref. No.	201519 201537	
description	piezoelectric igniter body plastic blowing mounting ø 22mm connection F6.3x0.8 cable lengthmm			
For models:	1260501-00, 1261101-00, 1261101-01, 1261101-02, 1261102-00, 1261102-01, 1261102-02, 1261301-00, 1261301-01, 1261301-02, 1261601-00, 1261601-01, 1261602-00, 1261602-01, 1261602-02, 1261602-03, 1261604-03, 1360501-00, 1360501-01, 1361101-00, 1361101-01, 1361101-02, 1361101-03, 1361102-00, 1361102-01, 1361102-02, 1361102-03, 1361301-00, 1361301-01, 1361301-02, 1361301-03, 1361601-00, 1361601-01, 1361601-02, 1361602-00, 1361602-01, 1361602-02, 1361604-02, 1461101-01, 1461101-02, 1461101-03, 1461102-01, 1461102-02, 1461102-03, 1461104-01, 1461104-02, 1461104-03, 1461105-01, 1461105-02, 1461105-03... (Other models you can see in the webshop)			
accessories for	100039			
	Part No.	100115	Ref. No.	—
	union nut ID ø M22x1mm			

## miscellaneous




1

Part No.	nla <sup>1</sup>	Ref. No.	201536
description	piezoelectric igniter body metal connection F6.3x0.8 2 hole fixing ø 22mm		
For models:	0260501-00, 0261101-00, 0261101-01, 0261102-00, 0261102-01, 0261103-00, 0261103-01, 0261301-00, 0261601-00, 0261401-00, 0261401-01, 0261401A00, 0261401B00, 0261401C00, 0261402-00, 0261402-01, 0261402A00, 0261402B00, 0261402C00		

<sup>1</sup>no longer available

1

Part No.	nla <sup>1</sup>	Ref. No.	201535	
description	piezoelectric igniter suitable for Minisit with cover cap ømm connection F6.3x0.8			
spare parts for	101136			
	Part No.	100001	Ref. No.	—
	piezoelectric igniter suitable for Minisit connection F6.3x0.8 ømm			

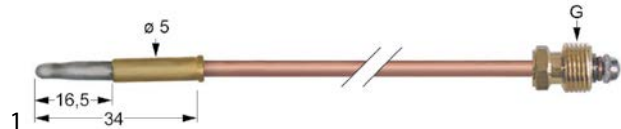
<sup>1</sup>no longer available

## thermocouples

## plug-in thermocouples

## plug-in thermocouples standard

## with barrel socket ø5mm - type Junkers with aluminised tip



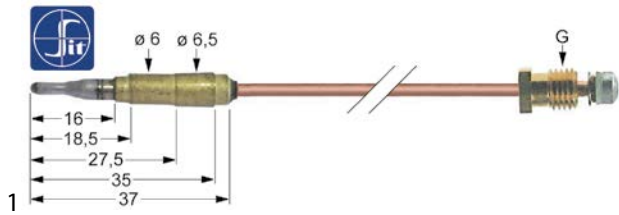
1

Part No.	102132	Ref. No.	201513
description	thermocouple M10x1 L 1000mm plug connection ø5.0mm		
For models:	0260301-01, 0260302-01, 1461101-00, 1461102-00, 1461103-00, 1462101-00, 1462101-01, 1462101-02, 1462101-0, 1462102-00, 1462102-00_V2, 1462102-01, 2061101-00, 2061102-00, 2061103-00, 2061401-02, 2061401-03, 2061401-04, 2061401A01, 2061401A02, 2061401A03, 2061401B01, 2061401B02, 2061401B03, 2061401C01, 2061401C02, 2061401C03, 2061402-02, 2061402-03, 2061402-04, 2061402A01, 2061402A02, 2061402A03, 2061402B01, 2061402B02, 2061402B03, 2061402C01, 2061402C02, 2061402C03, 2062806-00, 2062806A00, 2062806B00, 2062806B01, 2062806B02, 2062806B03, 2062806C00, 2062806C01, 2062806C02, 2062806C03, 2063404-00... (Other models you can see in the webshop)		



with barrel socket ø6mm

SIT



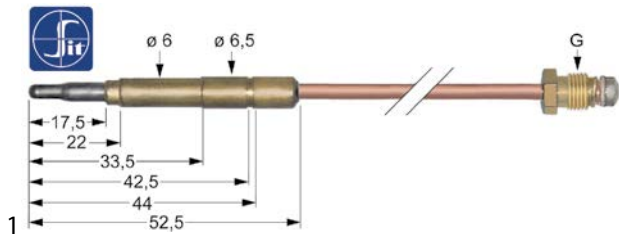
**Part No.** 102267 **Ref. No.** 201670

**description** thermocouple M8x1 L 850mm plug connection ø6.0mm

**For models:** 1260501-00, 1261101-00, 1261101-01, 1261101-02, 1261102-00, 1261102-01, 1261102-02, 1261602-00, 1261602-01, 1261602-02, 1261602-03, 1261604-03, 1360501-00, 1360501-01, 1361101-00, 1361101-01, 1361101-02, 1361101-03, 1361102-00, 1361102-01, 1361102-02, 1361102-03, 1361602-00, 1361602-01, 1361602-02, 1361604-02, 1460503-01, 1461101-01, 1461101-02, 1461101-03, 1461102-01, 1461102-02, 1461102-03, 1461104-01, 1461104-02, 1461104-03, 1461105-01, 1461105-02, 1461105-03, 1461109-01, 1461109-02, 1461109A01, 1461109A02, 1461602-00, 1462101-03, 1462101-04, 1462102-02, 1462102-03, 1561110-00, 2061101-01... (Other models you can see in the webshop)

with barrel socket ø6(6.5)mm

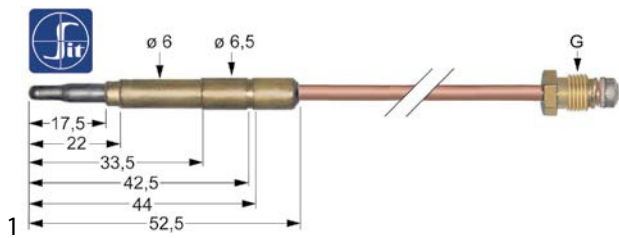
thermocouples SIT



**Part No.** 107617 **Ref. No.** 201669

**description** thermocouple SIT M10x1 L 600mm plug connection ø6.0(6.5)mm

**For models:** 1260301-00, 1260301-01, 1260302-00, 1260302-01, 1460302-01, 1460302-02, 2060301-01, 2060301-02



**Part No.** 107601 **Ref. No.** 201668

**description** thermocouple SIT M8x1 L 600mm plug connection ø6.0(6.5)mm

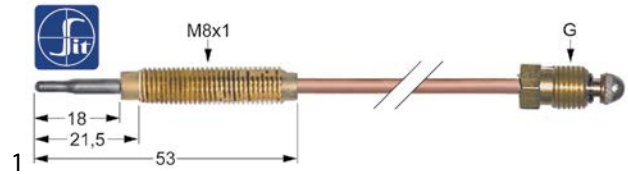
**For models:** 1261301-00, 1261301-01, 1261301-02, 1261601-00, 1261601-01, 1361301-00, 1361301-01, 1361301-02, 1361301-03, 1361601-00, 1361601-01, 1361601-02, 1461601-00, 2061301-01

threaded thermocouples

threaded thermocouples standard

with socket with thread M8x1

SIT



**Part No.** 107645 **Ref. No.** 201538

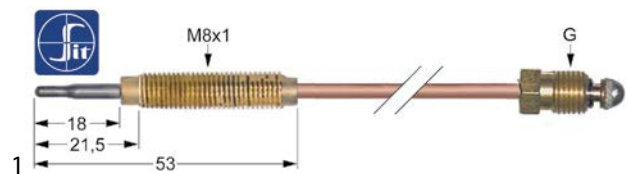
**description** thermocouple SIT M10x1 L 1500mm M8x1

**accessories for** 107645



**Part No.** 102067 **Ref. No.** 201524

nut thread M8x1 H 3mm brass Qty 1 pcs type SEF 1



**Part No.** 107643 **Ref. No.** 201533

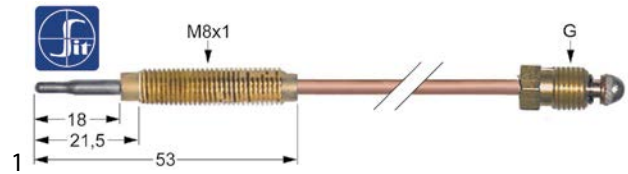
**description** thermocouple SIT M10x1 L 600mm M8x1

**accessories for** 107643



**Part No.** 102067 **Ref. No.** 201524

nut thread M8x1 H 3mm brass Qty 1 pcs type SEF 1



**Part No.** 107632 **Ref. No.** 201352, 201532, 201539

**description** thermocouple SIT M8x1 L 1000mm M8x1

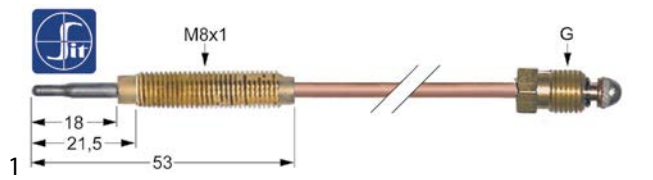
**For models:** 0261301-00, 0263401-00, 0263401-01, 1263401-00, 1263402-00, 1263402-01, 1263402-02, 1263404-00, 1263404-01, 1263404-02, 1263405-00, 1263405-01, 1263413-02, 1263414-02, 1363401-00, 1363402-00, 1363402-01, 1363402-02, 1363403-00, 1363403-01, 1363403-02, 1363403-03, 1363403-04, 1363403-05, 1363404-00, 1363404-01, 1363404-02, 1363404-03, 1363405-00, 1363405-01, 1363413-03, 1363415-05, 1463501-04, 1463501-05, 1464802-01, 1464802-02, 1464803-01, 1464803-02, 1464803-03, 1464808-01, 1464808-02, 1464808-03, 1464809-01, 1464809-02, 1464809-03, 1464810-01, 1464810-02, 1464811-01, 1464811-02, 1464812-00... (Other models you can see in the webshop)


**accessories for** 107632

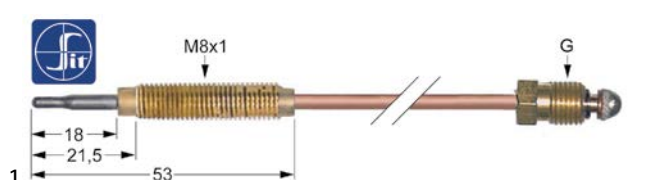


**Part No.** 102067 **Ref. No.** 201524

nut thread M8x1 H 3mm brass Qty 1 pcs type SEF 1

<b>Part No.</b>	107633	<b>Ref. No.</b>	201534
<b>description</b>	thermocouple SIT M8x1 L 1200mm M8x1		
<b>For models:</b>	1463501-00		
<b>accessories for</b>	107633		
	<b>Part No.</b>	102067	<b>Ref. No.</b> 201524
	nut thread M8x1 H 3mm brass Qty 1 pcs type SEF 1		



<b>Part No.</b>	107629	<b>Ref. No.</b>	201530
<b>description</b>	thermocouple SIT M8x1 L 450mm M8x1		

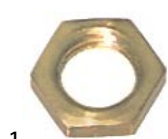
## accessories

## displays




<b>Part No.</b>	101414	<b>Ref. No.</b>	201554
<b>description</b>	display soldering connection		
<b>For models:</b>	2062801-00, 2062801A00, 2062801B00, 2062801C00, 2062802-00, 20628022-0, 20628022-1, 20628022-2, 2062802A00, 2062802B00, 2062802C00, 2062803-00, 20628033-0, 20628033-1, 20628033-2, 2062803A00, 2062803B00, 2062803C00, 2062804-00, 20628044-0, 20628044-1, 20628044-2, 2062804A00, 2062804B00, 2062804C00, 2062806-00, 2062806A00, 2062806B00, 2062806B01, 2062806B02, 2062806B03, 2062806C00, 2062806C01, 2062806C02, 2062806C03, 2062901-00, 20629011-0, 20629011-1, 20629011-2, 2062901A00, 2062901B00, 2062901B01, 2062901B02, 2062901B03, 2062901B04, 2062901B05, 2062901C00, 2062901C01, 2062901C02, 2062901C03... (Other models you can see in the webshop)		

## nuts



<b>Part No.</b>	102067	<b>Ref. No.</b>	201524
<b>description</b>	nut thread M8x1 H 3mm brass Qty 1 pcs type SEF 1		
<b>For models:</b>	0260301-00, 0260302-00, 0260501-00, 0261101-00, 0261101-01, 0261102-00, 0261102-01, 0261103-00, 0261103-01, 0261301-00, 0261601-00, 0263401-00, 0263401-01, 1263401-00, 1263402-00, 1263402-01, 1263402-02, 1263404-00, 1263404-01, 1263404-02, 1263405-00, 1263405-01, 1263413-02, 1263414-02, 1363401-00, 1363402-00, 1363402-01, 1363402-02, 1363403-00, 1363403-01, 1363403-02, 1363403-03, 1363403-04, 1363403-05, 1363404-00, 1363404-01, 1363404-02, 1363404-03, 1363405-00, 1363405-01, 1363413-03, 1363415-05, 14621011-0, 1462831-00, 1462832-00, 1462833-00, 1462834-00, 1462835-00, 1462836-00, 1462837-00... (Other models you can see in the webshop)		



<b>Part No.</b>	100965	<b>Ref. No.</b>	201525
<b>description</b>	thermocouple nut thread M8x1 H 15mm WS 11 brass Qty 1 pcs		
<b>For models:</b>	0263401-00, 0263401-01, 1263401-00, 1263402-00, 1263402-01, 1263402-02, 1263404-00, 1263404-01, 1263404-02, 1263405-00, 1263405-01, 1263413-02, 1263414-02, 1363401-00, 1363402-00, 1363402-01, 1363402-02, 1363403-00, 1363403-01, 1363403-02, 1363403-03, 1363403-04, 1363403-05, 1363404-00, 1363404-01, 1363404-02, 1363404-03, 1363405-00, 1363405-01, 1363413-03, 1363415-05, 1464802-01, 1464802-02, 1464803-01, 1464803-02, 1464803-03, 1464808-01, 1464808-02, 1464808-03, 1464809-01, 1464809-02, 1464809-03, 1464810-01, 1464810-02, 1464811-01, 1464811-02, 1464812-00, 1464812-01, 1464812-02, 2063401-00... (Other models you can see in the webshop)		

## SCREWS



<b>Part No.</b>	101262	<b>Ref. No.</b>	201123
<b>description</b>	thermocouple fitting thread M10x1 Qty 1 pcs		
<b>For models:</b>	1462101-03, 1462101-04, 2062901B02, 2062901C02, 2062902B02, 2062902C02, 2063404-05, 2063404-06, 2063404-07, 2063407-05, 2063407-06, 2063407-07, 2063416-02, 2063419-02, 2063503-06, 2063503-07, 2063508-05, 2063508-06		

## interrupters



<b>Part No.</b>	101258	<b>Ref. No.</b>	201478 203478
<b>description</b>	interrupter thread M10x1		
<b>For models:</b>	0260301-00, 0260301-01, 0260302-00, 0260302-01, 1260301-00, 1260301-01, 1260302-00, 1260302-01, 1460302-00, 1460302-01, 1460302-02, 2060301-00, 2060301-01, 2060301-02, 20628022-0, 20628022-1, 20628022-2, 20628033-0, 20628033-1, 20628033-2, 20628044-0, 20628044-1, 20628044-2, 20629011-0, 20629011-1, 20629011-2, 20629022-0, 20629022-1, 20629022-2, 2160501-00		


## ignition bridges



<b>Part No.</b>	104296	<b>Ref. No.</b>	201620
<b>description</b>	ignition bridge L 330mm		
<b>For models:</b>	14621011-0, 2060501-00, 2060501-01, 20605011-0		





			
1			
<b>Part No.</b>	105930	<b>Ref. No.</b>	201612
<b>description</b>	ignition bridge L 530mm		


## gas burners


### hob burners


#### producer-specific hob burners


MKN


burner head 29mm


			
1			
<b>Part No.</b>	104214	<b>Ref. No.</b>	201863
<b>description</b>	air mixing tube ID ø 12mm C		
<b>For models:</b>	1260501-00, 1263401-00, 1263402-00, 1263402-01, 1263402-02, 1263404-00, 1263404-01, 1263404-02, 1263413-02, 1263414-02, 1360501-00, 1360501-01, 1363401-00, 1363402-00, 1363402-01, 1363402-02, 1363403-00, 1363403-01, 1363403-02, 1363403-03, 1363403-04, 1363403-05, 1363404-00, 1363404-01, 1363404-02, 1363404-03, 1363413-03, 1363415-05, 1460503-01, 1464802-01, 1464802-02, 1464803-01, 1464803-02, 1464803-03, 1464808-01, 1464808-02, 1464808-03, 1464809-01, 1464809-02, 1464809-03, 1464810-01, 1464810-02, 1464811-01, 1464811-02, 2063401-00, 2063401-01, 2063401-02, 2063401-03, 2063401-04, 2063401-05... (Other models you can see in the webshop)		


			
1			
<b>Part No.</b>	104215	<b>Ref. No.</b>	201864
<b>description</b>	air mixing tube ID ø 14mm D		
<b>For models:</b>	0261601-00, 1261301-00, 1261301-01, 1261301-02, 1261601-00, 1261601-01, 1261602-00, 1261602-01, 1261602-02, 1261602-03, 1261604-03, 1263402-00, 1263402-01, 1263402-02, 1263404-00, 1263404-01, 1263404-02, 1263413-02, 1263414-02, 1361301-00, 1361301-01, 1361301-02, 1361301-03, 1361601-00, 1361601-01, 1361601-02, 1361602-00, 1361602-01, 1361602-02, 1361604-02, 1363402-00, 1363402-01, 1363402-02, 1363403-00, 1363403-01, 1363403-02, 1363403-03, 1363403-04, 1363403-05, 1363404-00, 1363404-01, 1363404-02, 1363404-03, 1363413-03, 1363415-05, 1461601-00, 1461602-00, 14621011-0, 1462802B00, 1462804B00... (Other models you can see in the webshop)		

			
1			
<b>Part No.</b>	103090	<b>Ref. No.</b>	201618
<b>description</b>	burner cap C ø 78mm		
<b>For models:</b>	0263401-00, 0263401-01, 1263401-00, 1263402-00, 1263402-01, 1263402-02, 1263404-00, 1263404-01, 1263404-02, 1263413-02, 1263414-02, 1363401-00, 1363402-00, 1363402-01, 1363402-02, 1363403-00, 1363403-01, 1363403-02, 1363403-03, 1363403-04, 1363403-05, 1363404-00, 1363404-01, 1363404-02, 1363404-03, 1363413-03, 1363415-05, 1464802-01, 1464802-02, 1464803-01, 1464803-02, 1464803-03, 1464808-01, 1464808-02, 1464808-03, 1464809-01, 1464809-02, 1464809-03, 1464810-01, 1464810-02, 1464811-01, 1464811-02, 2063401-00, 2063401-01, 2063401-02, 2063401-03, 2063401-04, 2063401-05, 2063401-06, 20634011-0... (Other models you can see in the webshop)		

			
1			
<b>Part No.</b>	104362	<b>Ref. No.</b>	201619
<b>description</b>	burner cap D ø 94mm with central hole		
<b>For models:</b>	2063401-00, 20634011-0, 2063402-00, 20634022-0, 2063403-00, 2063404-00, 2063405-00, 20634055-0, 2063406-00, 2063407-00, 2063413-00, 2063414-00, 2063415-00, 2063417-00, 2063418-00, 2083202A00, 2083501B00, 2083501C00, 2083502B00, 2083502B01, 2083502C00, 2083502C01		

			
1			
<b>Part No.</b>	104088	<b>Ref. No.</b>	201855 550069
<b>description</b>	burner head C for burner cap ø 78mm H 29mm		
<b>For models:</b>	0263401-00, 2063401-00, 20634011-0, 2063402-00, 20634022-0, 2063403-00, 2063404-00, 2063405-00, 20634055-0, 2063406-00, 2063407-00, 2063413-00, 2063414-00, 2063415-00, 2063417-00, 2063418-00, 2163401-00, 2163402-00, 2163403-00, 2163404-00, 2163405-00, 2163406-00, 2163407-00		

			
1			
<b>Part No.</b>	104089	<b>Ref. No.</b>	201856 550070
<b>description</b>	burner head D for burner cap ø 94mm H 29mm		
<b>For models:</b>	2063401-00, 20634011-0, 2063402-00, 20634022-0, 2063403-00, 2063404-00, 2063405-00, 20634055-0, 2063406-00, 2063407-00, 2063413-00, 2063414-00, 2063415-00, 2063417-00, 2063418-00, 2083202A00, 2083501B00, 2083501C00, 2083502B00, 2083502B01, 2083502C00, 2083502C01		

			
1			
<b>Part No.</b>	104098	<b>Ref. No.</b>	201842
<b>description</b>	burner lower part		
<b>For models:</b>	1263401-00, 1263402-00, 1263402-01, 1263402-02, 1263404-00, 1263404-01, 1263404-02, 1263413-02, 1263414-02, 1363401-00, 1363402-00, 1363402-01, 1363402-02, 1363403-00, 1363403-01, 1363403-02, 1363403-03, 1363403-04, 1363403-05, 1363404-00, 1363404-01, 1363404-02, 1363404-03, 1363413-03, 1363415-05, 1464802-01, 1464802-02, 1464803-01, 1464803-02, 1464803-03, 1464808-01, 1464808-02, 1464808-03, 1464809-01, 1464809-02, 1464809-03, 1464810-01, 1464810-02, 1464811-01, 1464811-02, 2063401-00, 2063401-01, 2063401-02, 2063401-03, 2063401-04, 2063401-05, 2063401-06, 20634011-0, 2063402-00, 2063402-01... (Other models you can see in the webshop)		

1 gas components



1			
Part No.		Ref. No.	201843
description	burner lower part		

2			
Part No.	104205	Ref. No.	211020
description	gasket C for burner head		
For models:	0263401-00, 0263401-01, 1263401-00, 1263402-00, 1263402-01, 1263402-02, 1263404-00, 1263404-01, 1263404-02, 1263413-02, 1263414-02, 1363401-00, 1363402-00, 1363402-01, 1363402-02, 1363403-00, 1363403-01, 1363403-02, 1363403-03, 1363403-04, 1363403-05, 1363404-00, 1363404-01, 1363404-02, 1363404-03, 1363413-03, 1363415-05, 1464802-01, 1464802-02, 1464803-01, 1464803-02, 1464803-03, 1464808-01, 1464808-02, 1464808-03, 1464809-01, 1464809-02, 1464809-03, 1464810-01, 1464810-02, 1464811-01, 1464811-02, 2063401-00, 2063401-01, 2063401-02, 2063401-03, 2063401-04, 2063401-05, 2063401-06, 20634011-0... (Other models you can see in the webshop)		

1			
Part No.	104206	Ref. No.	211021
description	gasket D for burner head		
For models:	1464803-02, 1464803-03, 1464808-02, 1464808-03, 1464809-02, 1464809-03, 2063401-00, 2063401-03, 2063401-04, 2063401-05, 2063401-06, 20634011-0, 2063402-00, 2063402-04, 2063402-05, 2063402-06, 20634022-0, 2063403-00, 2063403-07, 2063403-08, 2063403-09, 2063403-10, 2063404-00, 2063404-04, 2063404-05, 2063404-06, 2063404-07, 2063405-00, 2063405-04, 2063405-05, 2063405-06, 20634055-0, 2063406-00, 2063406-07, 2063406-08, 2063406-09, 2063406-10, 2063407-00, 2063407-04, 2063407-05, 2063407-06, 2063407-07, 2063413-00, 2063413-02, 2063414-00, 2063414-03, 2063415-00, 2063415-05, 2063416-02, 2063417-00... (Other models you can see in the webshop)		

1			
Part No.	104212	Ref. No.	211018
description	O-ring Viton thickness 3mm ID ø 32.5mm Qty 1 pcs		
For models:	0263401-00, 0263401-01, 1220501-00, 1220501-01, 1220501-02, 1220502-00, 1220502-01, 1220802-00, 1220802-01, 1222507-00, 1222509-00, 1263401-00, 1263402-00, 1263402-01, 1263402-02, 1263404-00, 1263404-01, 1263404-02, 1263413-02, 1263414-02, 1320501-00, 1320502-00, 1320802-00, 1322507-00, 1322509-00, 1363401-00, 1363402-00, 1363402-01, 1363402-02, 1363403-00, 1363403-01, 1363403-02, 1363403-03, 1363403-04, 1363403-05, 1363404-00, 1363404-01, 1363404-02, 1363404-03, 1363413-03, 1363415-05, 1422513B00, 1422513B01, 1422515B01, 1422515B02, 1422701-00, 1422701-01, 1422701-02, 1422701-03, 1422702-00... (Other models you can see in the webshop)		


1			
Part No.	104204	Ref. No.	204457
description	spacer piece		
For models:	1464803-01, 1464803-02, 1464803-03, 1464808-01, 1464808-02, 1464808-03, 1464809-01, 1464809-02, 1464809-03, 2063401-00, 2063401-01, 2063401-02, 2063401-03, 2063401-04, 2063401-05, 2063401-06, 20634011-0, 2063402-00, 2063402-01, 2063402-02, 2063402-03, 2063402-04, 2063402-05, 2063402-06, 20634022-0, 2063403-00, 2063403-01, 2063403-02, 2063403-03, 2063403-04, 2063403-05, 2063403-06, 2063403-07, 2063403-08, 2063403-09, 2063403-10, 2063404-00, 2063404-01, 2063404-02, 2063404-03, 2063404-04, 2063404-05, 2063404-06, 2063404-07, 2063405-00, 2063405-01, 2063405-02, 2063405-03, 2063405-04, 2063405-05... (Other models you can see in the webshop)		


1			
Part No.	104213	Ref. No.	201845
description	venturi C/D		
For models:	1263401-00, 1263402-00, 1263402-01, 1263402-02, 1263404-00, 1263404-01, 1263404-02, 1263413-02, 1263414-02, 1363401-00, 1363402-00, 1363402-01, 1363402-02, 1363403-00, 1363403-01, 1363403-02, 1363403-03, 1363403-04, 1363403-05, 1363404-00, 1363404-01, 1363404-02, 1363404-03, 1363413-03, 1363415-05, 1464802-01, 1464802-02, 1464803-01, 1464803-02, 1464803-03, 1464808-01, 1464808-02, 1464808-03, 1464809-01, 1464809-02, 1464809-03, 1464810-01, 1464810-02, 1464811-01, 1464811-02, 2063401-00, 2063401-01, 2063401-02, 2063401-03, 2063401-04, 2063401-05, 2063401-06, 20634011-0, 2063402-00, 2063402-01... (Other models you can see in the webshop)		


burner head 34mm			
1			
Part No.	104214	Ref. No.	201863
description	air mixing tube ID ø 12mm C		
For models:	1260501-00, 1263401-00, 1263402-00, 1263402-01, 1263402-02, 1263404-00, 1263404-01, 1263404-02, 1263413-02, 1263414-02, 1360501-00, 1360501-01, 1363401-00, 1363402-00, 1363402-01, 1363402-02, 1363403-00, 1363403-01, 1363403-02, 1363403-03, 1363403-04, 1363403-05, 1363404-00, 1363404-01, 1363404-02, 1363404-03, 1363413-03, 1363415-05, 1460503-01, 1464802-01, 1464802-02, 1464803-01, 1464803-02, 1464803-03, 1464808-01, 1464808-02, 1464808-03, 1464809-01, 1464809-02, 1464809-03, 1464810-01, 1464810-02, 1464811-01, 1464811-02, 2063401-00, 2063401-01, 2063401-02, 2063401-03, 2063401-04, 2063401-05... (Other models you can see in the webshop)		


1			
Part No.	104215	Ref. No.	201864
description	air mixing tube ID ø 14mm D		
For models:	0261601-00, 1261301-00, 1261301-01, 1261301-02, 1261601-00, 1261601-01, 1261602-00, 1261602-01, 1261602-02, 1261602-03, 1261604-03, 1263402-00, 1263402-01, 1263402-02, 1263404-00, 1263404-01, 1263404-02, 1263413-02, 1263414-02, 1361301-00, 1361301-01, 1361301-02, 1361301-03, 1361601-00, 1361601-01, 1361601-02, 1361602-00, 1361602-01, 1361602-02, 1361604-02, 1363402-00, 1363402-01, 1363402-02, 1363403-00, 1363403-01, 1363403-02, 1363403-03, 1363403-04, 1363403-05, 1363404-00, 1363404-01, 1363404-02, 1363404-03, 1363413-03, 1363415-05, 1461601-00, 1461602-00, 14621011-0, 1462802B00, 1462804B00... (Other models you can see in the webshop)		






			
<b>Part No.</b>	104606	<b>Ref. No.</b>	201767
<b>description</b>	air mixing tube ID ø 16mm E		
<b>For models:</b>	1464803-02, 1464803-03, 1464808-02, 1464808-03, 1464809-02, 1464809-03, 2063401-03, 2063401-04, 2063401-05, 2063401-06, 2063402-04, 2063402-05, 2063402-06, 2063403-07, 2063403-08, 2063403-09, 2063403-10, 2063404-04, 2063404-05, 2063404-06, 2063404-07, 2063405-04, 2063405-05, 2063405-06, 2063406-07, 2063406-08, 2063406-09, 2063406-10, 2063407-04, 2063407-05, 2063407-06, 2063407-07, 2063413-02, 2063414-03, 2063415-05, 2063416-02, 2063417-03, 2063418-05, 2063419-02, 3063401-02, 3063401-03, 3063401-04, 3063402-02, 3063402-03, 3063402-04, 3063405-02, 3063405-03, 3063405-04		


			
<b>Part No.</b>	103090	<b>Ref. No.</b>	201618
<b>description</b>	burner cap C ø 78mm		
<b>For models:</b>	0263401-00, 0263401-01, 1263401-00, 1263402-00, 1263402-01, 1263402-02, 1263404-00, 1263404-01, 1263404-02, 1263413-02, 1263414-02, 1363401-00, 1363402-00, 1363402-01, 1363402-02, 1363403-00, 1363403-01, 1363403-02, 1363403-03, 1363403-04, 1363403-05, 1363404-00, 1363404-01, 1363404-02, 1363404-03, 1363413-03, 1363415-05, 1464802-01, 1464802-02, 1464803-01, 1464803-02, 1464803-03, 1464808-01, 1464808-02, 1464808-03, 1464809-01, 1464809-02, 1464809-03, 1464810-01, 1464810-02, 1464811-01, 1464811-02, 2063401-00, 2063401-01, 2063401-02, 2063401-03, 2063401-04, 2063401-05, 2063401-06, 20634011-0... (Other models you can see in the webshop)		

			
<b>Part No.</b>	103092	<b>Ref. No.</b>	201661
<b>description</b>	burner cap D ø 87mm		
<b>For models:</b>	1263402-00, 1263402-01, 1263402-02, 1263404-00, 1263404-01, 1263404-02, 1263413-02, 1263414-02, 1363402-00, 1363402-01, 1363402-02, 1363403-00, 1363403-01, 1363403-02, 1363403-03, 1363403-04, 1363403-05, 1363404-00, 1363404-01, 1363404-02, 1363404-03, 1363413-03, 1363415-05, 1464802-01, 1464802-02, 1464803-01, 1464803-02, 1464803-03, 1464808-01, 1464808-02, 1464808-03, 1464809-01, 1464809-02, 1464809-03, 1464810-01, 1464810-02, 1464811-01, 1464811-02, 2063401-01, 2063401-02, 2063402-01, 2063402-02, 2063402-03, 2063402-04, 2063402-05, 2063402-06, 2063403-01, 2063403-02, 2063403-03, 2063403-04, 2063403-05, 2063403-06... (Other models you can see in the webshop)		

			
<b>Part No.</b>	105620	<b>Ref. No.</b>	201769
<b>description</b>	burner cap E ø 114mm with central hole bore ø 2.7mm		
<b>For models:</b>	1464803-02, 1464803-03, 1464808-02, 1464808-03, 1464809-02, 1464809-03, 2063401-03, 2063401-04, 2063401-05, 2063401-06, 2063402-04, 2063402-05, 2063402-06, 2063403-07, 2063403-08, 2063403-09, 2063403-10, 2063404-04, 2063404-05, 2063404-06, 2063404-07, 2063405-04, 2063405-05, 2063405-06, 2063406-07, 2063406-08, 2063406-09, 2063406-10, 2063407-04, 2063407-05, 2063407-06, 2063407-07, 2063413-02, 2063414-03, 2063415-05, 2063416-02, 2063417-03, 2063418-05, 2063419-02, 3063401-02, 3063401-03, 3063401-04, 3063402-02, 3063402-03, 3063402-04, 3063405-02, 3063405-03, 3063405-04		


			
<b>Part No.</b>	104207	<b>Ref. No.</b>	201102
<b>description</b>	burner head C for burner cap ø 78mm H 34mm		
<b>For models:</b>	0263401-01, 1263401-00, 1263402-00, 1263402-01, 1263402-02, 1263404-00, 1263404-01, 1263404-02, 1263413-02, 1263414-02, 1363401-00, 1363402-00, 1363402-01, 1363402-02, 1363403-00, 1363403-01, 1363403-02, 1363403-03, 1363403-04, 1363403-05, 1363404-00, 1363404-01, 1363404-02, 1363404-03, 1363413-03, 1363415-05, 1464802-01, 1464802-02, 1464803-01, 1464803-02, 1464803-03, 1464808-01, 1464808-02, 1464808-03, 1464809-01, 1464809-02, 1464809-03, 1464810-01, 1464810-02, 1464811-01, 1464811-02, 2063401-01, 2063401-02, 2063401-03, 2063401-04, 2063401-05, 2063401-06, 2063402-01, 2063402-02, 2063402-03... (Other models you can see in the webshop)		


							
<b>Part No.</b>	104208	<b>Ref. No.</b>	201104				
<b>description</b>	burner head D for burner cap ø 87mm H 34mm						
<b>For models:</b>	1263402-00, 1263402-01, 1263402-02, 1263404-00, 1263404-01, 1263404-02, 1263413-02, 1263414-02, 1363402-00, 1363402-01, 1363402-02, 1363403-00, 1363403-01, 1363403-02, 1363403-03, 1363403-04, 1363403-05, 1363404-00, 1363404-01, 1363404-02, 1363404-03, 1363413-03, 1363415-05, 1464802-01, 1464802-02, 1464803-01, 1464803-02, 1464803-03, 1464808-01, 1464808-02, 1464808-03, 1464809-01, 1464809-02, 1464809-03, 1464810-01, 1464810-02, 1464811-01, 1464811-02, 2063401-01, 2063401-02, 2063402-01, 2063402-02, 2063402-03, 2063402-04, 2063402-05, 2063402-06, 2063403-01, 2063403-02, 2063403-03, 2063403-04, 2063403-05, 2063403-06... (Other models you can see in the webshop)						
<b>accessories for</b>	104208						
	<table border="1"> <tr> <td><b>Part No.</b></td> <td>103092</td> <td><b>Ref. No.</b></td> <td>201661</td> </tr> </table>	<b>Part No.</b>	103092	<b>Ref. No.</b>	201661		
<b>Part No.</b>	103092	<b>Ref. No.</b>	201661				
		burner cap D ø 87mm					


			
<b>Part No.</b>	104453	<b>Ref. No.</b>	201157
<b>description</b>	burner head D for burner cap ø 87mm H 41mm		





			
1			
<b>Part No.</b>	104604	<b>Ref. No.</b>	201768
<b>description</b>	burner head E for burner cap ø 114mm H 34mm		
<b>For models:</b>	1464803-02, 1464803-03, 1464808-02, 1464808-03, 1464809-02, 1464809-03, 2063401-03, 2063401-04, 2063401-05, 2063401-06, 2063402-04, 2063402-05, 2063402-06, 2063403-07, 2063403-08, 2063403-09, 2063403-10, 2063404-04, 2063404-05, 2063404-06, 2063404-07, 2063405-04, 2063405-05, 2063405-06, 2063406-07, 2063406-08, 2063406-09, 2063406-10, 2063407-04, 2063407-05, 2063407-06, 2063407-07, 2063413-02, 2063414-03, 2063415-05, 2063416-02, 2063417-03, 2063418-05, 2063419-02, 3063401-02, 3063401-03, 3063401-04, 3063402-02, 3063402-03, 3063402-04, 3063405-02, 3063405-03, 3063405-04		


			
2			
<b>Part No.</b>	104098	<b>Ref. No.</b>	201842
<b>description</b>	burner lower part		
<b>For models:</b>	1263401-00, 1263402-00, 1263402-01, 1263402-02, 1263404-00, 1263404-01, 1263404-02, 1263413-02, 1263414-02, 1363401-00, 1363402-00, 1363402-01, 1363402-02, 1363403-00, 1363403-01, 1363403-02, 1363403-03, 1363403-04, 1363403-05, 1363404-00, 1363404-01, 1363404-02, 1363404-03, 1363413-03, 1363415-05, 1464802-01, 1464802-02, 1464803-01, 1464803-02, 1464803-03, 1464808-01, 1464808-02, 1464808-03, 1464809-01, 1464809-02, 1464809-03, 1464810-01, 1464810-02, 1464811-01, 1464811-02, 2063401-00, 2063401-01, 2063401-02, 2063401-03, 2063401-04, 2063401-05, 2063401-06, 20634011-0, 2063402-00, 2063402-01... (Other models you can see in the webshop)		

			
1			
<b>Part No.</b>	104205	<b>Ref. No.</b>	211020
<b>description</b>	gasket C for burner head		
<b>For models:</b>	0263401-00, 0263401-01, 1263401-00, 1263402-00, 1263402-01, 1263402-02, 1263404-00, 1263404-01, 1263404-02, 1263413-02, 1263414-02, 1363401-00, 1363402-00, 1363402-01, 1363402-02, 1363403-00, 1363403-01, 1363403-02, 1363403-03, 1363403-04, 1363403-05, 1363404-00, 1363404-01, 1363404-02, 1363404-03, 1363413-03, 1363415-05, 1464802-01, 1464802-02, 1464803-01, 1464803-02, 1464803-03, 1464808-01, 1464808-02, 1464808-03, 1464809-01, 1464809-02, 1464809-03, 1464810-01, 1464810-02, 1464811-01, 1464811-02, 2063401-00, 2063401-01, 2063401-02, 2063401-03, 2063401-04, 2063401-05, 2063401-06, 20634011-0, 2063402-00, 2063402-01... (Other models you can see in the webshop)		


			
1			
<b>Part No.</b>	104206	<b>Ref. No.</b>	211021
<b>description</b>	gasket D for burner head		
<b>For models:</b>	1464803-02, 1464803-03, 1464808-02, 1464808-03, 1464809-02, 1464809-03, 2063401-00, 2063401-03, 2063401-04, 2063401-05, 2063401-06, 20634011-0, 2063402-00, 2063402-04, 2063402-05, 2063402-06, 20634022-0, 2063403-00, 2063403-07, 2063403-08, 2063403-09, 2063403-10, 2063404-00, 2063404-04, 2063404-05, 2063404-06, 2063404-07, 2063405-00, 2063405-04, 2063405-05, 2063405-06, 20634055-0, 2063406-00, 2063406-07, 2063406-08, 2063406-09, 2063406-10, 2063407-00, 2063407-04, 2063407-05, 2063407-06, 2063407-07, 2063413-00, 2063413-02, 2063414-00, 2063414-03, 2063415-00, 2063415-05, 2063416-02, 2063417-00... (Other models you can see in the webshop)		


			
1			
<b>Part No.</b>	104212	<b>Ref. No.</b>	211018
<b>description</b>	O-ring Viton thickness 3mm ID ø 32.5mm Qty 1 pcs		
<b>For models:</b>	0263401-00, 0263401-01, 1220501-00, 1220501-01, 1220501-02, 1220502-00, 1220502-01, 1220802-00, 1220802-01, 1222507-00, 1222509-00, 1263401-00, 1263402-00, 1263402-01, 1263402-02, 1263404-00, 1263404-01, 1263404-02, 1263413-02, 1263414-02, 1320501-00, 1320502-00, 1320802-00, 1322507-00, 1322509-00, 1363401-00, 1363402-00, 1363402-01, 1363402-02, 1363403-00, 1363403-01, 1363403-02, 1363403-03, 1363403-04, 1363403-05, 1363404-00, 1363404-01, 1363404-02, 1363404-03, 1363413-03, 1363415-05, 1422513B00, 1422513B01, 1422515B01, 1422515B02, 1422701-00, 1422701-01, 1422701-02, 1422701-03, 1422702-00... (Other models you can see in the webshop)		


			
1			
<b>Part No.</b>	104204	<b>Ref. No.</b>	204457
<b>description</b>	spacer piece		
<b>For models:</b>	1464803-01, 1464803-02, 1464803-03, 1464808-01, 1464808-02, 1464808-03, 1464809-01, 1464809-02, 1464809-03, 2063401-00, 2063401-01, 2063401-02, 2063401-03, 2063401-04, 2063401-05, 2063401-06, 20634011-0, 2063402-00, 2063402-01, 2063402-02, 2063402-03, 2063402-04, 2063402-05, 2063402-06, 20634022-0, 2063403-00, 2063403-01, 2063403-02, 2063403-03, 2063403-04, 2063403-05, 2063403-06, 2063403-07, 2063403-08, 2063403-09, 2063403-10, 2063404-00, 2063404-01, 2063404-02, 2063404-03, 2063404-04, 2063404-05, 2063404-06, 2063404-07, 2063405-00, 2063405-01, 2063405-02, 2063405-03, 2063405-04, 2063405-05... (Other models you can see in the webshop)		


			
1			
<b>Part No.</b>	104213	<b>Ref. No.</b>	201845
<b>description</b>	venturi C/D		
<b>For models:</b>	1263401-00, 1263402-00, 1263402-01, 1263402-02, 1263404-00, 1263404-01, 1263404-02, 1263413-02, 1263414-02, 1363401-00, 1363402-00, 1363402-01, 1363402-02, 1363403-00, 1363403-01, 1363403-02, 1363403-03, 1363403-04, 1363403-05, 1363404-00, 1363404-01, 1363404-02, 1363404-03, 1363413-03, 1363415-05, 1464802-01, 1464802-02, 1464803-01, 1464803-02, 1464803-03, 1464808-01, 1464808-02, 1464808-03, 1464809-01, 1464809-02, 1464809-03, 1464810-01, 1464810-02, 1464811-01, 1464811-02, 2063401-00, 2063401-01, 2063401-02, 2063401-03, 2063401-04, 2063401-05, 2063401-06, 20634011-0, 2063402-00, 2063402-01... (Other models you can see in the webshop)		





			
1			
<b>Part No.</b>	104605	<b>Ref. No.</b>	201766
<b>description</b>	venturi E long		
<b>For models:</b>	1464803-02, 1464803-03, 1464808-02, 1464808-03, 1464809-02, 1464809-03, 2063401-03, 2063401-04, 2063401-05, 2063401-06, 2063402-04, 2063402-05, 2063402-06, 2063403-07, 2063403-08, 2063403-09, 2063403-10, 2063404-04, 2063404-05, 2063404-06, 2063404-07, 2063405-04, 2063405-05, 2063405-06, 2063406-07, 2063406-08, 2063406-09, 2063406-10, 2063407-04, 2063407-05, 2063407-06, 2063407-07, 2063413-02, 2063414-03, 2063415-05, 2063416-02, 2063417-03, 2063418-05, 2063419-02, 3063401-02, 3063401-03, 3063401-04, 3063402-02, 3063402-03, 3063402-04, 3063405-02, 3063405-03, 3063405-04		


			
1			
<b>Part No.</b>	105926	<b>Ref. No.</b>	201876
<b>description</b>	venturi E short		

pan supports			
			
1			
<b>Part No.</b>	210227	<b>Ref. No.</b>	201877
<b>description</b>	pan support W 275mm L 350mm		
<b>For models:</b>	0263401-01, 1263401-00, 1263402-00, 1263402-01, 1263402-02, 1263404-00, 1263404-01, 1263404-02, 1263413-02, 1263414-02, 1363401-00, 1363402-00, 1363402-01, 1363402-02, 1363403-00, 1363403-01, 1363403-02, 1363403-03, 1363403-04, 1363403-05, 1363404-00, 1363404-01, 1363404-02, 1363404-03, 1363413-03, 1363415-05, 1464802-01, 1464802-02, 1464810-01, 1464810-02, 1464811-01, 1464811-02, 2163401-01, 2163401-02, 2163401-03, 2163401-04, 2163401-05, 2163402-01, 2163402-02, 2163402-03, 2163402-04, 2163402-05, 2163403-01, 2163403-02, 2163403-03, 2163403-04, 2163403-05, 2163403-06, 2163403-07, 2163403-08... (Other models you can see in the webshop)		

			
1			
<b>Part No.</b>	210228	<b>Ref. No.</b>	201866 201878 445035
<b>description</b>	pan support W 350mm L 350mm H 35mm		
<b>For models:</b>	1464803-01, 1464808-01, 1464809-01, 2063401-00, 2063401-01, 2063401-02, 20634011-0, 2063402-00, 2063402-01, 2063402-02, 2063402-03, 20634022-0, 2063403-00, 2063403-01, 2063403-02, 2063403-03, 2063403-04, 2063403-05, 2063403-06, 2063404-00, 2063404-01, 2063404-02, 2063404-03, 2063405-00, 2063405-01, 2063405-02, 2063405-03, 20634055-0, 2063406-00, 2063406-01, 2063406-02, 2063406-03, 2063406-04, 2063406-05, 2063406-06, 2063407-00, 2063407-01, 2063407-02, 2063407-03, 2063413-00, 2063413-01, 2063414-00, 2063414-01, 2063414-02, 2063415-00, 2063415-01, 2063415-02, 2063415-03, 2063415-04, 2063416-00... (Other models you can see in the webshop)		

			
1			
<b>Part No.</b>	210231	<b>Ref. No.</b>	206001
<b>description</b>	pan support W 370mm L 700mm		
<b>For models:</b>	1464803-02, 1464803-03, 1464808-02, 1464808-03, 1464809-02, 1464809-03, 2063401-03, 2063401-04, 2063401-05, 2063401-06, 2063402-04, 2063402-05, 2063402-06, 2063403-07, 2063403-08, 2063403-09, 2063403-10, 2063404-04, 2063404-05, 2063404-06, 2063404-07, 2063405-04, 2063405-05, 2063405-06, 2063406-07, 2063406-08, 2063406-09, 2063406-10, 2063407-04, 2063407-05, 2063407-06, 2063407-07, 2063413-02, 2063414-03, 2063415-05, 2063416-02, 2063417-03, 2063418-05, 2063419-02, 3063401-02, 3063401-03, 3063401-04, 3063402-02, 3063402-03, 3063402-04, 3063405-02, 3063405-03, 3063405-04		

reducers for pan supports			
			
1			
<b>Part No.</b>	210015	<b>Ref. No.</b>	201848
<b>description</b>	reducer for pan support L 250mm W 250mm chrome-plated steel suitable for MKN		

accessories			
reducers for pan supports			
			
1			
<b>Part No.</b>	210015	<b>Ref. No.</b>	201848
<b>description</b>	reducer for pan support L 250mm W 250mm chrome-plated steel suitable for MKN		





## pan supports



1

Part No.	210227	Ref. No.	201877
description	pan support W 275mm L 350mm		
For models:	0263401-01, 1263401-00, 1263402-00, 1263402-01, 1263402-02, 1263404-00, 1263404-01, 1263404-02, 1263413-02, 1263414-02, 1363401-00, 1363402-00, 1363402-01, 1363402-02, 1363403-00, 1363403-01, 1363403-02, 1363403-03, 1363403-04, 1363403-05, 1363404-00, 1363404-01, 1363404-02, 1363404-03, 1363413-03, 1363415-05, 1464802-01, 1464802-02, 1464810-01, 1464810-02, 1464811-01, 1464811-02, 2163401-01, 2163401-02, 2163401-03, 2163401-04, 2163401-05, 2163402-01, 2163402-02, 2163402-03, 2163402-04, 2163402-05, 2163403-01, 2163403-02, 2163403-03, 2163403-04, 2163403-05, 2163403-06, 2163403-07, 2163403-08... (Other models you can see in the webshop)		



2

Part No.	210228	Ref. No.	201866 201878 445035
description	pan support W 350mm L 350mm H 35mm		
For models:	1464803-01, 1464808-01, 1464809-01, 2063401-00, 2063401-01, 2063401-02, 2063401-0, 2063402-00, 2063402-01, 2063402-02, 2063402-03, 2063402-0, 2063403-00, 2063403-01, 2063403-02, 2063403-03, 2063403-04, 2063403-05, 2063403-06, 2063404-00, 2063404-01, 2063404-02, 2063404-03, 2063405-00, 2063405-01, 2063405-02, 2063405-03, 2063405-0, 2063406-00, 2063406-01, 2063406-02, 2063406-03, 2063406-04, 2063406-05, 2063406-06, 2063407-00, 2063407-01, 2063407-02, 2063407-03, 2063413-00, 2063413-01, 2063414-00, 2063414-01, 2063414-02, 2063415-00, 2063415-01, 2063415-02, 2063415-03, 2063415-04, 2063416-00... (Other models you can see in the webshop)		



1

Part No.	210231	Ref. No.	206001
description	pan support W 370mm L 700mm		
For models:	1464803-02, 1464803-03, 1464808-02, 1464808-03, 1464809-02, 1464809-03, 2063401-03, 2063401-04, 2063401-05, 2063401-06, 2063402-04, 2063402-05, 2063402-06, 2063403-07, 2063403-08, 2063403-09, 2063403-10, 2063404-04, 2063404-05, 2063404-06, 2063404-07, 2063405-04, 2063405-05, 2063405-06, 2063406-07, 2063406-08, 2063406-09, 2063406-10, 2063407-04, 2063407-05, 2063407-06, 2063407-07, 2063413-02, 2063414-03, 2063415-05, 2063416-02, 2063417-03, 2063418-05, 2063419-02, 3063401-02, 3063401-03, 3063401-04, 3063402-02, 3063402-03, 3063402-04, 3063405-02, 3063405-03, 3063405-04		

## air mixers



1

Part No.	104210	Ref. No.	201541
description	air mixing sleeve L 40mm ED ø 42mm ID ø 40mm SS		
For models:	0263401-00, 0263401-01		



1

Part No.	104214	Ref. No.	201863
description	air mixing tube ID ø 12mm C		
For models:	1260501-00, 1263401-00, 1263402-00, 1263402-01, 1263402-02, 1263404-00, 1263404-01, 1263404-02, 1263413-02, 1263414-02, 1360501-00, 1360501-01, 1363401-00, 1363402-00, 1363402-01, 1363402-02, 1363403-00, 1363403-01, 1363403-02, 1363403-03, 1363403-04, 1363403-05, 1363404-00, 1363404-01, 1363404-02, 1363404-03, 1363413-03, 1363415-05, 1460503-01, 1464802-01, 1464802-02, 1464803-01, 1464803-02, 1464803-03, 1464808-01, 1464808-02, 1464808-03, 1464809-01, 1464809-02, 1464809-03, 1464810-01, 1464810-02, 1464811-01, 1464811-02, 2063401-00, 2063401-01, 2063401-02, 2063401-03, 2063401-04, 2063401-05... (Other models you can see in the webshop)		



1

Part No.	104215	Ref. No.	201864
description	air mixing tube ID ø 14mm D		
For models:	0261601-00, 1261301-00, 1261301-01, 1261301-02, 1261601-00, 1261601-01, 1261602-00, 1261602-01, 1261602-02, 1261602-03, 1261604-03, 1263402-00, 1263402-01, 1263402-02, 1263404-00, 1263404-01, 1263404-02, 1263413-02, 1263414-02, 1361301-00, 1361301-01, 1361301-02, 1361301-03, 1361601-00, 1361601-01, 1361601-02, 1361602-00, 1361602-01, 1361602-02, 1361604-02, 1363402-00, 1363402-01, 1363402-02, 1363403-00, 1363403-01, 1363403-02, 1363403-03, 1363403-04, 1363403-05, 1363404-00, 1363404-01, 1363404-02, 1363404-03, 1363413-03, 1363415-05, 1461601-00, 1461602-00, 14621011-0, 1462802B00, 1462804B00... (Other models you can see in the webshop)		



1

Part No.	104606	Ref. No.	201767
description	air mixing tube ID ø 16mm E		
For models:	1464803-02, 1464803-03, 1464808-02, 1464808-03, 1464809-02, 1464809-03, 2063401-03, 2063401-04, 2063401-05, 2063401-06, 2063402-04, 2063402-05, 2063402-06, 2063403-07, 2063403-08, 2063403-09, 2063403-10, 2063404-04, 2063404-05, 2063404-06, 2063404-07, 2063405-04, 2063405-05, 2063405-06, 2063406-07, 2063406-08, 2063406-09, 2063406-10, 2063407-04, 2063407-05, 2063407-06, 2063407-07, 2063413-02, 2063414-03, 2063415-05, 2063416-02, 2063417-03, 2063418-05, 2063419-02, 3063401-02, 3063401-03, 3063401-04, 3063402-02, 3063402-03, 3063402-04, 3063405-02, 3063405-03, 3063405-04		



1

Part No.	105926	Ref. No.	201876
description	venturi E short		



bar burners

bar burners




<b>Part No.</b>	105889	<b>Ref. No.</b>	201608
<b>description</b>	bar burner 1-row ømm W 28mm H 42mm L 295mm oven with ignition bridge		
<b>For models:</b>	0261101-01, 0261102-01, 0261103-01, 1261101-00, 1261101-01, 1261101-02, 1261102-00, 1261102-01, 1261102-02, 1361101-00, 1361101-01, 1361101-02, 1361101-03, 1361102-00, 1361102-01, 1361102-02, 1361102-03, 1461101-00, 1461101-01, 1461101-02, 1461101-03, 1461102-00, 1461102-01, 1461102-02, 1461102-03, 1461103-00, 1461104-01, 1461104-02, 1461104-03, 1461105-01, 1461105-02, 1461105-03, 1461109-01, 1461109-02, 1461109A01, 1461109A02, 1462102-00, 1462102-00_V2, 1462102-01, 1462102-02, 1462102-03, 1561110-00, 2061101-00, 2061101-01, 2061101-02, 2061101-03, 2061101-04, 2061101-05, 2061102-00, 2061102-01... (Other models you can see in the webshop)		



<b>Part No.</b>	105935	<b>Ref. No.</b>	201617
<b>description</b>	bar burner 2 row L 265mm W 120mm ømm H 73mm fryer		
<b>For models:</b>	0260301-00, 0260301-01		




<b>Part No.</b>	105936	<b>Ref. No.</b>	201686
<b>description</b>	bar burner 2 row L 268mm W 170mm ømm H 50mm fryer		
<b>For models:</b>	1260301-00, 1260301-01		

<b>spare parts for</b>	105936			
	<b>Part No.</b>	100412	<b>Ref. No.</b>	—
	burner nozzle thread 1/8" 4 slits for flame spreader			



<b>Part No.</b>	105931	<b>Ref. No.</b>	201687
<b>description</b>	bar burner 2 row L 405mm W 170mm ømm H 50mm fryer		
<b>For models:</b>	1260302-00, 1260302-01, 1460302-01, 1460302-02, 2060301-01, 2060301-02		

<b>spare parts for</b>	105931			
	<b>Part No.</b>	100412	<b>Ref. No.</b>	—
	burner nozzle thread 1/8" 4 slits for flame spreader			



<b>Part No.</b>	105890	<b>Ref. No.</b>	810121
<b>description</b>	bar burner 2 row L 460mm W 310mm ømm H 30mm bain marie		
<b>For models:</b>	14621011-0, 2060501-00, 2060501-01, 20605011-0		



<b>Part No.</b>	105923	<b>Ref. No.</b>	201604
<b>description</b>	bar burner 4 flames ømm W 125mm H 100mm L 300mm		



<b>Part No.</b>	105906	<b>Ref. No.</b>	201007
<b>description</b>	bar burner 4 row L 405mm W 250mm ømm H 40mm		
<b>For models:</b>	1462101-01, 1462101-02, 1462101-03, 1462101-04, 2063404-01, 2063404-02, 2063404-03, 2063404-04, 2063404-05, 2063404-06, 2063404-07, 2063407-01, 2063407-02, 2063407-03, 2063407-04, 2063407-05, 2063407-06, 2063407-07, 2063416-00, 2063416-01, 2063416-02, 2063419-00, 2063419-01, 2063419-02, 2063503-01, 2063503-02, 2063503-03, 2063503-04, 2063503-05, 2063503-06, 2063503-07, 2063508-00, 2063508-01, 2063508-02, 2063508-03, 2063508-04, 2063508-05, 2063508-06		





<b>Part No.</b>	105925	<b>Ref. No.</b>	811906
<b>description</b>	bar burner 4 row L 510mm W 255mm ømm H 145mm		
<b>For models:</b>	1261601-00, 1261601-01, 1261602-00, 1261602-01, 1261602-02, 1261602-03, 1261604-03, 1361601-00, 1361601-01, 1361601-02, 1361602-00, 1361602-01, 1361602-02, 1361604-02, 1461601-00, 1461602-00, 2061602-00, 2061602-01, 2061603-00, 2061603-01, 2061603-02, 2061604-01, 3061602-00		





			
1			
<b>Part No.</b>	104426	<b>Ref. No.</b>	811507
<b>description</b>	bar burner 4 row L 670mm W 338mm ømm H 70mm kettle		
<b>For models:</b>	1462802B00, 2062801-04, 2062801-05, 2062801-06, 2062801A04, 2062801A05, 2062801A06, 2062801B04, 2062801B05, 2062801B06, 2062801C04, 2062801C05, 2062801C06, 2062802-04, 2062802-05, 2062802-06, 2062802A04, 2062802A05, 2062802A06, 2062802B04, 2062802B05, 2062802B06, 2062802B07, 2062802C04, 2062802C05, 2062802C06, 3062801-00, 3062801-01, 3062801A00, 3062801A01, 3062801B00, 3062801B01, 3062801C00, 3062801C01, 3062802-00, 3062802-01, 3062802A00, 3062802A01, 3062802B00, 3062802B01, 3062802B02, 3062802C00, 3062802C01		


			
2			
<b>Part No.</b>	104428	<b>Ref. No.</b>	811512
<b>description</b>	bar burner 6 row L 660mm W 335mm ømm H 70mm kettle		
<b>For models:</b>	1462804B00, 2062803-04, 2062803-05, 2062803-06, 2062803A04, 2062803A05, 2062803A06, 2062803B04, 2062803B05, 2062803B06, 2062803C04, 2062803C05, 2062803C06, 2062804-04, 2062804-05, 2062804-06, 2062804A04, 2062804A05, 2062804A06, 2062804B04, 2062804B05, 2062804B06, 2062804B07, 2062804C04, 2062804C05, 2062804C06, 3062803-00, 3062803-01, 3062803A00, 3062803A01, 3062803B00, 3062803B01, 3062803C00, 3062803C01, 3062804-00, 3062804-01, 3062804A00, 3062804A01, 3062804B00, 3062804B01, 3062804B02, 3062804C00, 3062804C01		

			
1			
<b>Part No.</b>	105603	<b>Ref. No.</b>	201627
<b>description</b>	bar burner 6 row tilting bratt pan		
<b>For models:</b>	2061401-00, 2061401-01, 2061401A00, 2061401B00, 2061401C00, 2061402-00, 2061402-01, 2061402A00, 2061402B00, 2061402C00, 2061403-00, 2061403-01, 2061403-0, 2061403A00, 2061403B00, 2061403C00, 2061404-00, 2061404-01, 2061404-0, 2061404A00, 2061404B00, 2061404C00, 3061403-00, 3061403-01, 3061403A00, 3061403B00, 3061403C00, 3061404-00, 3061404A00, 3061404B00, 3061404C00		


			
1			
<b>Part No.</b>	105924	<b>Ref. No.</b>	201602
<b>description</b>	bar burner 8 flames ømm W 30mm H 65mm L 285mm		


			
1			
<b>Part No.</b>	104200	<b>Ref. No.</b>	201505
<b>description</b>	bar burner ømm W 28mm H 42mm L 295mm flange width 35mm flange length 70mm kettle		
<b>For models:</b>	0261101-01, 0261102-01, 0261103-01, 1261101-00, 1261101-01, 1261101-02, 1261102-00, 1261102-01, 1261102-02, 1361101-00, 1361101-01, 1361101-02, 1361101-03, 1361102-00, 1361102-01, 1361102-02, 1361102-03, 1461101-00, 1461101-01, 1461101-02, 1461101-03, 1461102-00, 1461102-01, 1461102-02, 1461102-03, 1461103-00, 1461104-01, 1461104-02, 1461104-03, 1461105-01, 1461105-02, 1461105-03, 1461109-01, 1461109-02, 1461109A01, 1461109A02, 1462102-00, 1462102-00_V2, 1462102-01, 1462102-02, 1462102-03, 1561110-00, 2061101-00, 2061101-01, 2061101-02, 2061101-03, 2061101-04, 2061101-05, 2061102-00, 2061102-01... (Other models you can see in the webshop)		


			
1			
<b>Part No.</b>	104202	<b>Ref. No.</b>	201507 201728
<b>description</b>	bar burner ømm W 28mm H 53mm L 385mm flange width 35mm flange length 70mm tilting bratt pan		
<b>For models:</b>	2061401-05, 2061401-06, 2061401-07, 2061401-08, 2061401A05, 2061401A06, 2061401A07, 2061401A08, 2061401B05, 2061401B06, 2061401B07, 2061401B08, 2061401C05, 2061401C06, 2061401C07, 2061401C08, 2061402-05, 2061402-06, 2061402-07, 2061402A05, 2061402A06, 2061402A07, 2061402B05, 2061402B06, 2061402B07, 2061402C05, 2061402C06, 2061402C07, 2061403-03, 2061403-04, 2061403-05, 2061403A03, 2061403A04, 2061403A05, 2061403B03, 2061403B04, 2061403B05, 2061403C03, 2061403C04, 2061403C05, 2061404-03, 2061404-04, 2061404-05, 2061404A03, 2061404A04, 2061404A05, 2061404B03, 2061404B04, 2061404B05, 2061404C03... (Other models you can see in the webshop)		

			
1			
<b>Part No.</b>	104201	<b>Ref. No.</b>	201506
<b>description</b>	bar burner with ignition bridge ømm W 28mm H 42mm L 295mm flange width 35mm flange length 70mm kettle		
<b>For models:</b>	2062801-00, 2062801A00, 2062801B00, 2062801C00, 2062802-00, 2062802-2, 2062802A00, 2062802B00, 2062802C00, 2062901B03, 2062901B04, 2062901B05, 2062901C03, 2062901C04, 2062901C05		








			
1			
<b>Part No.</b>	105907	<b>Ref. No.</b>	201611
<b>description</b>	bar burner with ignition bridge ømm W 28mm H 42mm L 385mm flange width 35mm flange length 70mm tilting bratt pan		
<b>For models:</b>	1462101-00, 14621011-0, 2061401-02, 2061401-03, 2061401-04, 2061401A01, 2061401A02, 2061401A03, 2061401B01, 2061401B02, 2061401B03, 2061401C01, 2061401C02, 2061401C03, 2061402-02, 2061402-03, 2061402-04, 2061402A01, 2061402A02, 2061402A03, 2061402B01, 2061402B02, 2061402B03, 2061402C01, 2061402C02, 2061402C03, 2063404-00, 2063407-00, 2063503-00, 2063505-00		

			
1			
<b>Part No.</b>	104203	<b>Ref. No.</b>	201508
<b>description</b>	bar burner with ignition bridge ømm W 28mm H 53mm L 390mm flange width 35mm flange length 70mm kettle		
<b>For models:</b>	2062803-00, 20628033-2, 2062803A00, 2062803B00, 2062803C00, 2062804-00, 20628044-2, 2062804A00, 2062804B00, 2062804C00, 2062806-00, 2062806A00, 2062806B00, 2062806B01, 2062806B02, 2062806B03, 2062806C00, 2062806C01, 2062806C02, 2062806C03, 2062901-00, 20629011-2, 2062901A00, 2062901B00, 2062901B01, 2062901B02, 2062901B03, 2062901B04, 2062901B05, 2062901C00, 2062901C01, 2062901C02, 2062901C03, 2062901C04, 2062901C05, 2062902-00, 20629022-2, 2062902A00, 2062902B00, 2062902B01, 2062902B02, 2062902B03, 2062902B04, 2062902B05, 2062902C00, 2062902C01, 2062902C02, 2062902C03, 2062902C04, 2062902C05... (Other models you can see in the webshop)		

			
2			
<b>Part No.</b>	105908	<b>Ref. No.</b>	201720
<b>description</b>	bar burner with ignition bridge ømm W 28mm H 42mm L 385mm flange width 35mm flange length 70mm tilting bratt pan		
<b>For models:</b>	2061401-05, 2061401-06, 2061401-07, 2061401-08, 2061401A05, 2061401A06, 2061401A07, 2061401A08, 2061401B05, 2061401B06, 2061401B07, 2061401B08, 2061401C05, 2061401C06, 2061401C07, 2061401C08, 2061402-05, 2061402-06, 2061402-07, 2061402A05, 2061402A06, 2061402A07, 2061402B05, 2061402B06, 2061402B07, 2061402C05, 2061402C06, 2061402C07, 2061403-02, 2061403-03, 2061403-04, 2061403-05, 2061403A02, 2061403A03, 2061403A04, 2061403A05, 2061403B02, 2061403B03, 2061403B04, 2061403B05, 2061403C02, 2061403C03, 2061403C04, 2061403C05, 2061404-02, 2061404-03, 2061404-04, 2061404-05, 2061404A02, 2061404A03... (Other models you can see in the webshop)		

round burners

			
1			
<b>Part No.</b>	105893	<b>Ref. No.</b>	201622
<b>description</b>	round burner ø 250mm 20-25kW		
<b>For models:</b>	1463501-00, 1463501-01, 1463501-02, 1463501-03, 1463501-04, 1463501-05, 2063501-00, 2063501-01, 2063501-02, 2063501-03, 2063501-04, 2063501-05, 2063501-06, 20635011-0, 2063502-00, 2063502-01, 2063502-02, 2063502-03, 2063502-04, 2063502-05, 2063502-06, 2063502-07, 2063502-08, 2063502-09, 2063502-10, 20635022-0, 2063503-00, 2063503-01, 2063503-02, 2063503-03, 2063503-04, 2063503-05, 2063503-06, 2063503-07, 20635033-0, 2063504-00, 2063504-01, 2063504-02, 2063504-03, 20635044-0, 2063505-00, 20635055-0, 2063506-00, 2063506-01, 2063506-02, 2063506-03, 2063506-04, 2063506-05, 20635066-0, 2063507-00... (Other models you can see in the webshop)		
<b>spare parts for</b>	105893		
		<b>Part No.</b>	102761
		<b>Ref. No.</b>	205267
		locking screw thread 3/8" WS 17	
		<b>Part No.</b>	102762
		<b>Ref. No.</b>	205268
		locking screw with test nipple thread 3/8" WS 17	
		<b>Part No.</b>	528520
		<b>Ref. No.</b>	211004
		gasket copper ED ø 22mm ID ø 16mm thickness 2mm	

			
1			
<b>Part No.</b>	105937	<b>Ref. No.</b>	201729
<b>description</b>	bar burner with ignition bridge ømm W 28mm H 42mm L 385mm flange width 35mm flange length 70mm tilting bratt pan		
<b>For models:</b>	2061401-05, 2061401-06, 2061401-07, 2061401-08, 2061401A05, 2061401A06, 2061401A07, 2061401A08, 2061401B05, 2061401B06, 2061401B07, 2061401B08, 2061401C05, 2061401C06, 2061401C07, 2061401C08, 2061402-05, 2061402-06, 2061402-07, 2061402A05, 2061402A06, 2061402A07, 2061402B05, 2061402B06, 2061402B07, 2061402C05, 2061402C06, 2061402C07, 2161401-03, 2161401-04, 2161401-05, 2161401-06, 2161401A03, 2161401A04, 2161401A05, 2161401A06, 2161401B03, 2161401B04, 2161401B05, 2161401B06, 2161401C03, 2161401C04, 2161401C05, 2161401C06, 2161402-03, 2161402-04, 2161402-05, 2161402A03, 2161402A04, 2161402A05... (Other models you can see in the webshop)		



## forced air burners



1

<b>Part No.</b>	107842	<b>Ref. No.</b>	201178
<b>description</b>	burner L 150mm ø 50mm 20kW combi-steamer		
<b>For models:</b>	CGG11-L, CGG11-R, CGG12-L, CGG12-R, CGG21-L, CGG21-R, CGG22-L, CGG22-R, CGG61-L, CGG61-R, CGG62-L, CGG62-R, CSG11-L, CSG11-R, CSG11-R-DG, CSG12-L, CSG12-R, CSG12-R-DG, CSG21-L, CSG21-R, CSG21-R-DG, CSG22-L, CSG22-R, CSG22-R-DG, CSG61-L, CSG61-R, CSG61-R-DG, CSG62-L, CSG62-R, CSG62-R-DG		



1

<b>Part No.</b>	107877	<b>Ref. No.</b>	201174
<b>description</b>	connecting fitting for burner MKN combi-steamer		
<b>For models:</b>	CGG61-L, CGG61-R, CGG62-L, CGG62-R, CSG61-L, CSG61-R, CSG61-R-DG, CSG62-L, CSG62-R, CSG62-R-DG		



1

<b>Part No.</b>	107878	<b>Ref. No.</b>	201172
<b>description</b>	connecting fitting for burner MKN combi-steamer		
<b>For models:</b>	CGG11-L, CGG11-R, CGG12-L, CGG12-R, CGG21-L, CGG21-R, CGG22-L, CGG22-R, CSG11-L, CSG11-R, CSG11-R-DG, CSG12-L, CSG12-R, CSG12-R-DG, CSG21-L, CSG21-R, CSG21-R-DG, CSG22-L, CSG22-R, CSG22-R-DG		



1

<b>Part No.</b>	108150	<b>Ref. No.</b>	201182
<b>description</b>	venturi MKN combi-steamer with gasket		
<b>For models:</b>	CGG11-L, CGG11-R, CGG12-L, CGG12-R, CGG21-L, CGG21-R, CGG22-L, CGG22-R, CGG61-L, CGG61-R, CGG62-L, CGG62-R, CSG11-L, CSG11-R, CSG11-R-DG, CSG12-L, CSG12-R, CSG12-R-DG, CSG21-L, CSG21-R, CSG21-R-DG, CSG22-L, CSG22-R, CSG22-R-DG, CSG61-L, CSG61-R, CSG61-R-DG, CSG62-L, CSG62-R, CSG62-R-DG		

## accessories

## nozzle holders

1

<b>Part No.</b>		<b>Ref. No.</b>	201581
<b>description</b>	nozzle holder external nozzle ø 2.1mm internal nozzle complete with nozzle tube ø 12mm		
<b>For models:</b>	2063413-02, 2063414-03, 2063415-05, 2063416-02, 2063417-03, 2063418-05, 2063419-02		

1

<b>Part No.</b>		<b>Ref. No.</b>	10013991 10013991-ZF01X
<b>description</b>	nozzle holder external nozzle ø 2.9mm internal nozzle ø 2.9mm ET M17x1 IT M12x1 M12x1 tube ø 10mm		

1

<b>Part No.</b>	101595	<b>Ref. No.</b>	201667
<b>description</b>	nozzle holder external nozzle ø bore ø1.55mm internal nozzle ø bore ø1.35mm		
<b>For models:</b>	1263401-00, 1263402-00, 1263402-01, 1263402-02, 1263404-00, 1263404-01, 1263404-02, 1263413-02, 1263414-02, 1263401-00, 1363402-00, 1363402-01, 1363402-02, 1363403-00, 1363403-01, 1363403-02, 1363403-03, 1363403-04, 1363403-05, 1363404-00, 1363404-01, 1363404-02, 1363404-03, 1363413-03, 1363415-05		


1

<b>Part No.</b>	101858	<b>Ref. No.</b>	201723
<b>description</b>	nozzle holder external nozzle ø bore ø2.05mm internal nozzle ø bore ø1.85mm		
<b>For models:</b>	1263402-00, 1263402-01, 1263402-02, 1263404-00, 1263404-01, 1263404-02, 1263413-02, 1263414-02, 1263402-00, 1263402-01, 1363402-02, 1363403-00, 1363403-01, 1363403-02, 1363403-03, 1363403-04, 1363403-05, 1363404-00, 1363404-01, 1363404-02, 1363404-03, 1363413-03, 1363415-05		







			
1			
<b>Part No.</b>	102771	<b>Ref. No.</b>	201772
<b>description</b>	nozzle holder external nozzle ø bore ø2.35mm internal nozzle ø bore ø2.00mm		
<b>For models:</b>	1263405-00, 1263405-01, 1363405-00, 1363405-01, 1464803-02, 1464803-03, 1464808-02, 1464808-03, 1464809-02, 1464809-03, 1464812-00, 1464812-01, 1464812-02, 2063401-03, 2063401-04, 2063401-05, 2063401-06, 2063402-04, 2063402-05, 2063402-06, 2063403-07, 2063403-08, 2063403-09, 2063403-10, 2063404-04, 2063404-05, 2063404-06, 2063404-07, 2063405-04, 2063405-05, 2063405-06, 2063406-07, 2063406-08, 2063406-09, 2063406-10, 2063407-04, 2063407-05, 2063407-06, 2063407-07, 2063420-00, 2063420-01, 2063420-02, 2163422-00, 2163422-01, 2163422-02, 3063401-02, 3063401-03, 3063401-04, 3063402-02, 3063402-03... (Other models you can see in the webshop)		


			
1			
<b>Part No.</b>		<b>Ref. No.</b>	202185
<b>description</b>	nozzle holder with cap pipe outlet ø M17x1mm nozzle mounting M12x1		


## gas nozzles


### main nozzles


			
1			
<b>Part No.</b>	100431	<b>Ref. No.</b>	N/A
<b>description</b>	gas injector thread 1/8" bore ø 1.3mm LPG		


			
1			
<b>Part No.</b>	106826	<b>Ref. No.</b>	201585
<b>description</b>	gas injector thread 1/8" bore ø 1.9mm		

			
1			
<b>Part No.</b>	100430	<b>Ref. No.</b>	N/A
<b>description</b>	gas injector thread 1/8" bore ø 2.2mm natural gas		

			
gas nozzles M12x1			
1			
<b>Part No.</b>	100301	<b>Ref. No.</b>	201831
<b>description</b>	gas injector thread M12x1 WS 14 bore ø 1.55mm		
<b>For models:</b>	1263402-00, 1263402-01, 1263402-02, 1263404-00, 1263404-01, 1263404-02, 1263413-02, 1263414-02, 1363402-00, 1363402-01, 1363402-02, 1363403-00, 1363403-01, 1363403-02, 1363403-03, 1363403-04, 1363403-05, 1363404-00, 1363404-01, 1363404-02, 1363404-03, 1363413-03, 1363415-05, 1464803-02, 1464803-03, 1464808-02, 1464808-03, 1464809-02, 1464809-03, 1464810-01, 1464810-02, 1464811-01, 1464811-02, 2063401-03, 2063401-04, 2063401-05, 2063401-06, 2063402-04, 2063402-05, 2063402-06, 2063403-07, 2063403-08, 2063403-09, 2063403-10, 2063404-04, 2063404-05, 2063404-06, 2063404-07, 2063405-04, 2063405-05... (Other models you can see in the webshop)		

			
1			
<b>Part No.</b>	100303	<b>Ref. No.</b>	201836
<b>description</b>	gas injector thread M12x1 WS 14 bore ø 2.05mm		
<b>For models:</b>	1263402-00, 1263402-01, 1263402-02, 1263404-00, 1263404-01, 1263404-02, 1263413-02, 1263414-02, 1363402-00, 1363402-01, 1363402-02, 1363403-00, 1363403-01, 1363403-02, 1363403-03, 1363403-04, 1363403-05, 1363404-00, 1363404-01, 1363404-02, 1363404-03, 1363413-03, 1363415-05, 1464808-02, 1464808-03, 1464809-02, 1464809-03, 1464810-01, 1464810-02, 1464811-01, 1464811-02, 2063402-04, 2063402-05, 2063402-06, 2063403-07, 2063403-08, 2063403-09, 2063403-10, 2063404-04, 2063404-05, 2063404-06, 2063404-07, 2063405-04, 2063405-05, 2063405-06, 2063406-07, 2063406-08, 2063406-09, 2063406-10, 2063407-04... (Other models you can see in the webshop)		

			
1			
<b>Part No.</b>	100309	<b>Ref. No.</b>	201773
<b>description</b>	gas injector thread M12x1 WS 14 bore ø 2.30mm		
<b>For models:</b>	1464803-02, 1464803-03, 1464808-02, 1464808-03, 1464809-02, 1464809-03, 2063401-03, 2063401-04, 2063401-05, 2063401-06, 2063402-04, 2063402-05, 2063402-06, 2063403-07, 2063403-08, 2063403-09, 2063403-10, 2063404-04, 2063404-05, 2063404-06, 2063404-07, 2063405-04, 2063405-05, 2063405-06, 2063406-07, 2063406-08, 2063406-09, 2063406-10, 2063407-04, 2063407-05, 2063407-06, 2063407-07, 3063401-02, 3063401-03, 3063401-04, 3063402-02, 3063402-03, 3063402-04, 3063405-02, 3063405-03, 3063405-04		

			
1			
<b>Part No.</b>	106329	<b>Ref. No.</b>	201858
<b>description</b>	gas injector thread M12x1 WS 14 bore ø 2.80mm		
<b>For models:</b>	1263402-02, 1263404-02, 1263413-02, 1263414-02, 1363403-05, 1363404-03, 1363413-03, 1363415-05		



## gas nozzles M15x1



1

<b>Part No.</b>	100337	<b>Ref. No.</b>	201808
<b>description</b>	gas injector thread M15x1 bore ø 1.60mm WS 17		



1

<b>Part No.</b>	100338	<b>Ref. No.</b>	201810
<b>description</b>	gas injector thread M15x1 bore ø 2.10mm WS 17		



1

<b>Part No.</b>	100331	<b>Ref. No.</b>	201812
<b>description</b>	gas injector thread M15x1 bore ø 2.70mm WS 17		

**For models:** 0263401-00, 0263401-01, 2063413-00, 2063413-01, 2063414-00, 2063414-01, 2063414-02, 2063415-00, 2063415-01, 2063415-02, 2063415-03, 2063415-04, 2063416-00, 2063416-01, 2063417-00, 2063417-01, 2063417-02, 2063418-00, 2063418-01, 2063418-02, 2063418-03, 2063418-04, 2063419-00, 2063419-01, 2163415-00, 2163416-00, 2163416-01, 2163417-00, 2163417-01, 2163417-02, 2163417-03, 2163418-00, 2163418-01, 2163419-00, 2163419-01, 2163420-00, 2163420-01, 2163420-02, 2163420-03, 2163421-00, 2163421-01, 3063413-00, 3063414-00, 3063417-00



1

<b>Part No.</b>	100334	<b>Ref. No.</b>	201811
<b>description</b>	gas injector thread M15x1 bore ø 3.50mm WS 17		

**For models:** 2063413-00, 2063413-01, 2063413-02, 2063414-00, 2063414-01, 2063414-02, 2063414-03, 2063415-00, 2063415-01, 2063415-02, 2063415-03, 2063415-04, 2063415-05, 2063416-00, 2063416-01, 2063416-02, 2063417-00, 2063417-01, 2063417-02, 2063417-03, 2063418-00, 2063418-01, 2063418-02, 2063418-03, 2063418-04, 2063418-05, 2063419-00, 2063419-01, 2063419-02, 2163415-00, 2163416-00, 2163416-01, 2163417-00, 2163417-01, 2163417-02, 2163417-03, 2163418-00, 2163418-01, 2163419-00, 2163419-01, 2163420-00, 2163420-01, 2163420-02, 2163420-03, 2163421-00, 2163421-01, 3063413-00, 3063414-00, 3063417-00

## pilot burner nozzles

## pilot burner nozzles JUNKERS

## CB 50203\_/503\_ series



1

<b>Part No.</b>	100220	<b>Ref. No.</b>	201547
-----------------	--------	-----------------	--------

**description** pilot burner nozzle LPG gas pressure 50mbar code 2 Qty 1 pcs suitable for JUNKERS CB503\_



1

<b>Part No.</b>	100222	<b>Ref. No.</b>	201641
-----------------	--------	-----------------	--------

**description** pilot burner nozzle LPG gas pressure 50mbar code 5 Qty 1 pcs suitable for JUNKERS CB50203\_

**For models:** 1462101-02, 1462101-03, 1462102-01, 1462102-02, 1463501-04, 1463501-05, 2060501-01, 2062806B02, 2062806B03, 2062806C02, 2062806C03, 2062901B02, 2062901B03, 2062901B04, 2062901B05, 2062901C02, 2062901C03, 2062901C04, 2062901C05, 2062902B02, 2062902B03, 2062902B04, 2062902B05, 2062902C02, 2062902C03, 2062902C04, 2062902C05, 2063404-04, 2063407-04, 2063501-03, 2063502-04, 2063502-05, 2063502-06, 2063502-07, 2063502-08, 2063502-09, 2063502-10, 2063503-03, 2063503-04, 2063503-05, 2063503-06, 2063503-07, 2063504-03, 2063506-03, 2063506-04, 2063506-05, 2063507-04, 2063507-05, 2063507-06, 2063507-07... (Other models you can see in the webshop)



1


<b>Part No.</b>	102524	<b>Ref. No.</b>	201546
-----------------	--------	-----------------	--------

**description** pilot burner nozzle natural gas gas pressure 25mbar code 26 Qty 10 pcs suitable for CB 503




pilot burner nozzles SIT

160 series



1

<b>Part No.</b>	107172	<b>Ref. No.</b>	201671
<b>description</b>	pilot burner nozzle SIT LPG code 25 Qty 1 pcs		
<b>For models:</b>	1260301-00, 1260301-01, 1260302-00, 1260302-01, 1260501-00, 1261101-00, 1261101-01, 1261101-02, 1261102-00, 1261102-01, 1261102-02, 1261301-00, 1261301-01, 1261301-02, 1261601-00, 1261601-01, 1261602-00, 1261602-01, 1261602-02, 1261602-03, 1261604-03, 1360501-00, 1360501-01, 1361101-00, 1361101-01, 1361101-02, 1361101-03, 1361102-00, 1361102-01, 1361102-02, 1361102-03, 1361301-00, 1361301-01, 1361301-02, 1361301-03, 1361601-00, 1361601-01, 1361601-02, 1361602-01, 1361602-02, 1361604-02, 1460302-01, 1460302-02, 1460503-01, 1461101-01, 1461101-02, 1461101-03, 1461102-01, 1461102-02... (Other models you can see in the webshop)		




2

<b>Part No.</b>	107174	<b>Ref. No.</b>	201672
<b>description</b>	pilot burner nozzle SIT natural gas code 41 Qty 1 pcs		
<b>For models:</b>	1260301-00, 1260301-01, 1260302-00, 1260302-01, 1260501-00, 1261101-01, 1261101-02, 1261102-01, 1261102-02, 1261301-00, 1261301-01, 1261301-02, 1261601-00, 1261601-01, 1261602-00, 1261602-01, 1261602-02, 1261602-03, 1261604-03, 1360501-00, 1360501-01, 1361101-01, 1361101-02, 1361101-03, 1361102-01, 1361102-02, 1361102-03, 1361301-00, 1361301-01, 1361301-02, 1361301-03, 1361601-00, 1361601-01, 1361601-02, 1361602-00, 1361602-01, 1361602-02, 1361604-02, 1460302-01, 1460302-02, 1460503-01, 1461101-02, 1461101-03, 1461102-02, 1461102-03, 1461104-02, 1461104-03, 1461105-02, 1461105-03, 1461109-01... (Other models you can see in the webshop)		


pilot burner nozzles (other)

MKN




1

<b>Part No.</b>	106228	<b>Ref. No.</b>	201806
<b>description</b>	pilot burner nozzle bore $\phi$ 0.6mm		
<b>For models:</b>	0263401-00, 0263401-01, 1263402-02, 1263404-02, 1263413-02, 1263414-02, 1363403-05, 1363404-03, 1363413-03, 1363415-05, 2063413-00, 2063413-01, 2063413-02, 2063414-00, 2063414-01, 2063414-02, 2063414-03, 2063415-00, 2063415-01, 2063415-02, 2063415-03, 2063415-04, 2063415-05, 2063416-00, 2063416-01, 2063416-02, 2063417-00, 2063417-01, 2063417-02, 2063417-03, 2063418-00, 2063418-01, 2063418-02, 2063418-03, 2063418-04, 2063418-05, 2063419-00, 2063419-01, 2063419-02, 2163401-00, 2163402-00, 2163403-00, 2163404-00, 2163405-00, 2163406-00, 2163407-00, 2163415-00, 2163416-00, 2163416-01, 2163417-00... (Other models you can see in the webshop)		




1

<b>Part No.</b>	100270	<b>Ref. No.</b>	201821
<b>description</b>	pilot burner nozzle LPG bore $\phi$ 0.2mm thread M8x0.75 T1: M8x1		
<b>For models:</b>	1263402-00, 1263402-01, 1263402-02, 1263404-00, 1263404-01, 1263404-02, 1263405-00, 1263405-01, 1263413-02, 1263414-02, 1363402-00, 1363402-01, 1363402-02, 1363403-00, 1363403-01, 1363403-02, 1363403-03, 1363403-04, 1363403-05, 1363404-00, 1363404-01, 1363404-02, 1363404-03, 1363405-00, 1363405-01, 1363413-03, 1363415-05, 1464803-02, 1464803-03, 1464808-02, 1464808-03, 1464809-02, 1464809-03, 1464810-01, 1464810-02, 1464811-01, 1464811-02, 1464812-00, 1464812-01, 1464812-02, 2063401-03, 2063401-04, 2063401-05, 2063401-06, 2063402-04, 2063402-05, 2063402-06, 2063403-07, 2063403-08, 2063403-09... (Other models you can see in the webshop)		



1

<b>Part No.</b>	100272	<b>Ref. No.</b>	201805
<b>description</b>	pilot burner nozzle natural gas bore $\phi$ 0.35mm		
<b>For models:</b>	1263402-00, 1263402-01, 1263402-02, 1263404-00, 1263404-01, 1263404-02, 1263405-00, 1263405-01, 1263413-02, 1263414-02, 1363402-00, 1363402-01, 1363402-02, 1363403-00, 1363403-01, 1363403-02, 1363403-03, 1363403-04, 1363403-05, 1363404-00, 1363404-01, 1363404-02, 1363404-03, 1363405-00, 1363405-01, 1363413-03, 1363415-05, 1464803-02, 1464803-03, 1464808-02, 1464808-03, 1464809-02, 1464809-03, 1464810-01, 1464810-02, 1464811-01, 1464811-02, 1464812-00, 1464812-01, 1464812-02, 2063401-03, 2063401-04, 2063401-05, 2063401-06, 2063402-04, 2063402-05, 2063402-06, 2063403-07, 2063403-08, 2063403-09... (Other models you can see in the webshop)		




1

<b>Part No.</b>	100271	<b>Ref. No.</b>	201822
<b>description</b>	pilot burner nozzle natural gas bore $\phi$ 0.3mm		

bypass nozzles


bypass nozzles EGA





1


<b>Part No.</b>	106825	<b>Ref. No.</b>	201833
<b>description</b>	bypass nozzle EGA bore $\phi$ 0.37mm		
<b>For models:</b>	1260501-00, 1263402-00, 1263404-00, 1360501-00, 1360501-01, 1363402-00, 1363402-01, 1363403-00, 1363403-01, 1363403-02, 1363403-03, 1363404-00, 1363404-01, 1464803-02, 1464808-02, 1464809-02, 1464810-01, 1464811-01, 2063401-03, 2063401-04, 2063402-04, 2063403-07, 2063403-08, 2063404-04, 2063404-05, 2063405-04, 2063406-07, 2063406-08, 2063407-04, 2063407-05, 2163401-02, 2163401-03, 2163402-03, 2163403-06, 2163403-07, 2163404-03, 2163404-04, 2163405-03, 2163406-06, 2163406-07, 2163407-03, 2163407-04, 3063401-02, 3063402-02, 3063405-02		





			
<b>Part No.</b>	100356	<b>Ref. No.</b>	201757
<b>description</b>	bypass nozzle EGA type 31248 series bore $\varnothing$ 0.55mm total length 23mm $\varnothing$ 5mm thread M5x0.5		
<b>For models:</b>	1460503-01, 1462101-01, 1462101-02, 1462101-03, 1462101-04, 1462102-00, 1462102-01, 1462102-02, 1462102-03, 2063404-01, 2063404-02, 2063404-03, 2063404-04, 2063404-05, 2063404-06, 2063404-07, 2063407-01, 2063407-02, 2063407-03, 2063407-04, 2063407-05, 2063407-06, 2063407-07, 2063416-00, 2063416-01, 2063416-02, 2063419-00, 2063419-01, 2063419-02, 2063503-01, 2063503-02, 2063503-03, 2063503-04, 2063503-05, 2063503-06, 2063503-07, 2063508-00, 2063508-01, 2063508-02, 2063508-03, 2063508-04, 2063508-05, 2063508-06, 2160501-00, 2160501-01, 2163404-01, 2163404-02, 2163404-03, 2163404-04, 2163404-05... (Other models you can see in the webshop)		


			
<b>Part No.</b>	100354	<b>Ref. No.</b>	201817
<b>description</b>	bypass nozzle EGA type 31248 series bore $\varnothing$ 0.5mm		
<b>For models:</b>	1263402-00, 1263404-00, 1363402-00, 1363402-01, 1363403-00, 1363403-01, 1363403-02, 1363403-03, 1363404-00, 1363404-01, 1464808-02, 1464809-02, 1464810-01, 1464811-01, 2063402-04, 2063403-07, 2063403-08, 2063404-04, 2063404-05, 2063405-04, 2063406-07, 2063406-08, 2063407-04, 2063407-05, 2163401-02, 2163401-03, 2163402-03, 2163403-06, 2163403-07, 2163404-03, 2163404-04, 2163405-03, 2163406-06, 2163406-07, 2163407-03, 2163407-04, 3063402-02, 3063405-02		


			
<b>Part No.</b>	100368	<b>Ref. No.</b>	201816
<b>description</b>	bypass nozzle EGA type 31248 series bore $\varnothing$ 0.6mm		
<b>For models:</b>	1464803-02, 1464808-02, 1464809-02, 2063401-03, 2063401-04, 2063402-04, 2063403-07, 2063403-08, 2063404-04, 2063404-05, 2063405-04, 2063406-07, 2063406-08, 2063407-04, 2063407-05, 3063401-02, 3063402-02, 3063405-02		


			
<b>Part No.</b>	100346	<b>Ref. No.</b>	201818
<b>description</b>	bypass nozzle EGA type 31248 series bore $\varnothing$ 0.85mm		
<b>For models:</b>	1464812-00, 1464812-01, 2063420-00, 2063420-01, 2163422-00, 2163422-01		


			
<b>Part No.</b>	100348	<b>Ref. No.</b>	201814
<b>description</b>	bypass nozzle EGA type 31248 series bore $\varnothing$ 1.1mm		
<b>For models:</b>	1462101-00, 1462101-0, 1462102-00_V2, 2063404-00, 2063407-00, 2063503-00, 2063505-00, 2163404-00, 2163407-00		


			
<b>Part No.</b>	100349	<b>Ref. No.</b>	201874
<b>description</b>	bypass nozzle EGA type 31248 series bore $\varnothing$ 1.8mm		
<b>For models:</b>	1462102-00_V2, 2163404-00, 2163407-00		


			
<b>Part No.</b>	100362	<b>Ref. No.</b>	201754
<b>description</b>	bypass nozzle EGA type 31248 series bore $\varnothing$ 1mm		
<b>For models:</b>	1261301-00, 1261301-01, 1261601-00, 1261601-01, 1261602-00, 1261602-01, 1361301-00, 1361301-01, 1361301-02, 1361601-00, 1361601-01, 1361601-02, 1361602-00, 1461601-00, 2061603-00, 2061603-01		


<b>bypass nozzles PEL20/21</b>			
			
<b>Part No.</b>	100553	<b>Ref. No.</b>	201796
<b>description</b>	bypass nozzle type PEL20/21 bore $\varnothing$ 0.4mm thread M5x0.5		
<b>For models:</b>	1263402-01, 1263402-02, 1263404-01, 1263404-02, 1263413-02, 1263414-02, 1363402-02, 1363403-04, 1363403-05, 1363404-02, 1363404-03, 1363413-03, 1363415-05, 1464803-03, 1464808-03, 1464809-03, 1464810-02, 1464811-02, 2063401-05, 2063401-06, 2063402-05, 2063402-06, 2063403-09, 2063403-10, 2063404-06, 2063404-07, 2063405-05, 2063405-06, 2063406-09, 2063406-10, 2063407-06, 2063407-07, 2163401-04, 2163401-05, 2163402-04, 2163402-05, 2163403-08, 2163403-09, 2163404-05, 2163404-06, 2163405-04, 2163405-05, 2163406-08, 2163406-09, 2163407-05, 2163407-06, 3063401-03, 3063401-04, 3063402-03, 3063402-04... (Other models you can see in the webshop)		

			
<b>Part No.</b>	100551	<b>Ref. No.</b>	201798
<b>description</b>	bypass nozzle type PEL20/21 bore $\varnothing$ 0.6mm thread M5x0.5		
<b>For models:</b>	1464803-03, 1464808-03, 1464809-03, 2063401-05, 2063401-06, 2063402-05, 2063402-06, 2063403-09, 2063403-10, 2063404-06, 2063404-07, 2063405-05, 2063405-06, 2063406-09, 2063406-10, 2063407-06, 2063407-07, 3063401-03, 3063401-04, 3063402-03, 3063402-04, 3063405-03, 3063405-04		


			
<b>Part No.</b>	100528	<b>Ref. No.</b>	201239
<b>description</b>	bypass nozzle type PEL20/21 bore $\varnothing$ 0.9mm thread M5x0.5		
<b>For models:</b>	1464812-02, 2063420-02, 2163422-02		

<b>bypass nozzles PEL22</b>			
			
<b>Part No.</b>	100281	<b>Ref. No.</b>	201143
<b>description</b>	bypass nozzle type PEL22 bore $\varnothing$ 0.4mm thread M6x0.5		
<b>For models:</b>	2063413-02, 2063414-03, 2063415-05, 2063416-02, 2063417-03, 2063418-05, 2063419-02, CGE11-L, CGE11-R, CGE61-L, CGE61-R, CSE11-L, CSE11-R, CSE61-L, CSE61-R		

			
<b>Part No.</b>	100392	<b>Ref. No.</b>	201169
<b>description</b>	bypass nozzle type PEL22 bore $\varnothing$ 0.6mm thread M6x0.5		
<b>For models:</b>	2063413-02, 2063414-03, 2063415-05, 2063416-02, 2063417-03, 2063418-05, 2063419-02, CPE63		


			
<b>Part No.</b>	100433	<b>Ref. No.</b>	201164
<b>description</b>	bypass nozzle type PEL22 bore $\varnothing$ 0.9mm thread M6x0.5		
<b>For models:</b>	1261301-02, 1261602-02, 1261602-03, 1261604-03, 1263405-01, 1361301-03, 1361602-01, 1361602-02, 1361604-02, 1363405-01, 1461602-00, 1463501-05, 2061301-01, 2061602-00, 2061602-01, 2061603-02, 2061604-01, 2063501-06, 2063502-10, 2063503-07, 3061602-00		





			
1			
<b>Part No.</b>	100407	<b>Ref. No.</b>	201166
<b>description</b>	bypass nozzle type PEL22 bore ø 1mm thread M6x0.5		
<b>For models:</b>	1261301-02, 1261602-02, 1261602-03, 1261604-03, 1361301-03, 1361602-01, 1361602-02, 1361604-02, 1461602-00, 2061301-01, 2061602-00, 2061602-01, 2061603-02, 2061604-01, 3061602-00		


internal nozzles


internal nozzles for EGA gas taps/nozzle holders


<b>EGA 24197/24362</b>			
			
1			
<b>Part No.</b>	100340	<b>Ref. No.</b>	201593
<b>description</b>	internal nozzle bore ø 0.85mm type EGA/PEL22		


			
1			
<b>Part No.</b>	100492	<b>Ref. No.</b>	201800
<b>description</b>	internal nozzle bore ø 0.8mm type EGA/PEL22		
<b>For models:</b>	0263401-00, 0263401-01		


			
1			
<b>Part No.</b>	100341	<b>Ref. No.</b>	201695
<b>description</b>	internal nozzle bore ø 1.15mm type EGA/PEL22		


			
1			
<b>Part No.</b>	100342	<b>Ref. No.</b>	201801
<b>description</b>	internal nozzle bore ø 1.4mm type EGA/PEL22		
<b>For models:</b>	2063413-02, 2063414-03, 2063415-05, 2063416-02, 2063417-03, 2063418-05, 2063419-02		


			
1			
<b>Part No.</b>	100345	<b>Ref. No.</b>	201803
<b>description</b>	internal nozzle bore ø 1.9mm type EGA/PEL22		
<b>For models:</b>	2063413-02, 2063414-03, 2063415-05, 2063416-02, 2063417-03, 2063418-05, 2063419-02		


			
1			
<b>Part No.</b>	100343	<b>Ref. No.</b>	201802
<b>description</b>	internal nozzle bore ø 1mm type EGA/PEL22		
<b>For models:</b>	14621011-0		


			
1			
<b>Part No.</b>	107502	<b>Ref. No.</b>	10013937
<b>description</b>	internal nozzle bore ø 2.7mm		

			
1			
<b>Part No.</b>	107501	<b>Ref. No.</b>	10013936
<b>description</b>	internal nozzle bore ø 2mm		

<b>EGA 26400/26440/23268</b>			
			
1			
<b>Part No.</b>	100311	<b>Ref. No.</b>	201834
<b>description</b>	internal nozzle bore ø 0.80mm suitable for EGA26400/26440		
<b>For models:</b>	1263401-00, 1263402-00, 1263402-01, 1263402-02, 1263404-00, 1263404-01, 1263404-02, 1263413-02, 1263414-02, 1363401-00, 1363402-00, 1363402-01, 1363402-02, 1363403-00, 1363403-01, 1363403-02, 1363403-03, 1363403-04, 1363403-05, 1363404-00, 1363404-01, 1363404-02, 1363404-03, 1363413-03, 1363415-05, 1464803-02, 1464803-03, 1464808-02, 1464808-03, 1464809-02, 1464809-03, 1464810-01, 1464810-02, 1464811-01, 1464811-02, 2063401-03, 2063401-04, 2063401-05, 2063401-06, 2063402-04, 2063402-05, 2063402-06, 2063403-07, 2063403-08, 2063403-09, 2063403-10, 2063404-04, 2063404-05, 2063404-06, 2063404-07... (Other models you can see in the webshop)		


			
1			
<b>Part No.</b>	100321	<b>Ref. No.</b>	201823
<b>description</b>	internal nozzle bore ø 0.90mm suitable for EGA26400/26440		
<b>For models:</b>	1263401-00, 1263402-00, 1263402-01, 1263402-02, 1263404-00, 1263404-01, 1263404-02, 1263413-02, 1263414-02, 1363401-00, 1363402-00, 1363402-01, 1363402-02, 1363403-00, 1363403-01, 1363403-02, 1363403-03, 1363403-04, 1363403-05, 1363404-00, 1363404-01, 1363404-02, 1363404-03, 1363413-03, 1363415-05, 1464803-02, 1464803-03, 1464808-02, 1464808-03, 1464809-02, 1464809-03, 1464810-01, 1464810-02, 1464811-01, 1464811-02, 2063401-03, 2063401-04, 2063401-05, 2063401-06, 2063402-04, 2063402-05, 2063402-06, 2063403-07, 2063403-08, 2063403-09, 2063403-10, 2063404-04, 2063404-05, 2063404-06, 2063404-07... (Other models you can see in the webshop)		


			
1			
<b>Part No.</b>	100312	<b>Ref. No.</b>	201839
<b>description</b>	internal nozzle bore ø 1.05mm suitable for EGA26400/26440		
<b>For models:</b>	1263402-00, 1263402-01, 1263402-02, 1263404-00, 1263404-01, 1263404-02, 1263413-02, 1263414-02, 1363402-00, 1363402-01, 1363402-02, 1363403-00, 1363403-01, 1363403-02, 1363403-03, 1363403-04, 1363403-05, 1363404-00, 1363404-01, 1363404-02, 1363404-03, 1363413-03, 1363415-05, 1464808-02, 1464808-03, 1464809-02, 1464809-03, 1464810-01, 1464810-02, 1464811-01, 1464811-02, 2063402-05, 2063402-06, 2063403-07, 2063403-08, 2063403-09, 2063403-10, 2063404-04, 2063404-05, 2063404-06, 2063404-07, 2063405-04, 2063405-05, 2063405-06, 2063406-07, 2063406-08, 2063406-09, 2063406-10, 2063407-04... (Other models you can see in the webshop)		


			
1			
<b>Part No.</b>	100313	<b>Ref. No.</b>	201697
<b>description</b>	internal nozzle bore ø 1.20mm suitable for EGA26400/26440		
<b>For models:</b>	1464803-02, 1464803-03, 1464808-02, 1464808-03, 1464809-02, 1464809-03, 2063401-03, 2063401-04, 2063401-05, 2063401-06, 2063402-04, 2063402-05, 2063402-06, 2063403-07, 2063403-08, 2063403-09, 2063403-10, 2063404-04, 2063404-05, 2063404-06, 2063404-07, 2063405-04, 2063405-05, 2063405-06, 2063406-07, 2063406-08, 2063406-09, 2063406-10, 2063407-04, 2063407-05, 2063407-06, 2063407-07, 3063401-02, 3063401-03, 3063401-04, 3063402-02, 3063402-03, 3063402-04, 3063405-02, 3063405-03, 3063405-04		









1 			
<b>Part No.</b>	107870	<b>Ref. No.</b>	201765
<b>description</b>	internal nozzle bore ø 1.25mm suitable for EGA26400/26440		
<b>For models:</b>	1263405-00, 1263405-01, 1363405-00, 1363405-01, 1464812-00, 1464812-01, 1464812-02, 2063420-00, 2063420-01, 2063420-02, 2163422-00, 2163422-01, 2163422-02		


1 			
<b>Part No.</b>	106510	<b>Ref. No.</b>	201770
<b>description</b>	internal nozzle bore ø 1.30mm suitable for EGA26400/26440		
<b>For models:</b>	1464803-02, 1464803-03, 1464808-02, 1464808-03, 1464809-02, 1464809-03, 2063401-03, 2063401-04, 2063401-05, 2063401-06, 2063402-04, 2063402-05, 2063402-06, 2063403-07, 2063403-08, 2063403-09, 2063403-10, 2063405-04, 2063405-05, 2063405-06, 2063406-07, 2063406-08, 2063406-09, 2063406-10, 3063401-02, 3063401-03, 3063401-04, 3063402-02, 3063402-03, 3063402-04, 3063405-02, 3063405-03, 3063405-04		


1 			
<b>Part No.</b>	100238	<b>Ref. No.</b>	201832
<b>description</b>	internal nozzle bore ø 1.35mm suitable for EGA 23268,26400,26440		
<b>For models:</b>	1263402-00, 1263402-01, 1263402-02, 1263404-00, 1263404-01, 1263404-02, 1263413-02, 1263414-02, 1363402-00, 1363402-01, 1363402-02, 1363403-00, 1363403-01, 1363403-02, 1363403-03, 1363403-04, 1363403-05, 1363404-00, 1363404-01, 1363404-02, 1363404-03, 1363413-03, 1363415-05, 1464803-02, 1464803-03, 1464808-02, 1464808-03, 1464809-02, 1464809-03, 1464810-01, 1464810-02, 1464811-01, 1464811-02, 2063401-03, 2063401-04, 2063401-05, 2063401-06, 2063402-04, 2063402-05, 2063402-06, 2063403-07, 2063403-08, 2063403-09, 2063403-10, 2063404-04, 2063404-05, 2063404-06, 2063404-07, 2063405-04, 2063405-05... (Other models you can see in the webshop)		


1 			
<b>Part No.</b>	106480	<b>Ref. No.</b>	201824
<b>description</b>	internal nozzle bore ø 1.5mm suitable for EGA26400/26440		
<b>For models:</b>	1263401-00, 1263402-00, 1263402-01, 1263404-00, 1263404-01, 1363401-00, 1363402-00, 1363402-01, 1363403-00, 1363403-01, 1363403-02, 1363403-03, 1363403-04, 1363404-00, 1363404-01, 1363404-02, 1464803-02, 1464808-02, 1464809-02, 1464810-01, 1464811-01, 2063401-03, 2063401-04, 2063401-05, 2063402-04, 2063402-05, 2063403-07, 2063403-08, 2063403-09, 2063404-04, 2063404-05, 2063404-06, 2063405-04, 2063405-05, 2063406-07, 2063406-08, 2063406-09, 2063407-04, 2063407-05, 2063407-06, 2163401-02, 2163401-03, 2163401-04, 2163402-03, 2163402-04, 2163403-06, 2163403-07, 2163403-08, 2163404-03, 2163404-04... (Other models you can see in the webshop)		


1 			
<b>Part No.</b>	100951	<b>Ref. No.</b>	10016562
<b>description</b>	internal nozzle bore ø 1.75mm suitable for EGA26400/26440		
<b>accessories for</b>	100951		
	<b>Part No.</b>	100927	<b>Ref. No.</b> —
	torsion spring L 2.8-8.0mm for internal nozzle ø 3mm bore ømm		

1 			
<b>Part No.</b>	100244	<b>Ref. No.</b>	201837
<b>description</b>	internal nozzle bore ø 1.85mm suitable for EGA 23268,26400,26440		
<b>For models:</b>	1263402-00, 1263402-01, 1263402-02, 1263404-00, 1263404-01, 1263404-02, 1263413-02, 1263414-02, 1363402-00, 1363402-01, 1363402-02, 1363403-00, 1363403-01, 1363403-02, 1363403-03, 1363403-04, 1363403-05, 1363404-00, 1363404-01, 1363404-02, 1363404-03, 1363413-03, 1363415-05, 1464808-02, 1464808-03, 1464809-02, 1464809-03, 1464810-01, 1464810-02, 1464811-01, 1464811-02, 2063402-04, 2063402-05, 2063402-06, 2063403-07, 2063403-08, 2063403-09, 2063403-10, 2063404-04, 2063404-05, 2063404-06, 2063404-07, 2063405-04, 2063405-05, 2063405-06, 2063406-07, 2063406-08, 2063406-09, 2063406-10, 2063407-04... (Other models you can see in the webshop)		

1 			
<b>Part No.</b>	100314	<b>Ref. No.</b>	10016563
<b>description</b>	internal nozzle bore ø 1.90mm suitable for EGA26400/26440		

1 			
<b>Part No.</b>	100274	<b>Ref. No.</b>	201694
<b>description</b>	internal nozzle bore ø 2.00mm suitable for EGA26400/26440		
<b>For models:</b>	1263402-00, 1263402-01, 1263404-00, 1263404-01, 1363402-00, 1363402-01, 1363403-00, 1363403-01, 1363403-02, 1363403-03, 1363403-04, 1363404-00, 1363404-01, 1363404-02, 1464803-02, 1464803-03, 1464808-02, 1464808-03, 1464809-02, 1464809-03, 1464810-01, 1464811-01, 1464812-02, 2063401-03, 2063401-04, 2063401-05, 2063401-06, 2063402-04, 2063402-05, 2063402-06, 2063403-07, 2063403-08, 2063403-09, 2063403-10, 2063404-04, 2063404-05, 2063404-06, 2063404-07, 2063405-04, 2063405-05, 2063405-06, 2063406-07, 2063406-08, 2063406-09, 2063406-10, 2063407-04, 2063407-05, 2063407-06, 2063407-07, 2063413-02... (Other models you can see in the webshop)		

1 			
<b>Part No.</b>	100317	<b>Ref. No.</b>	201771
<b>description</b>	internal nozzle bore ø 2.20mm suitable for EGA26400/26440		
<b>For models:</b>	1263405-00, 1263405-01, 1363405-00, 1363405-01, 1464803-02, 1464808-02, 1464809-02, 1464812-00, 1464812-01, 2063401-03, 2063401-04, 2063401-05, 2063402-04, 2063402-05, 2063403-07, 2063403-08, 2063403-09, 2063404-04, 2063404-05, 2063404-06, 2063405-04, 2063405-05, 2063406-07, 2063406-08, 2063406-09, 2063407-04, 2063407-05, 2063407-06, 2063420-00, 2063420-01, 2063420-02, 2163422-00, 2163422-01, 2163422-02, 3063401-02, 3063401-03, 3063402-02, 3063402-03, 3063405-02, 3063405-03		

1 			
<b>Part No.</b>	100678	<b>Ref. No.</b>	10016564
<b>description</b>	internal nozzle bore ø 2.50mm suitable for EGA26400/26440		



## auxiliary gas parts

### screw connections



#### test nipple screws




<b>Part No.</b>	102762	<b>Ref. No.</b>	205268
<b>description</b>	locking screw with test nipple thread 3/8" WS 17		
<b>For models:</b>	1261101-00, 1261101-01, 1261101-02, 1261102-00, 1261102-01, 1261102-02, 1361101-00, 1361101-01, 1361101-02, 1361101-03, 1361102-00, 1361102-01, 1361102-02, 1361102-03, 1461101-01, 1461101-02, 1461101-03, 1461102-01, 1461102-02, 1461102-03, 1461104-01, 1461104-02, 1461104-03, 1461105-01, 1461105-02, 1461105-03, 1461109-01, 1461109-02, 1461109A01, 1461109A02, 1462802B00, 1462804B00, 1463501-02, 1463501-03, 1463501-04, 1463501-05, 1561110-00, 2061101-01, 2061101-02, 2061101-03, 2061101-04, 2061101-05, 2061102-01, 2061102-02, 2061102-03, 2061102-04, 2061102-05, 2061103-04, 2061107-00, 2061107-01... (Other models you can see in the webshop)		
<b>accessories for</b>	102762		





#### olives





<b>Part No.</b>	101273	<b>Ref. No.</b>	201594
<b>description</b>	olive for pipe ø 12mm L 9.5mm brass Qty 1 pcs suitable for universal		
<b>For models:</b>	1422802B04, 1422802B05, 1422802B06, 1422802B07, 1422802B08, 1422804B04, 1422804B05, 1422804B06, 1422804B07, 1422804B08, 1422805B04, 1422805B05, 1422805B06, 1422805B07, 1422805B08, 1462802B00, 1462802B01, 1462802B02, 1462802B03, 1462802B04, 1462802B05, 1462804B00, 1462804B01, 1462804B02, 1462804B03, 1462804B04, 1462804B05, 1462831-00, 1462832-00, 1462833-00, 1462834-00, 1462835-00, 1462836-00, 1462837-00, 1462838-00, 1462839-00, 1462840-00, 1462908-00, 1462910-00, 2022802B04, 2022802B05, 2022802B06, 2022802B07, 2022802B08, 2022802B09, 2022802B10, 2022802C07, 2022802C08, 2022802C09, 2022802C10... (Other models you can see in the webshop)		
<b>accessories for</b>	101273		
	<b>Part No.</b>	100944	<b>Ref. No.</b> —
	union nut thread M18x1.5 for pipe ø 12mm		
	<b>Part No.</b>	101276	<b>Ref. No.</b> —
	union screw thread 3/8" tube ø 12mm Qty 1 pcs		



<b>Part No.</b>	101281	<b>Ref. No.</b>	201560
<b>description</b>	olive for pipe ø 4mm L 8.7mm Qty 1 pcs suitable for CB 502/503		
<b>For models:</b>	0260301-00, 0260301-01, 0260302-00, 0260302-01, 0260501-00, 0261101-00, 0261101-01, 0261102-00, 0261102-01, 0261103-00, 0261103-01, 0261301-00, 0261601-00, 1261601-01, 1261602-00, 1261602-01, 1261602-02, 1261602-03, 1261604-03, 1361601-01, 1361601-02, 1361602-00, 1361602-01, 1361602-02, 1361604-02, 1460302-00, 1461101-00, 1461102-00, 1461103-00, 1461602-00, 1462101-00, 1462101-01, 1462101-02, 1462101-03, 1462101-04, 1462101-10, 1462102-00, 1462102-00_V2, 1462102-01, 1463501-02, 1463501-03, 1463501-04, 1463501-05, 2060301-00, 2060501-00, 2060501-01, 2060501-10, 2061101-00, 2061101-10, 2061102-00... (Other models you can see in the webshop)		
<b>accessories for</b>	101281		
	<b>Part No.</b>	101283	<b>Ref. No.</b> 201692
	union screw thread M10x1 for pipe ø 4mm Qty 1 pcs		

	<b>Part No.</b>	101284	<b>Ref. No.</b>	201827
<b>description</b>	olive for pipe ø 4mm Qty 1 pcs			
<b>For models:</b>	1261601-01, 1261602-00, 1261602-01, 1261602-02, 1261602-03, 1261604-03, 1361601-01, 1361601-02, 1361602-00, 1361602-01, 1361602-02, 1361604-02			
<b>accessories for</b>	101284			
	<b>Part No.</b>	101259	<b>Ref. No.</b>	—
	union nut thread M8x1 for pipe ø 4mm			
	<b>Part No.</b>	101285	<b>Ref. No.</b>	—
	union screw thread M8x1 for pipe ø 4mm Qty 1 pcs JUNKERS			
	<b>Part No.</b>	101294	<b>Ref. No.</b>	—
	union nut thread M10x1 for pipe ø 4mm WS 14 L 12mm Qty 1 pcs			

	<b>Part No.</b>	100870	<b>Ref. No.</b>	201696
<b>description</b>	olive for pipe ø 4mm Qty 1 pcs suitable for 160 series for pilot burner			

	<b>Part No.</b>	101879	<b>Ref. No.</b>	201828
<b>description</b>	olive for pipe ø 5mm Qty 1 pcs			
<b>For models:</b>	0260301-01, 0260302-01, 1260301-00, 1260301-01, 1260302-00, 1260302-01, 1460302-00, 1460302-01, 1460302-02, 2060301-00, 2060301-01, 2060301-02			


	<b>Part No.</b>	101286	<b>Ref. No.</b>	201571
<b>description</b>	olive ID ø 6mm Qty 1 pcs			
<b>For models:</b>	0260301-00, 0260301-01, 0260302-00, 0260302-01, 1260301-00, 1260301-01, 1260302-00, 1260302-01, 1412831-00, 1412832-00, 1412833-00, 1412833-01, 1412834-00, 1412834-01, 1412908-00, 1412910-00, 1412910-01, 1422802B04, 1422802B05, 1422802B06, 1422802B07, 1422802B08, 1422804B04, 1422804B05, 1422804B06, 1422804B07, 1422804B08, 1422805B04, 1422805B05, 1422805B06, 1422805B07, 1422805B08, 1422807B00, 1422807B01, 1422807B02, 1422807B03, 1422807B04, 1422831-00, 1422832-00, 1422833-00, 1422834-00, 1422902-00, 1422902-01, 1422902-02, 1422902-03, 1422902-04, 1422908-00, 1422910-00, 1423901-00, 1423901-01... (Other models you can see in the webshop)			
<b>accessories for</b>	101286			
	<b>Part No.</b>	100909	<b>Ref. No.</b>	—
	union screw thread M10x1 for pipe ø 6mm Qty 1 pcs			
	<b>Part No.</b>	101464	<b>Ref. No.</b>	—
	union nut thread M12x1 for pipe ø 6mm			



## union nuts



1

Part No.	101300	Ref. No.	021513	
description	union nut thread M16x1.5 tube ø 10mm			
accessories for	101300			
	Part No.	101278	Ref. No.	—
	olive for pipe ø 10mm Qty 1 pcs			

## union screws




1

Part No.	100906	Ref. No.	201693
description	screw connection thread M10x1 for ignition electrode brass Qty 1 pcs WS 10		



1

Part No.	101283	Ref. No.	201692	
description	union screw thread M10x1 for pipe ø 4mm Qty 1 pcs			
accessories for	101283			
	Part No.	101282	Ref. No.	—
	olive for pipe ø 4mm L 7.4mm Qty 1 pcs			



1

Part No.	101878	Ref. No.	945054
description	union screw thread M10x1 for pipe ø 5mm Qty 1 pcs for ignition gas pipe		

## locking screws



1

Part No.	102761	Ref. No.	205267
description	locking screw thread 3/8" WS 17		
For models:	1261101-00, 1261101-01, 1261101-02, 1261102-00, 1261102-01, 1261102-02, 1361101-00, 1361101-01, 1361101-02, 1361101-03, 1361102-00, 1361102-01, 1361102-02, 1361102-03, 1461101-01, 1461101-02, 1461101-03, 1461102-01, 1461102-02, 1461102-03, 1461104-01, 1461104-02, 1461104-03, 1461105-01, 1461105-02, 1461105-03, 1461109-01, 1461109-02, 1461109A01, 1461109A02, 1462802B00, 1462804B00, 1463501-03, 1463501-04, 1463501-05, 1561110-00, 2061101-01, 2061101-02, 2061101-03, 2061101-04, 2061101-05, 2061102-01, 2061102-02, 2061102-03, 2061102-04, 2061102-05, 2061103-04, 2061107-00, 2061107-01, 2061107-02... (Other models you can see in the webshop)		



1

Part No.	102762	Ref. No.	205268
description	locking screw with test nipple thread 3/8" WS 17		
For models:	1261101-00, 1261101-01, 1261101-02, 1261102-00, 1261102-01, 1261102-02, 1361101-00, 1361101-01, 1361101-02, 1361101-03, 1361102-00, 1361102-01, 1361102-02, 1361102-03, 1461101-01, 1461101-02, 1461101-03, 1461102-01, 1461102-02, 1461102-03, 1461104-01, 1461104-02, 1461104-03, 1461105-01, 1461105-02, 1461105-03, 1461109-01, 1461109-02, 1461109A01, 1461109A02, 1462802B00, 1462804B00, 1463501-02, 1463501-03, 1463501-04, 1463501-05, 1561110-00, 2061101-01, 2061101-02, 2061101-03, 2061101-04, 2061101-05, 2061102-01, 2061102-02, 2061102-03, 2061102-04, 2061102-05, 2061103-04, 2061107-00, 2061107-01... (Other models you can see in the webshop)		

## gas ball valves

with DIN-DVGW approval



1

Part No.	520508	Ref. No.	201159+203813 201752 845951
description	gas ball valve straight inlet 3/4" IT outlet 3/4" IT DN20 L 109mm approval DIN-DVGW gas		
For models:	1462802B00, 1462802B01, 1462804B00, 1462804B01, 1464812-00, 1464812-01, 2061401-02, 2061401-03, 2061401-04, 2061401-05, 2061401-06, 2061401A01, 2061401A02, 2061401A03, 2061401A05, 2061401A06, 2061401B01, 2061401B02, 2061401B03, 2061401B05, 2061401B06, 2061401C01, 2061401C02, 2061401C03, 2061401C05, 2061401C06, 2061402-02, 2061402-03, 2061402-04, 2061402-05, 2061402-06, 2061402A01, 2061402A02, 2061402A03, 2061402A05, 2061402A06, 2061402B01, 2061402B02, 2061402B03, 2061402B05, 2061402B06, 2061402C01, 2061402C02, 2061402C03, 2061402C05, 2061402C06, 2061403-00, 2061403-01, 2061403-02, 2061403-03... (Other models you can see in the webshop)		

## consumables

lava rocks / ceramic briquetts



1

Part No.	211100	Ref. No.	201517
description	ceramic briquetts size 53x53x24		
For models:	0261601-00, 1261601-00, 1261601-01, 1261602-00, 1261602-01, 1261602-02, 1261602-03, 1261604-03, 1361601-00, 1361601-01, 1361601-02, 1361602-00, 1361602-01, 1361602-02, 1361604-02, 1461601-00, 1461602-00, 2061602-00, 2061602-01, 2061603-00, 2061603-01, 2061603-02, 2061604-01, 3061602-00		



## equipment-specific units

### for griddles

#### spare parts and accessories




<b>Part No.</b>	692883	<b>Ref. No.</b>	203898
<b>description</b>	distance washers for griddle ø 14mm L 25.5mm stainless steel		

### for convection ovens/combi-steamers

#### drain units

##### drip rails



<b>Part No.</b>	692765	<b>Ref. No.</b>	202125
<b>description</b>	drip rail L 620mm plastic with support plate W 38mm hole ø 5mm for combi-steamer		
<b>For models:</b>	CSE11-R, CSE11-R-DG, CSE12-R, CSE12-R-DG, CSE61-R, CSE61-R-DG, CSE62-R, CSE62-R-DG, CSG11-R-DG, CSG12-R-DG, CSG61-R, CSG61-R-DG, CSG62-R, CSG62-R-DG		
<b>spare parts for</b>	692765		
	<b>Part No.</b>	696808	<b>Ref. No.</b>
			204615
	support bracket zinc-plated sheet steel		



<b>Part No.</b>	694975	<b>Ref. No.</b>	10013386
<b>description</b>	drip rail L 630mm plastic		

#### accessories



<b>Part No.</b>	696808	<b>Ref. No.</b>	204615
<b>description</b>	support bracket zinc-plated sheet steel		
<b>For models:</b>	CGE11-L, CGE11-R, CGE12-L, CGE12-R, CGE61-L, CGE61-R, CGE62-L, CGE62-R, CGG11-L, CGG11-R, CGG12-L, CGG12-R, CGG61-L, CGG61-R, CGG62-L, CGG62-R, CSE11-L, CSE11-R, CSE11-R-DG, CSE12-L, CSE12-R, CSE12-R-DG, CSE61-L, CSE61-R, CSE61-R-DG, CSE62-L, CSE62-R, CSE62-R-DG, CSG11-L, CSG11-R, CSG11-R-DG, CSG12-L, CSG12-R, CSG12-R-DG, CSG61-L, CSG61-R, CSG61-R-DG, CSG62-L, CSG62-R, CSG62-R-DG		



<b>Part No.</b>	696814	<b>Ref. No.</b>	204416
<b>description</b>	support bracket zinc-plated sheet steel		
<b>For models:</b>	CGE11-L, CGE11-R, CGE12-L, CGE12-R, CGE21-L, CGE21-R, CGE22-L, CGE22-R, CGE61-L, CGE61-R, CGE62-L, CGE62-R, CGG11-L, CGG11-R, CGG12-L, CGG12-R, CGG61-L, CGG61-R, CGG62-L, CGG62-R, CSE11-L, CSE11-R, CSE12-L, CSE12-R, CSE21-L, CSE21-R, CSE22-L, CSE22-R, CSE61-L, CSE61-R, CSE62-L, CSE62-R, CSG11-L, CSG11-R, CSG12-L, CSG12-R, CSG61-L, CSG61-R, CSG62-L, CSG62-R		





<b>Part No.</b>	696812	<b>Ref. No.</b>	205309
<b>description</b>	bush ID ø 10mm L 15mm WS 19 thread ø M16x1mm		
<b>For models:</b>	CGG11-L, CGG11-R, CGG12-L, CGG12-R, CGG21-L, CGG21-R, CGG22-L, CGG22-R, CGG61-L, CGG61-R, CGG62-L, CGG62-R, CSG11-L, CSG11-R, CSG11-R-DG, CSG12-L, CSG12-R, CSG12-R-DG, CSG21-L, CSG21-R, CSG21-R-DG, CSG22-L, CSG22-R, CSG22-R-DG, CSG61-L, CSG61-R, CSG61-R-DG, CSG62-L, CSG62-R, CSG62-R-DG		




<b>Part No.</b>	696813	<b>Ref. No.</b>	204057
<b>description</b>	bush ID ø 12mm ED ø 14mm L 10mm		
<b>For models:</b>	CGE11-L, CGE11-R, CGE12-L, CGE12-R, CGE21-L, CGE21-R, CGE22-L, CGE22-R, CGE61-L, CGE61-R, CGE62-L, CGE62-R, CGG11-L, CGG11-R, CGG12-L, CGG12-R, CGG21-L, CGG21-R, CGG22-L, CGG22-R, CGG61-L, CGG61-R, CGG62-L, CGG62-R, CSE11-L, CSE11-R, CSE11-R-DG, CSE12-L, CSE12-R, CSE12-R-DG, CSE21-L, CSE21-R, CSE21-R-DG, CSE22-L, CSE22-R, CSE22-R-DG, CSE61-L, CSE61-R, CSE61-R-DG, CSE62-L, CSE62-R, CSE62-R-DG, CSG11-L, CSG11-R, CSG11-R-DG, CSG12-L, CSG12-R, CSG12-R-DG, CSG21-L, CSG21-R...(Other models you can see in the webshop)		





			
1			
<b>Part No.</b>	551451	<b>Ref. No.</b>	203820
<b>description</b>	spacer bush ID ø 2.5mm ED ø 9.5mm L 15mm plastic		
<b>For models:</b>	CCE60, CCE63, CGE11-L, CGE11-R, CGE12-L, CGE12-R, CGE21-L, CGE21-R, CGE22-L, CGE22-R, CGE61-L, CGE61-R, CGE62-L, CGE62-R, CGG11-L, CGG11-R, CGG12-L, CGG12-R, CGG21-L, CGG21-R, CGG22-L, CGG22-R, CGG61-L, CGG61-R, CGG62-L, CGG62-R, CPE60, CPE63, CSE11-L, CSE11-R, CSE11-R-DG, CSE12-L, CSE12-R, CSE12-R-DG, CSE21-L, CSE21-R, CSE21-R-DG, CSE22-L, CSE22-R, CSE22-R-DG, CSE61-L, CSE61-R, CSE61-R-DG, CSE62-L, CSE62-R, CSE62-R-DG, CSG11-L, CSG11-R, CSG11-R-DG, CSG12-L...(Other models you can see in the webshop)		

			
1			
<b>Part No.</b>	696810	<b>Ref. No.</b>	203899
<b>description</b>	spacer bush ID ø 4.5mm ED ø 10mm L 8.5mm		

			
1			
<b>Part No.</b>	696803	<b>Ref. No.</b>	203897
<b>description</b>	spacer bush ID ø 6.2mm ED ø 10mm L 3mm stainless steel		

injection pipes

			
1			
<b>Part No.</b>	692826	<b>Ref. No.</b>	935545
<b>description</b>	supply tube for combi-steamer water inlet pipe connection 10/13 1/2" / 3/4"		
<b>For models:</b>	CGG11-L, CGG11-R, CGG12-L, CGG12-R, CGG21-L, CGG21-R, CGG22-L, CGG22-R, CSG11-L, CSG11-R, CSG11-R-DG, CSG12-L, CSG12-R, CSG12-R-DG, CSG21-L, CSG21-R, CSG21-R-DG, CSG22-L, CSG22-R, CSG22-R-DG		


			
1			
<b>Part No.</b>	692825	<b>Ref. No.</b>	10011101
<b>description</b>	water pipe for combi-steamer ED ø 10mm ID ø 8mm		
<b>For models:</b>	CGE11-L, CGE11-R, CGE12-L, CGE12-R, CGE21-L, CGE21-R, CGE22-L, CGE22-R, CGE61-L, CGE61-R, CGE62-L, CGE62-R, CGG11-L, CGG11-R, CGG12-L, CGG12-R, CGG21-L, CGG21-R, CGG22-L, CGG22-R, CGG61-L, CGG61-R, CGG62-L, CGG62-R, CSE11-L, CSE11-R, CSE11-R-DG, CSE12-L, CSE12-R, CSE12-R-DG, CSE61-L, CSE61-R, CSE61-R-DG, CSE62-L, CSE62-R, CSE62-R-DG, CSG11-L, CSG11-R, CSG11-R-DG, CSG12-L, CSG12-R, CSG12-R-DG, CSG21-L, CSG21-R, CSG21-R-DG, CSG22-L, CSG22-R, CSG22-R-DG, CSG61-L, CSG61-R...(Other models you can see in the webshop)		
<b>accessories for</b>	692825		
	<b>Part No.</b>	699481	<b>Ref. No.</b> 10011098
	gasket suitable for MKN combi-steamer L 58mm W 22mm ID ø 13mm graphite thickness 1.5mm		

			
1			
<b>Part No.</b>	692823	<b>Ref. No.</b>	204580
<b>description</b>	water pipe for combi-steamer ED ø 15mm ID ø 12mm		
<b>For models:</b>	CGE21-L, CGE21-R, CGE22-L, CGE22-R, CGG21-L, CGG21-R, CGG22-L, CGG22-R, CSE21-L, CSE21-R, CSE21-R-DG, CSE22-L, CSE22-R, CSE22-R-DG, CSG21-L, CSG21-R, CSG21-R-DG, CSG22-L, CSG22-R, CSG22-R-DG		


			
1			
<b>Part No.</b>	692824	<b>Ref. No.</b>	935550
<b>description</b>	water pipe for combi-steamer ED ø 15mm ID ø 12mm		
<b>For models:</b>	CGG61-L, CGG61-R, CGG62-L, CGG62-R, CSG61-L, CSG61-R, CSG61-R-DG, CSG62-L, CSG62-R, CSG62-R-DG		

			
1			
<b>Part No.</b>	692822	<b>Ref. No.</b>	204430
<b>description</b>	water pipe for fan wheel for combi-steamer ED ø 15mm ID ø 12mm HD6.x-HD20.x		
<b>For models:</b>	CGE11-L, CGE11-R, CGE12-L, CGE12-R, CGE21-L, CGE21-R, CGE22-L, CGE22-R, CGE61-L, CGE61-R, CGE62-L, CGE62-R, CSE11-L, CSE11-R, CSE11-R-DG, CSE12-L, CSE12-R, CSE12-R-DG, CSE21-L, CSE21-R, CSE21-R-DG, CSE22-L, CSE22-R, CSE22-R-DG, CSE61-L, CSE61-R, CSE61-R-DG, CSE62-L, CSE62-R, CSE62-R-DG		

spare parts and accessories

			
1			
<b>Part No.</b>	699338	<b>Ref. No.</b>	202726
<b>description</b>	battery Lithium H 8mm ø 24.5mm 3V CR2477N		
<b>For models:</b>	CCE60, CCE63, CPE60, CPE63		





<b>Part No.</b>	696807	<b>Ref. No.</b>	204429
<b>description</b>	bracket for cartridge ø 45mm		
<b>For models:</b>	CCE60, CCE63, CGE11-L, CGE11-R, CGE12-L, CGE12-R, CGE21-L, CGE21-R, CGE22-L, CGE22-R, CGE61-L, CGE61-R, CGE62-L, CGE62-R, CGG11-L, CGG11-R, CGG12-L, CGG12-R, CGG21-L, CGG21-R, CGG22-L, CGG22-R, CGG61-L, CGG61-R, CGG62-L, CGG62-R, CPE60, CPE63, CSE11-L, CSE11-R, CSE11-R-DG, CSE12-L, CSE12-R, CSE12-R-DG, CSE61-L, CSE61-R, CSE61-R-DG, CSE62-L, CSE62-R, CSE62-R-DG, CSG11-L, CSG11-R, CSG11-R-DG, CSG12-L, CSG12-R, CSG12-R-DG, CSG61-L, CSG61-R, CSG61-R-DG, CSG62-L, CSG62-R, CSG62-R-DG		




<b>Part No.</b>	850129	<b>Ref. No.</b>	055101
<b>description</b>	insulating mat for combi-steamer L 490mm W 320mm H 15mm cut-out 80x100mm		



<b>Part No.</b>	542435	<b>Ref. No.</b>	201170
<b>description</b>	cover H 25mm ø 57mm		
<b>For models:</b>	CGE11-L, CGE11-R, CGE12-L, CGE12-R, CGE21-L, CGE21-R, CGE22-L, CGE22-R, CGE61-L, CGE61-R, CGE62-L, CGE62-R, CGG11-L, CGG11-R, CGG12-L, CGG12-R, CGG21-L, CGG21-R, CGG22-L, CGG22-R, CGG61-L, CGG61-R, CGG62-L, CGG62-R, CSE11-L, CSE11-R, CSE11-R-DG, CSE12-L, CSE12-R, CSE12-R-DG, CSE21-L, CSE21-R, CSE21-R-DG, CSE22-L, CSE22-R, CSE22-R-DG, CSE61-L, CSE61-R, CSE61-R-DG, CSE62-L, CSE62-R, CSE62-R-DG, CSG11-L, CSG11-R, CSG11-R-DG, CSG12-L, CSG12-R, CSG12-R-DG, CSG21-L, CSG21-R...(Other models you can see in the webshop)		




<b>Part No.</b>	696802	<b>Ref. No.</b>	203724
<b>description</b>	spacer for PCB H 10.5mm plastic ball port ø 3.3mm		
<b>For models:</b>	CGE11-L, CGE11-R, CGE12-L, CGE12-R, CGE21-L, CGE21-R, CGE22-L, CGE22-R, CGE61-L, CGE61-R, CGE62-L, CGE62-R, CGG11-L, CGG11-R, CGG12-L, CGG12-R, CGG21-L, CGG21-R, CGG22-L, CGG22-R, CGG61-L, CGG61-R, CGG62-L, CGG62-R, CPE60, CPE63, CSE11-L, CSE11-R, CSE12-L, CSE12-R, CSE21-L, CSE21-R, CSE22-L, CSE22-R, CSE61-L, CSE61-R, CSE62-L, CSE62-R, CSG11-L, CSG11-R, CSG12-L, CSG12-R, CSG21-L, CSG21-R, CSG22-L, CSG22-R, CSG61-L, CSG61-R, CSG62-L, CSG62-R		




<b>Part No.</b>	696804	<b>Ref. No.</b>	203681
<b>description</b>	cover cap L 39mm ø 12mm ID ø 9.6mm		
<b>For models:</b>	CCE60, CCE63, CGE11-L, CGE11-R, CGE12-L, CGE12-R, CGE21-L, CGE21-R, CGE22-L, CGE22-R, CGE61-L, CGE61-R, CGE62-L, CGE62-R, CGG11-L, CGG11-R, CGG12-L, CGG12-R, CGG21-L, CGG21-R, CGG22-L, CGG22-R, CGG61-L, CGG61-R, CGG62-L, CGG62-R, CPE60, CPE63, CSE11-L, CSE11-R, CSE11-R-DG, CSE12-L, CSE12-R, CSE12-R-DG, CSE21-L, CSE21-R, CSE21-R-DG, CSE22-L, CSE22-R, CSE22-R-DG, CSE61-L, CSE61-R, CSE61-R-DG, CSE62-L, CSE62-R, CSE62-R-DG, CSG11-L, CSG11-R, CSG11-R-DG, CSG12-L, CSG12-R, CSG12-R-DG, CSG21-L, CSG21-R...(Other models you can see in the webshop)		

### filters




<b>Part No.</b>	692893	<b>Ref. No.</b>	201134
<b>description</b>	screen H 14mm ø 19.5mm plastic		
<b>For models:</b>	1422807B03, 1422807B04, 1422831-00, 1422832-00, 1422833-00, 1422834-00, 1422902-03, 1422902-04, 1422908-00, 1422910-00, 1423901-00, 1423901-01, 1423901-02, 1423902-00, 1423902-01, 1423902-02, 1423903-00, 1423903-01, 1423903-02, 1462831-00, 1462832-00, 1462833-00, 1462834-00, 1462835-00, 1462836-00, 1462837-00, 1462838-00, 1462839-00, 1462840-00, 1462908-00, 1462910-00, 2022802B08, 2022802B09, 2022802B10, 2022802C08, 2022802C09, 2022802C10, 2022802D00, 2022802D01, 2022802D02, 2022804B08, 2022804B09, 2022804B10, 2022804C08, 2022804C09, 2022804C10, 2022804D00, 2022804D01, 2022804D02, 2022805B08...(Other models you can see in the webshop)		




<b>Part No.</b>	551449	<b>Ref. No.</b>	202755
<b>description</b>	distance washers L 20mm ø 17.5mm plastic		
<b>For models:</b>	CCE60, CCE63, CPE60, CPE63		

### housing and bezels




<b>Part No.</b>	694972	<b>Ref. No.</b>	866789
<b>description</b>	bracket L 52mm W 28mm H 115mm		
<b>For models:</b>	CCE60, CCE63, CGE11-L, CGE11-R, CGE12-L, CGE12-R, CGE21-L, CGE21-R, CGE22-L, CGE22-R, CGE61-L, CGE61-R, CGE62-L, CGE62-R, CGG11-L, CGG11-R, CGG12-L, CGG12-R, CGG21-L, CGG21-R, CGG22-L, CGG22-R, CGG61-L, CGG61-R, CGG62-L, CGG62-R, CPE60, CPE63, CSE11-L, CSE11-R, CSE11-R-DG, CSE12-L, CSE12-R, CSE12-R-DG, CSE21-L, CSE21-R, CSE21-R-DG, CSE22-L, CSE22-R, CSE22-R-DG, CSE61-L, CSE61-R, CSE61-R-DG, CSE62-L, CSE62-R, CSE62-R-DG, CSG11-L, CSG11-R, CSG11-R-DG, CSG12-L...(Other models you can see in the webshop)		




			
1			
<b>Part No.</b>	699337	<b>Ref. No.</b>	202782
<b>description</b>	cover cap for USB L 38mm W 29mm		
<b>For models:</b>	CGE11-L, CGE11-R, CGE12-L, CGE12-R, CGE21-L, CGE21-R, CGE22-L, CGE22-R, CGE61-L, CGE61-R, CGE62-L, CGE62-R, CGG11-L, CGG11-R, CGG12-L, CGG12-R, CGG21-L, CGG21-R, CGG22-L, CGG22-R, CGG61-L, CGG61-R, CGG62-L, CGG62-R, CPE60, CPE63		


## cleaning system

## nozzles


			
1			
<b>Part No.</b>	694665	<b>Ref. No.</b>	201146
<b>description</b>	nozzle thread 1/4" ET H 57mm for cleaning system		
<b>For models:</b>	CGE11-L, CGE11-R, CGE12-L, CGE12-R, CGE21-L, CGE21-R, CGE22-L, CGE22-R, CGE61-L, CGE61-R, CGE62-L, CGE62-R, CSE11-L, CSE11-R, CSE12-L, CSE12-R, CSE21-L, CSE21-R, CSE22-L, CSE22-R, CSE61-L, CSE61-R, CSE62-L, CSE62-R		

			
1			
<b>Part No.</b>	694664	<b>Ref. No.</b>	201152
<b>description</b>	nozzle thread 1/4" ET WS 17 H 37mm for cleaning system		
<b>For models:</b>	CPE63		

## screw connections

			
1			
<b>Part No.</b>	362008	<b>Ref. No.</b>	205293
<b>description</b>	connecting piece 1/2" -3/4" L 100,5mm plastic		
<b>For models:</b>	CGE11-L, CGE11-R, CGE12-L, CGE12-R, CGE21-L, CGE21-R, CGE22-L, CGE22-R, CGE61-L, CGE61-R, CGE62-L, CGE62-R, CGG11-L, CGG11-R, CGG12-L, CGG12-R, CGG21-L, CGG21-R, CGG22-L, CGG22-R, CGG61-L, CGG61-R, CGG62-L, CGG62-R, CSE11-L, CSE11-R, CSE11-R-DG, CSE12-L, CSE12-R, CSE12-R-DG, CSE21-L, CSE21-R, CSE21-R-DG, CSE22-L, CSE22-R, CSE22-R-DG, CSE61-L, CSE61-R, CSE61-R-DG, CSE62-L, CSE62-R, CSE62-R-DG, CSG11-L, CSG11-R, CSG11-R-DG, CSG12-L, CSG12-R, CSG12-R-DG, CSG21-L, CSG21-R...(Other models you can see in the webshop)		

## service kits

			
1			
<b>Part No.</b>	381514	<b>Ref. No.</b>	205183
<b>description</b>	screw connection kit for temperature probe		
<b>For models:</b>	CGE11-L, CGE11-R, CGE12-L, CGE12-R, CGE21-L, CGE21-R, CGE22-L, CGE22-R, CGE61-L, CGE61-R, CGE62-L, CGE62-R, CGG11-L, CGG11-R, CGG12-L, CGG12-R, CGG21-L, CGG21-R, CGG22-L, CGG22-R, CGG61-L, CGG61-R, CGG62-L, CGG62-R, CPE63, CSE11-L, CSE11-R, CSE12-L, CSE12-R, CSE21-L, CSE21-R, CSE21-R-DG, CSE22-L, CSE22-R, CSE22-R-DG, CSE61-L, CSE61-R, CSE62-L, CSE62-R, CSG11-L, CSG11-R, CSG11-R-DG, CSG12-L, CSG12-R, CSG12-R-DG, CSG21-L, CSG21-R, CSG21-R-DG, CSG22-L, CSG22-R...(Other models you can see in the webshop)		

## drip water trays

			
1			
<b>Part No.</b>	692725	<b>Ref. No.</b>	202138
<b>description</b>	gutter for model 10.x L 605mm W 50mm H 20mm plastic		
<b>For models:</b>	CGE11-L, CGE11-R, CGE12-L, CGE12-R, CGE61-R, CGE62-R, CGG11-L, CGG11-R, CGG12-L, CGG12-R, CGG21-R, CGG61-L, CGG61-R, CGG62-L, CGG62-R, CSE11-L, CSE12-L, CSG11-L, CSG11-R, CSG12-L, CSG12-R, CSG61-L, CSG62-L		


## door mechanics

## door handles

			
1			
<b>Part No.</b>	696815	<b>Ref. No.</b>	207102
<b>description</b>	door handle for combi-steamer L 142mm W 36mm H 55mm grey plastic		
<b>For models:</b>	CCE60, CCE63, CPE60, CPE63		




miscellaneous



1

<b>Part No.</b>	691608	<b>Ref. No.</b>	211137
<b>description</b>	boiler gasket silicone ED ø 15mm suitable for MKN		
<b>For models:</b>	CGG11-L, CGG11-R, CGG12-L, CGG12-R, CGG21-L, CGG21-R, CGG22-L, CGG22-R, CGG61-L, CGG61-R, CGG62-L, CGG62-R, CSG11-L, CSG11-R, CSG11-R-DG, CSG12-L, CSG12-R, CSG12-R-DG, CSG21-L, CSG21-R, CSG21-R-DG, CSG22-L, CSG22-R, CSG22-R-DG, CSG61-L, CSG61-R, CSG61-R-DG, CSG62-L, CSG62-R, CSG62-R-DG		




1

<b>Part No.</b>	692850	<b>Ref. No.</b>	211166
<b>description</b>	cap gasket HDECOD623 D1 ø 19mm D2 ø 5mm ø 15mm		
<b>For models:</b>	CCE60, CCE63, CPE60, CPE63		



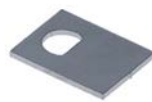
1

<b>Part No.</b>	694663	<b>Ref. No.</b>	203356
<b>description</b>	duct bore ø 30mm D1 ø 33.5mm D2 ø 30mm plastic H 12mm		
<b>For models:</b>	0220302A00, 0220302A01, 0220302A02, 0220302A03, 0220302C00, 0220302C01, 0220302C02, 0220302C03, 0220303A00, 0220303A01, 0220303A02, 0220303A03, 0220303C00, 0220303C01, 0220303C02, 0220304-00, 0220305-00, 0220306-00, 0720332R00, 0720332V00, 0723405-01, 0723405-02, 0723412K01, 0723414-02, 1220302-00, 1220302-01, 1220302B00, 1220302B01, 1220302D00, 1220302E00, 1220304-00, 1220304-01, 1220304A00, 1220304A01, 1220304A02, 1220304B00, 1220304B01, 1220304C00, 1220304C01, 1220304C02, 1220304D00, 1220304E00, 1220304F00, 1220304F01, 1220304H00, 1220304H01, 1220306-00, 1220306-01, 1220306A00, 1220306A01... (Other models you can see in the webshop)		



1

<b>Part No.</b>	694988	<b>Ref. No.</b>	204428
<b>description</b>	grommet connection bush Hans Dampf for spray gun		
<b>For models:</b>	CGE11-L, CGE11-R, CGE12-L, CGE12-R, CGE21-L, CGE21-R, CGE22-L, CGE22-R, CGE61-L, CGE61-R, CGE62-L, CGE62-R, CGG11-L, CGG11-R, CGG12-L, CGG12-R, CGG21-L, CGG21-R, CGG22-L, CGG22-R, CGG61-L, CGG61-R, CGG62-L, CGG62-R, CSE11-L, CSE11-R, CSE11-R-DG, CSE12-L, CSE12-R, CSE12-R-DG, CSE21-L, CSE21-R, CSE21-R-DG, CSE22-L, CSE22-R, CSE22-R-DG, CSE61-L, CSE61-R, CSE61-R-DG, CSE62-L, CSE62-R, CSE62-R-DG, CSG11-L, CSG11-R, CSG11-R-DG, CSG12-L, CSG12-R, CSG12-R-DG, CSG21-L, CSG21-R...(Other models you can see in the webshop)		



1

<b>Part No.</b>	694661	<b>Ref. No.</b>	866324
<b>description</b>	lever for stop bore ø 6x4.6mm L 17mm W 13mm thickness 1mm		
<b>For models:</b>	0021130A00, 0021130A01, 0021135A00, 2021115-00, 2021115-01, 2021115-02, 2021115-03, 2021115-04, 2221115-00, 2221115-01		




1

<b>Part No.</b>	692813	<b>Ref. No.</b>	201135
<b>description</b>	screen for drain D1 ø 90mm		
<b>For models:</b>	CGE11-L, CGE11-R, CGE12-L, CGE12-R, CGE21-L, CGE21-R, CGE22-L, CGE22-R, CGE61-L, CGE61-R, CGE62-L, CGE62-R, CGG11-L, CGG11-R, CGG12-L, CGG12-R, CGG21-L, CGG21-R, CGG22-L, CGG22-R, CGG61-L, CGG61-R, CGG62-L, CGG62-R, CSE11-L, CSE11-R, CSE11-R-DG, CSE12-L, CSE12-R, CSE12-R-DG, CSE21-L, CSE21-R, CSE21-R-DG, CSE22-L, CSE22-R, CSE22-R-DG, CSE61-L, CSE61-R, CSE61-R-DG, CSE62-L, CSE62-R, CSE62-R-DG, CSG11-L, CSG11-R, CSG11-R-DG, CSG12-L, CSG12-R, CSG12-R-DG, CSG21-L, CSG21-R...(Other models you can see in the webshop)		

for tilting bratt pans


spare parts and accessories



1

<b>Part No.</b>	693493	<b>Ref. No.</b>	204576
<b>description</b>	bush L 49mm ID ø 16mm ext. ø 20		

spindles



1

<b>Part No.</b>	514365	<b>Ref. No.</b>	110115
<b>description</b>	threaded rod		
<b>For models:</b>	2021403-00, 2021403-01, 2021403-02, 2021403-03, 2021403-04, 2021403-05, 2021403-06, 20214033-0, 2021403A00, 2021403A01, 2021403A02, 2021403A04, 2021403A05, 2021403A06, 2021403B00, 2021403B01, 2021403B02, 2021403B04, 2021403B05, 2021403B06, 2021403C01, 2021403C02, 2021403C04, 2021403C05, 2021403C06, 2021405-00, 2021405-01, 2021405-02, 2021405-03, 20214055-0, 2021405B00, 2021405B01, 2021405B02, 2021405B03, 2021413-00, 2021413B00, 2021415B00, 2021432C00, 2023001-00, 20230011-0, 20230011-1, 2023001A00, 2023001B00, 2023001C00, 2023003-00, 20230033-0, 20230033-1, 2023003A00, 2023003B00, 2023003C00... (Other models you can see in the webshop)		



## miscellaneous



1

<b>Part No.</b>	514366	<b>Ref. No.</b>	113118
<b>description</b>	threaded bush		
<b>For models:</b>	2021403-00, 2021403-01, 2021403-02, 2021403-03, 2021403-04, 2021403-05, 2021403-06, 20214033-0, 2021403A00, 2021403A01, 2021403A02, 2021403A04, 2021403A05, 2021403A06, 2021403B00, 2021403B01, 2021403B02, 2021403B04, 2021403B05, 2021403B06, 2021403C01, 2021403C02, 2021403C04, 2021403C05, 2021403C06, 2021405-00, 2021405-01, 2021405-02, 2021405-03, 20214055-0, 2021405B00, 2021405B01, 2021405B02, 2021405B03, 2021413-00, 2021413B00, 2021415B00, 2021432C00, 2023001-00, 20230011-0, 20230011-1, 2023001A00, 2023001B00, 2023001C00, 2023003-00, 20230033-0, 20230033-1, 2023003A00, 2023003B00, 2023003C00... (Other models you can see in the webshop)		

## for boiling pans

## gearboxes



1

<b>Part No.</b>	514365	<b>Ref. No.</b>	110115
<b>description</b>	threaded rod		
<b>For models:</b>	2021403-00, 2021403-01, 2021403-02, 2021403-03, 2021403-04, 2021403-05, 2021403-06, 20214033-0, 2021403A00, 2021403A01, 2021403A02, 2021403A04, 2021403A05, 2021403A06, 2021403B00, 2021403B01, 2021403B02, 2021403B04, 2021403B05, 2021403B06, 2021403C01, 2021403C02, 2021403C04, 2021403C05, 2021403C06, 2021405-00, 2021405-01, 2021405-02, 2021405-03, 20214055-0, 2021405B00, 2021405B01, 2021405B02, 2021405B03, 2021413-00, 2021413B00, 2021415B00, 2021432C00, 2023001-00, 20230011-0, 20230011-1, 2023001A00, 2023001B00, 2023001C00, 2023003-00, 20230033-0, 20230033-1, 2023003A00, 2023003B00, 2023003C00... (Other models you can see in the webshop)		

## knobs

## producer-specific knobs

## MKN



1

<b>Part No.</b>	110640	<b>Ref. No.</b>	209230 209236 209917
<b>description</b>	knob energy regulator 1-10 t.max. °C ø 53mm shaft ø 6x4.6mm shaft flat right black		
<b>For models:</b>	00217022-0, 0521701-00, 0521701-01, 0521702-00, 0521702-01, 0521702-02, 0521702-03, 0521702-04, 0521702A02, 0521702A03, 0521702A04, 0521702B03, 0521702B04, 0521702C04, 0521704-0, 0521704-00, 0521704-01, 0521704-02, 0521704-03, 0521704-04, 0521704-05, 0521704-06, 0521704-07, 0521705-00, 0521705-01		



1

<b>Part No.</b>	110637	<b>Ref. No.</b>	209227 209233 209909 209911
<b>description</b>	knob ON-OFF t.max. °C ø 54mm shaft ø 6x4.6mm shaft flat upper black		
<b>For models:</b>	0021130A00, 0021130A01, 0021135A00, 0120101-00, 0120101C00, 0120105-00, 0120105C00, 0220302F00, 0520302-00, 0520303-00, 0520303-01, 0520303-02, 0520901-00, 0522101-01, 0522101-02, 0522102-00, 0522102-01, 0522102-02, 1323208-00, 1323208-01, 1363403-00, 1422101-00, 1422101-01, 1422101-02, 1422102-00, 1422102-01, 1422102-02, 1424816-00, 1820301-00, 1820301-01, 2063403-00, 2063403-01, 2063403-02, 2063403-03, 2063403-04, 2063403-05, 2063406-00, 2063406-01, 2063406-02, 2063406-03, 2063406-04, 2063406-05, 2063415-00, 2063415-01, 2063415-02, 2063415-03, 2063415-04, 2063418-00, 2063418-01, 2063418-02... (Other models you can see in the webshop)		



1

<b>Part No.</b>	111887	<b>Ref. No.</b>	209226 209914
<b>description</b>	knob switch 7-position ø 53mm shaft ø 6x4.6mm shaft flat upper black		
<b>For models:</b>	1424816-00, 18232011-0		



1


<b>Part No.</b>	110638	<b>Ref. No.</b>	209229 209910
<b>description</b>	knob thermostat t.max. 110°C ø 53mm shaft ø 6x4.6mm shaft flat upper black temperature range 30-110°C		
<b>For models:</b>	0520901-00, 1224002-00, 1224002-01, 1224003-00, 1224003-01, 1224004-00, 1224004-01, 1224005-00, 1224005-01, 1224006-00, 1224006-01, 1224007-00, 1224007-01, 1224008-00, 1224008-01, 1224009-00, 1224009-01, 1820501-00, 18208011-0		




1


<b>Part No.</b>	110636	<b>Ref. No.</b>	209232 209233 209911
<b>description</b>	knob thermostat t.max. 185°C ø 53mm shaft ø 6x4.6mm shaft flat upper black temperature range 100-185°C rotation 270°		





			
1			
<b>Part No.</b>	110641	<b>Ref. No.</b>	209228 209912
<b>description</b>	knob thermostat t.max. 300°C ø 52mm shaft ø 6x4.6mm shaft flat upper black temperature range 50-300°C rotation 270°		
<b>For models:</b>	0021130A00, 0021130A01, 0021135A00, 0522101-01, 0522101-02, 0522102-00, 0522102-01, 0522102-02, 1323208-00, 1323208-01, 1363403-00, 1422101-00, 1422101-01, 1422101-02, 1422102-00, 1422102-01, 1422102-02, 1424816-00, 1821101-00, 2063403-00, 2063403-01, 2063403-02, 2063403-03, 2063403-04, 2063403-05, 2063406-00, 2063406-01, 2063406-02, 2063406-03, 2063406-04, 2063406-05, 2063415-00, 2063415-01, 2063415-02, 2063415-03, 2063415-04, 2063418-00, 2063418-01, 2063418-02, 2063418-03, 2063418-04, 2063502-00, 2063502-01, 2063502-02, 2063502-03, 2063502-04, 2063502-05, 2063502-06, 2063507-00, 2063507-01... (Other models you can see in the webshop)		


			
1			
<b>Part No.</b>	111867 <sup>1</sup>	<b>Ref. No.</b>	209906
<b>description</b>	knob gas tap with ignition flame t.max.°C ø 65mm shaft ø 6x4.6mm shaft flat left black for EGA24197/PEL		
<b>For models:</b>	0260501-00, 0261101-00, 0261101-01, 0261102-00, 0261102-01, 0261103-00, 0261103-01, 0261301-00, 0261601-00, 0263401-00, 0263401-01, 1261301-00, 1261301-01, 1261301-02, 1261601-00, 1261601-01, 1261602-00, 1261602-01, 1261602-02, 1261602-03, 1261604-03, 1263405-00, 1263405-01, 1361301-00, 1361301-01, 1361301-02, 1361301-03, 1361601-00, 1361601-01, 1361601-02, 1361602-00, 1361602-01, 1361602-02, 1361604-02, 1363405-00, 1363405-01, 1461601-00, 1461602-00, 1463501-00, 1463501-01, 1463501-02, 1463501-03, 1463501-04, 1463501-05, 2061301-01, 2061401-00, 2061401-01, 2061401A00, 2061401B00, 2061401C00... (Other models you can see in the webshop)		

for EGA24197/PEL

			
1			
<b>Part No.</b>	112731	<b>Ref. No.</b>	209239
<b>description</b>	knob thermostat t.max.°C 30-70°C ø 53mm shaft ø 6x4.6mm shaft flat left black		
<b>For models:</b>	0120201-01, 0120202-01, 0120203-01		

			
1			
<b>Part No.</b>	111433	<b>Ref. No.</b>	209282
<b>description</b>	knob gas tap with ignition flame t.max.°C ø 65mm shaft ø 6x4.6mm shaft flat lower black		
<b>For models:</b>	1263402-01, 1263402-02, 1263404-01, 1263404-02, 1263413-02, 1263414-02, 1363402-02, 1363403-04, 1363403-05, 1363404-02, 1363404-03, 1363413-03, 1363415-05, 1464802-02, 1464803-03, 1464808-03, 1464809-03, 1464810-02, 1464811-02, 1464812-01, 1464812-02, 2063401-05, 2063401-06, 2063402-05, 2063402-06, 2063403-09, 2063403-10, 2063404-06, 2063404-07, 2063405-05, 2063405-06, 2063406-09, 2063406-10, 2063407-06, 2063407-07, 2063420-01, 2063420-02, 2163401-04, 2163401-05, 2163402-04, 2163402-05, 2163403-08, 2163403-09, 2163404-05, 2163404-06, 2163405-04, 2163405-05, 2163406-08, 2163406-09, 2163407-05... (Other models you can see in the webshop)		


			
1			
<b>Part No.</b>	111862	<b>Ref. No.</b>	209904
<b>description</b>	knob energy regulator 1-10 t.max.°C ø 65mm shaft ø 6x4.6mm shaft flat upper black		
<b>For models:</b>	0221001H00, 0221202-00, 0221501-00, 0221502-00, 1022603-00, 1023401-00, 1023401K00, 1220402-00, 1220402-01, 1221501-00, 1221501-01, 1221501-02, 1222603-00, 1223202A00, 1223202A01, 1223202J00, 1223202J01, 1223203-00, 1223203-01, 1223203-02, 1223204-00, 1223204-01, 1223204-02, 1223205-00, 1223205-01, 1223205-02, 1223206-00, 1223206-01, 1223206-02, 1223209-00, 1223209-01, 1223211-00, 1223212-00, 1223213-00, 1223214-00, 1223401-00, 1223401J00, 1223401K00, 1223401L00, 1223402-00, 1223402K00, 1320402-00, 1320402-01, 1321501-00, 1321501-01, 1321501-02, 1321501-03, 1322603-00, 1323202A00, 1323202A01... (Other models you can see in the webshop)		

			
1			
<b>Part No.</b>	111863 <sup>1</sup>	<b>Ref. No.</b>	209907
<b>description</b>	knob gas tap with ignition flame t.max.°C ø 65mm shaft ø 6x4.6mm shaft flat right black for EGA24197/PEL		
<b>For models:</b>	0263401-00, 0263401-01, 2063413-00, 2063413-01, 2063413-02, 2063414-03, 2063415-05, 2063416-02, 2063417-03, 2063418-05, 2063419-02, 2163415-00, 3063413-00		


for EGA24197/PEL






			
1			
<b>Part No.</b>	111902 <sup>1</sup>	<b>Ref. No.</b>	209944
<b>description</b>	knob gas tap with ignition flame t.max.°C°C ø 65mm shaft ø 6x4.6mm shaft flat right black for EGA26400		
<b>For models:</b>	1260501-00, 1360501-00, 1360501-01		


<sup>1</sup>for EGA26440


			
1			
<b>Part No.</b>	111864 <sup>1</sup>	<b>Ref. No.</b>	209908
<b>description</b>	knob gas tap with ignition flame t.max.°C°C ø 65mm shaft ø 6x4.6mm shaft flat upper black for EGA24197/PEL		
<b>For models:</b>	20611011-0, 20611022-0, 20611033-0, 2061104-00, 20611044-0, 2061105-00, 20611055-0, 2061106-00, 20611066-0, 2063501-00, 2063501-01, 2063501-02, 2063501-03, 2063501-04, 2063501-05, 2063501-06, 2063501-1-0, 2063502-00, 2063502-01, 2063502-02, 2063502-03, 2063502-04, 2063502-05, 2063502-06, 2063502-07, 2063502-08, 2063502-09, 2063502-10, 20635022-0, 2063503-00, 2063503-01, 2063503-02, 2063503-03, 2063503-04, 2063503-05, 2063503-06, 2063503-07, 20635033-0, 2063504-00, 2063504-01, 2063504-02, 2063504-03, 20635044-0, 2063505-00, 20635055-0, 2063506-01, 2063506-02, 2063506-03, 2063506-04, 2063506-05... (Other models you can see in the webshop)		


<sup>1</sup>for EGA24197/PEL

			
1			
<b>Part No.</b>	111886 <sup>1</sup>	<b>Ref. No.</b>	209013
<b>description</b>	knob gas tap with ignition flame t.max.°C°C ø 65mm shaft ø 6x4.6mm shaft flat upper black for EGA26400		
<b>For models:</b>	1263401-00, 1263402-00, 1263404-00, 1363401-00, 1363402-00, 1363402-01, 1363403-00, 1363403-01, 1363403-02, 1363403-03, 1363404-00, 1363404-01, 1464802-01, 1464803-01, 1464803-02, 1464808-01, 1464808-02, 1464809-01, 1464809-02, 1464810-01, 1464811-01, 1464812-00, 2063401-00, 2063401-01, 2063401-02, 2063401-03, 2063401-04, 2063401-1-0, 2063402-00, 2063402-01, 2063402-02, 2063402-03, 2063402-04, 20634022-0, 2063403-00, 2063403-01, 2063403-02, 2063403-03, 2063403-04, 2063403-05, 2063403-06, 2063403-07, 2063403-08, 2063404-00, 2063404-01, 2063404-02, 2063404-03, 2063404-04, 2063404-05, 2063405-00... (Other models you can see in the webshop)		


<sup>1</sup>for EGA26440


			
1			
<b>Part No.</b>	111781	<b>Ref. No.</b>	209051
<b>description</b>	knob OECO/HAND t.max.°C°C ø 65mm shaft ø 6x4.6mm shaft flat upper		
<b>For models:</b>	1023401-00, 1023410-00, 1223202A00, 1223202A01, 1223202J00, 1223202J01, 1223209-00, 1223209-01, 1223401-00, 1223401J00, 1223402-00, 1323202A00, 1323202A01, 1323202A02, 1323209-00, 1323209-01, 1323209-02, 1323209-03, 1323210-00, 1323210-01, 1323210-02, 1323210-03, 1323210-04, 1323401-00, 1323402-00, 1323403-00, 1423401-00, 1423402-00, 1423404-00, 1423404-01, 1423405-00, 1423405-01, 1423405-02, 1423409-00, 1423409-01, 1423409-02, 1423414-02, 1424818A00, 1424819-00, 1424825-00, 1424826-00, 1523401-00, 1523402-00, 1523405-00, 1523405-01, 1523409-00, 1523409-01, 1523410-00, 2023206-00, 2023206-01... (Other models you can see in the webshop)		


			
1			
<b>Part No.</b>	111889	<b>Ref. No.</b>	209248
<b>description</b>	knob oven TH/BH/TH+BH t.max.°C°C ø 65mm shaft ø 6x4.6mm shaft flat right black		
<b>For models:</b>	0522101-03, 0522101-04, 0522102-03, 0522102-04, 1323208-02, 1323208-03, 1323208-04, 1323210-00, 1323210-01, 1323210-02, 1323210-03, 1323210-04, 1323403-00, 1323403K00, 1323506-00, 1323506-01, 1323506A00, 1323506A01, 1323517-00, 1323517A00, 1363403-01, 1363403-02, 1363403-03, 1363403-04, 1363403-05, 1363415-05, 1422101-03, 1422101-04, 1422101-05, 1422101-06, 1422102-03, 1422102-04, 1422102-05, 1422104-05, 1422104A05, 1422105-05, 1422105A05, 1422106-05, 1422106-06, 1422106A05, 1422106A06, 1422107-05, 1422107-06, 1422107A05, 1422107A06, 1422301-01, 2023114-00, 2023118-00, 2023119-00, 2023203-05... (Other models you can see in the webshop)		


			
1			
<b>Part No.</b>	112526	<b>Ref. No.</b>	209481
<b>description</b>	knob potentiometer t.max.°C°C ø 71mm shaft ø 6x4.6mm shaft flat upper with spring		
<b>For models:</b>	CGE11-L, CGE11-R, CGE12-L, CGE12-R, CGE21-L, CGE21-R, CGE22-L, CGE22-R, CGE61-L, CGE61-R, CGE62-L, CGE62-R, CGG11-L, CGG11-R, CGG12-L, CGG12-R, CGG21-L, CGG21-R, CGG22-L, CGG22-R, CGG61-L, CGG61-R, CGG62-L, CGG62-R, CPE60, CPE63, CSE11-L, CSE11-R, CSE12-L, CSE12-R, CSE21-L, CSE21-R, CSE22-L, CSE22-R, CSE61-L, CSE61-R, CSE62-L, CSE62-R, CSG11-L, CSG11-R, CSG12-L, CSG12-R, CSG21-L, CSG21-R, CSG22-L, CSG22-R, CSG61-L, CSG61-R, CSG62-L, CSG62-R		





			
1			
<b>Part No.</b>	111778	<b>Ref. No.</b>	209900
<b>description</b>	knob switch 0-1-0-1 t.max.°C ø 65mm shaft ø 6x4.6mm shaft flat upper black		
<b>For models:</b>	0220301-00, 0220301B00, 0220301B01, 0220301B02, 0220301D00, 0220302-00, 0220302A00, 0220302A01, 0220302A02, 0220302A03, 0220302B00, 0220302B01, 0220302B02, 0220302C00, 0220302C01, 0220302C02, 0220302C03, 0220302D00, 0220302E00, 0220302E01, 0220302H00, 0220302H01, 0220303-00, 0220303-01, 0220303A00, 0220303A01, 0220303A02, 0220303A03, 0220303B00, 0220303B01, 0220303C00, 0220303C01, 0220303C02, 0220303D00, 0220303D01, 0220303E00, 0220303E01, 0220303H00, 0220303H01, 0220304-00, 0220305-00, 0220306-00, 0220501-00, 0220502-00, 0220503-00, 0220601-00, 0220802-00, 0221001H00, 0221101-00, 0221101-01... (Other models you can see in the webshop)		

			
1			
<b>Part No.</b>	111800	<b>Ref. No.</b>	209222
<b>description</b>	knob t.max.°C ø 65mm shaft ø 6x4.6mm shaft flat upper black		
<b>For models:</b>	1461101-02, 1461102-02, 1461104-02, 1461105-02, 1461109-01, 1461109A01, 1461109A02, 2061107-01, 2061107A01, 3061101-01, 3061101-02, 3061102-01, 3061102-02, 3061107-01, 3061107A01		


			
1			
<b>Part No.</b>	110198	<b>Ref. No.</b>	209012
<b>description</b>	knob switch 4-position t.max.°C ø 65mm shaft ø 6x4.6mm shaft flat upper black		
<b>For models:</b>	1220304-00, 1220304-01, 1220304A00, 1220304A01, 1220304A02, 1220304B00, 1220304B01, 1220304C00, 1220304C01, 1220304C02, 1220304D00, 1220304E00, 1220304F00, 1220304F01, 1220304H00, 1220304H01, 1220504-01, 1222601-00, 1320304-00, 1320304-01, 1320304A00, 1320304A01, 1320304A02, 1320304B00, 1320304B01, 1320304C00, 1320304C01, 1320304C02, 1320304D00, 1320304D01, 1320304E00, 1320304E01, 1320304F00, 1320304F01, 1320304F02, 1320304F03, 1320304F04, 1320304H00, 1320304H01, 1320304H02, 1320304H03, 1320304H04, 1320504-01, 1320504-02, 1322601-00, 1420509-01, 1422601-00, 1422602-00, 1422802B04, 1422802B05... (Other models you can see in the webshop)		


			
1			
<b>Part No.</b>	111780	<b>Ref. No.</b>	209052
<b>description</b>	knob thermostat 1-10 t.max.°C ø 65mm shaft ø 6x4.6mm shaft flat upper		
<b>For models:</b>	1023410-00, 1423404-00, 1423404-01, 1423405-00, 1423405-01, 1423405-02, 1423409-00, 1423409-01, 1423409-02, 1423414-02, 1424819-00, 1424826-00, 1523405-00, 1523405-01, 1523409-00, 1523409-01, 1523410-00, 2023206-00, 2023206-01, 2023206-02, 2023207-00, 2023207-01, 2023207-02, 2023207-03, 2023207-04, 2023207-05, 2023405-00, 2023405D00, 2023406-00, 2023409-00, 3023206-00, 3023206-01, 3023206-02, 3023405-00, 3023406-00, 3023409-00		


			
1			
<b>Part No.</b>	111779	<b>Ref. No.</b>	209905
<b>description</b>	knob switch 7-position t.max.°C ø 65mm shaft ø 6x4.6mm shaft flat upper black		
<b>For models:</b>	0223202-00, 1223201-00, 1223201-01, 1223202-00, 1223207-00, 1223207-01, 1320401-00, 1320401-01, 1323201-00, 1323201-01, 1323201-02, 1323207-00, 1323207-02, 1323208-00, 1323208-01, 1323208-02, 1323208-03, 1323208-04, 1420401-00, 1420401-01, 1424802-00, 1424802-01, 1424802-02, 1424808-00, 1424808-01, 1424808-02, 1424808-03, 1424809-00, 1424809-01, 1424809-02, 1424809-03, 1424809-04, 1424811-00, 1424811-01, 1424811-02, 1424811-03, 1424812-00, 1424812-01, 1424812-02, 1424813-00, 1424813-01, 1424813-02, 2020401-00, 2020401-01, 2023201-00, 2023201-01, 2023201-02, 2023201-03, 2023201-04, 2023201-05, 2023201-06, 2023201-07, 2023201-08, 2023201-09, 2023201-10, 2023201-11, 2023202-00... (Other models you can see in the webshop)		


			
1			
<b>Part No.</b>	111868	<b>Ref. No.</b>	209930
<b>description</b>	knob thermostat 1-10 t.max.°C ø 65mm shaft ø 6x4.6mm shaft flat upper		
<b>For models:</b>	1223215-00, 1223215A00, 1223216-00, 1223216A00, 1223504A00, 1223505-00, 1223505A00, 1323504-00, 1323504A00, 1323505-00, 1323505A00, 1323506-00, 1323506A00, 1323515-00, 1323515A00, 1323516-00, 1323516A00, 1323517-00, 1323517A00, 1423501-00, 1423501A00, 1423502-00, 1423502-01, 1423502A00, 1423502A01, 1423504-00, 1423504A00, 1423505-00, 1423505A00, 1423507A00, 1423508A00, 1423524A00, 1423525A00, 1424814-00, 1424814-01, 1424814-02, 1424814-03, 1424814-04, 1424814A00, 1424814A01, 1424814A03, 1424814A04, 1424815-00, 1424815-01, 1424815-02, 1424815-03, 1424815-04, 1424815A00, 1424815A01, 1424815A03... (Other models you can see in the webshop)		




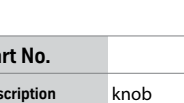
			
1			
<b>Part No.</b>	110199	<b>Ref. No.</b>	209901
<b>description</b>	knob thermostat t.max. 110°C ø 65mm shaft ø 6x4.6mm shaft flat upper black temperature range 30-110°C rotation 270°		
<b>For models:</b>	0220501-00, 0220502-00, 0220503-00, 0220802-00, 1020510-00, 1022603-00, 1120510-00, 1120510-01, 1220402-00, 1220402-01, 1220501-00, 1220501-01, 1220501-02, 1220502-00, 1220502-01, 1220503-00, 1220504-01, 1220802-00, 1220802-01, 1222601-00, 1222603-00, 1320402-00, 1320402-01, 1320501-00, 1320501A00, 1320501A01, 1320502-00, 1320502A00, 1320502A01, 1320504-01, 1320504-02, 1320802-00, 1320802A00, 1322601-00, 1322603-00, 1420402-00, 1420402-01, 1420405-00, 1420501-00, 1420501-01, 1420501-02, 1420501-03, 1420502-00, 1420502-01, 1420502-02, 1420504-00, 1420504-01, 1420504-02, 1420504-03, 1420504-04... (Other models you can see in the webshop)		


			
1			
<b>Part No.</b>	111938	<b>Ref. No.</b>	209075
<b>description</b>	knob time 15min t.max. °C ø 65mm shaft ø 6x4.6mm shaft flat upper black		
<b>For models:</b>	0220302A03, 0220302C03, 0220302H01, 0220303A03, 0220303C02, 0220303H01, 1220303A00, 1220303A01, 1220303A02, 1220303A03, 1220303C00, 1220303C01, 1220303C02, 1220303C03, 1220303F01, 1220303F02, 1220303F03, 1220303H00, 1220303H01, 1220303H02, 1220303H03, 1220305A00, 1220305A01, 1220305A02, 1220305A03, 1220305A04, 1220305A05, 1220305C00, 1220305C01, 1220305C02, 1220305C03, 1220305C04, 1220305C05, 1220305E00, 1220305E01, 1220305F01, 1220305F02, 1220305F03, 1220305F04, 1220305F05, 1220305H00, 1220305H01, 1220305H02, 1220305H03, 1220305H04, 1220305H05, 1320303A00, 1320303A01, 1320303A02, 1320303C00... (Other models you can see in the webshop)		

			
2			
<b>Part No.</b>	111905	<b>Ref. No.</b>	209902
<b>description</b>	knob thermostat t.max. 185°C ø 65mm shaft ø 6x4.6mm shaft flat upper black temperature range 100-185°C rotation 270°		
<b>For models:</b>	0220301-00, 0220301B00, 0220301B01, 0220301B02, 0220301D00, 0220302-00, 0220302A00, 0220302A01, 0220302A02, 0220302A03, 0220302B00, 0220302B01, 0220302B02, 0220302C00, 0220302C01, 0220302C02, 0220302C03, 0220302D00, 0220302E00, 0220302E01, 0220302H00, 0220302H01, 0220303-00, 0220303-01, 0220303A00, 0220303A01, 0220303A02, 0220303A03, 0220303B00, 0220303B01, 0220303C00, 0220303C01, 0220303C02, 0220303D00, 0220303D01, 0220303E00, 0220303E01, 0220303H00, 0220303H01, 0220304-00, 0220305-00, 0220306-00, 0720332R00, 0720332V00, 1220301-00, 1220301-01, 1220301-02, 1220301-03, 1220301-04, 1220301B00... (Other models you can see in the webshop)		

			
1			
<b>Part No.</b>	112801	<b>Ref. No.</b>	209918
<b>description</b>	knob zero mark ø 65mm MKN shaft ø 6x4.6mm shaft flat upper black		
<b>For models:</b>	14228011-0, 14228022-0, 14228033-0, 14228044-0, 14228055-0, 2012801-00, 2012801-01, 2012801A00, 2012801A01, 2012801B00, 2012801B01, 2012801C00, 2012801C01, 2012802-00, 2012802-01, 2012802A00, 2012802A01, 2012802B00, 2012802B01, 2012802C00, 2012802C01, 2012803-00, 2012803-01, 2012803A00, 2012803A01, 2012803B00, 2012803B01, 2012803C00, 2012803C01, 2012804-00, 2012804-01, 2012804A00, 2012804A01, 2012804B00, 2012804B01, 2012804C00, 2012804C01, 2012805-00, 2012805-01, 2012805A00, 2012805A01, 2012805B00, 2012805B01, 2012805C00, 2012805C01, 2012806B00, 2012806C00, 2012807B00, 2012807C00, 2012901B00... (Other models you can see in the webshop)		

			
1			
<b>Part No.</b>	111888	<b>Ref. No.</b>	209903
<b>description</b>	knob thermostat t.max. 300°C 50-300°C ø 65mm shaft ø 6x4.6mm shaft flat upper black rotation 270°		
<b>For models:</b>	0221101-00, 0221101-01, 0221101A00, 0221101A01, 0221102-00, 0221102-01, 0221103-00, 0221103-01, 0221104-00, 0221104-01, 0221104A00, 0221104A01, 0221105-00, 0221105-01, 0221106-00, 0221106-01, 0221107-00, 0221107A00, 0221108-00, 0221109-00, 0221109A00, 0221110-00, 0522101-00, 0522101-03, 0522101-04, 0522102-03, 0522102-04, 1121117-00, 1121117-01, 1121117A00, 1121118-00, 1121118-01, 1121119-00, 1121119A00, 1121120-00, 1121121-00, 1121121A00, 1121135A01, 1221101-00, 1221101A00, 1221101B00, 1221102-00, 1221102A00, 1221102B00, 1221103-00, 1221103-01, 1221103-02, 1221103-04, 1221103A00, 1221103A01... (Other models you can see in the webshop)		

			
1			
<b>Part No.</b>		<b>Ref. No.</b>	580029
<b>description</b>	knob		

			
1			
<b>Part No.</b>	111885	<b>Ref. No.</b>	209224
<b>description</b>	knob switch zero mark ø 21mm shaft ø 6mm black		



1

<b>Part No.</b>		<b>Ref. No.</b>	580030
<b>description</b>	knob		

1

<b>Part No.</b>		<b>Ref. No.</b>	209007
<b>description</b>	knob		

1

<b>Part No.</b>		<b>Ref. No.</b>	209024
<b>description</b>	knob		

1

<b>Part No.</b>	690965	<b>Ref. No.</b>	216076
<b>description</b>	hand wheel ø 175mm D1 ø 40mm bore ø 16mm thread M6 hole distance 7mm groove widthmm L1 42mm L2 55mm handle length 80mm with folding handle		
<b>For models:</b>	2013003B04, 2013003B05, 2013003B06, 2013007B04, 2013007B05, 2013007B06, 2013009B04, 2013009B05, 2013009B06, 2013017B03, 2013017B04, 2013017B05, 2021401-09, 2021401A09, 2021401B09, 2021401C09, 2021407-03, 2021407A03, 2021407B03, 2021407C03, 2021409-02, 2021409B02, 2021430-01, 2021430-02, 2021430A01, 2021430A02, 2021430B02, 2021430B03, 2021430C02, 2021430C03, 2021436-02, 2021436-03, 2021436A02, 2021436A03, 2021436B02, 2021436B03, 2021436C02, 2021436C03, 2021440-04, 2021440-05, 2021440A04, 2021440A05, 2021440B04, 2021440B05, 2021440C04, 2021440C05, 2021441-04, 2021441-05, 2021441-06, 2021441-07... (Other models you can see in the webshop)		
<b>accessories for</b>	690965		
		<b>Part No.</b>	560555 <b>Ref. No.</b> —
	hexagonal screw thread M6 thread L 15mm SS WS 10 Qty 1 pcs DIN 933 / ISO 4017		

## handles and hand wheels

### hand wheels

### hand wheels

1

<b>Part No.</b>	690966	<b>Ref. No.</b>	216004
<b>description</b>	hand wheel ø 175mm D1 ø 40mm bore ø 16mm thread M6 hole distance 7mm groove widthmm L1 41mm L2 55mm handle length 80mm with folding handle with fixing kit		
<b>For models:</b>	2013003B01, 2013003B02, 2013003B03, 2013007B01, 2013007B02, 2013007B03, 2013009B01, 2013009B02, 2013009B03, 2013017B00, 2013017B01, 2013017B02, 2021401-02, 2021401-03, 2021401-04, 2021401-05, 2021401-06, 2021401-07, 2021401-08, 2021401A01, 2021401A02, 2021401A03, 2021401A04, 2021401A06, 2021401A07, 2021401A08, 2021401B01, 2021401B02, 2021401B03, 2021401B04, 2021401B06, 2021401B07, 2021401B08, 2021401C01, 2021401C02, 2021401C03, 2021401C04, 2021401C06, 2021401C07, 2021401C08, 2021405C00, 2021407-00, 2021407-01, 2021407-02, 2021407A02, 2021407B00, 2021407B01, 2021407B02, 2021407C02, 2021409-00... (Other models you can see in the webshop)		

1


<b>Part No.</b>	690964	<b>Ref. No.</b>	216907
<b>description</b>	hand wheel ø 200mm D1 ø 40mm bore ø 20mm thread M6 groove widthmm L1 20mm L2 60mm handle length 90mm with folding handle		
<b>For models:</b>	2021403-00, 2021403-01, 2021403-02, 2021403-03, 2021403-04, 2021403-05, 2021403-06, 20214033-0, 2021403A00, 2021403A01, 2021403A02, 2021403A04, 2021403A05, 2021403A06, 2021403B00, 2021403B01, 2021403B02, 2021403B04, 2021403B05, 2021403B06, 2021403C01, 2021403C02, 2021403C04, 2021403C05, 2021403C06, 2021405-00, 2021405-01, 2021405-02, 2021405-03, 20214055-0, 2021405B00, 2021405B01, 2021405B02, 2021405B03, 2021413-00, 2021413B00, 2021415B00, 2021432C00, 2023001-00, 20230011-0, 20230011-1, 2023001A00, 2023001B00, 2023001C00, 2023003-00, 20230033-0, 20230033-1, 2023003A00, 2023003B00, 2023003C00... (Other models you can see in the webshop)		
<b>spare parts for</b>	690964		
		<b>Part No.</b>	690859 <b>Ref. No.</b> —
	folding handle ø 28mm total length 110mm seat ø 26mm shaft ømm thread M6 with pin L 110mm		



## ball handles



1

<b>Part No.</b>	693474	<b>Ref. No.</b>	207035
<b>description</b>	ball handle ø 40mm bore ø conical 12mm for drive into black		
<b>For models:</b>	0521704-00, 0521704-02, 0521704-03, 0521704-04, 0521704-05, 0521704-06, 0521704-07, 0521704A00, 0521704A01, 0521705-00, 0521705-01, 0522101-00, 0522101-01, 0522101-02, 0522101-03, 0522101-04, 0522102-00, 0522102-01, 0522102-02, 0522102-03, 0522102-04, 0722101-06, 1323208-00, 1323208-01, 1323208-02, 1323208-03, 1323208-04, 1323210-00, 1323210-01, 1323210-02, 1323210-03, 1323210-04, 1323403-00, 1323403K00, 1323506-00, 1323506-01, 1323506A00, 1323506A01, 1323517-00, 1323517A00, 1363403-00, 1363403-01, 1363403-02, 1363403-03, 1363403-04, 1363403-05, 1363415-05, 1412831-00, 1412832-00, 1412833-00... (Other models you can see in the webshop)		
<b>accessories for</b>	693474		
		<b>Part No.</b>	696529
		<b>Ref. No.</b>	—
	lever for ball handle thread M8x1.25 ø 12/14mm angled 90° SS		

## lever handles



1

<b>Part No.</b>	692814	<b>Ref. No.</b>	10013388
<b>description</b>	door handle plastic ø 48mm L 190mm suitable for MKN black		

## door handles

## door handles



1

<b>Part No.</b>	693473	<b>Ref. No.</b>	207179
<b>description</b>	door handle metal dimensions ø10mm		
<b>For models:</b>	0522101-00, 0522101-01, 0522101-02, 0522101-03, 0522101-04, 0522102-00, 0522102-01, 0522102-02, 0522102-03, 0522102-04, 0722101-06, 1323208-00, 1323208-01, 1323208-02, 1323208-03, 1323208-04, 1323210-00, 1323210-01, 1323210-02, 1323210-03, 1323210-04, 1323403-00, 1323403K00, 1323506-00, 1323506-01, 1323506A00, 1323506A01, 1323517-00, 1323517A00, 1363403-00, 1363403-01, 1363403-02, 1363403-03, 1363403-04, 1363403-05, 1363415-05, 1422101-00, 1422101-01, 1422101-02, 1422101-03, 1422101-04, 1422101-05, 1422101-06, 1422102-00, 1422102-01, 1422102-02, 1422102-03, 1422102-04, 1422102-05, 1422104-05... (Other models you can see in the webshop)		

## locks

## electromagnetic closer



1

<b>Part No.</b>	692216	<b>Ref. No.</b>	203768
<b>description</b>	electromagnetic closer 24V voltage DC L 104mm W 24mm H 34mm series 8440		
<b>For models:</b>	CPE63		





## handle latches

## producer-specific

## MKN





1


<b>Part No.</b>	691666	<b>Ref. No.</b>	207092
<b>description</b>	catch clamp length 46mm BL 31mm for off-set 59-69mm		
<b>For models:</b>	CGE11-L, CGE11-R, CGE12-L, CGE12-R, CGE61-L, CGE61-R, CGE62-L, CGE62-R, CGG11-L, CGG11-R, CGG12-L, CGG12-R, CGG61-L, CGG61-R, CGG62-L, CGG62-R, CSE11-L, CSE11-R, CSE11-R-DG, CSE12-L, CSE12-R, CSE12-R-DG, CSE61-L, CSE61-R, CSE61-R-DG, CSE62-L, CSE62-R, CSE62-R-DG, CSG11-L, CSG11-R, CSG11-R-DG, CSG12-L, CSG12-R, CSG12-R-DG, CSG61-L, CSG61-R, CSG61-R-DG, CSG62-L, CSG62-R, CSG62-R-DG		
<b>spare parts for</b>	691666		
		<b>Part No.</b>	514390
		<b>Ref. No.</b>	—
	spring for door handle ø 6mm L 54mm W 27.5mm		
<b>accessories for</b>	691666		
		<b>Part No.</b>	691780
		<b>Ref. No.</b>	207090
	door catch L 24mm H 21mm thread M8 thread L 20mm		
		<b>Part No.</b>	694066
		<b>Ref. No.</b>	—
	door catch with spigot 2-stage L 28mm W 14mm H 15mm H1 16mm total length 51mm thread M8 thread L 23mm stainless steel		
		<b>Part No.</b>	694067
		<b>Ref. No.</b>	—
	door catch with spigot 1-stage L 26mm total length 51mm thread M8		







 <p>1</p>			
<b>Part No.</b>	692726	<b>Ref. No.</b>	10012036
<b>description</b>	catch for combi-steamer mounting thread M4/M8 clamp length 48mm BL 45mm ø 42mm		
<b>For models:</b>	CGE11-L, CGE11-R, CGE12-L, CGE12-R, CGE61-L, CGE61-R, CGE62-L, CGE62-R, CGG11-L, CGG11-R, CGG12-L, CGG12-R, CGG61-L, CGG61-R, CGG62-L, CGG62-R, CSE11-L, CSE11-R, CSE11-R-DG, CSE12-L, CSE12-R, CSE12-R-DG, CSE61-L, CSE61-R, CSE61-R-DG, CSE62-L, CSE62-R, CSE62-R-DG, CSG11-L, CSG11-R, CSG11-R-DG, CSG12-L, CSG12-R, CSG12-R-DG, CSG61-L, CSG61-R, CSG61-R-DG, CSG62-L, CSG62-R, CSG62-R-DG		


 <p>2</p>			
<b>Part No.</b>	694660	<b>Ref. No.</b>	207094
<b>description</b>	catch L 103mm clamp length 60mm		
<b>For models:</b>	CGE21-L, CGE21-R, CGE22-L, CGE22-R, CGG21-L, CGG21-R, CGG22-L, CGG22-R, CSE21-L, CSE21-R, CSE22-L, CSE22-R, CSG21-L, CSG21-R, CSG22-L, CSG22-R		


 <p>1</p>			
<b>Part No.</b>	699292	<b>Ref. No.</b>	203737
<b>description</b>	counterpart for door handle L 136mm W 34mm H 42mm hole ø 18mm		
<b>For models:</b>	CCE60, CCE63, CPE60, CPE63		


 <p>1</p>			
<b>Part No.</b>	694662	<b>Ref. No.</b>	203667
<b>description</b>	cover for door latch plastic grey L 185mm W 48mm mounting distance 186mm D 37mm		
<b>For models:</b>	CGE11-L, CGE11-R, CGE12-L, CGE12-R, CGE21-L, CGE21-R, CGE22-L, CGE22-R, CGE61-L, CGE61-R, CGE62-L, CGE62-R, CGG11-L, CGG11-R, CGG12-L, CGG12-R, CGG21-L, CGG21-R, CGG22-L, CGG22-R, CGG61-L, CGG61-R, CGG62-L, CGG62-R, CSE11-L, CSE11-R, CSE12-L, CSE12-R, CSE21-L, CSE21-R, CSE22-L, CSE22-R, CSE61-L, CSE61-R, CSE62-L, CSE62-R, CSG11-L, CSG11-R, CSG12-L, CSG12-R, CSG21-L, CSG21-R, CSG22-L, CSG22-R, CSG61-L, CSG61-R, CSG62-L, CSG62-R		


 <p>1</p>			
<b>Part No.</b>	696809	<b>Ref. No.</b>	207101
<b>description</b>	door catch for combi-steamer L 42mm W 30mm H 36mm mounting thread M5		
<b>For models:</b>	CCE60, CCE63, CPE60, CPE63		

 <p>1</p>			
<b>Part No.</b>	692767	<b>Ref. No.</b>	207144
<b>description</b>	door catch for combi-steamer with roller L 44mm W 11.5mm H 11.5mm M6 thread L 18mm B1 6mm rollerø 7.8mm		
<b>For models:</b>	CPE63		


 <p>1</p>			
<b>Part No.</b>	691780	<b>Ref. No.</b>	207090
<b>description</b>	door catch L 24mm H 21mm thread M8 thread L 20mm		
<b>For models:</b>	CGE11-L, CGE11-R, CGE12-L, CGE12-R, CGE21-L, CGE21-R, CGE22-L, CGE22-R, CGE61-L, CGE61-R, CGE62-L, CGE62-R, CGG11-L, CGG11-R, CGG12-L, CGG12-R, CGG21-L, CGG21-R, CGG22-L, CGG22-R, CGG61-L, CGG61-R, CGG62-L, CGG62-R, CSE11-L, CSE11-R, CSE11-R-DG, CSE12-L, CSE12-R, CSE12-R-DG, CSE21-L, CSE21-R, CSE22-L, CSE22-R, CSE61-L, CSE61-R, CSE61-R-DG, CSE62-L, CSE62-R, CSE62-R-DG, CSG11-L, CSG11-R, CSG11-R-DG, CSG12-L, CSG12-R, CSG12-R-DG, CSG21-L, CSG21-R, CSG22-L, CSG22-R...(Other models you can see in the webshop)		


 <p>1</p>			
<b>Part No.</b>	705011	<b>Ref. No.</b>	207103
<b>description</b>	door catch L 57mm W 13mm mounting thread 6mm BL 6mm		
<b>For models:</b>	CCE60, CCE63, CPE60, CPE63		


 <p>1</p>			
<b>Part No.</b>	696815	<b>Ref. No.</b>	207102
<b>description</b>	door handle for combi-steamer L 142mm W 36mm H 55mm grey plastic		
<b>For models:</b>	CCE60, CCE63, CPE60, CPE63		

 <p>1</p>			
<b>Part No.</b>	692766	<b>Ref. No.</b>	207143
<b>description</b>	door handle for combi-steamer L 143mm W 37mm H 59mm grey plastic		
<b>For models:</b>	CPE63		





			
1			
<b>Part No.</b>	691617	<b>Ref. No.</b>	207089
<b>description</b>	door handle grey plastic		
<b>For models:</b>	CGE11-L, CGE11-R, CGE12-L, CGE12-R, CGE21-L, CGE21-R, CGE22-L, CGE22-R, CGE61-L, CGE61-R, CGE62-L, CGE62-R, CGG11-L, CGG11-R, CGG12-L, CGG12-R, CGG21-L, CGG21-R, CGG22-L, CGG22-R, CGG61-L, CGG61-R, CGG62-L, CGG62-R, CSE11-L, CSE11-R, CSE11-R-DG, CSE12-L, CSE12-R, CSE12-R-DG, CSE21-L, CSE21-R, CSE22-L, CSE22-R, CSE61-L, CSE61-R, CSE61-R-DG, CSE62-L, CSE62-R, CSE62-R-DG, CSG11-L, CSG11-R, CSG11-R-DG, CSG12-L, CSG12-R, CSG12-R-DG, CSG21-L, CSG21-R, CSG22-L, CSG22-R...(Other models you can see in the webshop)		
<b>accessories for</b>	691617		
	<b>Part No.</b>	691666	<b>Ref. No.</b> 207092
	catch clamp length 46mm BL 31mm for off-set 59-69mm		
	<b>Part No.</b>	691777	<b>Ref. No.</b> 202662
	cover cap plastic grey L 94mm W 40mm mounting distance 75mm D 36mm		
	<b>Part No.</b>	691780	<b>Ref. No.</b> 207090
	door catch L 24mm H 21mm thread M8 thread L 20mm		
	<b>Part No.</b>	691782	<b>Ref. No.</b> 801064
	cover plate round ø 40mm thickness 1mm		
	<b>Part No.</b>	691783	<b>Ref. No.</b> 801059
	cover plate rectangular L 35mm W 14mm thickness 1mm		

			
1			
<b>Part No.</b>	691785	<b>Ref. No.</b>	207147
<b>description</b>	catch L 97mm clamp length 54mm BL 39mm ø 51.5mm		
<b>For models:</b>	CGE21-L, CGE21-R, CGE22-L, CGE22-R, CGG21-L, CGG21-R, CGG22-L, CGG22-R, CSE21-L, CSE21-R, CSE21-R-DG, CSE22-L, CSE22-R, CSE22-R-DG, CSG21-L, CSG21-R, CSG21-R-DG, CSG22-L, CSG22-R, CSG22-R-DG		


			
1			
<b>Part No.</b>	691786	<b>Ref. No.</b>	207148
<b>description</b>	door catch L 38mm H 19mm thread M8 thread L 21mm		
<b>For models:</b>	CGE21-L, CGE21-R, CGE22-L, CGE22-R, CGG21-L, CGG21-R, CGG22-L, CGG22-R, CSE21-L, CSE21-R, CSE21-R-DG, CSE22-L, CSE22-R, CSE22-R-DG, CSG21-L, CSG21-R, CSG21-R-DG, CSG22-L, CSG22-R, CSG22-R-DG		


			
1			
<b>Part No.</b>	691784	<b>Ref. No.</b>	207149
<b>description</b>	door handle L 200mm W 32mm H 70mm grey plastic		
<b>For models:</b>	CGE21-L, CGE21-R, CGE22-L, CGE22-R, CGG21-L, CGG21-R, CGG22-L, CGG22-R, CSE21-L, CSE21-R, CSE21-R-DG, CSE22-L, CSE22-R, CSE22-R-DG, CSG21-L, CSG21-R, CSG21-R-DG, CSG22-L, CSG22-R, CSG22-R-DG		
<b>accessories for</b>	691784		
	<b>Part No.</b>	691777	<b>Ref. No.</b> 202662
	cover cap plastic grey L 94mm W 40mm mounting distance 75mm D 36mm		
	<b>Part No.</b>	691781	<b>Ref. No.</b> 802694
	cover plate round ø 38mm thickness 1mm		
	<b>Part No.</b>	691785	<b>Ref. No.</b> 207147
	catch L 97mm clamp length 54mm BL 39mm ø 51.5mm		
	<b>Part No.</b>	691786	<b>Ref. No.</b> 207148
	door catch L 38mm H 19mm thread M8 thread L 21mm		


			
1			
<b>Part No.</b>	691777	<b>Ref. No.</b>	202662
<b>description</b>	cover cap plastic grey L 94mm W 40mm mounting distance 75mm D 36mm		
<b>For models:</b>	CGE11-L, CGE11-R, CGE12-L, CGE12-R, CGE21-L, CGE21-R, CGE22-L, CGE22-R, CGE61-L, CGE61-R, CGE62-L, CGE62-R, CGG11-L, CGG11-R, CGG12-L, CGG12-R, CGG21-L, CGG21-R, CGG22-L, CGG22-R, CGG61-L, CGG61-R, CGG62-L, CGG62-R, CSE11-L, CSE11-R, CSE11-R-DG, CSE12-L, CSE12-R, CSE12-R-DG, CSE21-L, CSE21-R, CSE21-R-DG, CSE22-L, CSE22-R, CSE22-R-DG, CSE61-L, CSE61-R, CSE61-R-DG, CSE62-L, CSE62-R, CSE62-R-DG, CSG11-L, CSG11-R, CSG11-R-DG, CSG12-L, CSG12-R, CSG12-R-DG, CSG21-L, CSG21-R...(Other models you can see in the webshop)		


			
1			
<b>Part No.</b>	691783	<b>Ref. No.</b>	801059
<b>description</b>	cover plate rectangular L 35mm W 14mm thickness 1mm		
<b>For models:</b>	CGE11-L, CGE11-R, CGE12-L, CGE12-R, CGE61-L, CGE61-R, CGE62-L, CGE62-R, CGG11-L, CGG11-R, CGG12-L, CGG12-R, CGG61-L, CGG61-R, CGG62-L, CGG62-R, CSE11-L, CSE11-R, CSE11-R-DG, CSE12-L, CSE12-R, CSE12-R-DG, CSE61-L, CSE61-R, CSE61-R-DG, CSE62-L, CSE62-R, CSE62-R-DG, CSG11-L, CSG11-R, CSG11-R-DG, CSG12-L, CSG12-R, CSG12-R-DG, CSG61-L, CSG61-R, CSG61-R-DG, CSG62-L, CSG62-R, CSG62-R-DG		



			
1			
<b>Part No.</b>	691781	<b>Ref. No.</b>	802694
<b>description</b>	cover plate round ø 38mm thickness 1mm		
<b>For models:</b>	CGE21-L, CGE21-R, CGE22-L, CGE22-R, CGG21-L, CGG21-R, CGG22-L, CGG22-R, CSE21-L, CSE21-R, CSE21-R-DG, CSE22-L, CSE22-R, CSE22-R-DG, CSG21-L, CSG21-R, CSG21-R-DG, CSG22-L, CSG22-R, CSG22-R-DG		

			
1			
<b>Part No.</b>	691782	<b>Ref. No.</b>	801064
<b>description</b>	cover plate round ø 40mm thickness 1mm		
<b>For models:</b>	CGE11-L, CGE11-R, CGE12-L, CGE12-R, CGE21-L, CGE21-R, CGE22-L, CGE22-R, CGE61-L, CGE61-R, CGE62-L, CGE62-R, CGG11-L, CGG11-R, CGG12-L, CGG12-R, CGG21-L, CGG21-R, CGG22-L, CGG22-R, CGG61-L, CGG61-R, CGG62-L, CGG62-R, CSE11-L, CSE11-R, CSE11-R-DG, CSE12-L, CSE12-R, CSE12-R-DG, CSE21-L, CSE21-R, CSE22-L, CSE22-R, CSE61-L, CSE61-R, CSE61-R-DG, CSE62-L, CSE62-R, CSE62-R-DG, CSG11-L, CSG11-R, CSG11-R-DG, CSG12-L, CSG12-R, CSG12-R-DG, CSG21-L, CSG21-R, CSG22-L, CSG22-R...(Other models you can see in the webshop)		

			
1			
<b>Part No.</b>	520507	<b>Ref. No.</b>	201093
<b>description</b>	outlet tap brass L 210mm thread 1/2" IT - 3/4" IT		
<b>For models:</b>	0220301-00, 0220301B00, 0220301B01, 0220301B02, 0220302-00, 0220302A00, 0220302A01, 0220302A02, 0220302A03, 0220302B00, 0220302B01, 0220302B02, 0220302C00, 0220302C01, 0220302C02, 0220302C03, 0220302F00, 0220303-00, 0220303-01, 0220303A00, 0220303A01, 0220303A02, 0220303A03, 0220303B00, 0220303B01, 0220303C00, 0220303C01, 0220303C02, 0220304-00, 0220305-00, 0220306-00		


			
1			
<b>Part No.</b>	520536	<b>Ref. No.</b>	201114
<b>description</b>	outlet tap L 175mm thread 1/2" IT - 3/4" IT shaft L 92mm total length 174mm shaft intake ø 6x6mm shaft ø 8mm		
<b>For models:</b>	1220301-00, 1220301-01, 1220301-02, 1220301-03, 1220301-04, 1220301B00, 1220301B01, 1220301B02, 1220301B03, 1220301B04, 1220301J00, 1220301J01, 1220301J02, 1220301J03, 1220302-00, 1220302-01, 1220302B00, 1220302B01, 1220303-00, 1220303-01, 1220303-02, 1220303-03, 1220303-04, 1220303-05, 1220303A00, 1220303A01, 1220303A02, 1220303A03, 1220303B00, 1220303B01, 1220303B02, 1220303B03, 1220303B04, 1220303B05, 1220303C00, 1220303C01, 1220303C02, 1220303C03, 1220303I00, 1220303I01, 1220303I02, 1220303J01, 1220303J02, 1220303J03, 1220303J04, 1220303K00, 1220303K01, 1220304-00, 1220304-01, 1220304A00... (Other models you can see in the webshop)		



## fittings for catering equipment

### outlet taps

### producer-specific

#### MKN


			
1			
<b>Part No.</b>	520376	<b>Ref. No.</b>	205252
<b>description</b>	drain pipe thread 1/2" ET connection 1/2"		
<b>For models:</b>	0220501-00, 0220502-00, 0220503-00, 0220802-00, 0221501-00, 0221502-00, 0260501-00		


							
1							
<b>Part No.</b>	520378	<b>Ref. No.</b>	201092				
<b>description</b>	outlet tap brass L 100mm thread 1/2" IT - 3/4" IT						
<b>For models:</b>	0220501-00, 0220502-00, 0220503-00, 0220802-00, 0221501-00, 0221502-00, 0260501-00, 0520303-00, 0520303-01, 0520303-02, 1020510-00, 1022603-00, 1220501-00, 1220501-01, 1220501-02, 1220502-00, 1220502-01, 1220802-00, 1220802-01, 1221501-00, 1221501-01, 1221501-02, 1260501-00, 1320501-00, 1320502-00, 1320802-00, 1321501-00, 1321501-01, 1321501-02, 1321501-03, 1360501-00, 1360501-01, 4228801-00, 4228801-01						
<b>accessories for</b>	520378						
	<table border="1"> <tr> <td><b>Part No.</b></td> <td>520376</td> <td><b>Ref. No.</b></td> <td>205252</td> </tr> </table>	<b>Part No.</b>	520376	<b>Ref. No.</b>	205252		
<b>Part No.</b>	520376	<b>Ref. No.</b>	205252				
	 drain pipe thread 1/2" ET connection 1/2"						

### aerators and air bleeders

			
1			
<b>Part No.</b>	540949	<b>Ref. No.</b>	201091
<b>description</b>	aerator and air bleeder thread 1/2" ET chrome-plated with O-ring L 15mm ø 25mm		
<b>For models:</b>	2012801-01, 2012801A01, 2012801B01, 2012801C01, 2012802-01, 2012802A01, 2012802B01, 2012802C01, 2012803-01, 2012803A01, 2012803B01, 2012803C01, 2012804-01, 2012804A01, 2012804B01, 2012804C01, 2012805-01, 2012805A01, 2012805B01, 2012805C01, 2012827-00, 2012827-01, 2012827-02, 2012828-00, 2012828-01, 2012828-02, 2012828-03, 2012828-04, 2012828-05, 2012829-00, 2012829-01, 2012829-02, 2022801-02, 2022801-03, 2022801A02, 2022801A03, 2022801B02, 2022801B03, 2022801C02, 2022801C03, 2022802-02, 2022802-03, 2022802A02, 2022802A03, 2022802B02, 2022802B03, 2022802C02, 2022802C03, 2022803-02, 2022803-03... (Other models you can see in the webshop)		







			
1			
<b>Part No.</b>	541428	<b>Ref. No.</b>	201084
<b>description</b>	aerator and air bleeder thread 3/4" ET chrome-plated L 25mm ø 33mm		
<b>For models:</b>	14228011-0, 14228022-0, 14228033-0, 14228044-0, 14228055-0, 2022801-00, 2022801-01, 20228011-0, 20228011-1, 2022801A00, 2022801A01, 2022801B00, 2022801B01, 2022801C00, 2022802-00, 2022802-01, 20228022-0, 20228022-1, 2022802A00, 2022802A01, 2022802B00, 2022802B01, 2022802C00, 2022802C01, 2022803-00, 2022803-01, 20228033-0, 20228033-1, 2022803A00, 2022803A01, 2022803B00, 2022803B01, 2022803C00, 2022803C01, 2022804-00, 2022804-01, 20228044-0, 20228044-1, 2022804A00, 2022804A01, 2022804B00, 2022804B01, 2022804C00, 2022804C01, 2022805-00, 2022805-01, 20228055-0, 20228055-1, 2022805A00, 2022805A01... (Other models you can see in the webshop)		

			
2			
<b>Part No.</b>	541430	<b>Ref. No.</b>	201736
<b>description</b>	air valve thread 1/2" ET chrome-plated L 16mm ø 25mm		
<b>For models:</b>	1422802B04, 1422802B05, 1422802B06, 1422802B07, 1422802B08, 1422804B04, 1422804B05, 1422804B06, 1422804B07, 1422804B08, 1422805B04, 1422805B05, 1422805B06, 1422805B07, 1422805B08, 1462802B00, 1462802B01, 1462802B02, 1462802B03, 1462802B04, 1462802B05, 1462804B00, 1462804B01, 1462804B02, 1462804B03, 1462804B04, 1462804B05, 1462835-00, 1462836-00, 1462837-00, 1462838-00, 1462839-00, 1462840-00, 2012802B02, 2012802B03, 2012802B04, 2012802B05, 2012802B06, 2012802B07, 2012804B02, 2012804B03, 2012804B04, 2012804B05, 2012804B06, 2012804B07, 2012805B02, 2012805B03, 2012805B04, 2012805B05, 2012805B06... (Other models you can see in the webshop)		

steam valves

			
1			
<b>Part No.</b>	541544	<b>Ref. No.</b>	201052
<b>description</b>	steam valve angled connection 1" IT - 1" ET total length 82mm H 136mm brass		
<b>For models:</b>	1412831-00, 1412832-00, 1412833-00, 1412834-00, 1412908-00, 1412910-00, 2012801-00, 2012801-01, 2012801A00, 2012801A01, 2012801B00, 2012801B01, 2012801C00, 2012801C01, 2012802-00, 2012802-01, 2012802A00, 2012802A01, 2012802B00, 2012802B01, 2012802B02, 2012802B03, 2012802B04, 2012802B05, 2012802B06, 2012802B07, 2012802C00, 2012802C01, 2012803-00, 2012803-01, 2012803A00, 2012803A01, 2012803B00, 2012803B01, 2012803C00, 2012803C01, 2012804-00, 2012804-01, 2012804A00, 2012804A01, 2012804B00, 2012804B01, 2012804B02, 2012804B03, 2012804B04, 2012804B05, 2012804B06, 2012804B07, 2012804C00, 2012804C01... (Other models you can see in the webshop)		
<b>spare parts for</b>	541544		
	<b>Part No.</b>	540229	<b>Ref. No.</b> —
	star handle shaft 9x9mm ø 80mm L 23mm black thermoplastic		



<b>spare parts for</b>	541544		
	<b>Part No.</b>	541546	<b>Ref. No.</b> —
	screw chrome-plated brass thread M5 thread L 10mm		
	<b>Part No.</b>	541548	<b>Ref. No.</b> —
	gasket PTFE ID ø 15mm H 7mm for thread 1 1/4" ED ø 35mm		
	<b>Part No.</b>	541554	<b>Ref. No.</b> —
	gasket copper ext. ø 49 ID ø 42mm H 2mm for thread 1 1/4"		
	<b>Part No.</b>	541557	<b>Ref. No.</b> —
	tap head chrome-plated thread 1 1/4" for steam tap 1"		

lid hinges

type ECHTERMANN


10 series

10.71


			
1			
<b>Part No.</b>	693502	<b>Ref. No.</b>	207175
<b>description</b>	lid hinge type 6910.71 level of centre of rotation 32mm load capacity 10-20NM opening angle 80° closing angle 10° mounting distance 198mm bore ø 11mm MT lid M8mm chrome-plated brass L 270mm		
<b>For models:</b>	14228011-0, 2012801-00, 2012801-01, 2012801A00, 2012801A01, 2022801-00, 2022801-01, 2022801-02, 2022801-03, 20228011-0, 20228011-1, 2022801A00, 2022801A01, 2022801A02, 2022801A03, 2062801-00, 2062801-01, 2062801-02, 2062801-03, 2062801-04, 2062801-05, 2062801-06, 2062801A00, 2062801A01, 2062801A02, 2062801A03, 2062801A04, 2062801A05, 2062801A06, 20628022-0, 20628022-1, 20628022-2, 2112801-00, 2112801-01, 2112801A00, 2112801A01, 2122801-00, 2122801-01, 2122801-02, 2122801-03, 2122801A00, 2122801A01, 2122801A02, 2122801A03, 2122802A00, 3012801-00, 3012801-01, 3012801A00, 3012801A01, 3022801-00... (Other models you can see in the webshop)		
<b>spare parts for</b>	693502		
	<b>Part No.</b>	691611	<b>Ref. No.</b> —
	repair kit for lid hinge load capacity 10-20NM		



10.72			
1			
<b>Part No.</b>	693503	<b>Ref. No.</b>	207170
<b>description</b>	lid hinge type 6910.72 level of centre of rotation 35mm load capacity 10-20NM opening angle 80° closing angle 10° mounting distance 198mm bore ø 11mm MT lid M8mm chrome-plated brass L 270mm		
<b>For models:</b>	14228022-0, 14228033-0, 2012802-00, 2012802-01, 2012802A00, 2012802A01, 2012803-00, 2012803-01, 2012803A00, 2012803A01, 2022802-00, 2022802-01, 2022802-02, 2022802-03, 20228022-0, 20228022-1, 2022802A00, 2022802A01, 2022802A02, 2022802A03, 2022803-00, 2022803-01, 2022803-02, 2022803-03, 20228033-0, 20228033-1, 2022803A00, 2022803A01, 2022803A02, 2022803A03, 2062802-00, 2062802-01, 2062802-02, 2062802-03, 2062802-04, 2062802-05, 2062802-06, 2062802A00, 2062802A01, 2062802A02, 2062802A03, 2062802A04, 2062802A05, 2062802A06, 2062803-00, 2062803-01, 2062803-02, 2062803-03, 2062803-04, 2062803-05... (Other models you can see in the webshop)		

10.73			
1			
<b>Part No.</b>	693504	<b>Ref. No.</b>	207171
<b>description</b>	lid hinge type 6910.73 level of centre of rotation 35mm load capacity 20-30NM opening angle 80° closing angle 10° mounting distance 198mm bore ø 11mm MT lid M8mm chrome-plated brass L 270mm		
<b>For models:</b>	14228044-0, 14228055-0, 2012804-00, 2012804-01, 2012804A00, 2012804A01, 2022804-00, 2022804-01, 2022804-02, 2022804-03, 20228044-0, 20228044-1, 2022804A00, 2022804A01, 2022804A02, 2022804A03, 2022805-00, 2022805-01, 20228055-0, 20228055-1, 2022805A00, 2022805A01, 2062804-00, 2062804-01, 2062804-02, 2062804-03, 2062804-04, 2062804-05, 2062804-06, 20628044-0, 20628044-1, 20628044-2, 2062804A00, 2062804A01, 2062804A02, 2062804A03, 2062804A04, 2062804A05, 2062804A06, 3012804-00, 3012804-01, 3012804A00, 3012804A01, 3012805-00, 3012805-01, 3012805A00, 3012805A01, 3022804-00, 3022804-01, 3022804-02... (Other models you can see in the webshop)		
<b>spare parts for</b>	693504		
	<b>Part No.</b>	691612	<b>Ref. No.</b>
	repair kit for lid hinge load capacity 20-30NM		

12 series			
12.84			
1			
<b>Part No.</b>	693505	<b>Ref. No.</b>	207160
<b>description</b>	lid hinge type 1284 level of centre of rotation 35mm load capacity 10-20NM opening angle 80° closing angle 10° mounting distance 198mm bore ø 11mm MD lid 90mm 26.5 MT lid M8mm chrome-plated brass		
<b>For models:</b>	14228011-0, 14228022-0, 1422802B04, 1422802B05, 1422802B06, 1462802B00, 1462802B01, 1462802B02, 1462802B03, 1462802B04, 1462802B05, 2012801B00, 2012801B01, 2012801C00, 2012801C01, 2012802B00, 2012802B01, 2012802B02, 2012802B03, 2012802B04, 2012802C00, 2012802C01, 2021407-00, 2021407-01, 2021407-02, 2021407-03, 2021407A02, 2021407A03, 2021408-00, 2021408-01, 2021408-02, 2021408A02, 2021417-00, 2021436-00, 2021436-01, 2021436-02, 2021436-03, 2021436A01, 2021436A02, 2021436A03, 2021437-01, 2021437-02, 2021437A00, 2021437A01, 2022801B00, 2022801B01, 2022801B02, 2022801B03, 2022801C00, 2022801C01... (Other models you can see in the webshop)		

1			
<b>Part No.</b>	693506	<b>Ref. No.</b>	207180
<b>description</b>	lid hinge type 1284 level of centre of rotation 35mm load capacity 20-30NM opening angle 80° closing angle 10° mounting distance 198mm bore ø 11mm MD lid 90mm 26.5 MT lid M8mm chrome-plated brass		
<b>For models:</b>	1422705-00, 1422705-01, 1422705-02, 1422706-00, 1422706-01, 1422706-02, 1422707-00, 1422707-01, 1422707-02, 1422708-00, 1422708-01, 1422708-02, 1422804B04, 1422804B05, 1422804B06, 1422805B05, 1422805B06, 1462804B00, 1462804B01, 1462804B02, 1462804B03, 1462804B04, 1462804B05, 2012803B00, 2012803B01, 2012803C00, 2012803C01, 2012804B02, 2012804B03, 2012804B04, 2012805B02, 2012805B03, 2012805B04, 2012806B00, 2012806C00, 2013003B01, 2013003B02, 2013003B03, 2013003B04, 2013003B05, 2013003B06, 2013004B01, 2013004B02, 2013004B03, 2013004B04, 2013004B05, 2021401-09, 2021401A09, 2021402-08, 2021402A08... (Other models you can see in the webshop)		
<b>spare parts for</b>	693506		
	<b>Part No.</b>	691612	<b>Ref. No.</b>
	repair kit for lid hinge load capacity 20-30NM		





<b>Part No.</b>	693507	<b>Ref. No.</b>	207174
<b>description</b>	lid hinge type 1284 level of centre of rotation 35mm load capacity 30-50NM opening angle 80° closing angle 10° mounting distance 198mm bore ø 11mm MD lid 90mm 26.5 MT lid M8mm chrome-plated brass		
<b>For models:</b>	1422701-00, 1422701-01, 1422701-02, 1422701-03, 1422702-00, 1422702-01, 1422702-02, 1422702-03, 1422703-00, 1422703-01, 1422703-02, 1422704-00, 1422704-01, 1422704-02, 14228033-0, 14228044-0, 14228055-0, 1422805B04, 1422807B00, 1422807B01, 1422807B02, 1422807B03, 1422807B04, 1422902-00, 1422902-01, 1422902-02, 1422902-03, 1422902-04, 2012804B00, 2012804B01, 2012804C00, 2012804C01, 2012805-00, 2012805-01, 2012805A00, 2012805A01, 2012805B00, 2012805B01, 2012805C00, 2012805C01, 2012807B00, 2012807B01, 2012807B02, 2012807B03, 2012807B04, 2012807C00, 2012815-00, 2012815-01, 2012901B00, 2012901C00... (Other models you can see in the webshop)		

<b>Part No.</b>	693508	<b>Ref. No.</b>	207015
<b>description</b>	lid hinge type 1284 level of centre of rotation 35mm load capacity 50-60NM opening angle 80° closing angle 10° mounting distance 198mm bore ø 11mm MD lid 90mm 26.5 MT lid M8mm chrome-plated brass		
<b>For models:</b>	2012903-01, 2012903-02, 2012903-03, 2012903-04, 2012909-00, 2012909-01, 2012909-02, 2021401B00, 2021401B01, 2021401B02, 2021401B03, 2021401B04, 2021401B06, 2021401B07, 2021401B08, 2021401B09, 2021401C00, 2021401C01, 2021401C02, 2021401C03, 2021401C04, 2021401C06, 2021401C07, 2021401C08, 2021401C09, 2021402B00, 2021402B01, 2021402B02, 2021402B03, 2021402B04, 2021402B06, 2021402B07, 2021402B08, 2021402C00, 2021402C01, 2021402C02, 2021402C03, 2021402C04, 2021402C06, 2021402C07, 2021402C08, 2021403B04, 2021403B05, 2021403B06, 2021403C04, 2021403C05, 2021403C06, 2021404B04, 2021404B05, 2021404B06... (Other models you can see in the webshop)		
<b>spare parts for</b>	693508		
	<b>Part No.</b>	691614	<b>Ref. No.</b> —
	repair kit for lid hinge load capacity 50-60NM		

drain taps

accessories

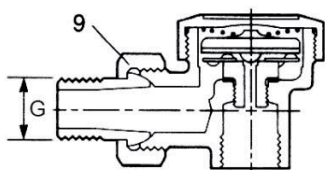
<b>Part No.</b>	541531	<b>Ref. No.</b>	211125
<b>description</b>	repair kit for drain tap 1 1/2" 4x O-ring + fitting grease		
<b>For models:</b>	1422802B06, 1422802B07, 1422802B08, 1422804B06, 1422804B07, 1422804B08, 1422805B06, 1422805B07, 1422805B08, 1422807B03, 1422807B04, 1422902-03, 1422902-04, 1462802B03, 1462804B03, 2012802B05, 2012802B06, 2012802B07, 2012804B05, 2012804B06, 2012804B07, 2012805B05, 2012805B06, 2012805B07, 2012807B03, 2012807B04, 2012812-00, 2012812-01, 2012812-02, 2012813-00, 2012813-01, 2012813-02, 2012813-03, 2012814-00, 2012814-01, 2012814-02, 2012814-03, 2012815-00, 2012902-02, 2012902-03, 2012903-01, 2012903-02, 2012903-03, 2012907-00, 2012907-01, 2012907-02, 2012909-01, 2013003B04, 2013003B05, 2013003B06... (Other models you can see in the webshop)		

<b>Part No.</b>	541532	<b>Ref. No.</b>	211126
<b>description</b>	repair kit for drain tap 2" 4x O-ring + fitting grease		
<b>For models:</b>	1422701-02, 1422701-03, 1422702-02, 1422702-03, 1422703-01, 1422703-02, 1422704-01, 1422704-02, 1422705-01, 1422705-02, 1422706-01, 1422706-02, 1422707-01, 1422707-02, 1422708-01, 1422708-02, 1423901-00, 1423901-01, 1423901-02, 1423902-00, 1423902-01, 1423902-02, 1423903-00, 1423903-01, 1423903-02, 1424101-01, 1424102-01, 1424103-00, 1424104-00, 2012903-04, 2012909-02, 2013901-00, 2013901-01, 2013901-02, 2013901-03, 2013902-00, 2013902-01, 2013902-02, 2013902-03, 2013903-00, 2013903-01, 2013903-02, 2013903-03, 2022701-03, 2022701-04, 2022703-03, 2022703-04, 2022705-03, 2022705-04, 2022707-03... (Other models you can see in the webshop)		



steam traps

steam traps

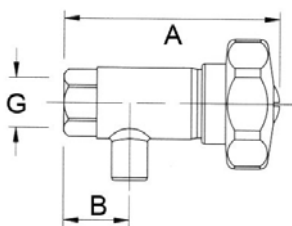


1

<b>Part No.</b>	540243	<b>Ref. No.</b>	201734
<b>description</b>	thermostatic steam trap thread 1/2" type BPT13UA brass		
<b>For models:</b>	1412831-00, 1412832-00, 1412833-00, 1412833-01, 1412834-00, 1412834-01, 1412908-00, 1412910-00, 1412910-01, 1422802B04, 1422802B05, 1422802B06, 1422802B07, 1422802B08, 1422804B04, 1422804B05, 1422804B06, 1422804B07, 1422804B08, 1422805B04, 1422805B05, 1422805B06, 1422805B07, 1422805B08, 1422807B00, 1422807B01, 1422807B02, 1422807B03, 1422807B04, 1422831-00, 1422832-00, 1422833-00, 1422834-00, 1422902-00, 1422902-01, 1422902-02, 1422902-03, 1422902-04, 1422908-00, 1422910-00, 1423901-00, 1423901-01, 1423901-02, 1423902-00, 1423902-01, 1423902-02, 1423903-00, 1423903-01, 1423903-02, 1462802B00... (Other models you can see in the webshop)		

test taps

test taps



1

<b>Part No.</b>	514277	<b>Ref. No.</b>	201051
<b>description</b>	test tap thread 3/8" IT W 70mm W1 25mm		
<b>For models:</b>	14228011-0, 14228022-0, 14228033-0, 14228044-0, 14228055-0, 2022801-00, 2022801-01, 20228011-0, 20228011-1, 2022801A00, 2022801A01, 2022801B00, 2022801B01, 2022801C00, 2022801C01, 2022802-00, 2022802-01, 20228022-0, 20228022-1, 2022802A00, 2022802A01, 2022802B00, 2022802B01, 2022802C00, 2022802C01, 2022803-00, 2022803-01, 20228033-0, 20228033-1, 2022803A00, 2022803A01, 2022803B00, 2022803B01, 2022803C00, 2022803C01, 2022804-00, 2022804-01, 20228044-0, 20228044-1, 2022804A00, 2022804A01, 2022804B00, 2022804B01, 2022804C00, 2022804C01, 2022805-00, 2022805-01, 20228055-0, 20228055-1, 2022805A00... (Other models you can see in the webshop)		

safety fittings

safety fittings



1

<b>Part No.</b>	514328	<b>Ref. No.</b>	201050	
<b>description</b>	safety fitting thread 1" 0.4bar 130kg/h thread size manometer 1/4"-1/2" chrome-plated H 200mm W 180mm			
<b>spare parts for</b>	514328			
	<b>Part No.</b>	540320	<b>Ref. No.</b>	—
	ball handle thread M5 ø 20mm with metal bush			
	<b>Part No.</b>	540322	<b>Ref. No.</b>	—
	ball handle thread M8 ø 32mm with metal bush			
	<b>Part No.</b>	540926	<b>Ref. No.</b>	—
	filling funnel thread 3/8" for safety fitting			
	<b>Part No.</b>	540949	<b>Ref. No.</b>	201091
	aerator and air bleeder thread 1/2" ET chrome-plated with O-ring L 15mm ø 25mm			
<b>accessories for</b>	514328			
	<b>Part No.</b>	541062	<b>Ref. No.</b>	201105
	manometer ø 63mm pressure range 0 up to 1bar connection marking adjustable kettle thread 1/4"			

safety valves




1

<b>Part No.</b>	541436	<b>Ref. No.</b>	201044
<b>description</b>	safety valve thread 3/4"		
<b>For models:</b>	14228011-0, 14228022-0, 14228033-0, 14228044-0, 14228055-0, 2012801-00, 2012801-01, 2012801A00, 2012801A01, 2012801B00, 2012801B01, 2012801C00, 2012801C01, 2012802-00, 2012802-01, 2012802A00, 2012802A01, 2012802B00, 2012802B01, 2012802C00, 2012802C01, 2012803-00, 2012803-01, 2012803A00, 2012803A01, 2012803B00, 2012803B01, 2012803C00, 2012803C01, 2012804-00, 2012804-01, 2012804A00, 2012804A01, 2012804B00, 2012804B01, 2012804C00, 2012804C01, 2012805-00, 2012805-01, 2012805A00, 2012805A01, 2012805B00, 2012805B01, 2012805C00, 2012805C01, 2012806B00, 2012806C00, 2012807B00, 2012807C00, 2012901B00... (Other models you can see in the webshop)		

mechanical components, equipment accessories

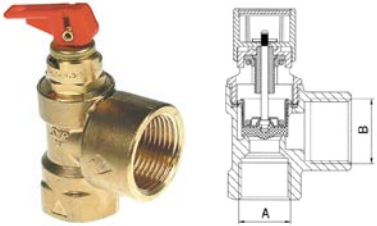


mechanical components, equipment accessories



1

<b>Part No.</b>	518668	<b>Ref. No.</b>	211124
<b>description</b>	gasket set EPDM ID ø 24/38/52/63mm for safety valve		
<b>For models:</b>	1423901-00, 1423901-01, 1423901-02, 1423902-00, 1423902-01, 1423902-02, 1423903-00, 1423903-01, 1423903-02, 1424101-01, 1424102-01, 1424103-00, 1424104-00, 2013901-00, 2013901-01, 2013901-02, 2013901-03, 2013902-00, 2013902-01, 2013902-02, 2013902-03, 2013903-00, 2013903-01, 2013903-02, 2013903-03, 2023901-00, 2023901-01, 2023901-02, 2023901-03, 2023902-00, 2023902-01, 2023902-02, 2023903-00, 2023903-01, 2023903-02, 2024101-01, 2024102-01, 2024103-01, 2024104-01, 2024201-04, 2024202-01, 2024203-04, 2024204-01, 2024205-01, 2024206-00, 2024207-01, 2024208-00, 3023901-03, 3023902-00, 3023902-01... (Other models you can see in the webshop)		



1


<b>Part No.</b>	541431	<b>Ref. No.</b>	201730
<b>description</b>	safety valve T1: 3/4" T2: 1" triggering pressure 1bar		
<b>For models:</b>	1412831-00, 1412832-00, 1412833-00, 1412833-01, 1412834-00, 1412834-01, 1412908-00, 1412910-00, 1412910-01, 1422802B04, 1422802B05, 1422802B06, 1422802B07, 1422802B08, 1422804B04, 1422804B05, 1422804B06, 1422804B07, 1422804B08, 1422805B04, 1422805B05, 1422805B06, 1422805B07, 1422805B08, 1422807B00, 1422807B01, 1422807B02, 1422807B03, 1422807B04, 1422831-00, 1422832-00, 1422833-00, 1422834-00, 1422902-00, 1422902-01, 1422902-02, 1422902-03, 1422902-04, 1422908-00, 1422910-00, 1462802B00, 1462802B01, 1462802B02, 1462802B03, 1462802B04, 1462802B05, 1462804B00, 1462804B01, 1462804B02, 1462804B03... (Other models you can see in the webshop)		

## equipment feet and end caps

### equipment feet

### with screw mounting

### universal




1

<b>Part No.</b>	701646	<b>Ref. No.</b>	204561
<b>description</b>	equipment foot tube ø 64mm thread M10x1.5 thread L 17mm H 100-135mm SS Qty 1 pcs		
<b>For models:</b>	CGE11-L, CGE11-R, CGE12-L, CGE12-R, CGE61-L, CGE61-R, CGE62-L, CGE62-R, CGG11-L, CGG11-R, CGG12-L, CGG12-R, CGG61-L, CGG61-R, CGG62-L, CGG62-R, CSE11-L, CSE11-R, CSE11-R-DG, CSE12-L, CSE12-R, CSE12-R-DG, CSE61-L, CSE61-R, CSE61-R-DG, CSE62-L, CSE62-R, CSE62-R-DG, CSG11-L, CSG11-R, CSG11-R-DG, CSG12-L, CSG12-R, CSG12-R-DG, CSG61-L, CSG61-R, CSG61-R-DG, CSG62-L, CSG62-R, CSG62-R-DG		

## baskets


### fryer baskets

#### MKN




1

<b>Part No.</b>	970735	<b>Ref. No.</b>	206008
<b>description</b>	fryer basket W1 135mm L1 176mm H1 114mm L2 375mm H3 180mm chrome-plated steel		
<b>For models:</b>	0520302-00, 0520302-01, 0520302-02, 0520302A00, 0520302A01		




1

<b>Part No.</b>	970152	<b>Ref. No.</b>	206129
<b>description</b>	fryer basket W1 160mm L1 310mm H1 115mm chrome-plated steel		
<b>For models:</b>	0220301-00, 0220301B00, 0220301B01, 0220301B02, 0220301D00, 0220302-00, 0220302A00, 0220302A01, 0220302A02, 0220302A03, 0220302B00, 0220302B01, 0220302B02, 0220302C00, 0220302C01, 0220302C02, 0220302C03, 0220302D00, 0220302E00, 0220302E01, 0220302F00, 0220302H00, 0220302H01, 0220303-00, 0220303-01, 0220303A00, 0220303A01, 0220303A02, 0220303A03, 0220303B00, 0220303B01, 0220303C00, 0220303C01, 0220303C02, 0220303D00, 0220303D01, 0220303E00, 0220303E01, 0220303H00, 0220303H01, 0220304-00, 0220305-00, 0220306-00, 0260301-00, 0260301-01, 0260302-00, 0260302-01, 0720325-03, 0720325-04, 0720325B03... (Other models you can see in the webshop)		



1


<b>Part No.</b>	970293	<b>Ref. No.</b>	206000
<b>description</b>	fryer basket W1 205mm L1 240mm H1 110mm		
<b>For models:</b>	1820301-00, 1820301-01, 1820301-02		

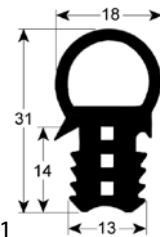


1

<b>Part No.</b>	970464	<b>Ref. No.</b>	206130
<b>description</b>	fryer basket W1 343mm L1 368mm H1 114mm L2 392mm H2 133mm H3 243mm chrome-plated steel gas fryer		
<b>For models:</b>	0260302-00, 0260302-01, 1260302-00, 1260302-01, 1460302-00, 1460302-01, 1460302-02, 2060301-00, 2060301-01, 2060301-02		



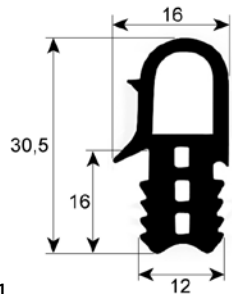
			
<b>Part No.</b>	970414	<b>Ref. No.</b>	206020
<b>description</b>	fryer basket W1 380mm L1 345mm H1 100mm H2 130mm H3 230mm chrome-plated steel electric fryer		
<b>For models:</b>	0220303-00, 0220303-01, 0220303A00, 0220303A01, 0220303A02, 0220303A03, 0220303B00, 0220303B01, 0220303C00, 0220303C01, 0220303C02, 0220303D00, 0220303D01, 0220303E00, 0220303E01, 0220303H00, 0220303H01, 0220306-00, 1220305-00, 1220305-01, 1220305-02, 1220305-03, 1220305-04, 1220305-05, 1220305-06, 1220305-07, 1220305A00, 1220305A01, 1220305A02, 1220305A03, 1220305A04, 1220305A05, 1220305B00, 1220305B01, 1220305B02, 1220305B03, 1220305B04, 1220305B05, 1220305B06, 1220305B07, 1220305C00, 1220305C01, 1220305C02, 1220305C03, 1220305C04, 1220305C05, 1220305D00, 1220305D01, 1220305D02, 1220305D03... (Other models you can see in the webshop)		

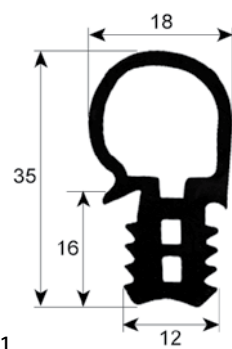
			
<b>Part No.</b>	902213	<b>Ref. No.</b>	10012490
<b>description</b>	door seal profile 2064 W 600mm L 740mm outer plug size		
<b>For models:</b>	CGE11-L, CGE11-R, CGE12-L, CGE12-R, CGG11-L, CGG11-R, CGG12-L, CGG12-R, CSE11-L, CSE11-R, CSE11-R-DG, CSE12-L, CSE12-R, CSE12-R-DG, CSG11-L, CSG11-R, CSG11-R-DG, CSG12-L, CSG12-R, CSG12-R-DG		


## gaskets

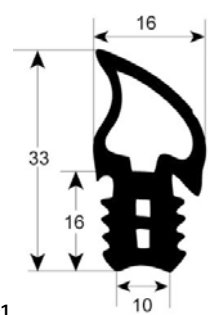
### gaskets for heated units

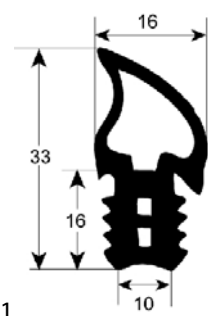
#### door seals

			
<b>Part No.</b>	901456	<b>Ref. No.</b>	211112
<b>description</b>	door seal profile 2063 perimeter 1540mm Qty 1		
<b>For models:</b>	CCE60, CCE63, CPE60, CPE63		

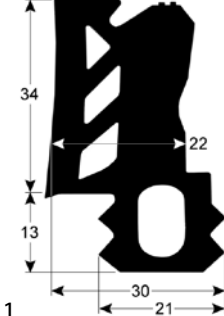
			
<b>Part No.</b>	900793	<b>Ref. No.</b>	211096
<b>description</b>	door seal profile 2065 W 605mm L 1480mm external size Qty 1		
<b>For models:</b>	CGE21-L, CGE21-R, CGE22-L, CGE22-R, CGG21-L, CGG21-R, CGG22-L, CGG22-R, CSE21-L, CSE21-R, CSE21-R-DG, CSE22-L, CSE22-R, CSE22-R-DG, CSG21-L, CSG21-R, CSG21-R-DG, CSG22-L, CSG22-R, CSG22-R-DG		

			
<b>Part No.</b>	902501	<b>Ref. No.</b>	10012489
<b>description</b>	door seal profile 2064 W 472mm L 600mm outer plug size suitable for MKN		
<b>For models:</b>	CGE61-L, CGE61-R, CGE62-L, CGE62-R, CGG61-L, CGG61-R, CGG62-L, CGG62-R, CSE61-L, CSE61-R, CSE61-R-DG, CSE62-L, CSE62-R, CSE62-R-DG, CSG61-L, CSG61-R, CSG61-R-DG, CSG62-L, CSG62-R, CSG62-R-DG		

			
<b>Part No.</b>	900783	<b>Ref. No.</b>	211094
<b>description</b>	door seal profile 2743 W 480mm L 610mm external size Qty 1		
<b>For models:</b>	CGE61-L, CGE61-R, CGE62-L, CGE62-R, CGG61-L, CGG61-R, CGG62-L, CGG62-R, CSE61-L, CSE61-R, CSE61-R-DG, CSE62-L, CSE62-R, CSE62-R-DG, CSG61-L, CSG61-R, CSG61-R-DG, CSG62-L, CSG62-R, CSG62-R-DG		





<b>Part No.</b>	900784	<b>Ref. No.</b>	211095
<b>description</b>	door seal profile 2743 W 610mm L 750mm external size Qty 1		
<b>For models:</b>	CGE11-L, CGE11-R, CGE12-L, CGE12-R, CGG11-L, CGG11-R, CGG12-L, CGG12-R, CSE11-L, CSE11-R, CSE11-R-DG, CSE12-L, CSE12-R, CSE12-R-DG, CSG11-L, CSG11-R, CSG11-R-DG, CSG12-L, CSG12-R, CSG12-R-DG		

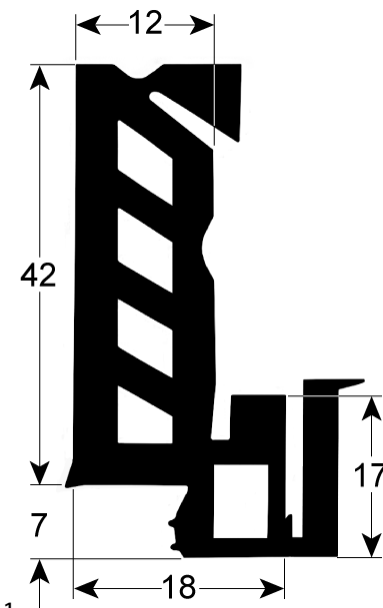


<b>Part No.</b>	902499	<b>Ref. No.</b>	211171
<b>description</b>	tray rack trolley gasket profile 4120 L 630mm Qty 1		
<b>For models:</b>	CGE21-L, CGE21-R, CGE22-L, CGE22-R, CGG21-L, CGG21-R, CGG22-L, CGG22-R, CSE21-L, CSE21-R, CSE22-L, CSE22-R, CSG21-L, CSG21-R, CSG22-L, CSG22-R		

## door seals with fixing hook




<b>Part No.</b>	900512	<b>Ref. No.</b>	211063
<b>description</b>	door seal L 525mm W 270mm 3-sided long side open with 5 mounting clips		
<b>For models:</b>	0522101-04, 0522102-04, 0722101-06, 1323208-04, 1323210-03, 1323210-04, 1323403-00, 1323403K00, 1323506-00, 1323506-01, 1323506A00, 1323506A01, 1323517-00, 1323517A00, 1363403-03, 1363403-04, 1363403-05, 1363415-05, 1422101-04, 1422101-05, 1422101-06, 1422102-04, 1422102-05, 1422301-01, 2023114-00, 2023118-00, 2023119-00, 2023203-07, 2023205-07, 2023207-03, 2023207-04, 2023207-05, 2023406-00, 2023503-10, 2023503-11, 2023503-12, 2023503-13, 2023503A10, 2023503A11, 2023503A12, 2023503A13, 2063403-08, 2063403-09, 2063403-10, 2063406-08, 2063406-09, 2063406-10, 2063415-05, 2063418-05, 2063502-08... (Other models you can see in the webshop)		




<b>Part No.</b>	902500	<b>Ref. No.</b>	211156
<b>description</b>	tray rack trolley gasket profile 4130 L 654mm Qty 1		
<b>For models:</b>	CSE21-R-DG, CSE22-R-DG, CSG21-R-DG, CSG22-R-DG		

## gaskets for tray rack trolleys




<b>Part No.</b>	901157	<b>Ref. No.</b>	211104
<b>description</b>	tray rack trolley gasket profile 4075 L 645mm		
<b>For models:</b>	CGE21-L, CGE21-R, CGE22-L, CGE22-R, CGG21-L, CGG21-R, CGG22-L, CGG22-R, CSE21-L, CSE21-R, CSE22-L, CSE22-R, CSG21-L, CSG21-R, CSG22-L, CSG22-R		

## gaskets for control panels




<b>Part No.</b>	902484	<b>Ref. No.</b>	211089
<b>description</b>	gasket for control panel W 220mm L 1420mm suitable for MKN combi-steamer with 10 mounting clips model HD20.x		
<b>For models:</b>	CGE21-L, CGE21-R, CGE22-L, CGE22-R, CGG21-L, CGG21-R, CGG22-L, CGG22-R, CSE21-L, CSE21-R, CSE21-R-DG, CSE22-L, CSE22-R, CSE22-R-DG, CSG21-L, CSG21-R, CSG21-R-DG, CSG22-L, CSG22-R, CSG22-R-DG		



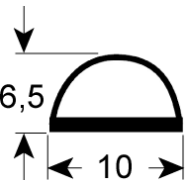
<b>Part No.</b>	902447	<b>Ref. No.</b>	211087
<b>description</b>	gasket for cover L 1580mm suitable for MKN for combi-steamer with 6 mounting clips		
<b>For models:</b>	CGE61-L, CGE61-R, CGE62-L, CGE62-R, CGG61-L, CGG61-R, CGG62-L, CGG62-R, CSE61-L, CSE61-R, CSE61-R-DG, CSE62-L, CSE62-R, CSE62-R-DG, CSG61-L, CSG61-R, CSG61-R-DG, CSG62-L, CSG62-R, CSG62-R-DG		



<b>Part No.</b>	902448	<b>Ref. No.</b>	211088
<b>description</b>	gasket for cover L 2040mm suitable for MKN for combi-steamer with 6 mounting clips		
<b>For models:</b>	CGE11-L, CGE11-R, CGE12-L, CGE12-R, CGG11-L, CGG11-R, CGG12-L, CGG12-R, CSE11-L, CSE11-R, CSE11-R-DG, CSE12-L, CSE12-R, CSE12-R-DG, CSG11-L, CSG11-R, CSG11-R-DG, CSG12-L, CSG12-R, CSG12-R-DG		

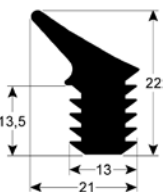
**miscellaneous**

**miscellaneous**



<b>Part No.</b>	902485	<b>Ref. No.</b>	211090
<b>description</b>	lid gasket profile 10x6.5 L 1075mm combi-steamer self-adhesive mounting pos. casing cover suitable for MKN		
<b>For models:</b>	CGE11-L, CGE11-R, CGE12-L, CGE12-R, CGE21-L, CGE21-R, CGE22-L, CGE22-R, CGE61-L, CGE61-R, CGE62-L, CGE62-R, CGG11-L, CGG11-R, CGG12-L, CGG12-R, CGG21-L, CGG21-R, CGG22-L, CGG22-R, CGG61-L, CGG61-R, CGG62-L, CGG62-R, CSE11-L, CSE11-R, CSE11-R-DG, CSE12-L, CSE12-R, CSE12-R-DG, CSE21-L, CSE21-R, CSE21-R-DG, CSE22-L, CSE22-R, CSE22-R-DG, CSE61-L, CSE61-R, CSE61-R-DG, CSE62-L, CSE62-R, CSE62-R-DG, CSG11-L, CSG11-R, CSG11-R-DG, CSG12-L, CSG12-R, CSG12-R-DG, CSG21-L, CSG21-R...(Other models you can see in the webshop)		

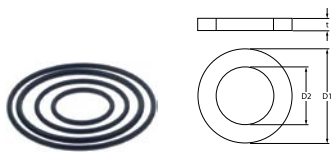
**lid gaskets**



<b>Part No.</b>	902503	<b>Ref. No.</b>	10011826
<b>description</b>	gasket for lid profile 2719 W 685mm L 1098mm outer plug size suitable for MKN Qty 1		

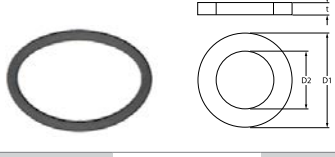
**O-rings**

**EPDM**




<b>Part No.</b>	518668	<b>Ref. No.</b>	211124
<b>description</b>	gasket set EPDM ID $\varnothing$ 24/38/52/63mm for safety valve		
<b>For models:</b>	1423901-00, 1423901-01, 1423901-02, 1423902-00, 1423902-01, 1423902-02, 1423903-00, 1423903-01, 1423903-02, 1424101-01, 1424102-01, 1424103-00, 1424104-00, 2013901-00, 2013901-01, 2013901-02, 2013901-03, 2013902-00, 2013902-01, 2013902-02, 2013902-03, 2013903-00, 2013903-01, 2013903-02, 2013903-03, 2023901-00, 2023901-01, 2023901-02, 2023901-03, 2023902-00, 2023902-01, 2023902-02, 2023903-00, 2023903-01, 2023903-02, 2024101-01, 2024102-01, 2024103-01, 2024104-01, 2024201-04, 2024202-01, 2024203-04, 2024204-01, 2024205-01, 2024206-00, 2024207-01, 2024208-00, 3023901-03, 3023902-00, 3023902-01... (Other models you can see in the webshop)		

**Viton**



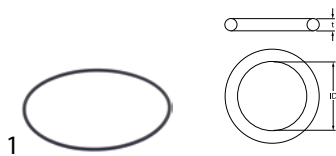
<b>Part No.</b>	104212	<b>Ref. No.</b>	211018
<b>description</b>	O-ring Viton thickness 3mm ID $\varnothing$ 32.5mm Qty 1 pcs		
<b>For models:</b>	0263401-00, 0263401-01, 1220501-00, 1220501-01, 1220501-02, 1220502-00, 1220502-01, 1220802-00, 1220802-01, 1222507-00, 1222509-00, 1263401-00, 1263402-00, 1263402-01, 1263402-02, 1263404-00, 1263404-01, 1263404-02, 1263413-02, 1263414-02, 1320501-00, 1320502-00, 1320802-00, 1322507-00, 1322509-00, 1363401-00, 1363402-00, 1363402-01, 1363402-02, 1363403-00, 1363403-01, 1363403-02, 1363403-03, 1363403-04, 1363403-05, 1363404-00, 1363404-01, 1363404-02, 1363404-03, 1363413-03, 1363415-05, 1422513B00, 1422513B01, 1422515B01, 1422515B02, 1422701-00, 1422701-01, 1422701-02, 1422701-03, 1422702-00... (Other models you can see in the webshop)		



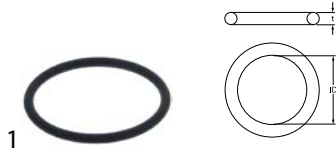
<b>Part No.</b>	532733	<b>Ref. No.</b>	211086
<b>description</b>	O-ring Viton thickness 5mm ID $\varnothing$ 65mm Qty 1 pcs		
<b>For models:</b>	CGE11-L, CGE11-R, CGE12-L, CGE12-R, CGE21-L, CGE21-R, CGE22-L, CGE22-R, CGE61-L, CGE61-R, CGE62-L, CGE62-R, CGG11-L, CGG11-R, CGG12-L, CGG12-R, CGG21-L, CGG21-R, CGG22-L, CGG22-R, CGG61-L, CGG61-R, CGG62-L, CGG62-R, CSE11-L, CSE11-R, CSE11-R-DG, CSE12-L, CSE12-R, CSE12-R-DG, CSE21-L, CSE21-R, CSE21-R-DG, CSE22-L, CSE22-R, CSE22-R-DG, CSE61-L, CSE61-R, CSE61-R-DG, CSE62-L, CSE62-R, CSE62-R-DG, CSG11-L, CSG11-R, CSG11-R-DG, CSG12-L, CSG12-R, CSG21-L, CSG21-R, CSG21-R-DG...(Other models you can see in the webshop)		



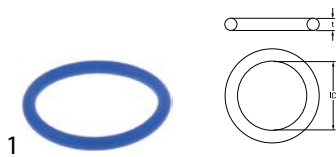
## miscellaneous



<b>Part No.</b>	519627	<b>Ref. No.</b>	10010994
<b>description</b>	O-ring thickness 1.5mm ID ø 56mm Qty 1 pcs suitable for MKN		



<b>Part No.</b>	519628	<b>Ref. No.</b>	10014116
<b>description</b>	O-ring thickness 3.5mm ID ø 45mm Qty 1 pcs suitable for MKN		



<b>Part No.</b>	532734	<b>Ref. No.</b>	211116
<b>description</b>	O-ring thickness 5mm ID ø 45mm for outflow plug blue		
<b>For models:</b>	1222507-00, 1222509-00, 1322507-00, 1322509-00, 1422513B00, 1422513B01, 1422515B01, 1422515B02, 1422701-02, 1422701-03, 1422702-02, 1422702-03, 1422703-01, 1422703-02, 1422704-01, 1422704-02, 1422705-01, 1422705-02, 1422706-01, 1422706-02, 1422707-01, 1422707-02, 1422708-01, 1422708-02, 1424101-01, 1424102-01, 1424103-00, 1424104-00, 1522507-00, 1522507-01, 1522509-00, 1522509-01, 2022509-00, 2022513-00, 2022701-02, 2022701-03, 2022701-04, 2022703-01, 2022703-03, 2022703-04, 2022705-02, 2022705-03, 2022705-04, 2022707-01, 2022707-03, 2022707-04, 2024101-01, 2024102-01, 2024103-01, 2024104-01... (Other models you can see in the webshop)		

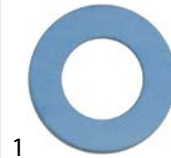
## sealing washers

## aluminium gaskets



<b>Part No.</b>	560307	<b>Ref. No.</b>	214006
<b>description</b>	flat gasket aluminium ED ø 21mm ID ø 17mm thickness 1.5mm Qty 1 pcs		
<b>For models:</b>	2013003B04, 2013003B05, 2013003B06, 2013007B04, 2013007B05, 2013007B06, 2013009B04, 2013009B05, 2013009B06, 2013017B03, 2013017B04, 2013017B05, 2021401-09, 2021401A09, 2021401B09, 2021401C09, 2021407-03, 2021407A03, 2021407B03, 2021407C03, 2021409-02, 2021409B02, 2021430-01, 2021430-02, 2021430A01, 2021430A02, 2021430B02, 2021430B03, 2021430C02, 2021430C03, 2021436-02, 2021436-03, 2021436A02, 2021436A03, 2021436B02, 2021436B03, 2021436C02, 2021436C03, 2021440-04, 2021440-05, 2021440A04, 2021440A05, 2021440B04, 2021440B05, 2021440C04, 2021440C05, 2021441-04, 2021441-05, 2021441-06, 2021441-07... (Other models you can see in the webshop)		

## fibre gaskets



<b>Part No.</b>	540071	<b>Ref. No.</b>	214001
<b>description</b>	flat gasket FIBER ED ø 18mm ID ø 10mm thickness 2mm Qty 1 pcs		
<b>For models:</b>	1423901-00, 1423901-01, 1423901-02, 1423902-00, 1423902-01, 1423902-02, 1423903-00, 1423903-01, 1423903-02, 1424101-00, 1424101-01, 1424102-00, 1424102-01, 1424103-00, 1424104-00, 2013901-00, 2013901-01, 2013901-02, 2013901-03, 2013902-00, 2013902-01, 2013902-02, 2013902-03, 2013903-00, 2013903-01, 2013903-02, 2013903-03, 2020406A01, 2023901-00, 2023901-01, 2023901-02, 2023901-03, 2023902-00, 2023902-01, 2023902-02, 2023903-00, 2023903-01, 2023903-02, 2024101-00, 2024101-01, 2024102-00, 2024102-01, 2024103-00, 2024103-01, 2024104-00, 2024104-01, 2024201-00, 2024201-01, 2024201-02, 2024201-03... (Other models you can see in the webshop)		

## graphite gaskets



<b>Part No.</b>	691609	<b>Ref. No.</b>	211143
<b>description</b>	gasket graphite ED ø 150mm ID ø 115mm thickness 2mm Qty 1 pcs		
<b>For models:</b>	CGG11-L, CGG11-R, CGG12-L, CGG12-R, CGG21-L, CGG21-R, CGG22-L, CGG22-R, CGG61-L, CGG61-R, CGG62-L, CGG62-R, CSG11-L, CSG11-R, CSG11-R-DG, CSG12-L, CSG12-R, CSG12-R-DG, CSG21-L, CSG21-R, CSG21-R-DG, CSG22-L, CSG22-R, CSG22-R-DG, CSG61-L, CSG61-R, CSG61-R-DG, CSG62-L, CSG62-R, CSG62-R-DG		

## rubber gaskets




<b>Part No.</b>	512514	<b>Ref. No.</b>	211139
<b>description</b>	flat gasket rubber ED ø 19mm ID ø 8mm thickness 2mm for combi-steamer Qty 1 pcs		
<b>For models:</b>	CGE11-L, CGE11-R, CGE12-L, CGE12-R, CGE21-L, CGE21-R, CGE22-L, CGE22-R, CGE61-L, CGE61-R, CGE62-L, CGE62-R, CGG11-L, CGG11-R, CGG12-L, CGG12-R, CGG21-L, CGG21-R, CGG22-L, CGG22-R, CGG61-L, CGG61-R, CGG62-L, CGG62-R, CSE11-L, CSE11-R, CSE11-R-DG, CSE12-L, CSE12-R, CSE12-R-DG, CSE21-L, CSE21-R, CSE21-R-DG, CSE22-L, CSE22-R, CSE22-R-DG, CSE61-L, CSE61-R, CSE61-R-DG, CSE62-L, CSE62-R, CSE62-R-DG, CSG11-L, CSG11-R, CSG11-R-DG, CSG12-L, CSG12-R, CSG12-R-DG, CSG21-L, CSG21-R... (Other models you can see in the webshop)		



copper gaskets


DIN-7603-C



1

Part No.	528520	Ref. No.	211004
description	gasket copper ED ø 22mm ID ø 16mm thickness 2mm		
For models:	1223212-00, 1261101-00, 1261101-01, 1261101-02, 1261102-00, 1261102-01, 1261102-02, 1361101-00, 1361101-01, 1361101-02, 1361101-03, 1361102-00, 1361102-01, 1361102-02, 1361102-03, 1461101-01, 1461101-02, 1461101-03, 1461102-01, 1461102-02, 1461102-03, 1461104-01, 1461104-02, 1461104-03, 1461105-01, 1461105-02, 1461105-03, 1461109-01, 1461109-02, 1461109A01, 1461109A02, 1462802B00, 1462804B00, 1463501-03, 1463501-04, 1463501-05, 1561110-00, 2061101-01, 2061101-02, 2061101-03, 2061101-04, 2061101-05, 2061102-01, 2061102-02, 2061102-03, 2061102-04, 2061102-05, 2061103-04, 2061107-00, 2061107-01... (Other models you can see in the webshop)		

PTFE gaskets




1

Part No.	507588	Ref. No.	10011097
description	flat gasket PTFE ED ø 14mm ID ø 10mm thickness 1mm Qty 1 pcs suitable for		
For models:	CGE11-L, CGE11-R, CGE12-L, CGE12-R, CGE21-L, CGE21-R, CGE22-L, CGE22-R, CGE61-L, CGE61-R, CGE62-L, CGE62-R, CGG11-L, CGG11-R, CGG12-L, CGG12-R, CGG21-L, CGG21-R, CGG22-L, CGG22-R, CGG61-L, CGG61-R, CGG62-L, CGG62-R, CSE11-L, CSE11-R, CSE11-R-DG, CSE12-L, CSE12-R, CSE12-R-DG, CSE61-L, CSE61-R, CSE61-R-DG, CSE62-L, CSE62-R, CSE62-R-DG, CSG11-L, CSG11-R, CSG11-R-DG, CSG12-L, CSG12-R, CSG12-R-DG, CSG21-L, CSG21-R, CSG21-R-DG, CSG22-L, CSG22-R, CSG22-R-DG, CSG61-L, CSG61-R...(Other models you can see in the webshop)		


sealing cords

round



1

Part No.	693464	Ref. No.	211047
description	sealing cord ø 10mm Qty supplied by meter		
For models:	1424802-00, 1424802-01, 1424802-02, 1424808-01, 1424808-02, 1424808-03, 1424809-01, 1424809-02, 1424811-01, 1424811-02, 1424811-03, 1424812-01, 1424812-02, 1424813-01, 1424813-02, 2023201-01, 2023201-02, 2023201-03, 2023201A01, 2023202-01, 2023202-02, 2023202A01, 2023203-02, 2023203-03, 2023203-04, 2023203-05, 2023203-06, 2023203-07, 2023203A02, 2023203A03, 2023204-01, 2023204-02, 2023204A01, 2023205-02, 2023205-03, 2023205-04, 2023205-05, 2023205-06, 2023205-07, 2023205A02, 2023205A03, 2083201A01, 2083202A02, 2083202A03, 2123201-01, 2123201-02, 2123201-03, 2123201-04, 2123202-01, 2123202-02... (Other models you can see in the webshop)		




1

Part No.	693451	Ref. No.	211031
description	sealing cord ø 8mm Qty supplied by meter		
For models:	1223215-00, 1223215A00, 1223216-00, 1223216A00, 1223504A00, 1223504A01, 1223505-00, 1223505-01, 1223505A00, 1223505A01, 1323504-00, 1323504-01, 1323504A00, 1323504A01, 1323505-00, 1323505-01, 1323505A00, 1323505A01, 1323506-00, 1323506-01, 1323506A00, 1323506A01, 1323515-00, 1323515A00, 1323516-00, 1323516A00, 1323517-00, 1323517A00, 1423501-00, 1423501-01, 1423501A00, 1423501A01, 1423502-00, 1423502-01, 1423502-02, 1423502A00, 1423502A01, 1423502A02, 1423504-00, 1423504-01, 1423504A00, 1423504A01, 1423505-00, 1423505-01, 1423505A00, 1423505A01, 1423507A00, 1423508A00, 1423510A00, 1423511A00... (Other models you can see in the webshop)		

shaft gaskets

miscellaneous



1

Part No.	691513	Ref. No.	211084
description	shaft seal ID ø 16.5mm ED ø 29mm thickness 4.8mm		
For models:	CCE60, CGE11-L, CGE11-R, CGE12-L, CGE12-R, CGE21-L, CGE21-R, CGE22-L, CGE22-R, CGE61-L, CGE61-R, CGE62-L, CGE62-R, CGG11-L, CGG11-R, CGG12-L, CGG12-R, CGG21-L, CGG21-R, CGG22-L, CGG22-R, CGG61-L, CGG61-R, CGG62-L, CGG62-R, CPE60, CSE11-L, CSE11-R, CSE11-R-DG, CSE12-L, CSE12-R, CSE12-R-DG, CSE21-L, CSE21-R, CSE21-R-DG, CSE22-L, CSE22-R, CSE22-R-DG, CSE61-L, CSE61-R, CSE61-R-DG, CSE62-L, CSE62-R, CSE62-R-DG, CSG11-L, CSG11-R, CSG11-R-DG, CSG12-L, CSG12-R, CSG12-R-DG...(Other models you can see in the webshop)		

special gaskets

for combi-steamers



1


Part No.	699480	Ref. No.	10010162
description	gasket suitable for MKN combi-steamer ED ø 74mm ID ø 60mm graphite thickness 1.5mm		
For models:	CGE11-L, CGE11-R, CGE12-L, CGE12-R, CGE21-L, CGE21-R, CGE22-L, CGE22-R, CGE61-L, CGE61-R, CGE62-L, CGE62-R, CGG11-L, CGG11-R, CGG12-L, CGG12-R, CGG21-L, CGG21-R, CGG22-L, CGG22-R, CGG61-L, CGG61-R, CGG62-L, CGG62-R, CSE11-L, CSE11-R, CSE11-R-DG, CSE12-L, CSE12-R, CSE12-R-DG, CSE21-L, CSE21-R, CSE21-R-DG, CSE22-L, CSE22-R, CSE22-R-DG, CSE61-L, CSE61-R, CSE61-R-DG, CSE62-L, CSE62-R, CSE62-R-DG, CSG11-L, CSG11-R, CSG11-R-DG, CSG12-L, CSG12-R, CSG12-R-DG, CSG21-L, CSG21-R...(Other models you can see in the webshop)		





1


Part No.	699465	Ref. No.	211129
description	gasket suitable for MKN combi-steamer L 148mm W 121mm mounting pos. - thickness 3mm		
For models:	CGE11-L, CGE11-R, CGE12-L, CGE12-R, CGE61-L, CGE61-R, CGE62-L, CGE62-R, CGG11-L, CGG11-R, CGG12-L, CGG12-R, CGG21-L, CGG21-R, CGG22-L, CGG22-R, CGG61-L, CGG61-R, CGG62-L, CGG62-R, CSE11-L, CSE11-R, CSE11-R-DG, CSE12-L, CSE12-R, CSE12-R-DG, CSE61-L, CSE61-R, CSE61-R-DG, CSE62-L, CSE62-R, CSE62-R-DG, CSG11-L, CSG11-R, CSG11-R-DG, CSG12-L, CSG12-R, CSG12-R-DG, CSG61-L, CSG61-R, CSG61-R-DG, CSG62-L, CSG62-R, CSG62-R-DG		






			
<b>Part No.</b>	699464	<b>Ref. No.</b>	211145
<b>description</b>	gasket suitable for MKN combi-steamer L 43mm W 19mm mounting pos. level glass graphite thickness 1.5mm		
<b>For models:</b>	CGG11-L, CGG11-R, CGG12-L, CGG12-R, CGG21-L, CGG21-R, CGG22-L, CGG22-R, CGG61-L, CGG61-R, CGG62-L, CGG62-R, CSG11-L, CSG11-R, CSG11-R-DG, CSG12-L, CSG12-R, CSG12-R-DG, CSG21-L, CSG21-R, CSG21-R-DG, CSG22-L, CSG22-R, CSG22-R-DG, CSG61-L, CSG61-R, CSG61-R-DG, CSG62-L, CSG62-R, CSG62-R-DG		


			
<b>Part No.</b>	699481	<b>Ref. No.</b>	10011098
<b>description</b>	gasket suitable for MKN combi-steamer L 58mm W 22mm ID ø 13mm graphite thickness 1.5mm		
<b>For models:</b>	CGE11-L, CGE11-R, CGE12-L, CGE12-R, CGE21-L, CGE21-R, CGE22-L, CGE22-R, CGE61-L, CGE61-R, CGE62-L, CGE62-R, CGG11-L, CGG11-R, CGG12-L, CGG12-R, CGG21-L, CGG21-R, CGG22-L, CGG22-R, CGG61-L, CGG61-R, CGG62-L, CGG62-R, CSE11-L, CSE11-R, CSE11-R-DG, CSE12-L, CSE12-R, CSE12-R-DG, CSE61-L, CSE61-R, CSE61-R-DG, CSE62-L, CSE62-R, CSE62-R-DG, CSG11-L, CSG11-R, CSG11-R-DG, CSG12-L, CSG12-R, CSG12-R-DG, CSG21-L, CSG21-R, CSG21-R-DG, CSG22-L, CSG22-R, CSG22-R-DG, CSG61-L, CSG61-R...(Other models you can see in the webshop)		


			
<b>Part No.</b>	699462	<b>Ref. No.</b>	211144
<b>description</b>	gasket suitable for MKN combi-steamer L 64mm W 64mm mounting pos. heat exchanger ID ø 43mm graphite thickness 1.5mm		
<b>For models:</b>	CGG11-L, CGG11-R, CGG12-L, CGG12-R, CGG21-L, CGG21-R, CGG22-L, CGG22-R, CGG61-L, CGG61-R, CGG62-L, CGG62-R, CSG11-L, CSG11-R, CSG11-R-DG, CSG12-L, CSG12-R, CSG12-R-DG, CSG21-L, CSG21-R, CSG21-R-DG, CSG22-L, CSG22-R, CSG22-R-DG, CSG61-L, CSG61-R, CSG61-R-DG, CSG62-L, CSG62-R, CSG62-R-DG		

			
<b>Part No.</b>	699463	<b>Ref. No.</b>	211097
<b>description</b>	gasket suitable for MKN combi-steamer L 70mm W 35mm mounting pos. for injection pipe ID ø 13mm graphite thickness 1mm		
<b>For models:</b>	CGE11-L, CGE11-R, CGE12-L, CGE12-R, CGE21-L, CGE21-R, CGE22-L, CGE22-R, CGE61-L, CGE61-R, CGE62-L, CGE62-R, CGG11-L, CGG11-R, CGG12-L, CGG12-R, CGG21-L, CGG21-R, CGG22-L, CGG22-R, CGG61-L, CGG61-R, CGG62-L, CGG62-R, CPE63, CSE11-L, CSE11-R, CSE11-R-DG, CSE12-L, CSE12-R, CSE12-R-DG, CSE21-L, CSE21-R, CSE21-R-DG, CSE22-L, CSE22-R, CSE22-R-DG, CSE61-L, CSE61-R, CSE61-R-DG, CSE62-L, CSE62-R, CSE62-R-DG, CSG11-L, CSG11-R, CSG11-R-DG, CSG12-L, CSG12-R, CSG12-R-DG, CSG21-L, CSG21-R, CSG21-R-DG, CSG22-L...(Other models you can see in the webshop)		

			
<b>Part No.</b>	692800	<b>Ref. No.</b>	211141
<b>description</b>	gasket suitable for MKN combi-steamer L 82mm W 62mm mounting pos. burner thickness 1.5mm graphite Qty 1 pcs		
<b>For models:</b>	CGG11-L, CGG11-R, CGG12-L, CGG12-R, CGG21-L, CGG21-R, CGG22-L, CGG22-R, CGG61-L, CGG61-R, CGG62-L, CGG62-R, CSG11-L, CSG11-R, CSG11-R-DG, CSG12-L, CSG12-R, CSG12-R-DG, CSG21-L, CSG21-R, CSG21-R-DG, CSG22-L, CSG22-R, CSG22-R-DG, CSG61-L, CSG61-R, CSG61-R-DG, CSG62-L, CSG62-R, CSG62-R-DG		

			
<b>Part No.</b>	699482	<b>Ref. No.</b>	211146
<b>description</b>	gasket suitable for MKN combi-steamer mounting pos. for lens ED ø 105mm ID ø 71mm graphite thickness 1mm		
<b>For models:</b>	CGE21-L, CGE21-R, CGE22-L, CGE22-R, CGG21-L, CGG21-R, CGG22-L, CGG22-R, CSE11-L, CSE11-R, CSE11-R-DG, CSE12-L, CSE12-R, CSE12-R-DG, CSE21-L, CSE21-R, CSE21-R-DG, CSE22-L, CSE22-R, CSE22-R-DG, CSE61-L, CSE61-R, CSE61-R-DG, CSE62-L, CSE62-R, CSE62-R-DG, CSG11-L, CSG11-R, CSG11-R-DG, CSG12-L, CSG12-R, CSG12-R-DG, CSG21-L, CSG21-R, CSG21-R-DG, CSG22-L, CSG22-R, CSG22-R-DG, CSG61-L, CSG61-R, CSG61-R-DG, CSG62-L, CSG62-R, CSG62-R-DG		
<b>accessories for</b>	699482		
		<b>Part No.</b>	694294
		<b>Ref. No.</b>	216115
	glass panel ø 90mm thickness 8mm		

			
<b>Part No.</b>	699483	<b>Ref. No.</b>	214009
<b>description</b>	gasket suitable for MKN combi-steamer mounting pos. for temperature probe ED ø 19mm ID ø 12mm graphite thickness 1mm		
<b>For models:</b>	CCE60, CCE63, CGE11-L, CGE11-R, CGE12-L, CGE12-R, CGE21-L, CGE21-R, CGE22-L, CGE22-R, CGE61-L, CGE61-R, CGE62-L, CGE62-R, CGG11-L, CGG11-R, CGG12-L, CGG12-R, CGG21-L, CGG21-R, CGG22-L, CGG22-R, CGG61-L, CGG61-R, CGG62-L, CGG62-R, CPE60, CPE63, CSE11-L, CSE11-R, CSE11-R-DG, CSE12-L, CSE12-R, CSE12-R-DG, CSE61-L, CSE61-R, CSE61-R-DG, CSE62-L, CSE62-R, CSE62-R-DG, CSG11-L, CSG11-R, CSG11-R-DG, CSG12-L, CSG12-R, CSG12-R-DG, CSG21-L, CSG21-R, CSG21-R-DG, CSG22-L...(Other models you can see in the webshop)		

			
<b>Part No.</b>	699479	<b>Ref. No.</b>	10010164
<b>description</b>	gasket suitable for MKN combi-steamer mounting pos. outflow ED ø 115mm ID ø 71mm graphite thickness 1.5mm		
<b>For models:</b>	CGE21-L, CGE21-R, CGE22-L, CGE22-R, CGG21-L, CGG21-R, CGG22-L, CGG22-R, CSG21-L, CSG21-R, CSG21-R-DG, CSG22-L, CSG22-R, CSG22-R-DG		



1

<b>Part No.</b>	699478	<b>Ref. No.</b>	10010161
<b>description</b>	gasket suitable for MKN combi-steamer mounting pos. outflow ED ø 88mm ID ø 53mm graphite thickness 1.5mm		
<b>For models:</b>	CGE11-L, CGE11-R, CGE12-L, CGE12-R, CGE61-L, CGE61-R, CGE62-L, CGE62-R, CGG11-L, CGG11-R, CGG12-L, CGG12-R, CGG61-L, CGG61-R, CGG62-L, CGG62-R, CSE11-L, CSE11-R, CSE11-R-DG, CSE12-L, CSE12-R, CSE12-R-DG, CSE61-L, CSE61-R, CSE61-R-DG, CSE62-L, CSE62-R, CSE62-R-DG, CSG11-L, CSG11-R, CSG11-R-DG, CSG12-L, CSG12-R, CSG12-R-DG, CSG61-L, CSG61-R, CSG61-R-DG, CSG62-L, CSG62-R, CSG62-R-DG		

1

<b>Part No.</b>	699461	<b>Ref. No.</b>	211142
<b>description</b>	gasket suitable for MKN combi-steamer mounting pos. radial fan ED ø 82mm ID ø 52mm graphite thickness 1.5mm		
<b>For models:</b>	1462831-00, 1462832-00, 1462833-00, 1462834-00, 1462835-00, 1462836-00, 1462837-00, 1462838-00, 1462839-00, 1462840-00, 1462908-00, 1462910-00, 2062831-00, 2062832-00, 2062833-00, 2062834-00, 2062835-00, 2062835-01, 2062836-00, 2062836-01, 2062837-00, 2062837-01, 2062838-00, 2062838-01, 2062839-00, 2062839-01, 2062840-00, 2062840-01, 2062908-00, 2062910-00, 2162835-00, 2162835-01, 2162838-00, 2162838-01, 3062831-00, 3062832-00, 3062833-00, 3062834-00, 3062835-00, 3062836-00, 3062837-00, 3062838-00, 3062839-00, 3062840-00, 3062908-00, 3062910-00, CGG11-L, CGG11-R, CGG12-L, CGG12-R...(Other models you can see in the webshop)		

1

<b>Part No.</b>	699466	<b>Ref. No.</b>	211123
<b>description</b>	gasket suitable for MKN ED ø 9mm ID ø 5mm thickness 3.7mm		
<b>For models:</b>	CGE11-L, CGE11-R, CGE12-L, CGE12-R, CGE61-L, CGE61-R, CGE62-L, CGE62-R, CGG11-L, CGG11-R, CGG12-L, CGG12-R, CGG61-L, CGG61-R, CGG62-L, CGG62-R, CSE11-L, CSE11-R, CSE11-R-DG, CSE12-L, CSE12-R, CSE12-R-DG, CSE61-L, CSE61-R, CSE61-R-DG, CSE62-L, CSE62-R, CSE62-R-DG, CSG11-L, CSG11-R, CSG11-R-DG, CSG12-L, CSG12-R, CSG12-R-DG, CSG61-L, CSG61-R, CSG61-R-DG, CSG62-L, CSG62-R, CSG62-R-DG		

1

<b>Part No.</b>	699458	<b>Ref. No.</b>	211099
<b>description</b>	gasket suitable for MKN for pipe DN70 ring - combi-steamer		
<b>For models:</b>	CGE21-L, CGE21-R, CGE22-L, CGE22-R, CGG21-L, CGG21-R, CGG22-L, CGG22-R, CSE21-L, CSE21-R, CSE21-R-DG, CSE22-L, CSE22-R, CSE22-R-DG, CSG21-L, CSG21-R, CSG21-R-DG, CSG22-L, CSG22-R, CSG22-R-DG		

1

<b>Part No.</b>	699460	<b>Ref. No.</b>	211092
<b>description</b>	gasket suitable for MKN for spray gun grommet ED ø 56mm ID ø 32.5mm foam seal thickness 13mm combi-steamer		
<b>For models:</b>	CGE11-L, CGE11-R, CGE12-L, CGE12-R, CGE21-L, CGE21-R, CGE22-L, CGE22-R, CGE61-L, CGE61-R, CGE62-L, CGE62-R, CGG11-L, CGG11-R, CGG12-L, CGG12-R, CGG21-L, CGG21-R, CGG22-L, CGG22-R, CGG61-L, CGG61-R, CGG62-L, CGG62-R, CSE11-L, CSE11-R, CSE11-R-DG, CSE12-L, CSE12-R, CSE12-R-DG, CSE21-L, CSE21-R, CSE22-L, CSE22-R, CSE61-L, CSE61-R, CSE61-R-DG, CSE62-L, CSE62-R, CSE62-R-DG, CSG11-L, CSG11-R, CSG11-R-DG, CSG12-L, CSG12-R, CSG12-R-DG, CSG21-L, CSG21-R, CSG22-L, CSG22-R...(Other models you can see in the webshop)		

1

<b>Part No.</b>	699362	<b>Ref. No.</b>	211079
<b>description</b>	gasket suitable for MKN profile no to be sold in France for combi-steamer ED ø 58mm rubber DN 50mm		
<b>For models:</b>	815156, 815157, 815166, 815167, 845906, 845986, 846111, 846116, CGE11-L, CGE11-R, CGE12-L, CGE12-R, CGE61-L, CGE61-R, CGE62-L, CGE62-R, CGG11-L, CGG11-R, CGG12-L, CGG12-R, CGG21-L, CGG21-R, CGG22-L, CGG22-R, CGG61-L, CGG61-R, CGG62-L, CGG62-R, CSE11-L, CSE11-R, CSE11-R-DG, CSE12-L, CSE12-R, CSE12-R-DG, CSE61-L, CSE61-R, CSE61-R-DG, CSE62-L, CSE62-R, CSE62-R-DG, CSG11-L, CSG11-R, CSG11-R-DG, CSG12-L, CSG12-R, CSG12-R-DG, CSG21-L, CSG21-R, CSG21-R-DG, CSG22-L...(Other models you can see in the webshop)		


1


<b>Part No.</b>	699459	<b>Ref. No.</b>	211131
<b>description</b>	gasket suitable for MKN size 24x34x10 ring - combi-steamer		
<b>For models:</b>	CCE60, CCE63, CGE11-L, CGE11-R, CGE12-L, CGE12-R, CGE21-L, CGE21-R, CGE22-L, CGE22-R, CGE61-L, CGE61-R, CGE62-L, CGE62-R, CGG11-L, CGG11-R, CGG12-L, CGG12-R, CGG21-L, CGG21-R, CGG22-L, CGG22-R, CGG61-L, CGG61-R, CGG62-L, CGG62-R, CPE60, CPE63, CSE11-L, CSE11-R, CSE11-R-DG, CSE12-L, CSE12-R, CSE12-R-DG, CSE21-L, CSE21-R, CSE21-R-DG, CSE22-L, CSE22-R, CSE22-R-DG, CSE61-L, CSE61-R, CSE61-R-DG, CSE62-L, CSE62-R, CSE62-R-DG, CSG11-L, CSG11-R, CSG11-R-DG, CSG12-L...(Other models you can see in the webshop)		





			
1			
<b>Part No.</b>	699366	<b>Ref. No.</b>	211080
<b>description</b>	gasket suitable for profile for combi-steamer ED ø 42mm ID ø 36mm rubber thickness 6.5mm		
<b>For models:</b>	CCE60, CCE63, CGE11-L, CGE11-R, CGE12-L, CGE12-R, CGE21-L, CGE21-R, CGE22-L, CGE22-R, CGE61-L, CGE61-R, CGE62-L, CGE62-R, CGG11-L, CGG11-R, CGG12-L, CGG12-R, CGG21-L, CGG21-R, CGG22-L, CGG22-R, CGG61-L, CGG61-R, CGG62-L, CGG62-R, CPE60, CPE63, CSE11-L, CSE11-R, CSE11-R-DG, CSE12-L, CSE12-R, CSE12-R-DG, CSE21-L, CSE21-R, CSE21-R-DG, CSE22-L, CSE22-R, CSE22-R-DG, CSE61-L, CSE61-R, CSE61-R-DG, CSE62-L, CSE62-R, CSE62-R-DG, CSG11-L, CSG11-R, CSG11-R-DG, CSG12-L...(Other models you can see in the webshop)		


			
1			
<b>Part No.</b>	699365	<b>Ref. No.</b>	211078
<b>description</b>	gasket U-bend L 73mm W 73mm ID ø 60mm thickness 3mm		
<b>For models:</b>	CGE11-L, CGE11-R, CGE12-L, CGE12-R, CGE21-L, CGE21-R, CGE22-L, CGE22-R, CGE61-L, CGE61-R, CGE62-L, CGE62-R, CGG11-L, CGG11-R, CGG12-L, CGG12-R, CGG21-L, CGG21-R, CGG22-L, CGG22-R, CGG61-L, CGG61-R, CGG62-L, CGG62-R, CSE11-L, CSE11-R, CSE11-R-DG, CSE12-L, CSE12-R, CSE12-R-DG, CSE21-L, CSE21-R, CSE21-R-DG, CSE22-L, CSE22-R, CSE22-R-DG, CSE61-L, CSE61-R, CSE61-R-DG, CSE62-L, CSE62-R, CSE62-R-DG, CSG11-L, CSG11-R, CSG11-R-DG, CSG12-L, CSG12-R, CSG12-R-DG, CSG21-L, CSG21-R...(Other models you can see in the webshop)		

<b>miscellaneous</b>			
			
1			
<b>Part No.</b>	550289	<b>Ref. No.</b>	211003
<b>description</b>	flat gasket		
<b>For models:</b>	0524301-01, 0524302-01, 0524303-01, 0524304-01, 0720325-03, 0720325-04, 0720325B03, 0720325B04, 0720332P00, 0720332R00, 0720332T00, 0720332V00, 0720504-04, 0721134-01, 0721134A01, 0721172A01, 0721173A01, 0721174A01, 0721175A01, 0722101-06, 0723104-03, 0723104A03, 0723104B03, 0723105-03, 0723105A03, 0723105B03, 0723405-01, 0723405-02, 0723409-01, 0723409-02, 0723412K01, 0723413-02, 0723414-02, 1020510-00, 1022603-00, 1023101-00, 1023101-01, 1023106-00, 1023106-01, 1023111-00, 1023111-01, 1023401-00, 1023401K00, 1023410-00, 1121121-00, 1121121A00, 1220301-00, 1220301-01, 1220301-02, 1220301-03...(Other models you can see in the webshop)		

## evaporators


## for fridges


## producer-specific

			
1			
<b>Part No.</b>	750238	<b>Ref. No.</b>	935611
<b>description</b>	evaporator L 535mm W 80mm H 205mm		


## springs

## torsion springs

			
1			
<b>Part No.</b>	699291	<b>Ref. No.</b>	216156
<b>description</b>	torsion spring ø 24mm L2 69mm wire gauge ø 3mm L1 23mm L3 69mm for door handle		
<b>For models:</b>	CCE60, CCE63, CPE60, CPE63		


			
1			
<b>Part No.</b>	700514	<b>Ref. No.</b>	216079
<b>description</b>	torsion spring ø 26.6mm wire gauge ø 6.1mm L1 420mm L3 26mm		
<b>For models:</b>	0522101-00, 0522101-01, 0522101-02, 0522101-03, 0522101-04, 0522102-00, 0522102-01, 0522102-02, 0522102-03, 0522102-04, 0722101-06, 1323208-00, 1323208-01, 1323208-02, 1323208-03, 1323208-04, 1323210-00, 1323210-01, 1323210-02, 1323210-03, 1323210-04, 1323403-00, 1323403K00, 1323506-00, 1323506-01, 1323506A00, 1323506A01, 1323517-00, 1323517A00, 1363403-00, 1363403-01, 1363403-02, 1363403-03, 1363403-04, 1363403-05, 1363415-05, 1422101-00, 1422101-01, 1422101-02, 1422101-03, 1422101-04, 1422101-05, 1422101-06, 1422102-00, 1422102-01, 1422102-02, 1422102-03, 1422102-04, 1422102-05, 1422104-05...(Other models you can see in the webshop)		



## tension springs


			
1			
<b>Part No.</b>	700552	<b>Ref. No.</b>	216084
<b>description</b>	tension spring		
<b>For models:</b>	2013003B01, 2013003B02, 2013003B03, 2013003B04, 2013003B05, 2013003B06, 2013007B01, 2013007B02, 2013007B03, 2013007B04, 2013007B05, 2013007B06, 2013009B01, 2013009B02, 2013009B03, 2013009B04, 2013009B05, 2013009B06, 2013017B00, 2013017B01, 2013017B02, 2013017B03, 2013017B04, 2013017B05, 2021403-00, 2021403-01, 2021403-02, 2021403-03, 2021403-04, 2021403-05, 2021403-06, 20214033-0, 2021403A00, 2021403A01, 2021403A02, 2021403A04, 2021403A05, 2021403A06, 2021403B00, 2021403B01, 2021403B02, 2021403B04, 2021403B05, 2021403B06, 2021403C01, 2021403C02, 2021403C04, 2021403C05, 2021403C06, 2021405-00...(Other models you can see in the webshop)		



manometers


 <p>1</p>			
<b>Part No.</b>	541427	<b>Ref. No.</b>	201106
<b>description</b>	manometer ø 62mm pressure range 0 up to 1.6bar thread 1/4" marking 0.5 connection on the backside		
<b>For models:</b>	14228011-0, 14228022-0, 14228033-0, 14228044-0, 14228055-0, 2012801-00, 2012801-01, 2012801A00, 2012801A01, 2012801B00, 2012801B01, 2012801C00, 2012801C01, 2012802-00, 2012802-01, 2012802A00, 2012802A01, 2012802B00, 2012802B01, 2012802C00, 2012802C01, 2012803-00, 2012803-01, 2012803A00, 2012803A01, 2012803B00, 2012803B01, 2012803C00, 2012803C01, 2012804-00, 2012804-01, 2012804A00, 2012804A01, 2012804B00, 2012804B01, 2012804C00, 2012804C01, 2012805-00, 2012805-01, 2012805A00, 2012805A01, 2012805B00, 2012805B01, 2012805C00, 2012805C01, 2012806B00, 2012806C00, 2012807B00, 2012807C00, 2012901B00... (Other models you can see in the webshop)		


 <p>1</p>							
<b>Part No.</b>	541062	<b>Ref. No.</b>	201105				
<b>description</b>	manometer ø 63mm pressure range 0 up to 1bar connection marking adjustable kettle thread 1/4"						
<b>spare parts for</b>	541062						
	<table border="1"> <tr> <td><b>Part No.</b></td> <td>541130</td> <td><b>Ref. No.</b></td> <td>—</td> </tr> </table>	<b>Part No.</b>	541130	<b>Ref. No.</b>	—		
<b>Part No.</b>	541130	<b>Ref. No.</b>	—				
	 <p>glass panel ø 58mm thickness 2mm</p>						


 <p>1</p>			
<b>Part No.</b>	541099	<b>Ref. No.</b>	201731
<b>description</b>	manometer ø 63mm pressure range -1.5 up to +1.5bar thread 1/4" marking 1 kettle		
<b>For models:</b>	1412831-00, 1412832-00, 1412833-00, 1412833-01, 1412834-00, 1412834-01, 1412908-00, 1412910-00, 1412910-01, 1422802B04, 1422802B05, 1422802B06, 1422802B07, 1422802B08, 1422804B04, 1422804B05, 1422804B06, 1422804B07, 1422804B08, 1422805B04, 1422805B05, 1422805B06, 1422805B07, 1422805B08, 1422807B00, 1422807B01, 1422807B02, 1422807B03, 1422807B04, 1422831-00, 1422832-00, 1422833-00, 1422834-00, 1422902-00, 1422902-01, 1422902-02, 1422902-03, 1422902-04, 1422908-00, 1422910-00, 1462802B00, 1462802B01, 1462802B02, 1462802B03, 1462802B04, 1462802B05, 1462804B00, 1462804B01, 1462804B02, 1462804B03... (Other models you can see in the webshop)		

hose reels and spray guns

spray guns

 <p>1</p>			
<b>Part No.</b>	542800	<b>Ref. No.</b>	201147
<b>description</b>	spray gun for appliances 1/2" ET L 120mm with backflow preventer type MKN		
<b>For models:</b>	CGE11-L, CGE11-R, CGE12-L, CGE12-R, CGE21-L, CGE21-R, CGE22-L, CGE22-R, CGE61-L, CGE61-R, CGE62-L, CGE62-R, CGG11-L, CGG11-R, CGG12-L, CGG12-R, CGG21-L, CGG21-R, CGG22-L, CGG22-R, CGG61-L, CGG61-R, CGG62-L, CGG62-R, CSE11-L, CSE11-R, CSE11-R-DG, CSE12-L, CSE12-R, CSE12-R-DG, CSE21-L, CSE21-R, CSE21-R-DG, CSE22-L, CSE22-R, CSE22-R-DG, CSE61-L, CSE61-R, CSE61-R-DG, CSE62-L, CSE62-R, CSE62-R-DG, CSG11-L, CSG11-R, CSG11-R-DG, CSG12-L, CSG12-R, CSG12-R-DG, CSG21-L, CSG21-R... (Other models you can see in the webshop)		

 <p>1</p>			
<b>Part No.</b>	699460	<b>Ref. No.</b>	211092
<b>description</b>	gasket suitable for MKN for spray gun grommet ED ø 56mm ID ø 32.5mm foam seal thickness 13mm combi-steamer		
<b>For models:</b>	CGE11-L, CGE11-R, CGE12-L, CGE12-R, CGE21-L, CGE21-R, CGE22-L, CGE22-R, CGE61-L, CGE61-R, CGE62-L, CGE62-R, CGG11-L, CGG11-R, CGG12-L, CGG12-R, CGG21-L, CGG21-R, CGG22-L, CGG22-R, CGG61-L, CGG61-R, CGG62-L, CGG62-R, CSE11-L, CSE11-R, CSE11-R-DG, CSE12-L, CSE12-R, CSE12-R-DG, CSE21-L, CSE21-R, CSE22-L, CSE22-R, CSE61-L, CSE61-R, CSE61-R-DG, CSE62-L, CSE62-R, CSE62-R-DG, CSG11-L, CSG11-R, CSG11-R-DG, CSG12-L, CSG12-R, CSG12-R-DG, CSG21-L, CSG21-R, CSG22-R... (Other models you can see in the webshop)		

 <p>1</p>			
<b>Part No.</b>	694988	<b>Ref. No.</b>	204428
<b>description</b>	grommet connection bush Hans Dampf for spray gun		
<b>For models:</b>	CGE11-L, CGE11-R, CGE12-L, CGE12-R, CGE21-L, CGE21-R, CGE22-L, CGE22-R, CGE61-L, CGE61-R, CGE62-L, CGE62-R, CGG11-L, CGG11-R, CGG12-L, CGG12-R, CGG21-L, CGG21-R, CGG22-L, CGG22-R, CGG61-L, CGG61-R, CGG62-L, CGG62-R, CSE11-L, CSE11-R, CSE11-R-DG, CSE12-L, CSE12-R, CSE12-R-DG, CSE21-L, CSE21-R, CSE21-R-DG, CSE22-L, CSE22-R, CSE22-R-DG, CSE61-L, CSE61-R, CSE61-R-DG, CSE62-L, CSE62-R, CSE62-R-DG, CSG11-L, CSG11-R, CSG11-R-DG, CSG12-L, CSG12-R, CSG12-R-DG, CSG21-L, CSG21-R... (Other models you can see in the webshop)		

mechanical components, equipment accessories



## hose reels

## appliance hose reels



1

Part No.	542804	Ref. No.	204410
description	hose reel without spray gun hose length 1.8m		
For models:	CGE11-L, CGE11-R, CGE12-L, CGE12-R, CGE21-L, CGE21-R, CGE22-L, CGE22-R, CGE61-L, CGE61-R, CGE62-L, CGE62-R, CGG11-L, CGG11-R, CGG12-L, CGG12-R, CGG21-L, CGG21-R, CGG22-L, CGG22-R, CGG61-L, CGG61-R, CGG62-L, CGG62-R, CSE11-L, CSE11-R, CSE11-R-DG, CSE12-L, CSE12-R, CSE12-R-DG, CSE21-L, CSE21-R, CSE21-R-DG, CSE22-L, CSE22-R, CSE22-R-DG, CSE61-L, CSE61-R, CSE61-R-DG, CSE62-L, CSE62-R, CSE62-R-DG, CSG11-L, CSG11-R, CSG11-R-DG, CSG12-L, CSG12-R, CSG21-L, CSG21-R, CSG21-R-DG...(Other models you can see in the webshop)		

## dosing pumps

## membrane dosing pumps



## self-priming

## LANG

## accessories



1

Part No.	101286	Ref. No.	201571	
description	olive ID ø 6mm Qty 1 pcs			
For models:	0260301-00, 0260301-01, 0260302-00, 0260302-01, 1260301-00, 1260301-01, 1260302-00, 1260302-01, 1412831-00, 1412832-00, 1412833-00, 1412833-01, 1412834-00, 1412834-01, 1412908-00, 1412910-00, 1412910-01, 1422802B04, 1422802B05, 1422802B06, 1422802B07, 1422802B08, 1422804B04, 1422804B05, 1422804B06, 1422804B07, 1422804B08, 1422805B04, 1422805B05, 1422805B06, 1422805B07, 1422805B08, 1422807B00, 1422807B01, 1422807B02, 1422807B03, 1422807B04, 1422831-00, 1422832-00, 1422833-00, 1422834-00, 1422902-00, 1422902-01, 1422902-02, 1422902-03, 1422902-04, 1422908-00, 1422910-00, 1423901-00, 1423901-01...(Other models you can see in the webshop)			
accessories for	101286			
	Part No.	100909	Ref. No.	—
union screw thread M10x1 for pipe ø 6mm Qty 1 pcs				
	Part No.	101464	Ref. No.	—
union nut thread M12x1 for pipe ø 6mm				

## hoses

## industrial hoses

## nylon hoses



1

Part No.	530566	Ref. No.	050016
description	nylon hose ID ø 8mm ED ø 10mm L 5m thickness 1mm operating p. 10bar burst p. 50bar t.max. 100°C transparent		
For models:	CGE11-L, CGE11-R, CGE12-L, CGE12-R, CGE21-L, CGE21-R, CGE22-L, CGE22-R, CGE61-L, CGE61-R, CGE62-L, CGE62-R, CGG11-L, CGG11-R, CGG12-L, CGG12-R, CGG21-L, CGG21-R, CGG22-L, CGG22-R, CGG61-L, CGG61-R, CGG62-L, CGG62-R, CSE11-L, CSE11-R, CSE11-R-DG, CSE12-L, CSE12-R, CSE12-R-DG, CSE21-L, CSE21-R, CSE21-R-DG, CSE22-L, CSE22-R, CSE22-R-DG, CSE61-L, CSE61-R, CSE61-R-DG, CSE62-L, CSE62-R, CSE62-R-DG, CSG11-L, CSG11-R, CSG11-R-DG, CSG12-L, CSG12-R, CSG12-R-DG, CSG21-L, CSG21-R...(Other models you can see in the webshop)		

## silicone hoses

## without fabric



1

Part No.	530898	Ref. No.	050015
description	silicone hose ID ø 60mm ED ø 64mm L 1m thickness 2mm		
For models:	815156, 815157, 815166, 815167, CCE60, CCE63, CGE11-L, CGE11-R, CGE12-L, CGE12-R, CGE21-L, CGE21-R, CGE22-L, CGE22-R, CGE61-L, CGE61-R, CGE62-L, CGE62-R, CGG11-L, CGG11-R, CGG12-L, CGG12-R, CGG21-L, CGG21-R, CGG22-L, CGG22-R, CGG61-L, CGG61-R, CGG62-L, CGG62-R, CPE60, CPE63, CSE11-L, CSE11-R, CSE11-R-DG, CSE12-L, CSE12-R, CSE12-R-DG, CSE21-L, CSE21-R, CSE21-R-DG, CSE22-L, CSE22-R, CSE22-R-DG, CSE61-L, CSE61-R, CSE61-R-DG, CSE62-L, CSE62-R, CSE62-R-DG...(Other models you can see in the webshop)		

## pressure hoses (other)



1

Part No.	520107	Ref. No.	050003
description	pressure hose		
For models:	1412831-00, 1412832-00, 1412833-00, 1412833-01, 1412834-00, 1412834-01, 1412908-00, 1412910-00, 1412910-01, 14228011-0, 14228022-0, 1422802B04, 1422802B05, 1422802B06, 1422802B07, 1422802B08, 14228033-0, 14228044-0, 1422804B04, 1422804B05, 1422804B06, 1422804B07, 1422804B08, 14228055-0, 1422805B04, 1422805B05, 1422805B06, 1422805B07, 1422805B08, 1422807B00, 1422807B01, 1422807B02, 1422807B03, 1422807B04, 1422831-00, 1422832-00, 1422833-00, 1422834-00, 1422902-00, 1422902-01, 1422902-02, 1422902-03, 1422902-04, 1422908-00, 1422910-00, 1423901-00, 1423901-01, 1423901-02, 1423902-00, 1423902-01...(Other models you can see in the webshop)		



formed hoses

miscellaneous



<b>Part No.</b>	513326	<b>Ref. No.</b>	050024 204690
<b>description</b>	formed hose ID ø 15mm ED ø 24mm U-bend		
<b>For models:</b>	CGE11-L, CGE11-R, CGE12-L, CGE12-R, CGE61-L, CGE61-R, CGE62-L, CGE62-R, CGG11-L, CGG11-R, CGG12-L, CGG12-R, CGG61-L, CGG61-R, CGG62-L, CGG62-R, CSE11-L, CSE11-R, CSE11-R-DG, CSE12-L, CSE12-R, CSE12-R-DG, CSE61-L, CSE61-R, CSE61-R-DG, CSE62-L, CSE62-R, CSE62-R-DG, CSG11-L, CSG11-R, CSG11-R-DG, CSG12-L, CSG12-R, CSG12-R-DG, CSG61-L, CSG61-R, CSG61-R-DG, CSG62-L, CSG62-R, CSG62-R-DG		

miscellaneous



<b>Part No.</b>	520375	<b>Ref. No.</b>	201038
<b>description</b>	screw connection thread 1" L 42mm ø 30mm		
<b>For models:</b>	0220301D00, 0220302D00, 0220302E00, 0220302E01, 0220303D00, 0220303D01, 0220303E00, 0220303E01, 0260301-00, 0260301-01, 0260302-00, 0260302-01, 0720504-04, 1220301D00, 1220301D01, 1220301E00, 1220301E01, 1220302D00, 1220302E00, 1220303D00, 1220303D01, 1220303D02, 1220303E00, 1220303E01, 1220303E02, 1220303F01, 1220303F02, 1220303F03, 1220303H00, 1220303H01, 1220303H02, 1220303H03, 1220304D00, 1220304E00, 1220304F00, 1220304H00, 1220305D00, 1220305D01, 1220305D02, 1220305D03, 1220305D04, 1220305E00, 1220305E01, 1220305E02, 1220305E03, 1220305E04, 1220305F01, 1220305F02, 1220305F03, 1220305F04... (Other models you can see in the webshop)		

fittings, hose and pipe connectors

hose connectors

without screw connection



<b>Part No.</b>	504817	<b>Ref. No.</b>	205174
<b>description</b>	T-piece SS hose ø 10-10-10mm		
<b>For models:</b>	CCE60, CCE63, CGE21-L, CGE21-R, CGE22-L, CGE22-R, CGG21-L, CGG21-R, CGG22-L, CGG22-R, CPE60, CPE63, CSE21-L, CSE21-R, CSE21-R-DG, CSE22-L, CSE22-R, CSE22-R-DG, CSG21-L, CSG21-R, CSG21-R-DG, CSG22-L, CSG22-R, CSG22-R-DG		

hose connectors

plastic



<b>Part No.</b>	506275	<b>Ref. No.</b>	205320
<b>description</b>	hose connector plastic straight thread G 3/4" hose ø 11mm Qty 1 pcs with gasket		
<b>For models:</b>	CCE60, CCE63, CGE11-L, CGE11-R, CGE12-L, CGE12-R, CGE21-L, CGE21-R, CGE22-L, CGE22-R, CGE61-L, CGE61-R, CGE62-L, CGE62-R, CGG11-L, CGG11-R, CGG12-L, CGG12-R, CGG21-L, CGG21-R, CGG22-L, CGG22-R, CGG61-L, CGG61-R, CGG62-L, CGG62-R, CPE60, CPE63, CSE11-L, CSE11-R, CSE11-R-DG, CSE12-L, CSE12-R, CSE12-R-DG, CSE21-L, CSE21-R, CSE21-R-DG, CSE22-L, CSE22-R, CSE22-R-DG, CSE61-L, CSE61-R, CSE61-R-DG, CSE62-L, CSE62-R, CSE62-R-DG, CSG11-L, CSG11-R, CSG11-R-DG, CSG12-L... (Other models you can see in the webshop)		

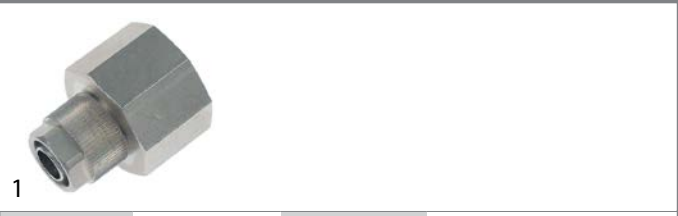
fittings

sleeves




<b>Part No.</b>	521282	<b>Ref. No.</b>	205296
<b>description</b>	sleeve thread 1/4" - 1/4" SS WS 17 total length 22mm		
<b>For models:</b>	CGE11-L, CGE11-R, CGE12-L, CGE12-R, CGE21-L, CGE21-R, CGE22-L, CGE22-R, CGE61-L, CGE61-R, CGE62-L, CGE62-R, CGG11-L, CGG11-R, CGG12-L, CGG12-R, CGG21-L, CGG21-R, CGG22-L, CGG22-R, CGG61-L, CGG61-R, CGG62-L, CGG62-R, CSE11-L, CSE11-R, CSE11-R-DG, CSE12-L, CSE12-R, CSE12-R-DG, CSE21-L, CSE21-R, CSE21-R-DG, CSE22-L, CSE22-R, CSE22-R-DG, CSE61-L, CSE61-R, CSE61-R-DG, CSE62-L, CSE62-R, CSE62-R-DG, CSG11-L, CSG11-R, CSG11-R-DG, CSG12-L, CSG12-R, CSG12-L, CSG21-R, CSG21-R-DG... (Other models you can see in the webshop)		


nickel-plated brass



<b>Part No.</b>	362019	<b>Ref. No.</b>	205298
<b>description</b>	screw pipe fitting straight nickel-plated brass thread 1/2" hose ø 8/10mm Qty 1 pcs		
<b>For models:</b>	CGE11-L, CGE11-R, CGE12-L, CGE12-R, CGE21-L, CGE21-R, CGE22-L, CGE22-R, CGE61-L, CGE61-R, CGE62-L, CGE62-R, CGG11-L, CGG11-R, CGG12-L, CGG12-R, CGG21-L, CGG21-R, CGG22-L, CGG22-R, CGG61-L, CGG61-R, CGG62-L, CGG62-R, CSE11-L, CSE11-R, CSE11-R-DG, CSE12-L, CSE12-R, CSE12-R-DG, CSE21-L, CSE21-R, CSE21-R-DG, CSE22-L, CSE22-R, CSE22-R-DG, CSE61-L, CSE61-R, CSE61-R-DG, CSE62-L, CSE62-R, CSE62-R-DG, CSG11-L, CSG11-R, CSG11-R-DG, CSG12-L, CSG12-R, CSG12-R-DG, CSG21-L, CSG21-R... (Other models you can see in the webshop)		



			
<b>Part No.</b>	362018	<b>Ref. No.</b>	205297
<b>description</b>	screw pipe fitting angled 90° nickel-plated brass thread 1/4" hose ø 8/10mm Qty 1 pcs		
<b>For models:</b>	CGE11-L, CGE11-R, CGE12-L, CGE12-R, CGE21-L, CGE21-R, CGE22-L, CGE22-R, CGE61-L, CGE61-R, CGE62-L, CGE62-R, CGG11-L, CGG11-R, CGG12-L, CGG12-R, CGG21-L, CGG21-R, CGG22-L, CGG22-R, CGG61-L, CGG61-R, CGG62-L, CGG62-R, CSE11-L, CSE11-R, CSE11-R-DG, CSE12-L, CSE12-R, CSE12-R-DG, CSE21-L, CSE21-R, CSE21-R-DG, CSE22-L, CSE22-R, CSE22-R-DG, CSE61-L, CSE61-R, CSE61-R-DG, CSE62-L, CSE62-R, CSE62-R-DG, CSG11-L, CSG11-R, CSG11-R-DG, CSG12-L, CSG12-R, CSG12-R-DG, CSG21-L, CSG21-R...(Other models you can see in the webshop)		


<b>producer-specific</b>			
<b>MKN</b>			
			
<b>Part No.</b>	541457	<b>Ref. No.</b>	201012
<b>description</b>	ball valve connection 1/2" ET		
<b>For models:</b>	14228011-0, 14228022-0, 1422802B04, 1422802B05, 1422802B06, 1422802B07, 1422802B08, 14228033-0, 14228044-0, 1422804B04, 1422804B05, 1422804B06, 1422804B07, 1422804B08, 14228055-0, 1422805B04, 1422805B05, 1422805B06, 1422805B07, 1422805B08, 1422807B00, 1422807B01, 1422807B02, 1422807B03, 1422807B04, 1422831-00, 1422832-00, 1422833-00, 1422834-00, 1422902-00, 1422902-01, 1422902-02, 1422902-03, 1422902-04, 1422908-00, 1422910-00, 1423901-00, 1423901-01, 1423901-02, 1423902-00, 1423902-01, 1423902-02, 1423903-00, 1423903-01, 1423903-02, 1462802B00, 1462802B01, 1462802B02, 1462802B03, 1462802B04...(Other models you can see in the webshop)		

## valves and tank inlets

### ball valves

#### universal


#### ball valves with butterfly handle

			
<b>Part No.</b>	542430	<b>Ref. No.</b>	201171
<b>description</b>	ball valve connection 3/4" IT - 3/4" IT DN20 PN 64 total length 78mm stainless steel		
<b>For models:</b>	0720325-03, 0720325-04, 0720325B03, 0720325B04, 0720332P00, 0720332R00, 0720332T00, 0720332V00, 1220321-00, 1220321-01, 1220321B00, 1220321B01, 1220325-00, 1220325-01, 1220325-02, 1220325B00, 1220325B01, 1220325B02, 1220327-00, 1220327-01, 1220327B01, 1220329-00, 1220329-01, 1220329B00, 1220329B01, 1220330-00, 1220330-01, 1220330B00, 1220330B01, 1320321-00, 1320321-01, 1320321-02, 1320321B00, 1320321B01, 1320321B02, 1320323-00, 1320323B00, 1320325-00, 1320325-01, 1320325-02, 1320325A00, 1320325A01, 1320325A02, 1320325B00, 1320325B01, 1320325B02, 1320325C00, 1320325C01, 1320325C02, 1320327-00...(Other models you can see in the webshop)		

### gate valves

			
<b>Part No.</b>	520377	<b>Ref. No.</b>	201033 201071
<b>description</b>	gate valve connection 1" IT - 1" IT total length 51mm chrome-plated brass		
<b>For models:</b>	0220301D00, 0220302D00, 0220302E00, 0220302E01, 0220303D00, 0220303D01, 0220303E00, 0220303E01, 0260301-00, 0260301-01, 0260302-00, 0260302-01, 0720504-04, 1220301D00, 1220301D01, 1220301E00, 1220301E01, 1220302D00, 1220302E00, 1220303D00, 1220303D01, 1220303D02, 1220303E00, 1220303E01, 1220303E02, 1220303F01, 1220303F02, 1220303F03, 1220303H00, 1220303H01, 1220303H02, 1220303H03, 1220304D00, 1220304E00, 1220304F00, 1220304H00, 1220305D00, 1220305D01, 1220305D02, 1220305D03, 1220305D04, 1220305E00, 1220305E01, 1220305E02, 1220305E03, 1220305E04, 1220305F01, 1220305F02, 1220305F03, 1220305F04...(Other models you can see in the webshop)		

#### ball valves with lever handle

			
<b>Part No.</b>	514442	<b>Ref. No.</b>	201762
<b>description</b>	ball valve connection 1 1/2" IT - 1 1/2" IT total length 93mm with lever handle handle length 155mm		
<b>For models:</b>	1220402-00, 1220402-01, 1220504-01, 1222601-00, 1222603-00, 1320402-00, 1320402-01, 1320504-01, 1320504-02, 1322601-00, 1322603-00, 1322604-00, 1420402-00, 1420402-01, 1420403-00, 1420403-01, 1420403-02, 1420403B02, 1420509-01, 1422601-00, 1422602-00, 1520402-00, 1520402-01, 1520403-00, 1520403-01, 1522603-00, 1522603-01, 2020402-00, 2020402-01, 2020403-00, 2020403-01, 2020506-01, 2022601-00, 2022601-01, 2022603-00, 2022604-00, 2120402-00, 2120402-01, 2120403-00, 2120504-01, 2122601-00, 2122601-01, 2122602-00, 2122604-00, 2220403-00, 2220403-01, 2220403-02, 2222608-02, 2420403-00, 2420403-01...(Other models you can see in the webshop)		






## shut-off valves

### universal



<b>Part No.</b>	514482	<b>Ref. No.</b>	201077
<b>description</b>	shut-off valve connection 1/2" tap head 1/2" cold/warm total length 45mm		

<b>For models:</b>	1320401-00, 1320401-01, 1420401-00, 1420401-01, 1420405-00, 14228011-0, 14228022-0, 14228033-0, 14228044-0, 14228055-0, 2020401-00, 2020401-01, 2022801-00, 2022801-01, 20228011-0, 20228011-1, 2022801A00, 2022801A01, 2022801B00, 2022801B01, 2022801C00, 2022801C01, 2022802-00, 2022802-01, 20228022-0, 20228022-1, 2022802A00, 2022802A01, 2022802B00, 2022802B01, 2022802C00, 2022802C01, 2022803-00, 2022803-01, 20228033-0, 20228033-1, 2022803A00, 2022803A01, 2022803B00, 2022803B01, 2022803C00, 2022803C01, 2022804-00, 2022804-01, 20228044-0, 20228044-1, 2022804A00, 2022804A01, 2022804B00, 2022804B01... (Other models you can see in the webshop)		
--------------------	---	--	--





<b>spare parts for</b>	514482			
	<b>Part No.</b>	547951	<b>Ref. No.</b>	—
	tap head connection 3/4" without handle total lengthmm			


## steam valves



<b>Part No.</b>	541544	<b>Ref. No.</b>	201052
<b>description</b>	steam valve angled connection 1" IT - 1" ET total length 82mm H 136mm brass		

<b>For models:</b>	1412831-00, 1412832-00, 1412833-00, 1412834-00, 1412908-00, 1412910-00, 2012801-00, 2012801-01, 2012801A00, 2012801A01, 2012801B00, 2012801B01, 2012801C00, 2012801C01, 2012802-00, 2012802-01, 2012802A00, 2012802A01, 2012802B00, 2012802B01, 2012802B02, 2012802B03, 2012802B04, 2012802B05, 2012802B06, 2012802B07, 2012802C00, 2012802C01, 2012803-00, 2012803-01, 2012803A00, 2012803A01, 2012803B00, 2012803B01, 2012803C00, 2012803C01, 2012804-00, 2012804-01, 2012804A00, 2012804A01, 2012804B00, 2012804B01, 2012804B02, 2012804B03, 2012804B04, 2012804B05, 2012804B06, 2012804B07, 2012804C00, 2012804C01... (Other models you can see in the webshop)		
--------------------	---	--	--

<b>spare parts for</b>	541544			
	<b>Part No.</b>	540229	<b>Ref. No.</b>	—
	star handle shaft 9x9mm ø 80mm L 23mm black thermoplastic			
	<b>Part No.</b>	541546	<b>Ref. No.</b>	—
	screw chrome-plated brass thread M5 thread L 10mm			
	<b>Part No.</b>	541548	<b>Ref. No.</b>	—
	gasket PTFE ID ø 15mm H 7mm for thread 1 1/4" ED ø 35mm			
	<b>Part No.</b>	541554	<b>Ref. No.</b>	—
	gasket copper ext. ø 49 ID ø 42mm H 2mm for thread 1 1/4"			

<b>spare parts for</b>	541544			
	<b>Part No.</b>	541557	<b>Ref. No.</b>	—
	tap head chrome-plated thread 1 1/4" for steam tap 1"			

## tank inlets



<b>Part No.</b>	691607	<b>Ref. No.</b>	201006
<b>description</b>	tank inlet connection 1/2" WS 34 L1 20mm L2 34mm with non-return valve		
<b>For models:</b>	1320401-00, 1320401-01, 1420401-00, 1420401-01, 1420405-00, 2020401-00, 2020401-01, 2120401-00, 2120401-01		

## water cycle components

### supply filters



<b>Part No.</b>	692893	<b>Ref. No.</b>	201134
<b>description</b>	screen H 14mm ø 19.5mm plastic		
<b>For models:</b>	1422807B03, 1422807B04, 1422831-00, 1422832-00, 1422833-00, 1422834-00, 1422902-03, 1422902-04, 1422908-00, 1422910-00, 1423901-00, 1423901-01, 1423901-02, 1423902-00, 1423902-01, 1423902-02, 1423903-00, 1423903-01, 1423903-02, 1462831-00, 1462832-00, 1462833-00, 1462834-00, 1462835-00, 1462836-00, 1462837-00, 1462838-00, 1462839-00, 1462840-00, 1462908-00, 1462910-00, 2022802B08, 2022802B09, 2022802B10, 2022802C08, 2022802C09, 2022802C10, 2022802D00, 2022802D01, 2022802D02, 2022804B08, 2022804B09, 2022804B10, 2022804C08, 2022804C09, 2022804C10, 2022804D00, 2022804D01, 2022804D02, 2022805B08... (Other models you can see in the webshop)		

## ancillary products

### clamps

#### hose clamps

##### DIN 3017 - W2



<b>Part No.</b>	520113	<b>Ref. No.</b>	208045 W1 Stahl verzinkt 1 Stk
<b>description</b>	hose clamp ø 16-27mm width 9mm Qty 10 pcs DIN 3017		



DIN 3017 - W4



<b>Part No.</b>	520120	<b>Ref. No.</b>	208049
<b>description</b>	hose clamp SS W4 ø 12-20mm width 9mm Qty 1 pcs DIN 3017		
<b>For models:</b>	CCE60, CCE63, CGE11-L, CGE11-R, CGE12-L, CGE12-R, CGE21-L, CGE21-R, CGE22-L, CGE22-R, CGE61-L, CGE61-R, CGE62-L, CGE62-R, CGG11-L, CGG11-R, CGG12-L, CGG12-R, CGG21-L, CGG21-R, CGG22-L, CGG22-R, CGG61-L, CGG61-R, CGG62-L, CGG62-R, CPE60, CPE63, CSE11-L, CSE11-R, CSE11-R-DG, CSE12-L, CSE12-R, CSE12-R-DG, CSE21-L, CSE21-R, CSE21-R-DG, CSE22-L, CSE22-R, CSE22-R-DG, CSE61-L, CSE61-R, CSE61-R-DG, CSE62-L, CSE62-R, CSE62-R-DG, CSG11-L, CSG11-R, CSG11-R-DG, CSG12-L...(Other models you can see in the webshop)		

tools

hand tools

screwdrivers

nut spinners



<b>Part No.</b>	801436	<b>Ref. No.</b>	204206
<b>description</b>	nut spinner size 6x6mm total length 213mm blade length 125mm square		
<b>For models:</b>	0220301-00, 0220301B00, 0220301B01, 0220301B02, 0220302-00, 0220302A00, 0220302A01, 0220302A02, 0220302A03, 0220302B00, 0220302B01, 0220302B02, 0220302C00, 0220302C01, 0220302C02, 0220302C03, 0220302F00, 0220303-00, 0220303-01, 0220303A00, 0220303A01, 0220303A02, 0220303A03, 0220303B00, 0220303B01, 0220303C00, 0220303C01, 0220303C02, 0220304-00, 0220305-00, 0220306-00, 0220501-00, 0220502-00, 0220503-00, 0220802-00, 0221501-00, 0221502-00, 0260301-00, 0260301-01, 0260302-00, 0260302-01, 0260501-00, 0520303-00, 0520303-01, 0520303-02, 1020510-00, 1022603-00, 1220301-00, 1220301-01, 1220301-02...(Other models you can see in the webshop)		

measuring equipment

thermometers

built-in thermometers



<b>Part No.</b>	541411	<b>Ref. No.</b>	201562
<b>description</b>	thermometer mounting measurements 58x25.5mm 0 up to +250°C capillary pipe 2100mm probe ø 6mm probe L 200mm		
<b>For models:</b>	0260301-00, 0260301-01, 0260302-00, 0260302-01, 1260301-00, 1260301-01, 1260302-00, 1260302-01, 1460302-00, 1460302-01, 1460302-02, 2020303-00, 2020303-01, 2020303-02, 2020303-03, 2020303-04, 2020303A00, 2020310-00, 2020310-01, 2020310-02, 2020310-03, 2020310A00, 2020310A01, 2020310A02, 2020310A03, 2020311-00, 2020311-01, 2020311-02, 2020311-03, 2020311A00, 2020311A01, 2020311A02, 2020311A03, 2020339A00, 2020339A01, 2020340A00, 2020340A01, 2060301-00, 2060301-01, 2060301-02, 3020310-00, 3020310-01, 3020310A00, 3020310A01, 3020311-00, 3020311-01, 3020311A00, 3020311A01		

fastening material

rivets/rivet nuts

blind rivet nuts hexagonal



<b>Part No.</b>	551382	<b>Ref. No.</b>	208039
<b>description</b>	rivet nut thread M8 DN 11mm L 16.4mm SS Qty 1 pcs		
<b>For models:</b>	CGE11-L, CGE11-R, CGE12-L, CGE12-R, CGE21-L, CGE21-R, CGE22-L, CGE22-R, CGE61-L, CGE61-R, CGE62-L, CGE62-R, CGG11-L, CGG11-R, CGG12-L, CGG12-R, CGG21-L, CGG21-R, CGG22-L, CGG22-R, CGG61-L, CGG61-R, CGG62-L, CGG62-R, CSE11-L, CSE11-R, CSE11-R-DG, CSE12-L, CSE12-R, CSE12-R-DG, CSE21-L, CSE21-R, CSE21-R-DG, CSE22-L, CSE22-R, CSE22-R-DG, CSE61-L, CSE61-R, CSE61-R-DG, CSE62-L, CSE62-R, CSE62-R-DG, CSG11-L, CSG11-R, CSG11-R-DG, CSG12-L, CSG12-R, CSG12-R-DG, CSG21-L, CSG21-R...(Other models you can see in the webshop)		

screws

sheet metal screws



<b>Part No.</b>	560102	<b>Ref. No.</b>	111202
<b>description</b>	sheet metal screws ø 3.9mm L 9.5mm SS Qty 20 pcs DIN 7981/ISO 7049 head ø 7.5mm oval head		

countersunk screws




<b>Part No.</b>	560263	<b>Ref. No.</b>	105470
<b>description</b>	countersunk screw thread M4 L 25mm SS DIN 963/ISO 2009 Qty 20 pcs intake slotted head ø 7.5mm		
<b>For models:</b>	CGE21-L, CGE21-R, CGE22-L, CGE22-R, CGG11-L, CGG11-R, CGG12-L, CGG12-R, CGG21-L, CGG21-R, CGG22-L, CGG22-R, CGG61-L, CGG61-R, CGG62-L, CGG62-R, CSE21-L, CSE21-R, CSE21-R-DG, CSE22-L, CSE22-R, CSE22-R-DG, CSG11-L, CSG11-R, CSG11-R-DG, CSG12-L, CSG12-R, CSG12-R-DG, CSG21-L, CSG21-R, CSG21-R-DG, CSG22-L, CSG22-R, CSG22-R-DG, CSG61-L, CSG61-R, CSG61-R-DG, CSG62-L, CSG62-R, CSG62-R-DG		





<b>Part No.</b>	560425	<b>Ref. No.</b>	105466
<b>description</b>	countersunk screw thread M4 L 13mm stainless steel DIN 965/ISO 7046 Qty 1 pcs head ø 7.5mm		




flat-headed bolts

			
1			
<b>Part No.</b>	560635	<b>Ref. No.</b>	105008
<b>description</b>	flat-headed bolt thread M3 thread L 6mm with plain washer		
<b>For models:</b>	CCE60, CCE63, CGE11-L, CGE11-R, CGE12-L, CGE12-R, CGE21-L, CGE21-R, CGE22-L, CGE22-R, CGE61-L, CGE61-R, CGE62-L, CGE62-R, CGG11-L, CGG11-R, CGG12-L, CGG12-R, CGG21-L, CGG21-R, CGG22-L, CGG22-R, CGG61-L, CGG61-R, CGG62-L, CGG62-R, CPE60, CPE63, CSE11-L, CSE11-R, CSE11-R-DG, CSE12-L, CSE12-R, CSE12-R-DG, CSE21-L, CSE21-R, CSE21-R-DG, CSE22-L, CSE22-R, CSE22-R-DG, CSE61-L, CSE61-R, CSE61-R-DG, CSE62-L, CSE62-R, CSE62-R-DG, CSG11-L, CSG11-R, CSG11-R-DG, CSG12-L...(Other models you can see in the webshop)		


			
1			
<b>Part No.</b>	560626	<b>Ref. No.</b>	105001
<b>description</b>	flat-headed bolt thread M4 thread L 8mm head ø 8mm head thickness 3mm torx		
<b>For models:</b>	0021130A00, 0021130A01, 0021135A00, 0220601-00, 0521704-06, 0521704-07, 0521705-01, 0720325-03, 0720325-04, 0720325B03, 0720325B04, 0720332P00, 0720332R00, 0720332T00, 0720332V00, 0721134-01, 0721134A01, 0721172A01, 0721173A01, 0721174A01, 0721175A01, 0723104-03, 0723104A03, 0723104B03, 0723105-03, 0723105A03, 0723105B03, 0723405-01, 0723405-02, 0723409-01, 0723409-02, 0723412K01, 0723413-02, 0723414-02, 1003601-00, 1003602-00, 1020510-00, 1021130A00, 1021135A00, 1022512-00, 1022603-00, 1023101-00, 1023101-01, 1023106-00, 1023106-01, 1023111-00, 1023111-01, 1023401-00, 1023401K00, 1023410-00...(Other models you can see in the webshop)		

			
1			
<b>Part No.</b>	511004	<b>Ref. No.</b>	105115
<b>description</b>	flat-headed bolt thread M4 thread L 12mm SS DIN 84/ISO 1207 Qty 1 pcs intake slotted L 14.5mm		
<b>For models:</b>	0120101-00, 0120101-01, 0120101-02, 0120101-03, 0120101-04, 0120101C00, 0120101D00, 0120101D01, 0120101D02, 0120101D04, 0120105-00, 0120105-01, 0120105-02, 0120105-03, 0120105-04, 0120105C00, 0120105D00, 0120105D01, 0120105D02, 0120105D04, 0120201-00, 0120201-01, 0220301-00, 0220301B00, 0220301B01, 0220301B02, 0220301D00, 0220302-00, 0220302A00, 0220302A01, 0220302A02, 0220302A03, 0220302B00, 0220302B01, 0220302B02, 0220302C00, 0220302C01, 0220302C02, 0220302C03, 0220302D00, 0220302E00, 0220302E01, 0220302F00, 0220302H00, 0220302H01, 0220303-00, 0220303-01, 0220303A00, 0220303A01, 0220303A02...(Other models you can see in the webshop)		


			
1			
<b>Part No.</b>	560454	<b>Ref. No.</b>	105121
<b>description</b>	flat-headed bolt thread M4 thread L 22mm SS DIN 84/ISO 1207 Qty 1 pcs intake slotted head ø 7mm head thickness 2.5mm		
<b>For models:</b>	0220301-00, 0220301B00, 0220301B01, 0220301B02, 0220301D00, 0220302-00, 0220302A00, 0220302A01, 0220302A02, 0220302A03, 0220302B00, 0220302B01, 0220302B02, 0220302C00, 0220302C01, 0220302C02, 0220302C03, 0220302D00, 0220302E00, 0220302E01, 0220302F00, 0220303-00, 0220303-01, 0220303A00, 0220303A01, 0220303A02, 0220303A03, 0220303B00, 0220303B01, 0220303C00, 0220303C01, 0220303C02, 0220303D00, 0220303D01, 0220303E00, 0220303E01, 0220304-00, 0220305-00, 0220306-00, 0521704-0, 0521704-03, 0521704-04, 0521704-05, 0521704-06, 0521704-07, 0521704A01, 0521705-01, 1424814-01, 1424814A00, 1424815-01...(Other models you can see in the webshop)		

raised countersunk head screws


			
1			
<b>Part No.</b>	560627	<b>Ref. No.</b>	105466
<b>description</b>	raised countersunk head screw thread M4 thread L 12mm SS DIN 966/ISO 7047 Qty 1 pcs head thickness 3mm		
<b>For models:</b>	CCE60, CCE63, CGE11-L, CGE11-R, CGE12-L, CGE12-R, CGE21-L, CGE21-R, CGE22-L, CGE22-R, CGE61-L, CGE61-R, CGE62-L, CGE62-R, CGG11-L, CGG11-R, CGG12-L, CGG12-R, CGG21-L, CGG21-R, CGG22-L, CGG22-R, CGG61-L, CGG61-R, CGG62-L, CGG62-R, CPE60, CPE63, CSE11-L, CSE11-R, CSE11-R-DG, CSE12-L, CSE12-R, CSE12-R-DG, CSE21-L, CSE21-R, CSE21-R-DG, CSE22-L, CSE22-R, CSE22-R-DG, CSE61-L, CSE61-R, CSE61-R-DG, CSE62-L, CSE62-R, CSE62-R-DG, CSG11-L, CSG11-R, CSG11-R-DG, CSG12-L...(Other models you can see in the webshop)		


			
1			
<b>Part No.</b>	560634	<b>Ref. No.</b>	105471
<b>description</b>	raised countersunk head screw thread M4 thread L 40mm SS Qty 1 pcs intake slotted head ø 7.3mm		
<b>For models:</b>	CGE11-L, CGE11-R, CGE12-L, CGE12-R, CGE21-L, CGE21-R, CGE22-L, CGE22-R, CGE61-L, CGE61-R, CGE62-L, CGE62-R, CGG11-L, CGG11-R, CGG12-L, CGG12-R, CGG21-L, CGG21-R, CGG22-L, CGG22-R, CGG61-L, CGG61-R, CGG62-L, CGG62-R, CPE60, CPE63, CSE11-L, CSE11-R, CSE11-R-DG, CSE12-L, CSE12-R, CSE12-R-DG, CSE21-L, CSE21-R, CSE21-R-DG, CSE22-L, CSE22-R, CSE22-R-DG, CSE61-L, CSE61-R, CSE61-R-DG, CSE62-L, CSE62-R, CSE62-R-DG, CSG11-L, CSG11-R, CSG11-R-DG, CSG12-L, CSG12-R, CSG12-R-DG, CSG21-L, CSG21-R...(Other models you can see in the webshop)		


hexagonal screws


			
1			
<b>Part No.</b>	560311	<b>Ref. No.</b>	101451
<b>description</b>	hexagonal screw thread M10 thread L 20mm SS W5 17 Qty 1 pcs DIN 933 / ISO 4017		
<b>For models:</b>	CCE60, CGE11-L, CGE11-R, CGE12-L, CGE12-R, CGE21-L, CGE21-R, CGE22-L, CGE22-R, CGE61-L, CGE61-R, CGE62-L, CGE62-R, CGG11-L, CGG11-R, CGG12-L, CGG12-R, CGG21-L, CGG21-R, CGG22-L, CGG22-R, CGG61-L, CGG61-R, CGG62-L, CGG62-R, CPE60, CSE11-L, CSE11-R, CSE11-R-DG, CSE12-L, CSE12-R, CSE12-R-DG, CSE21-L, CSE21-R, CSE21-R-DG, CSE22-L, CSE22-R, CSE22-R-DG, CSE61-L, CSE61-R, CSE61-R-DG, CSE62-L, CSE62-R, CSE62-R-DG, CSG11-L, CSG11-R, CSG11-R-DG, CSG12-L, CSG12-R, CSG12-R-DG...(Other models you can see in the webshop)		



			
1			
<b>Part No.</b>	560081	<b>Ref. No.</b>	101412
<b>description</b>	hexagonal screw thread M4 thread L 10mm SS WS 7 Qty 20 pcs DIN 933 / ISO 4017		
<b>For models:</b>	0021130A00, 0021130A01, 0021135A00, 0120101-01, 0120101-02, 0120101-03, 0120101-04, 0120101D00, 0120101D01, 0120101D02, 0120101D04, 0120105-01, 0120105-02, 0120105-03, 0120105-04, 0120105D00, 0120105D01, 0120105D02, 0120105D04, 0221107-00, 0221107A00, 0221108-00, 0221109-00, 0221109A00, 0221110-00, 0263401-00, 0520302-01, 0520302-02, 0520302A00, 0520302A01, 0521702A03, 0521702A04, 0521704-00, 0521704-01, 0521704-02, 0521704-03, 0521704-04, 0521704-05, 0521704-06, 0521704-07, 0521704A00, 0521704A01, 0521705-00, 0521705-01, 0521706-00, 0522101-00, 0522101-01, 0522101-02, 0522101-03, 0522101-04... (Other models you can see in the webshop)		


			
1			
<b>Part No.</b>	560086	<b>Ref. No.</b>	101405
<b>description</b>	hexagonal screw thread M6 thread L 10mm SS WS 10 Qty 20 pcs DIN 933 / ISO 4017		


			
1			
<b>Part No.</b>	550682	<b>Ref. No.</b>	101435
<b>description</b>	hexagonal screw thread M8 thread L 20mm SS WS 13 Qty 1 pcs DIN 933 / ISO 4017		
<b>For models:</b>	CCE60, CCE63, CGE11-L, CGE11-R, CGE12-L, CGE12-R, CGE21-L, CGE21-R, CGE22-L, CGE22-R, CGE61-L, CGE61-R, CGE62-L, CGE62-R, CGG11-L, CGG11-R, CGG12-L, CGG12-R, CGG21-L, CGG21-R, CGG22-L, CGG22-R, CGG61-L, CGG61-R, CGG62-L, CGG62-R, CPE60, CPE63, CSE11-L, CSE11-R, CSE11-R-DG, CSE12-L, CSE12-R, CSE12-R-DG, CSE21-L, CSE21-R, CSE21-R-DG, CSE22-L, CSE22-R, CSE22-R-DG, CSE61-L, CSE61-R, CSE61-R-DG, CSE62-L, CSE62-R, CSE62-R-DG, CSG11-L, CSG11-R, CSG11-R-DG, CSG12-L... (Other models you can see in the webshop)		


			
2			
<b>Part No.</b>	560080	<b>Ref. No.</b>	101127
<b>description</b>	hexagonal screw thread M4 thread L 8mm SS WS 7 Qty 20 pcs DIN 933 / ISO 4017		
<b>For models:</b>	0263401-01, 0522101-02, 0522101-03, 0522102-02, 0522102-03, 0720325-03, 0720325-04, 0720325B03, 0720325B04, 1220301-00, 1220301-01, 1220301-02, 1220301-03, 1220301-04, 1220301B00, 1220301B01, 1220301B02, 1220301B03, 1220301B04, 1220301D00, 1220301D01, 1220301E00, 1220301E01, 1220301J00, 1220301J01, 1220301J02, 1220301J03, 1220302-00, 1220302-01, 1220302B00, 1220302B01, 1220302D00, 1220302E00, 1220303-00, 1220303-01, 1220303-02, 1220303-03, 1220303-04, 1220303-05, 1220303A00, 1220303A01, 1220303A02, 1220303A03, 1220303B00, 1220303B01, 1220303B02, 1220303B03, 1220303B04, 1220303B05, 1220303C00... (Other models you can see in the webshop)		


## cylinder head bolts

### DIN 912/ISO 4762

			
1			
<b>Part No.</b>	560305	<b>Ref. No.</b>	102008
<b>description</b>	cylinder head bolt thread M5 thread L 16mm WS 4 intake internal hexagon DIN 912/ISO 4762		
<b>For models:</b>	0720325-03, 0720325-04, 0720325B03, 0720325B04, 0720332P00, 0720332R00, 0720332T00, 0720332V00, 1220301-00, 1220301-01, 1220301-02, 1220301-03, 1220301-04, 1220301B00, 1220301B01, 1220301B02, 1220301B03, 1220301B04, 1220301D00, 1220301D01, 1220301E00, 1220301E01, 1220301J00, 1220301J01, 1220301J02, 1220301J03, 1220302-00, 1220302-01, 1220302B00, 1220302B01, 1220302D00, 1220302E00, 1220303-00, 1220303-01, 1220303-02, 1220303-03, 1220303-04, 1220303-05, 1220303A00, 1220303A01, 1220303A02, 1220303A03, 1220303B00, 1220303B01, 1220303B02, 1220303B03, 1220303B04, 1220303B05, 1220303C00, 1220303C01... (Other models you can see in the webshop)		


			
1			
<b>Part No.</b>	560083	<b>Ref. No.</b>	101125
<b>description</b>	hexagonal screw thread M5 thread L 10mm SS WS 8 Qty 20 pcs DIN 933 / ISO 4017		
<b>For models:</b>	0021130A00, 0021130A01, 0021135A00, 0263401-00, 0263401-01, 0521704-0, 0521704-00, 0521704-01, 0521704-02, 0521704-03, 0521704-04, 0521704-05, 0521704-06, 0521704-07, 0521704A00, 0521704A01, 0521705-00, 0521705-01, 0521706-00, 1121117-00, 1121117-01, 1121117A00, 1121118-00, 1121118-01, 1121119-00, 1121119A00, 1121120-00, 1121121-00, 1121121A00, 1121135A01, 1203603-00, 1204012-00, 1204012-01, 1204014-00, 1204014-01, 1204015-00, 1204015-01, 1204017-00, 1204017-01, 1204018-00, 1204018-01, 1204019-00, 1204019-01, 1220301-00, 1220301B00, 1220301D00, 1220301E00, 1220302-00, 1220302-01, 1220302B00... (Other models you can see in the webshop)		


			
1			
<b>Part No.</b>	520455	<b>Ref. No.</b>	102050
<b>description</b>	screw thread M8 thread L 20mm WS 6 SS Qty 1 pcs DIN 912/ISO 4762		
<b>For models:</b>	CGE11-L, CGE11-R, CGE12-L, CGE12-R, CGE61-L, CGE61-R, CGE62-L, CGE62-R, CGG11-L, CGG11-R, CGG12-L, CGG12-R, CGG61-L, CGG61-R, CGG62-L, CGG62-R, CSE11-L, CSE11-R, CSE11-R-DG, CSE12-L, CSE12-R, CSE12-R-DG, CSE61-L, CSE61-R, CSE61-R-DG, CSE62-L, CSE62-R, CSE62-R-DG, CSG11-L, CSG11-R, CSG11-R-DG, CSG12-L, CSG12-R, CSG12-R-DG, CSG61-L, CSG61-R, CSG61-R-DG, CSG62-L, CSG62-R, CSG62-R-DG		

			
1			
<b>Part No.</b>	560084	<b>Ref. No.</b>	101403
<b>description</b>	hexagonal screw thread M5 thread L 8mm SS WS 8 Qty 20 pcs DIN 933 / ISO 4017		
<b>For models:</b>	CCE60, CCE63, CGG11-L, CGG11-R, CGG12-L, CGG12-R, CGG21-L, CGG21-R, CGG22-L, CGG22-R, CGG61-L, CGG61-R, CGG62-L, CGG62-R, CPE60, CPE63, CSG11-L, CSG11-R, CSG11-R-DG, CSG12-L, CSG12-R, CSG12-R-DG, CSG21-L, CSG21-R, CSG21-R-DG, CSG22-L, CSG22-R, CSG22-R-DG, CSG61-L, CSG61-R, CSG61-R-DG, CSG62-L, CSG62-R, CSG62-R-DG		




side bolts

 <p>1</p>			
<b>Part No.</b>	560051	<b>Ref. No.</b>	118005
<b>description</b>	side bolts thread M4 L 16mm SS Qty 20 pcs intake slotted head ø 10mm		
<b>For models:</b>	0021130A00, 0021130A01, 0021135A00, 0120101-00, 0120101-01, 0120101-02, 0120101-03, 0120101-04, 0120101C00, 0120101D00, 0120101D01, 0120101D02, 0120101D04, 0120105-00, 0120105-01, 0120105-02, 0120105-03, 0120105-04, 0120105C00, 0120105D00, 0120105D01, 0120105D02, 0120105D04, 0120202-00, 0120202-01, 0120203-00, 0120203-01, 0203601-00, 0203602-00, 0203603-00, 0204601-00, 0220301-00, 0220301B00, 0220301B01, 0220301B02, 0220301D00, 0220302-00, 0220302A00, 0220302A01, 0220302A02, 0220302A03, 0220302B00, 0220302B01, 0220302B02, 0220302C00, 0220302C01, 0220302C02, 0220302C03, 0220302D00, 0220302E00... (Other models you can see in the webshop)		

 <p>1</p>			
<b>Part No.</b>	560053	<b>Ref. No.</b>	118009
<b>description</b>	side bolts thread M5 L 16mm SS Qty 20 pcs intake slotted head ø 12.5mm		
<b>For models:</b>	1203603-00, 1204012-00, 1204014-00, 1204015-00, 1204017-00, 1204018-00, 1204019-00, 1303703-00, 1303703-01, 1420309A01, 1420309A02, 1420309A03, 1420309C01, 1420309C02, 1420309C03, 1420310A01, 1420310A02, 1420310A03, 1420310A04, 1420310A05, 1420310C01, 1420310C02, 1420310C03, 1420310C04, 1420310C05, 1420325A00, 1420325A01, 1420325A02, 1420325A03, 1420325C00, 1420325C01, 1420325C02, 1420325C03, 1420327A00, 1420327A01, 1420327C00, 1420327C01, 1420329A00, 1420329A01, 1420329C00, 1420329C01, 1420330A00, 1420330A01, 1420330A02, 1420330A03, 1420330C00, 1420330C01, 1420330C02, 1420330C03, 1422807B00... (Other models you can see in the webshop)		


grub screws


miscellaneous


 <p>1</p>			
<b>Part No.</b>	560306	<b>Ref. No.</b>	110124
<b>description</b>	grub screw thread M6 L 10mm DIN 915 intake internal hexagon Qty 1 pcs		

nuts

cap nuts

 <p>1</p>			
<b>Part No.</b>	696820	<b>Ref. No.</b>	116064
<b>description</b>	cap nuts thread M10 IT WS 17 SS Qty 1 pcs DIN/ISO 917		
<b>For models:</b>	0522102-02, 0522102-03, 0522102-04, 14228011-0, 14228022-0, 14228033-0, 14228044-0, 14228055-0, 1462802B00, 1462804B00, 2012801-00, 2012801-01, 2012801A00, 2012801A01, 2012801B00, 2012801B01, 2012801C00, 2012801C01, 2012802-00, 2012802-01, 2012802A00, 2012802A01, 2012802B00, 2012802B01, 2012802C00, 2012802C01, 2012803-00, 2012803-01, 2012803A00, 2012803A01, 2012803B00, 2012803B01, 2012803C00, 2012803C01, 2012804-00, 2012804-01, 2012804A00, 2012804A01, 2012804B00, 2012804B01, 2012804C00, 2012804C01, 2012805-00, 2012805-01, 2012805A00, 2012805A01, 2012805B00, 2012805B01, 2012805C00, 2012805C01... (Other models you can see in the webshop)		

 <p>1</p>			
<b>Part No.</b>	696826	<b>Ref. No.</b>	116067
<b>description</b>	cap nuts thread M12 WS 19 SS Qty 1 pcs with bore		
<b>For models:</b>	CCE60, CCE63, CGE11-L, CGE11-R, CGE12-L, CGE12-R, CGE21-L, CGE21-R, CGE22-L, CGE22-R, CGE61-L, CGE61-R, CGE62-L, CGE62-R, CGG11-L, CGG11-R, CGG12-L, CGG12-R, CGG21-L, CGG21-R, CGG22-L, CGG22-R, CGG61-L, CGG61-R, CGG62-L, CGG62-R, CPE60, CPE63, CSE11-L, CSE11-R, CSE11-R-DG, CSE12-L, CSE12-R, CSE12-R-DG, CSE61-L, CSE61-R, CSE61-R-DG, CSE62-L, CSE62-R, CSE62-R-DG		

 <p>1</p>			
<b>Part No.</b>	696822	<b>Ref. No.</b>	116058
<b>description</b>	cap nuts thread M6 WS 10 SS Qty 1 pcs DIN/ISO 917		
<b>For models:</b>	0720332P00, 0720332R00, 0720332T00, 0720332V00, 1220301J02, 1220301J03, 1220303J03, 1220303J04, 1220303K00, 1220303K01, 1220305J03, 1220305J04, 1220305K02, 1220305K03, 1260302-00, 1260302-01, 1320401-01, 1420332P01, 1420332P02, 1420332P03, 1420332R00, 1420332R01, 1420332R02, 1420332R03, 1420332T01, 1420332T02, 1420332T03, 1420332V01, 1420332V02, 1420332V03, 1420333P01, 1420333P02, 1420333R00, 1420333R01, 1420333R02, 1420333T01, 1420333T02, 1420333V01, 1420333V02, 1420334P00, 1420334P01, 1420334P02, 1420334P03, 1420334P04, 1420334R02, 1420334R03, 1420334R04, 1420334T02, 1420334T03, 1420334T04... (Other models you can see in the webshop)		





## hexagonal nuts

DIN 934 / ISO 4032/8673



1

<b>Part No.</b>	560223	<b>Ref. No.</b>	113081
<b>description</b>	hexagonal nut thread M3 H 2.4mm WS 5.5 SS DIN/ISO DIN 934 / ISO 4032/8673 Qty 1 pcs		
<b>For models:</b>	0120201-01, 0120202-00, 0120202-01, 0120203-00, 0120203-01, 0220303A00, 0220303A01, 0220303A02, 0220303A03, 0220303C00, 0220303C01, 0220303C02, 0220306-00, 0260302-00, 0260302-01, 0521706-00, 1220303A00, 1220303A01, 1220303A02, 1220303A03, 1220303C00, 1220303C01, 1220303C02, 1220303C03, 1220303F01, 1220303F02, 1220303F03, 1220303H00, 1220303H01, 1220303H02, 1220303H03, 1220304A00, 1220304A01, 1220304A02, 1220304C00, 1220304C01, 1220304C02, 1220304F00, 1220304F01, 1220304H00, 1220304H01, 1220305A00, 1220305A01, 1220305A02, 1220305A03, 1220305A04, 1220305A05, 1220305C00, 1220305C01, 1220305C02... (Other models you can see in the webshop)		



1

<b>Part No.</b>	560197	<b>Ref. No.</b>	113096
<b>description</b>	nut thread M10 H 8mm WS 17 SS DIN/ISO DIN 934 / ISO 4032/8673 Qty 1 pcs		
<b>For models:</b>	1220301J02, 1220301J03, 1220303J03, 1220303J04, 1220303K00, 1220303K01, 1220305J03, 1220305J04, 1220305K02, 1220305K03, 2013003B01, 2013003B02, 2013003B03, 2013003B04, 2013003B05, 2013003B06, 2013004B01, 2013004B02, 2013004B03, 2013004B04, 2013004B05, 2013007B01, 2013007B02, 2013007B03, 2013007B04, 2013007B05, 2013007B06, 2013008B01, 2013008B02, 2013008B03, 2013008B04, 2013008B05, 2013009B01, 2013009B02, 2013009B03, 2013009B04, 2013009B05, 2013009B06, 2013010B01, 2013010B02, 2013010B03, 2013010B04, 2013010B05, 2013017B00, 2013017B01, 2013017B02, 2013017B03, 2013017B04, 2013017B05, 2013018B00... (Other models you can see in the webshop)		



1

<b>Part No.</b>	560340	<b>Ref. No.</b>	113082
<b>description</b>	hexagonal nut thread M4 H 3.2mm WS 7 SS DIN/ISO DIN 934 / ISO 4032/8673 Qty 1 pcs		
<b>For models:</b>	0021130A00, 0021130A01, 0021135A00, 0120101-00, 0120101-01, 0120101-02, 0120101-03, 0120101-04, 0120101C00, 0120101D00, 0120101D01, 0120101D02, 0120101D04, 0120105-00, 0120105-01, 0120105-02, 0120105-03, 0120105-04, 0120105C00, 0120105D00, 0120105D01, 0120105D02, 0120105D04, 0120201-00, 0120201-01, 0120202-00, 0120202-01, 0120203-00, 0120203-01, 0203603-00, 0220301-00, 0220301B00, 0220301B01, 0220301B02, 0220301D00, 0220302-00, 0220302A00, 0220302A01, 0220302A02, 0220302A03, 0220302B00, 0220302B01, 0220302B02, 0220302C00, 0220302C01, 0220302C02, 0220302C03, 0220302D00, 0220302E00, 0220302E01... (Other models you can see in the webshop)		



1

<b>Part No.</b>	517174	<b>Ref. No.</b>	113092
<b>description</b>	nut thread M8 H 6.5mm WS 13 SS DIN/ISO DIN 934 / ISO 4032/8673 Qty 1 pcs		
<b>For models:</b>	0261301-00, 0521704-00, 0521704-01, 0521704-02, 0521704-03, 0521704-04, 0521704-05, 0521704-06, 0521704-07, 0521704A00, 0521704A01, 0521705-00, 0521705-01, 0521706-00, 1223201-00, 1223201-01, 1223207-00, 1223207-01, 1261101-01, 1261101-02, 1261102-01, 1261102-02, 1323201-00, 1323201-01, 1323201-02, 1323207-00, 1323207-02, 1323208-00, 1323208-01, 1323208-03, 1323208-04, 1361101-01, 1361101-02, 1361101-03, 1361102-01, 1361102-02, 1361102-03, 1422802B04, 1422804B04, 1422805B04, 1422807B00, 1422902-00, 1424802-00, 1424802-01, 1424802-02, 1424808-00, 1424808-01, 1424808-02, 1424808-03, 1424809-00... (Other models you can see in the webshop)		



1

<b>Part No.</b>	560129	<b>Ref. No.</b>	113087 113088
<b>description</b>	hexagonal nut thread M5 H 4mm WS 8 SS DIN/ISO DIN 934 / ISO 4032/8673 Qty 1 pcs		

## DIN 985



1


<b>Part No.</b>	560227	<b>Ref. No.</b>	116041
<b>description</b>	hexagonal nut thread M3 H 4mm SS WS 5.5 Qty 1 pcs self-locking		
<b>For models:</b>	CCE60, CCE63, CGE11-L, CGE11-R, CGE12-L, CGE12-R, CGE21-L, CGE21-R, CGE22-L, CGE22-R, CGE61-L, CGE61-R, CGE62-L, CGE62-R, CGG11-L, CGG11-R, CGG12-L, CGG12-R, CGG21-L, CGG21-R, CGG22-L, CGG22-R, CGG61-L, CGG61-R, CGG62-L, CGG62-R, CPE60, CPE63, CSE11-L, CSE11-R, CSE11-R-DG, CSE12-L, CSE12-R, CSE12-R-DG, CSE21-L, CSE21-R, CSE21-R-DG, CSE22-L, CSE22-R, CSE22-R-DG, CSE61-L, CSE61-R, CSE61-R-DG, CSE62-L, CSE62-R, CSE62-R-DG, CSG11-L, CSG11-R, CSG11-R-DG, CSG12-L... (Other models you can see in the webshop)		





1


<b>Part No.</b>	511212	<b>Ref. No.</b>	113091
<b>description</b>	hexagonal nut thread M6 H 5mm WS 10 SS DIN/ISO DIN 934 / ISO 4032/8673 Qty 1 pcs		
<b>For models:</b>	0021130A00, 0021130A01, 0021135A00, 0203601-00, 0203602-00, 0203603-00, 0204601-00, 0220301-00, 0220301B00, 0220301B01, 0220301B02, 0220301D00, 0220302-00, 0220302A00, 0220302A01, 0220302A02, 0220302A03, 0220302B00, 0220302B01, 0220302B02, 0220302C00, 0220302C01, 0220302C02, 0220302C03, 0220302D00, 0220302E00, 0220302E01, 0220302F00, 0220302H00, 0220302H01, 0220303-00, 0220303-01, 0220303A00, 0220303A01, 0220303A02, 0220303A03, 0220303B00, 0220303B01, 0220303C00, 0220303C01, 0220303C02, 0220303D00, 0220303D01, 0220303E00, 0220303E01, 0220303H00, 0220303H01, 0220304-00, 0220305-00, 0220306-00... (Other models you can see in the webshop)		





			
1			
<b>Part No.</b>	560140	<b>Ref. No.</b>	113014 116042
<b>description</b>	hexagonal nut thread M4 H 4.8mm SS WS 7 Qty 20 pcs DIN/ISO DIN 985 self-locking		
<b>For models:</b>	CCE60, CCE63, CGE11-L, CGE11-R, CGE12-L, CGE12-R, CGE21-L, CGE21-R, CGE22-L, CGE22-R, CGE61-L, CGE61-R, CGE62-L, CGE62-R, CGG11-L, CGG11-R, CGG12-L, CGG12-R, CGG21-L, CGG21-R, CGG22-L, CGG22-R, CGG61-L, CGG61-R, CGG62-L, CGG62-R, CPE60, CPE63, CSE11-L, CSE11-R, CSE11-R-DG, CSE12-L, CSE12-R, CSE12-R-DG, CSE21-L, CSE21-R, CSE21-R-DG, CSE22-L, CSE22-R, CSE22-R-DG, CSE61-L, CSE61-R, CSE61-R-DG, CSE62-L, CSE62-R, CSE62-R-DG, CSG11-L, CSG11-R, CSG11-R-DG, CSG12-L, CSG12-R, CSG12-R-DG, CSG21-L, CSG21-R, CSG21-R-DG, CSG22-L, CSG22-R, CSG22-R-DG, CSG61-L, CSG61-R, CSG62-L, CSG62-R, CSG62-R-DG		


			
2			
<b>Part No.</b>	560141	<b>Ref. No.</b>	116061
<b>description</b>	hexagonal nut thread M5 H 5.4mm SS WS 8 Qty 20 pcs DIN/ISO DIN 985 self-locking		
<b>For models:</b>	CCE60, CCE63, CGG11-L, CGG11-R, CGG12-L, CGG12-R, CGG21-L, CGG21-R, CGG22-L, CGG22-R, CGG61-L, CGG61-R, CGG62-L, CGG62-R, CPE60, CPE63, CSG11-L, CSG11-R, CSG11-R-DG, CSG12-L, CSG12-R, CSG12-R-DG, CSG21-L, CSG21-R, CSG21-R-DG, CSG22-L, CSG22-R, CSG22-R-DG, CSG61-L, CSG61-R, CSG62-L, CSG62-R, CSG62-R-DG		

			
1			
<b>Part No.</b>	560142	<b>Ref. No.</b>	116063
<b>description</b>	hexagonal nut thread M6 H 6mm SS WS 10 Qty 20 pcs DIN/ISO DIN 985 self-locking		
<b>For models:</b>	CCE60, CCE63, CGE11-L, CGE11-R, CGE12-L, CGE12-R, CGE21-L, CGE21-R, CGE22-L, CGE22-R, CGE61-L, CGE61-R, CGE62-L, CGE62-R, CGG11-L, CGG11-R, CGG12-L, CGG12-R, CGG21-L, CGG21-R, CGG22-L, CGG22-R, CGG61-L, CGG61-R, CGG62-L, CGG62-R, CPE60, CPE63, CSE11-L, CSE11-R, CSE11-R-DG, CSE12-L, CSE12-R, CSE12-R-DG, CSE61-L, CSE61-R, CSE61-R-DG, CSE62-L, CSE62-R, CSE62-R-DG, CSG11-L, CSG11-R, CSG11-R-DG, CSG12-L, CSG12-R, CSG12-R-DG, CSG21-L, CSG21-R, CSG21-R-DG, CSG22-L, CSG22-R, CSG22-R-DG, CSG61-L, CSG61-R, CSG62-L, CSG62-R, CSG62-R-DG		

			
1			
<b>Part No.</b>	560143	<b>Ref. No.</b>	121124
<b>description</b>	hexagonal nut thread M8 H 8.5mm SS WS 13 Qty 20 pcs DIN/ISO DIN 985 self-locking		
<b>For models:</b>	2012827-00, 2012827-01, 2012827-02, 2012828-00, 2012828-01, 2012828-02, 2012828-03, 2012828-04, 2012828-05, 2012829-00, 2012829-01, 2012829-02, 2022827-00, 2022827-01, 2022828-01, 2022828-02, 2022828-03, 2022828-04, 2022828-05, 2022828-06, 2022829-00, 2022829-01, 2061603-00, 2061603-01, 2061603-02, 3012827-00, 3012827-01, 3012827-02, 3012828-00, 3012828-01, 3012828-02, 3012828-03, 3012828-04, 3012828-05, 3012829-00, 3012829-01, 3012829-02, 3022827-00, 3022827-01, 3022828-03, 3022828-04, 3022828-05, 3022828-06, 3022828-07, 3022829-00, 3022829-01, CCE60, CCE63, CGE11-L, CGE11-R...(Other models you can see in the webshop)		

			
1			
<b>Part No.</b>	560653	<b>Ref. No.</b>	113097
<b>description</b>	nut thread M12 H 6mm SS WS 19 Qty 1 pcs DIN/ISO 439		
<b>For models:</b>	CCE60, CCE63, CGE11-L, CGE11-R, CGE12-L, CGE12-R, CGE21-L, CGE21-R, CGE22-L, CGE22-R, CGE61-L, CGE61-R, CGE62-L, CGE62-R, CGG11-L, CGG11-R, CGG12-L, CGG12-R, CGG21-L, CGG21-R, CGG22-L, CGG22-R, CGG61-L, CGG61-R, CGG62-L, CGG62-R, CPE60, CPE63, CSE11-L, CSE11-R, CSE11-R-DG, CSE12-L, CSE12-R, CSE12-R-DG, CSE61-L, CSE61-R, CSE61-R-DG, CSE62-L, CSE62-R, CSE62-R-DG, CSG11-L, CSG11-R, CSG11-R-DG, CSG12-L, CSG12-R, CSG12-R-DG, CSG21-L, CSG21-R, CSG21-R-DG, CSG22-L, CSG22-R, CSG22-R-DG, CSG61-L, CSG61-R, CSG62-L, CSG62-R, CSG62-R-DG		

			
1			
<b>hexagonal nuts metric (without norm)</b>			
<b>Part No.</b>	521101	<b>Ref. No.</b>	113000
<b>description</b>	nut thread M14x1.5 H 5mm WS 19 SS Qty 1 pcs		
<b>For models:</b>	00217022-0, 0120101-00, 0120101-01, 0120101-02, 0120101-03, 0120101-04, 0120101C00, 0120101D00, 0120101D01, 0120101D02, 0120101D04, 0120105-00, 0120105-01, 0120105-02, 0120105-03, 0120105-04, 0120105C00, 0120105D00, 0120105D01, 0120105D02, 0120105D04, 0120201-00, 0120201-01, 0120202-00, 0120202-01, 0120203-00, 0120203-01, 0220301-00, 0220301B00, 0220301B01, 0220301B02, 0220301D00, 0220302-00, 0220302A00, 0220302A01, 0220302A02, 0220302A03, 0220302B00, 0220302B01, 0220302B02, 0220302C00, 0220302C01, 0220302C02, 0220302C03, 0220302D00, 0220302E00, 0220302E01, 0220302F00, 0220302H00, 0220302H01... (Other models you can see in the webshop)		

			
1			
<b>Part No.</b>	102067	<b>Ref. No.</b>	201524
<b>description</b>	nut thread M8x1 H 3mm brass Qty 1 pcs type SEF 1		
<b>For models:</b>	0260301-00, 0260302-00, 0260501-00, 0261101-00, 0261101-01, 0261102-00, 0261102-01, 0261103-00, 0261103-01, 0261301-00, 0261601-00, 0263401-00, 0263401-01, 1263401-00, 1263402-00, 1263402-01, 1263402-02, 1263404-00, 1263404-01, 1263404-02, 1263405-00, 1263405-01, 1263413-02, 1263414-02, 1363401-00, 1363402-00, 1363402-01, 1363403-00, 1363403-01, 1363403-02, 1363403-03, 1363403-04, 1363403-05, 1363404-00, 1363404-01, 1363404-02, 1363404-03, 1363405-00, 1363405-01, 1363413-03, 1363415-05, 14621011-0, 1462831-00, 1462832-00, 1462833-00, 1462834-00, 1462835-00, 1462836-00, 1462837-00... (Other models you can see in the webshop)		



## miscellaneous



1

Part No.	560548	Ref. No.	208025
description	nut thread M4 Qty 1 pcs		
For models:	0021130A00, 0021130A01, 0021135A00, 02211107-00, 0221107A00, 0221108-00, 0221109-00, 0221109A00, 0221110-00, 0521702-01, 0521702-02, 0521702-03, 0521702-04, 0521702A02, 0521702A03, 0521702A04, 0521702B03, 0521702B04, 0521702C04, 0521704-04, 0521704-05, 0521704-06, 0521704-07, 0522101-03, 0522101-04, 0522102-03, 0522102-04, 0721134-01, 0721134A01, 0721172A01, 0721173A01, 0721174A01, 0721175A01, 0722101-06, 0723412K01, 1003601-00, 1003602-00, 1020510-00, 1021130A00, 1021135A00, 1022512-00, 1022603-00, 1023101-00, 1023101-01, 1023106-00, 1023106-01, 1023111-00, 1023111-01, 1023401-00, 1023401K00... (Other models you can see in the webshop)		

## washers

## spring rings



1

Part No.	560655	Ref. No.	121035
description	lock washer ID ø 10.5mm ext. ø 18.1mm max. spring steel DIN 127A Qty 1 pcs for thread M10		
For models:	1412831-00, 1412832-00, 1412833-00, 1412833-01, 1412834-00, 1412834-01, 1412908-00, 1412910-00, 1412910-01, 1422701-00, 1422701-01, 1422701-02, 1422701-03, 1422702-00, 1422702-01, 1422702-02, 1422702-03, 1422703-00, 1422703-01, 1422703-02, 1422704-00, 1422704-01, 1422704-02, 1422705-00, 1422705-01, 1422705-02, 1422706-00, 1422706-01, 1422706-02, 1422707-00, 1422707-01, 1422707-02, 1422708-00, 1422708-01, 1422708-02, 1422807B00, 1422807B01, 1422807B02, 1422807B03, 1422807B04, 1422831-00, 1422832-00, 1422833-00, 1422834-00, 1422902-00, 1422902-01, 1422902-02, 1422902-03, 1422902-04, 1422908-00... (Other models you can see in the webshop)		



1

Part No.	560657	Ref. No.	121030
description	lock washer ID ø 3.1mm ext. ø 6.2mm max. spring steel DIN 127A Qty 1 pcs for thread M3		
For models:	0120201-01, 0120202-00, 0120202-01, 0120203-00, 0120203-01, 0260302-00, 0260302-01, 0520303-02, 1420309A01, 1420309A02, 1420309C01, 1420309C02, 1420310A01, 1420310A02, 1420310A03, 1420310C01, 1420310C02, 1420310C03, 1424824-00, 1424824-01, 1462802B01, 1462802B02, 1462802B03, 1462802B04, 1462802B05, 1462804B01, 1462804B02, 1462804B03, 1462804B04, 1462804B05, 1462831-00, 1462832-00, 1462833-00, 1462834-00, 1462835-00, 1462836-00, 1462837-00, 1462838-00, 1462839-00, 1462840-00, 1462908-00, 1462910-00, 1463501-03, 1463501-04, 1463501-05, 2020301A01, 2020301A02, 2020301C01, 2020301C02, 2020302A01... (Other models you can see in the webshop)		



1

Part No.	560122	Ref. No.	121032
description	lock washer ID ø 5.2mm ED ø 9mm SS DIN127 Qty 20 pcs for thread M5		
For models:	0021130A00, 0021130A01, 0021135A00, 0221101-01, 0221101A01, 0221102-01, 0221103-01, 0221104-01, 0221104A01, 0221105-01, 0221106-01, 0261101-01, 0261102-01, 0261103-01, 0263401-00, 0263401-01, 0521704-0, 0521704-00, 0521704-01, 0521704-02, 0521704-03, 0521704-04, 0521704-05, 0521704-06, 0521704-07, 0521704A00, 0521704A01, 0521705-00, 0521705-01, 0521706-00, 0522101-00, 0522101-02, 0522101-03, 0522101-04, 0522102-00, 0522102-02, 0522102-03, 0522102-04, 0720325-03, 0720325-04, 0720325B03, 0720325B04, 0720332P00, 0720332R00, 0720332T00, 0720332V00, 0722101-06, 1023101-01, 1023106-01, 1023111-01... (Other models you can see in the webshop)		



1

Part No.	560656	Ref. No.	121034
description	lock washer ID ø 8.1mm ext. ø 14.8mm max. spring steel DIN 127A Qty 1 pcs for thread M8		
For models:	0120101-00, 0120101-01, 0120101-02, 0120101-03, 0120101C00, 0120101D00, 0120101D01, 0120101D02, 0120105-00, 0120105-01, 0120105-02, 0120105-03, 0120105C00, 0120105D00, 0120105D01, 0120105D02, 0521704-0, 0521704-00, 0521704-01, 0521704-02, 0521704-03, 0521704-04, 0521704-05, 0521704-06, 0521704-07, 0521704A00, 0521704A01, 0521705-00, 0521705-01, 0521706-00, 1223201-00, 1223201-01, 1223207-00, 1223207-01, 1323201-00, 1323201-01, 1323201-02, 1323207-00, 1323207-02, 1323208-00, 1323208-01, 1323208-03, 1323208-04, 1422701-00, 1422702-00, 1422802B04, 1422802B05, 1422804B04, 1422804B05, 1422805B04... (Other models you can see in the webshop)		

## washers


## DIN 125A





1


Part No.	560110	Ref. No.	120005
description	plain washer ID ø 3.2mm ED ø 7mm thickness 0.5mm SS Qty 20 pcs DIN 125A for thread M3		
For models:	0220302A03, 0220302C03, 0220302H01, 0220303A00, 0220303A01, 0220303A02, 0220303A03, 0220303C00, 0220303C01, 0220303C02, 0220303H01, 0220306-00, 0520303-02, 0521706-00, 1220303A00, 1220303A01, 1220303A02, 1220303A03, 1220303C00, 1220303C01, 1220303C02, 1220303C03, 1220303F01, 1220303F02, 1220303F03, 1220303H00, 1220303H01, 1220303H02, 1220303H03, 1220305A00, 1220305A01, 1220305A02, 1220305A03, 1220305A04, 1220305A05, 1220305C00, 1220305C01, 1220305C02, 1220305C03, 1220305C04, 1220305C05, 1220305F01, 1220305F02, 1220305F03, 1220305F04, 1220305F05, 1220305H00, 1220305H01, 1220305H02, 1220305H03... (Other models you can see in the webshop)		





			
1			
<b>Part No.</b>	560111	<b>Ref. No.</b>	120017
<b>description</b>	plain washer ID $\phi$ 4.3mm ED $\phi$ 9mm thickness 0.8mm SS Qty 20 pcs DIN 125A for thread M4		
<b>For models:</b>	0021130A00, 0021130A01, 0021135A00, 0120101-01, 0120101-02, 0120101-03, 0120101-04, 0120101D00, 0120101D01, 0120101D02, 0120101D04, 0120105-01, 0120105-02, 0120105-03, 0120105-04, 0120105D00, 0120105D01, 0120105D02, 0120105D04, 0203603-00, 0220301-00, 0220301B00, 0220301B01, 0220301B02, 0220301D00, 0220302-00, 0220302A00, 0220302A01, 0220302A02, 0220302A03, 0220302B00, 0220302B01, 0220302B02, 0220302C00, 0220302C01, 0220302C02, 0220302C03, 0220302D00, 0220302E00, 0220302E01, 0220302F00, 0220302H00, 0220302H01, 0220303-00, 0220303-01, 0220303A00, 0220303A01, 0220303A02, 0220303A03, 0220303B00... (Other models you can see in the webshop)		


			
1			
<b>Part No.</b>	560114	<b>Ref. No.</b>	120108
<b>description</b>	plain washer ID $\phi$ 8.4mm ED $\phi$ 16mm thickness 1.6mm SS Qty 20 pcs DIN 125A for thread M8		
<b>For models:</b>	0120101-00, 0120101-01, 0120101-02, 0120101-03, 0120101C00, 0120101D00, 0120101D01, 0120101D02, 0120105-00, 0120105-01, 0120105-02, 0120105-03, 0120105C00, 0120105D00, 0120105D01, 0120105D02, 0521704-0, 0521704-00, 0521704-01, 0521704-02, 0521704-03, 0521704-04, 0521704-05, 0521704-06, 0521704-07, 0521704A00, 0521704A01, 0521705-00, 0521705-01, 0521706-00, 1220402-00, 1220402-01, 1220504-01, 1222601-00, 1222603-00, 1223201-00, 1223201-01, 1223207-00, 1223207-01, 1261101-00, 1261101-01, 1261101-02, 1261102-00, 1261102-01, 1261102-02, 1320402-00, 1320402-01, 1320504-01, 1320504-02, 1322601-00... (Other models you can see in the webshop)		


			
2			
<b>Part No.</b>	560112	<b>Ref. No.</b>	120022
<b>description</b>	plain washer ID $\phi$ 5.3mm ED $\phi$ 10mm thickness 1mm SS Qty 20 pcs DIN 125A for thread M5		
<b>For models:</b>	0221101-01, 0221101A01, 0221102-01, 0221103-01, 0221104-01, 0221104A01, 0221105-01, 0221106-01, 0261101-01, 0261102-01, 0261103-01, 0521706-00, 0522101-00, 0522101-02, 0522101-03, 0522101-04, 0522102-00, 0522102-02, 0522102-03, 0522102-04, 0722101-06, 0723104-03, 0723104A03, 0723104B03, 0723105-03, 0723105A03, 0723105B03, 1203603-00, 1204001-00, 1204001-01, 1204002-00, 1204002-01, 1204003-00, 1204003-01, 1204004-00, 1204004-01, 1204005-00, 1204005-01, 1204006-00, 1204006-01, 1204007-00, 1204007-01, 1204008-00, 1204008-01, 1204009-00, 1204009-01, 1204012-01, 1204014-01, 1204015-01, 1204017-01... (Other models you can see in the webshop)		

<b>DIN 9021</b>			
			
1			
<b>Part No.</b>	560304	<b>Ref. No.</b>	945104
<b>description</b>	plain washer ID $\phi$ 10.5mm ED $\phi$ 25mm Qty 1 pcs for thread M9		

			
1			
<b>Part No.</b>	560303	<b>Ref. No.</b>	120030
<b>description</b>	plain washer ID $\phi$ 6.4mm ED $\phi$ 18mm Qty 1 pcs for thread M6		
<b>For models:</b>	0021130A00, 0021130A01, 0021135A00, 0220301-00, 0220301B00, 0220301B01, 0220301B02, 0220301D00, 0220302-00, 0220302A00, 0220302A01, 0220302A02, 0220302A03, 0220302B00, 0220302B01, 0220302B02, 0220302C00, 0220302C01, 0220302C02, 0220302C03, 0220302D00, 0220302E00, 0220302E01, 0220302F00, 0220302H00, 0220302H01, 0220303-00, 0220303-01, 0220303A00, 0220303A01, 0220303A02, 0220303A03, 0220303B00, 0220303B01, 0220303C00, 0220303C01, 0220303C02, 0220303D00, 0220303D01, 0220303E00, 0220303E01, 0220303H00, 0220303H01, 0261101-01, 0261102-01, 0261103-01, 0263401-00, 0263401-01, 0521701-00, 0521701-01... (Other models you can see in the webshop)		

			
1			
<b>Part No.</b>	560333	<b>Ref. No.</b>	120027
<b>description</b>	plain washer ID $\phi$ 6.4mm ED $\phi$ 12mm thickness 1.6mm SS Qty 1 pcs DIN 125A for thread M6		
<b>For models:</b>	0021130A00, 0021130A01, 0021135A00, 0203601-00, 0203602-00, 0203603-00, 0204601-00, 0220301-00, 0220301B00, 0220301B01, 0220301B02, 0220301D00, 0220302-00, 0220302A00, 0220302A01, 0220302A02, 0220302A03, 0220302B00, 0220302B01, 0220302B02, 0220302C00, 0220302C01, 0220302C02, 0220302C03, 0220302D00, 0220302E00, 0220302E01, 0220302F00, 0220302H00, 0220302H01, 0220303-00, 0220303-01, 0220303A00, 0220303A01, 0220303A02, 0220303A03, 0220303B00, 0220303B01, 0220303C00, 0220303C01, 0220303C02, 0220303D00, 0220303D01, 0220303E00, 0220303E01, 0220303H00, 0220303H01, 0220304-00, 0220305-00, 0220306-00... (Other models you can see in the webshop)		

<b>nylon</b>			
			
1			
<b>Part No.</b>		<b>Ref. No.</b>	120007
<b>description</b>	plain washer ID $\phi$ 12.5mm ED $\phi$ 28mm thickness 3mm nylon Qty 1 pcs		
<b>For models:</b>	CCE60, CCE63, CPE60, CPE63		

			
1			
<b>Part No.</b>	560645	<b>Ref. No.</b>	120008
<b>description</b>	plain washer ID $\phi$ 7.4mm ED $\phi$ 14mm thickness 1.6mm SS Qty 1 pcs DIN 125A		
<b>For models:</b>	CCE60, CCE63, CGG11-L, CGG11-R, CGG12-L, CGG12-R, CGG21-L, CGG21-R, CGG22-L, CGG22-R, CGG61-L, CGG61-R, CGG62-L, CGG62-R, CPE60, CPE63, CSG11-L, CSG11-R, CSG11-R-DG, CSG12-L, CSG12-R, CSG12-R-DG, CSG21-L, CSG21-R, CSG21-R-DG, CSG22-L, CSG22-R, CSG22-R-DG, CSG61-L, CSG61-R, CSG61-R-DG, CSG62-L, CSG62-R, CSG62-R-DG		



## tooth lock washers

## DIN 6798A



<b>Part No.</b>	560125	<b>Ref. No.</b>	121023
<b>description</b>	tooth lock washer ID ø 4.2mm ED ø 8mm SS DIN/ISO DIN 6798A Qty 20 pcs for thread M4		
<b>For models:</b>	0720332P00, 0720332R00, 0720332T00, 0720332V00, 1220301-02, 1220301-03, 1220301-04, 1220301B02, 1220301B03, 1220301B04, 1220301J01, 1220301J03, 1220303-03, 1220303-04, 1220303-05, 1220303B03, 1220303B04, 1220303B05, 1220303I02, 1220303J02, 1220303J04, 1220303K01, 1220307-01, 1220326-01, 1220326B01, 1220327-00, 1220327-01, 1220327B01, 1220329-00, 1220329-01, 1220329B00, 1220329B01, 1220402-00, 1220402-01, 1320323-00, 1320323B00, 1320327-00, 1320327A01, 1320327A02, 1320327B00, 1320327C01, 1320327C02, 1320327Z00, 1320327Z01, 1320329-00, 1320329-01, 1320329A01, 1320329A02, 1320329B00, 1320329B01... (Other models you can see in the webshop)		

## miscellaneous



<b>Part No.</b>	560654	<b>Ref. No.</b>	121210
<b>description</b>	tooth lock washer ID ø 12.5mm ED ø 20.5mm spring steel DIN/ISO 6797 Qty 1 pcs for thread M12		
<b>For models:</b>	0220501-00, 0220502-00, 0220503-00, 0220802-00, 0522101-00, 0522101-02, 0522101-03, 0522102-00, 0522102-02, 0522102-03, 1323208-00, 1323208-01, 1323208-02, 1323208-03, 1323210-00, 1323210-01, 1323210-02, 1363403-00, 1363403-01, 1363403-02, 1420501-00, 1420502-00, 1420504-00, 1420505-00, 1420801-00, 1420803-00, 1422101-00, 1422101-02, 1422101-03, 1422102-00, 1422102-02, 1422102-03, 14621011-0, 1820501-00, 18208011-0, 2020501-00, 2020501-01, 20205011-0, 2020502-00, 20205033-0, 2020504-00, 2020505-00, 2023203-00, 2023203-03, 2023203-04, 2023203-05, 2023203-06, 2023203A00, 2023203A03, 2023205-00... (Other models you can see in the webshop)		

## fasteners

## clamps

## hose clamps

## DIN 3017 - W2



<b>Part No.</b>	520113	<b>Ref. No.</b>	208045 W1 Stahl verzinkt 1 Stk
<b>description</b>	hose clamp ø 16-27mm width 9mm Qty 10 pcs DIN 3017		

## DIN 3017 - W4



<b>Part No.</b>	520120	<b>Ref. No.</b>	208049
<b>description</b>	hose clamp SS W4 ø 12-20mm width 9mm Qty 1 pcs DIN 3017		
<b>For models:</b>	CCE60, CCE63, CGE11-L, CGE11-R, CGE12-L, CGE12-R, CGE21-L, CGE21-R, CGE22-L, CGE22-R, CGE61-L, CGE61-R, CGE62-L, CGE62-R, CGG11-L, CGG11-R, CGG12-L, CGG12-R, CGG21-L, CGG21-R, CGG22-L, CGG22-R, CGG61-L, CGG61-R, CGG62-L, CGG62-R, CPE60, CPE63, CSE11-L, CSE11-R, CSE11-R-DG, CSE12-L, CSE12-R, CSE12-R-DG, CSE21-L, CSE21-R, CSE21-R-DG, CSE22-L, CSE22-R, CSE22-R-DG, CSE61-L, CSE61-R, CSE61-R-DG, CSE62-L, CSE62-R, CSE62-R-DG, CSG11-L, CSG11-R, CSG11-R-DG, CSG12-L... (Other models you can see in the webshop)		

## miscellaneous



<b>Part No.</b>	521185	<b>Ref. No.</b>	208065
<b>description</b>	hose clamp ø 50-70mm width 12mm Qty 1 pcs		
<b>For models:</b>	815156, 815157, 815166, 815167, CCE60, CCE63, CGE11-L, CGE11-R, CGE12-L, CGE12-R, CGE21-L, CGE21-R, CGE22-L, CGE22-R, CGE61-L, CGE61-R, CGE62-L, CGE62-R, CGG11-L, CGG11-R, CGG12-L, CGG12-R, CGG21-L, CGG21-R, CGG22-L, CGG22-R, CGG61-L, CGG61-R, CGG62-L, CGG62-R, CPE60, CPE63, CSE11-L, CSE11-R, CSE11-R-DG, CSE12-L, CSE12-R, CSE12-R-DG, CSE21-L, CSE21-R, CSE21-R-DG, CSE22-L, CSE22-R, CSE22-R-DG, CSE61-L, CSE61-R, CSE61-R-DG, CSE62-L, CSE62-R, CSE62-R-DG... (Other models you can see in the webshop)		

## roll pins



<b>Part No.</b>	696825	<b>Ref. No.</b>	123004
<b>description</b>	roll pin ø 5mm L 10mm spring steel DIN 1481		
<b>For models:</b>	CGE11-L, CGE11-R, CGE12-L, CGE12-R, CGE21-L, CGE21-R, CGE22-L, CGE22-R, CGE61-L, CGE61-R, CGE62-L, CGE62-R, CGG11-L, CGG11-R, CGG12-L, CGG12-R, CGG21-L, CGG21-R, CGG22-L, CGG22-R, CGG61-L, CGG61-R, CGG62-L, CGG62-R, CSE11-L, CSE11-R, CSE11-R-DG, CSE12-L, CSE12-R, CSE12-R-DG, CSE21-L, CSE21-R, CSE21-R-DG, CSE22-L, CSE22-R, CSE22-R-DG, CSE61-L, CSE61-R, CSE61-R-DG, CSE62-L, CSE62-R, CSE62-R-DG, CSG11-L, CSG11-R, CSG11-R-DG, CSG12-L, CSG12-R, CSG12-R-DG, CSG21-L, CSG21-R... (Other models you can see in the webshop)		





			
1			
<b>Part No.</b>	696824	<b>Ref. No.</b>	123005
<b>description</b>	roll pin ø 5mm L 16mm spring steel DIN 1481		
<b>For models:</b>	CGE11-L, CGE11-R, CGE12-L, CGE12-R, CGE21-L, CGE21-R, CGE22-L, CGE22-R, CGE61-L, CGE61-R, CGE62-L, CGE62-R, CGG11-L, CGG11-R, CGG12-L, CGG12-R, CGG21-L, CGG21-R, CGG22-L, CGG22-R, CGG61-L, CGG61-R, CGG62-L, CGG62-R, CSE11-L, CSE11-R, CSE11-R-DG, CSE12-L, CSE12-R, CSE12-R-DG, CSE21-L, CSE21-R, CSE21-R-DG, CSE22-L, CSE22-R, CSE22-R-DG, CSE61-L, CSE61-R, CSE61-R-DG, CSE62-L, CSE62-R, CSE62-R-DG, CSG11-L, CSG11-R, CSG11-R-DG, CSG12-L, CSG12-R, CSG12-R-DG, CSG21-L, CSG21-R...(Other models you can see in the webshop)		


<p>pins</p> 			
1			
<b>Part No.</b>	696823	<b>Ref. No.</b>	123027
<b>description</b>	pin ø 5mm L 10mm SS Qty 1 pcs		
<b>For models:</b>	CGE11-L, CGE11-R, CGE12-L, CGE12-R, CGE21-L, CGE21-R, CGE22-L, CGE22-R, CGE61-L, CGE61-R, CGE62-L, CGE62-R, CGG11-L, CGG11-R, CGG12-L, CGG12-R, CGG21-L, CGG21-R, CGG22-L, CGG22-R, CGG61-L, CGG61-R, CGG62-L, CGG62-R, CSE11-L, CSE11-R, CSE11-R-DG, CSE12-L, CSE12-R, CSE12-R-DG, CSE21-L, CSE21-R, CSE21-R-DG, CSE22-L, CSE22-R, CSE22-R-DG, CSE61-L, CSE61-R, CSE61-R-DG, CSE62-L, CSE62-R, CSE62-R-DG, CSG11-L, CSG11-R, CSG11-R-DG, CSG12-L, CSG12-R, CSG12-R-DG, CSG21-L, CSG21-R...(Other models you can see in the webshop)		

			
1			
<b>Part No.</b>	696827	<b>Ref. No.</b>	123034
<b>description</b>	pin ø 5mm L 20mm steel Qty 1 pcs		
<b>For models:</b>	CGE11-L, CGE11-R, CGE12-L, CGE12-R, CGE21-L, CGE21-R, CGE22-L, CGE22-R, CGE61-L, CGE61-R, CGE62-L, CGE62-R, CGG11-L, CGG11-R, CGG12-L, CGG12-R, CGG21-L, CGG21-R, CGG22-L, CGG22-R, CGG61-L, CGG61-R, CGG62-L, CGG62-R, CSE11-L, CSE11-R, CSE11-R-DG, CSE12-L, CSE12-R, CSE12-R-DG, CSE21-L, CSE21-R, CSE21-R-DG, CSE22-L, CSE22-R, CSE22-R-DG, CSE61-L, CSE61-R, CSE61-R-DG, CSE62-L, CSE62-R, CSE62-R-DG, CSG11-L, CSG11-R, CSG11-R-DG, CSG12-L, CSG12-R, CSG12-R-DG, CSG21-L, CSG21-R...(Other models you can see in the webshop)		

## consumables

### sealants and adhesives


#### high temperature silicone

			
1			
<b>Part No.</b>	890060	<b>Ref. No.</b>	303046
<b>description</b>	adhesive PACTAN 6076 310ml 250°C anthracite		
<b>description</b>	<p>PACTAN 6076 - cartridge 310ml - anthracite</p> <p>1-component silicone-based product for specific gluing and sealing purposes that require a high temperature resistance. The material is used for bonding and sealing of parts with high temperature load e.g. inner door of oven as well as for other bonding and sealing purposes especially on ovens and ranges. The product is fast to light, resistant to ageing and ozone and reveals a very good chemical resistance.</p> <p>Temperature resistance up to 250°C</p>		
<b>For models:</b>	0720332P00, 0720332R00, 0720332T00, 0720332V00, 0723104-03, 0723104A03, 0723104B03, 0723105-03, 0723105A03, 0723105B03, 1023101-00, 1023101-01, 1023106-00, 1023106-01, 1023111-00, 1023111-01, 1023401-00, 1023401K00, 1023410-00, 1220301J02, 1220301J03, 1220303J03, 1220303J04, 1220303K00, 1220303K01, 1223101-00, 1223101-01, 1223101-02, 1223103-00, 1223103-01, 1223103-02, 1223106-00, 1223106-01, 1223106-02, 1223202-00, 1223202A00, 1223202A01, 1223202J00, 1223202J01, 1223203-00, 1223203-01, 1223203-02, 1223203-03, 1223204-00, 1223204-01, 1223204-02, 1223205-00, 1223205-01, 1223205-02, 1223206-00... (Other models you can see in the webshop)		

### cleaning agents


#### combi-steamer detergents/descalers

*Notice: Articles labelled 'DANGEROUS GOODS' are delivered by road through a forwarder for reasons of safety and are charged separately!*

			
1			
<b>Part No.</b>	802061	<b>Ref. No.</b>	303324 40-100575
<b>description</b>	detergent for combi-steamer MKN WaveClean detergent/rinse aid Qty 10 pcs		
<b>description</b>	<p>MKN WaveClean - detergent - box of 10 cartridges</p> <p>Combination product for cleaning and descaling of combi steamers with WaveClean®</p> <p>Innovative 2-in-1 cartridge with cleaner and rinse aid. Easy handling with no direct contact to active agents. Cleans MKN combi steamers reliably, economically and hygienically. Start the WaveClean® cleaning program, unscrew the 2-in-1 cartridge cap and insert the cartridge into the holder when prompted to do so. After the cleaning process remove the cartridge before starting the machine. Rinse off any residue with plenty of water. For commercial use only.</p>		





## lava rocks / ceramic briquetts


			
1			
<b>Part No.</b>	211100	<b>Ref. No.</b>	201517
<b>description</b>	ceramic briquetts size 53x53x24		
<b>For models:</b>	0261601-00, 1261601-00, 1261601-01, 1261602-00, 1261602-01, 1261602-02, 1261602-03, 1261604-03, 1361601-00, 1361601-01, 1361601-02, 1361602-00, 1361602-01, 1361602-02, 1361604-02, 1461601-00, 1461602-00, 2061602-00, 2061602-01, 2061603-00, 2061603-01, 2061603-02, 2061604-01, 3061602-00		


## fuses


## fine fuses


			
1			
<b>Part No.</b>	358598	<b>Ref. No.</b>	202776
<b>description</b>	fine fuse size ø5x20mm 0.63A slow-acting rated 250V Qty 10 pcs		
<b>For models:</b>	0720332R00, 0720332V00		


			
1			
<b>Part No.</b>	358599	<b>Ref. No.</b>	203720
<b>description</b>	fine fuse size ø5x20mm 0.8A slow-acting rated 250V Qty 10 pcs		
<b>For models:</b>	0521702B03, 0521702B04, 2022828-01, 2022828-02, 2022828-03, 2022828-04, 2022828-05, 2022828-06, 3022828-03, 3022828-04, 3022828-05, 3022828-06, 3022828-07, CGE11-L, CGE11-R, CGE12-L, CGE12-R, CGE21-L, CGE21-R, CGE22-L, CGE22-R, CGE61-L, CGE61-R, CGE62-L, CGE62-R, CPE63, CSE11-L, CSE11-R, CSE12-L, CSE12-R, CSE21-L, CSE21-R, CSE22-L, CSE22-R, CSE61-L, CSE61-R, CSE62-L, CSE62-R		

			
1			
<b>Part No.</b>	358601	<b>Ref. No.</b>	203722
<b>description</b>	fine fuse size ø5x20mm 1.25A slow-acting rated 250V Qty 10 pcs		
<b>For models:</b>	CCE60, CCE63, CGE12-L, CGE12-R, CGE62-L, CGE62-R, CGG11-L, CGG11-R, CGG12-L, CGG12-R, CGG21-L, CGG21-R, CGG22-L, CGG22-R, CGG61-L, CGG61-R, CGG62-L, CGG62-R, CPE60, CPE63, CSE12-L, CSE12-R, CSE62-L, CSE62-R, CSG11-L, CSG11-R, CSG11-R-DG, CSG12-L, CSG12-R, CSG12-R-DG, CSG21-L, CSG21-R, CSG21-R-DG, CSG22-L, CSG22-R, CSG22-R-DG, CSG61-L, CSG61-R, CSG61-R-DG, CSG62-L, CSG62-R, CSG62-R-DG		


			
1			
<b>Part No.</b>	358608	<b>Ref. No.</b>	203996
<b>description</b>	fine fuse size ø5x20mm 10A slow-acting rated 250V Qty 10 pcs		
<b>For models:</b>	CGE11-L, CGE11-R, CGE12-L, CGE12-R, CGE21-L, CGE21-R, CGE22-L, CGE22-R, CGE61-L, CGE61-R, CGE62-L, CGE62-R, CGG11-L, CGG11-R, CGG12-L, CGG12-R, CGG21-L, CGG21-R, CGG22-L, CGG22-R, CGG61-L, CGG61-R, CGG62-L, CGG62-R, CPE63, CSE11-L, CSE11-R, CSE11-R-DG, CSE12-L, CSE12-R, CSE12-R-DG, CSE21-L, CSE21-R, CSE21-R-DG, CSE22-L, CSE22-R, CSE22-R-DG, CSE61-L, CSE61-R, CSE61-R-DG, CSE62-L, CSE62-R, CSE62-R-DG, CSG11-L, CSG11-R, CSG11-R-DG, CSG12-L, CSG12-R, CSG12-R-DG, CSG21-L...(Other models you can see in the webshop)		

			
1			
<b>Part No.</b>	358603	<b>Ref. No.</b>	203474
<b>description</b>	fine fuse size ø5x20mm 2A slow-acting rated 250V Qty 10 pcs		
<b>For models:</b>	0220302A00, 0220302A01, 0220302A02, 0220302A03, 0220302C00, 0220302C01, 0220302C02, 0220302C03, 0220303A00, 0220303A01, 0220303A02, 0220303A03, 0220303B00, 0220303B01, 0220303C00, 0220303C01, 0220303C02, 0220303E00, 0220303E01, 0220304-00, 0220305-00, 0220306-00, 0221501-00, 0221502-00, 0720332P00, 0720332R00, 0720332T00, 0720332V00, 1220307-00, 1220307-01, 1220308-00, 1220326-00, 1220326-01, 1220326B00, 1220326B01, 1220327-00, 1220327-01, 1220327B01, 1220329-00, 1220329-01, 1220329B00, 1220329B01, 1221112-00, 1320323-00, 1320323B00, 1320327-00, 1320327A00, 1320327A01, 1320327A02, 1320327B00...(Other models you can see in the webshop)		

			
1			
<b>Part No.</b>	358605	<b>Ref. No.</b>	203742
<b>description</b>	fine fuse size ø5x20mm 3.15A slow-acting rated 250V Qty 10 pcs		


			
1			
<b>Part No.</b>	358607	<b>Ref. No.</b>	203473
<b>description</b>	fine fuse size ø5x20mm 6.3A slow-acting rated 250V Qty 10 pcs		
<b>For models:</b>	1422701-01, 1422701-02, 1422701-03, 1422702-01, 1422702-02, 1422702-03, 1422802B04, 1422802B05, 1422802B06, 1422802B07, 1422802B08, 1422804B04, 1422804B05, 1422804B06, 1422804B07, 1422804B08, 1422805B04, 1422805B05, 1422805B06, 1422805B07, 1422805B08, 1422807B00, 1422807B01, 1422807B02, 1422807B03, 1422807B04, 1422902-00, 1422902-01, 1422902-02, 1422902-03, 1422902-04, 2013004B01, 2013004B02, 2013004B03, 2013004B04, 2013004B05, 2013008B01, 2013008B02, 2013008B03, 2013008B04, 2013008B05, 2013010B01, 2013010B02, 2013010B03, 2013010B04, 2013010B05, 2013018B00, 2013018B01, 2013018B02, 2013018B03...(Other models you can see in the webshop)		



			
1			
<b>Part No.</b>	358704	<b>Ref. No.</b>	203741
<b>description</b>	fine fuse size ø5x20mm 8A slow-acting rated 250V Qty 10 pcs		

screw locks

D0-system (NEOZED)

			
1			
<b>Part No.</b>	358045	<b>Ref. No.</b>	203739
<b>description</b>	fuse size D02 35A rated 250/400V E18 ø 15mm L 36mm Qty 10 pcs		
<b>For models:</b>	CGE21-L, CGE21-R, CGG11-L, CGG11-R, CGG12-L, CGG12-R, CGG61-L, CGG61-R, CSE12-L, CSE12-R, CSE12-R-DG, CSE21-L, CSE21-R, CSE21-R-DG, CSG11-L, CSG11-R, CSG11-R-DG		

**GASTRO**PARTS.COM

