



GASTROPARTS

Metos

- [EN]** Equipment
- [DE]** Geräte
- [ES]** Aparatos
- [FR]** Équipement
- [IT]** Attrezzature
- [PL]** Urządzenia
- [RU]** Оборудование

✉ gastroparts@gastroparts.com

☎ tel. +48 56 657 00 66

📘 fb.com/gastroparts.global

GASTROPARTS.COM







heating elements

heating elements for ovens



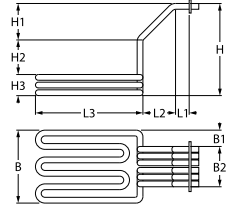

			
Part No.	418025	Ref. No.	826620041
description	heating element 1500W 230V L 525mm W 240mm lug length 70mm lug width 22mm hole distance 56mm hole ø 5mm tube ø 6.3mm connection male faston 6.3mm heating circuits 1 dry heating element rectangular flange oven		
For models:	94-04CEE, 94-04CGE, 94-04CGE1P, 94-04CGEP, 94-04CTEES, 94-04CTGE, 94-04VTCE, 96-04CGE, 96-04CGE2P, 96-04CGEE, 96-04CGEE2P, 96-04CGEEP, 96-04CGEP, 96-04CTGEDX, 96-04CTGESX, 98-04CGE, 98-04CGE2P, 98-04CGEP, 98-04CTGE		

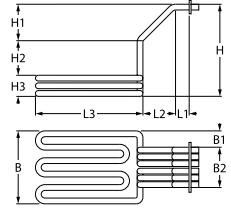
heating elements for fryers

 			
Part No.	420063	Ref. No.	9000481
description	heating element 13000W 230/400V heating circuits 3 L 385mm W 200mm H 245mm L1 40mm L2 30mm L3 315mm W1 53mm W2 94mm H1 40mm H2 170mm H3 35mm rectangular flange hole distance 122mm hole ø 6mm flange length 132mm immersion heater flange width 38mm tube ø 8.5mm		
For models:	72-02FREM, 74-02FREM		
accessories for	420063		
		Part No.	551114 Ref. No. —
	gasket L 131mm W 42mm silicone thickness 1mm for heating element		

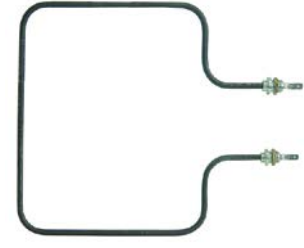
 			
Part No.	420526	Ref. No.	9000480
description	heating element 9000W 230V heating circuits 3 L 390mm W 135mm H 230mm L1 50mm L2 40mm L3 315mm W1 20mm W2 94mm H1 105mm H2 170mm H3 35mm threaded hole distance 122mm		
For models:	73-02FREM		

heating elements for heated cabinets

			
Part No.	416787	Ref. No.	6A036800
description	heating element 420W 230V heating circuits 1 L 265mm W 245mm connection male faston 6.3mm tube ø 6.3mm 2 hole fixing thread 1/4" dry heating element heated cabinet L1 60mm L2 185mm W1 82mm W2 70mm mounting distance 64mm		
For models:	76-02CTGGE		
accessories for	416787		
		Part No.	361182 Ref. No. —
	nut thread 1/4" H 5mm nickel-plated brass WS 17 Qty 1 pcs		
		Part No.	510417 Ref. No. —
	flat gasket fibre ED ø 20mm ID ø 14mm thickness 2mm Qty 1 pcs		
		Part No.	520228 Ref. No. —
	tooth lock washer ID ø 15.3mm ED ø 24mm steel Qty 1 pcs for thread M14		
		Part No.	550262 Ref. No. —
	flat gasket copper ED ø 20mm ID ø 14mm thickness 2mm		

immersion heating elements

3 hole flange ø47.5mm

group 6

			
Part No.	419060	Ref. No.	6A001421
description	heating element 8000W 230V heating circuits 3 L 320mm W 34mm H 39mm tube ø 8.5mm thermostat sleeves ø 7.5mm length thermostat sleeves 210mm number of thermostat sleeves 1 thermostat sleeve eccentric, clinging connection M4 connection length 22mm immersion heater 3 hole flange L1 60mm L3 255mm H1 35mm H2 5mm mounting ø 47.5mm		
For models:	94-04PEI100L		



3 hole flange ø57.5mm

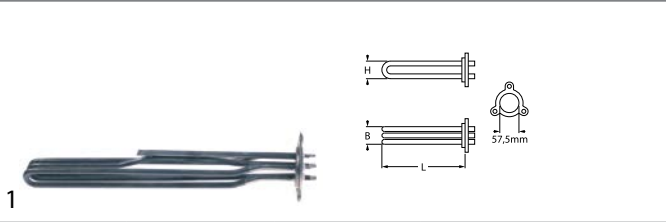

Part No.	418714	Ref. No.	6A037190
description	heating element 6000W 230V heating circuits 3 L 385mm W 37mm H 60mm tube ø 8.5mm thermostat sleeves ø 7.5mm length thermostat sleeves 210mm number of thermostat sleeves 1 thermostat sleeve eccentric, clinging connection male faston 6.3mm immersion heater 3 hole flange hole distance 75mm mounting ø 57.5mm hole ø 8x10mm		
For models:	74-02NPEI		



Part No.	418112	Ref. No.	6A037484
description	heating element 15000W 220V heating circuits 6 L 310mm W 230mm H 130mm thermostat sleeves ø 6/4mm length thermostat sleeves 137/125mm number of thermostat sleeves 2 thermostat sleeve clinging / not clinging connection male faston 6.3mm immersion heater		
For models:	NECVM10ES2, NECVM10GS2, NECVM20ES2, NECVM20GS2, NECVM21ES2, NECVM21GS2, NECVP10ES2, NECVP10GS2, NECVP20ES2, NECVP20GS2, NECVP21ES2, NECVP21GS2		
spare parts for	418112		
	Part No.	375638	Ref. No. —
	bi-metal thermostat hole distance 23.5mm 1NC 1-pole connection F6.3 2 hole fixing		
accessories for	418112		
	Part No.	550692	Ref. No. 6A037485
	gasket silicone thickness 7mm ID ø 193.7mm Qty 1 pcs for heating element suitable for BARON equiv. no. A037485		



Part No.	418111	Ref. No.	6A037483
description	heating element 7500W 220V heating circuits 6 L 310mm W 145mm H 130mm thermostat sleeves ø 6x4mm length thermostat sleeves 137/125mm number of thermostat sleeves 2 thermostat sleeve clinging / not clinging connection male faston 6.3mm immersion heater special fixing		
For models:	NECVM6ES2, NECVM6GS2, NECVP6ES2, NECVP6GS2		
accessories for	418111		
	Part No.	550692	Ref. No. 6A037485
	gasket silicone thickness 7mm ID ø 193.7mm Qty 1 pcs for heating element suitable for BARON equiv. no. A037485		

miscellaneous

Part No.	420443	Ref. No.	5315199
description	heating element 9000W 230-400V heating circuits 3 L 75mm W 72mm H 75mm tube ø 8.5mm thermostat sleeves ø 7mm length thermostat sleeves 325mm thermostat sleeve centre number of thermostat sleeves 1 connection M4 boiler screw mounting warewashing flange ø 135mm		

Part No.	420444	Ref. No.	5315388
description	heating element 1800W 230V heating circuits 1 L 205mm W 58mm H 18mm thread M14x1 mounting distance 60mm tube ø 8.5mm tank warewashing		

heating elements for convection

Part No.	418110	Ref. No.	6A037470
description	heating element 10500W 230V heating circuits 3 ID ø 370mm ED ø 384mm L 405mm H 141mm L1 20mm W1 105mm H1 41mm H2 100mm flange length 142mm flange width 25mm hole distance 63mm connection M5 tube ø 6.5mm convection heating element hole ø 6mm rectangular flange		
For models:	NECVM20ES2, NECVP20ES2		



			
1			
Part No.	418107	Ref. No.	6A037460
description	heating element 7500W 230V heating circuits 3 ID ø 368mm ED ø 385mm L 405mm H 135mm L1 24mm W1 105mm H1 35mm H2 100mm flange length 142mm flange width 24mm hole distance 64mm connection M5 connection length 92mm tube ø 8.5mm convection heating element hole ø 5.5mm rectangular flange		
For models:	NECVM10ES2, NECVM21ES2, NECVM6ES2, NECVP10ES2, NECVP21ES2, NECVP6ES2		

			
1			
Part No.	418108	Ref. No.	6A037480
description	heating element 7500W 230V heating circuits 3 ID ø 475mm ED ø 495mm L 515mm H 143mm L1 15mm W1 105mm H1 43mm H2 100mm flange length 142mm flange width 25mm hole distance 64mm connection M4 tube ø 8.5mm convection heating element hole ø 6mm rectangular flange		
For models:	NECVM10ES2, NECVM21ES2, NECVP10ES2, NECVP21ES2		

			
1			
Part No.	418109	Ref. No.	6A037475
description	heating element 9000W 230V heating circuits 3 ID ø 470mm ED ø 485mm L 520mm H 155mm L1 18mm W1 104mm H1 50mm H2 105mm flange length 142mm flange width 25mm hole distance 63mm connection M5 tube ø 6.5mm convection heating element hole ø 6.3mm rectangular flange		
For models:	NECVM20ES2, NECVP20ES2		

radiation heaters

square

			
1			
Part No.	490202	Ref. No.	826620230
description	radiation heater L 300mm W 300mm 4000W 400V H 40mm connection type screw with pan detection		
For models:	94-04CTEES, 94-04CTES, 94-04TCTES		

1-circuit

			
1			
Part No.	490150	Ref. No.	6A036750
description	radiation heater ø 250mm 2500W 230V heating circuits 1 energy regulation with temperature signalization with heating coil connections 2+2 connection type male faston 6.3mm EGO		
For models:	74-02CTE, 74-02CTEE, 74-02TCTE		

2-circuit

			
1			
Part No.	490139	Ref. No.	6A001401
description	radiation heater ø 250mm 2500W 230V heating circuits 2 energy regulation with temperature signalization partial power 1000W with ribbon heater connections 3+2 connection type male faston 6.3mm EGO		
For models:	72-02TVTCV, 72-02VTCV, 74-02TVTCV, 74-02VTCEV, 74-02VTCV		

accessories

sealing washers

fibre gaskets

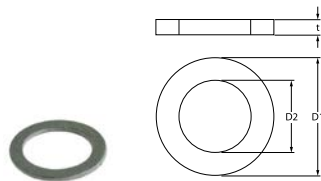
			
1			
Part No.	510404	Ref. No.	6A022280
description	flat gasket fibre ED ø 44mm ID ø 34mm thickness 2mm Qty 1 pcs		
For models:	74-02NPEI		



O-rings

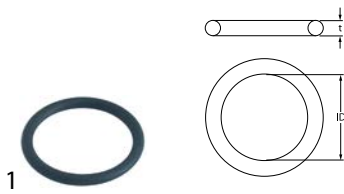

Part No.	505092	Ref. No.	BN0119472130
description	O-ring EPDM thickness 5.34mm ID ø 43.82mm Qty 1 pcs		

miscellaneous

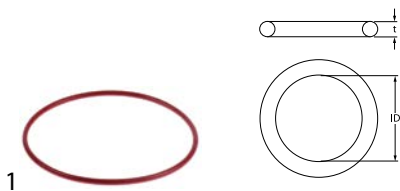

Part No.	550692	Ref. No.	6A037485
description	gasket silicone thickness 7mm ID ø 193.7mm Qty 1 pcs for heating element suitable for BARON equiv. no. A037485		
For models:	NECVM10ES2, NECVM10GS2, NECVM20ES2, NECVM20GS2, NECVM21ES2, NECVM21GS2, NECVM6ES2, NECVM6GS2, NECVP10ES2, NECVP10GS2, NECVP20ES2, NECVP20GS2, NECVP21ES2, NECVP21GS2, NECVP6ES2, NECVP6GS2		

capillary tube clips



Part No.	550980	Ref. No.	8208270
description	capillary tube clip for pipe ø 8.5mm Qty 1 pcs		
For models:	72-02FREM, 73-02FREM, 74-02FREM		

spring clips



Part No.	550981	Ref. No.	8208260
description	probe clip for pipe ø 8.5mm for probe ø 6mm for heating elements spacing 0.4mm Qty 1 pcs		
For models:	72-02FREM, 73-02FREM, 74-02FREM		

hot plates

square & rectangular

with radiused edge



Part No.	490056 ¹	Ref. No.	6A036530
description	hot plate dimensions 300x300mm 3000W 230V with spill ring connection 4 screw clamps protector yes square		
For models:	92-04CE, 92-04TCE, 94-04CE, 94-04CEE, 94-04TCE		

¹incl. protector

energy regulators

EGO

1-circuit



Part No.	380015	Ref. No.	3016217 6A049320
description	energy regulator 230V 13A single-circuit turn direction right shaft ø 6x4.6mm shaft L 23mm mounting thread M4 power release 6-100% no. 50.57021.010		
For models:	74-02CTE, 74-02CTEE, 74-02NPEI, 74-02TCTE, CVP6E		

2-circuit



Part No.	380027	Ref. No.	6A001402
description	energy regulator EGO 230V 13A dual circuit turn direction right shaft ø 6x4.6mm shaft L 23mm mounting thread M4 power release 6-70% no. 50.55021.100		
For models:	72-02TVTCV, 72-02VTCV, 74-02TVTCV, 74-02VTCEV, 74-02VTCV, 92-04TVTC, 92-04VTC, 94-04TVTC, 94-04VTC, 94-04VTCE		



thermostats

bi-metal thermostats

bi-metal thermostats



Part No.	390613	Ref. No.	6A035210
description	bi-metal thermostat hole distance 23.5mm switch-off temp. 150°C 1NCA connection F6.3		
For models:	72-02TVTCV, 72-02VTCV, 74-02TVTCV, 74-02VTCEV, 74-02VTCV, 92-04TVTC, 92-04VTC, 94-04TVTC, 94-04VTC, 94-04VTCE		



Part No.	390612	Ref. No.	6A035200
description	bi-metal thermostat hole distance 24mm switch-off temp. 110°C		
For models:	72-02TVTCV, 72-02VTCV, 74-02TVTCV, 74-02VTCEV, 74-02VTCV, 92-04TVTC, 92-04VTC, 94-04TVTC, 94-04VTC, 94-04VTCE		

control and safety thermostats

EGO

control thermostats

55.10/19_series

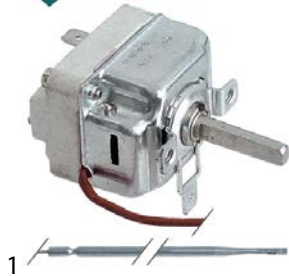

Part No.	375363	Ref. No.	6A001414
description	thermostat t.max. 161°C temperature range 73-161°C 1-pole 1NO 16A probe ø 3mm probe L 144mm capillary pipe 1600mm capillary pipe isolated 1600mm gland nut shaft ø 6x4.6mm shaft L 23mm shaft position upper rotation 270°		
For models:	94-04PEI100L, 94-04PEI150L		

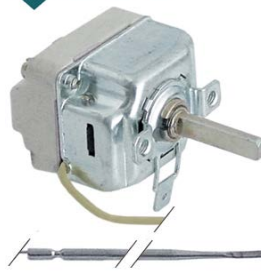

Part No.	375382	Ref. No.	6A049200
description	thermostat t.max. 295°C temperature range 45-295°C 1-pole 1NO 16A probe ø 3mm probe L 219mm capillary pipe 1300mm capillary pipe isolated 350mm gland nut shaft ø 6x4.6mm shaft L 23mm rotation 270°		
For models:	74-02KBGB, 74-02KBGBI, 74-02KBGMB, 74-02KBGMBI		



Part No.	375381	Ref. No.	6A046050
description	thermostat t.max. 90°C temperature range 30-90°C 1-pole 1NO 16A probe ø 6mm probe L 130mm capillary pipe 2000mm capillary pipe isolated 2000mm gland nut shaft ø 6x4.6mm shaft L 23mm shaft position upper rotation 270°		
For models:	76-02CTGGE		

55.34_series



Part No.	375384	Ref. No.	6A044601
description	thermostat t.max. 275°C temperature range 50-275°C 3-pole 3NO 16A probe ø 3mm probe L 219mm capillary pipe 900mm capillary pipe isolated 900mm gland nut shaft ø 6x4.6mm shaft L 23mm shaft position lower rotation 318° probe material SS		
For models:	74-02CTEE, 74-02CTGE, 74-02VTCEV		



E-G-O

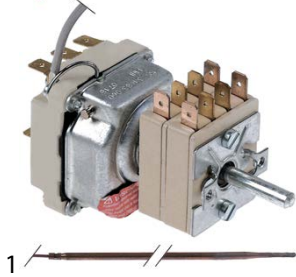

Part No.	375917	Ref. No.	6A046130
description	thermostat t.max. 550°C temperature range 85-500/85-550°C 3-pole 2NO/1NO 16A probe ø 3.9mm probe L 228mm capillary pipe 1110mm capillary pipe isolated 600mm gland nut shaft ø 6x4.6mm shaft L 23mm rotation 318° outer switch 2NO/2NO		
For models:	94-04CTEES		

E-G-O



Part No.	375364	Ref. No.	6A001415
description	safety thermostat switch-off temp. 190°C 3-pole 20A probe ø 4mm probe L 120mm capillary pipe 3000mm capillary pipe isolated 3000mm gland nut probe		
For models:	94-04PEI100L, 94-04PEI150L		

safety thermostats

55.13_ series

E-G-O

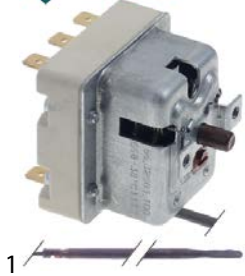

Part No.	375936	Ref. No.	6A046140
description	safety thermostat switch-off temp. 658°C 3-pole 3NC probe ø 4mm probe L 160mm capillary pipe 1210mm capillary pipe isolated 790mm gland nut probe		
For models:	94-04CTEES		

E-G-O

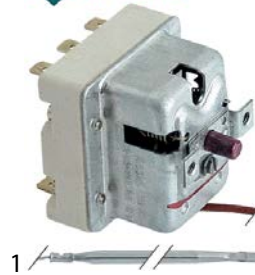

Part No.	375312	Ref. No.	8219602
description	safety thermostat switch-off temp. 245°C 3-pole 3NC 20A probe ø 4mm probe L 120mm capillary pipe 1800mm capillary pipe isolated 1800mm gland nut probe SS		
For models:	72-02FREM, 73-02FREM, 74-02FREM		
accessories for	375312		
	Part No.	550981	Ref. No. 8208260
	probe clip for pipe ø 8.5mm for probe ø 6mm for heating elements spacing 0.4mm Qty 1 pcs		

55.32_ series

E-G-O



Part No.	375380	Ref. No.	6A049405
description	safety thermostat switch-off temp. 160°C 3-pole 20A probe ø 6mm probe L 89mm capillary pipe 900mm capillary pipe isolated 900mm gland nut probe SS		
For models:	74-02NPEI		

E-G-O



Part No.	375635	Ref. No.	6A046190
description	safety thermostat switch-off temp. 300°C 1-pole 20A probe ø 11mm probe L 16mm capillary pipe 900mm capillary pipe isolated 900mm gland nut screw-in probe probe thread M14x1		
For models:	NECVM10ES2, NECVM10GS2, NECVM20ES2, NECVM20GS2, NECV- M21ES2, NECVM21GS2, NECVM6ES2, NECVM6GS2, NECVP10ES2, NECVP10GS2, NECVP20ES2, NECVP20GS2, NECVP21ES2, NECVP21GS2, NECVP6ES2, NECVP6GS2		



1

Part No.	375228	Ref. No.	6A046150
description	safety thermostat switch-off temp. 350°C 3-pole 20A probe ø 3mm probe L 188mm capillary pipe 900mm capillary pipe isolated 900mm gland nut probe SS		
For models:	74-02CTEE, 74-02CTGE, 74-02VTCEV		

various
safety thermostats



1

Part No.	375637	Ref. No.	6A046185
description	safety thermostat switch-off temp. 135°C temperature range °C 1-pole 1NC 16A probe ø 6mm probe L 75mm capillary pipe 600mm capillary pipe isolatedmm gland nut shaft ømm probe copper 250V		
For models:	NECVP10ES2, NECVP10GS2, NECVP20ES2, NECVP20GS2, NECVP21ES2, NECVP21GS2, NECVP6ES2, NECVP6GS2		

accessories

probe clips

spring clips

for safety thermostat



1

Part No.	550981	Ref. No.	8208260
description	probe clip for pipe ø 8.5mm for probe ø 6mm for heating elements spacing 0.4mm Qty 1 pcs		
For models:	72-02FREM, 73-02FREM, 74-02FREM		

capillary tube clips



1

Part No.	550980	Ref. No.	8208270
description	capillary tube clip for pipe ø 8.5mm Qty 1 pcs		
For models:	72-02FREM, 73-02FREM, 74-02FREM		

connecting bows



1

Part No.	550060	Ref. No.	6A045900
description	connecting bow long for thermostat Qty 1 pcs		
For models:	74-02KBGB, 74-02KBGBI, 74-02KBGMB, 74-02KBGMBI, 76-02CTGGE		



1

Part No.	550059	Ref. No.	6A045000
description	connecting bow short for switch Qty 1 pcs		
For models:	74-02CTGE		

switches and momentary switches
push/momentary push switches

ø25mm



1

Part No.	345743	Ref. No.	2510607	
description	momentary push switch mounting ø 25mm red 1NO 250V 16A with cover cap ignition connection male faston 6.3mm ambient temperature max. 85°C protection IP65			
For models:	2FX+PCF			
accessories for	345743			
	Part No.	345039	Ref. No.	—
	protective cover round ED ø 33mm external size 23mm internal size 21mm H 12mm clear mounting ø 25mm			

2 hole fixing



1

Part No.	346359	Ref. No.	3108870
description	momentary push switch connection cable ambient temperature max. 85°C protection IP40 door contact switch		
For models:	NECVM10ES2, NECVM10GS2, NECVM20ES2, NECVM20GS2, NECVM21ES2, NECVM21GS2, NECVM6ES2, NECVM6GS2, NECVP10ES2, NECVP10GS2, NECVP20ES2, NECVP20GS2, NECVP21ES2, NECVP21GS2, NECVP6ES2, NECVP6GS2		



microswitches

pin-plunger actuated

M10



1

Part No.	345032	Ref. No.	6A039800
description	microswitch with plunger thread M10x1 thread L 12mm 250V 16A 1CO connection male faston 6.3mm stroke 7mm mounting distance 22mm L 28mm ambient temperature max. 125°C type SP9603 actuating force: 180g		
For models:	72-02FREM, 73-02FREM, 74-02FREM, 74-02KBGB, 74-02KBGBI, 74-02KBGMB, 74-02KBGMBI		

float switches



1



Part No.	401986	Ref. No.	6A021950
description	float switch thread 1/8" 1NO \varnothing 28mm L 116mm mounting \varnothing 10mm 220V 0.5A cable cable length 330mm		
For models:	74-02NPEI		

cam switches

on/off



1

Part No.	300020	Ref. No.	6A049300
description	cam switch 4 operating positions 2NO sequence 0-1-0-1 16A shaft \varnothing 6x4.6mm shaft L 23mm connection screw ceramic		
For models:	72-02FREM, 74-02FREM		
accessories for	300020		
	Part No.	110135	Ref. No. —
	rosette knob up to \varnothing 52mm		
	Part No.	110231	Ref. No. —
	knob switch 0-1-0-1 t.max.°C \varnothing 50mm shaft \varnothing 6x4.6mm shaft flat upper black		



1

Part No.	300021	Ref. No.	6A046700
description	cam switch 4 operating positions 4NO sequence 0-1-0-1 16A shaft \varnothing 6x4.6mm shaft L 23mm connection screw ceramic		
For models:	73-02FREM, 96-04CGFL, 96-04CGFL2P, 96-04CGFLP		

7-position



1

Part No.	300025	Ref. No.	6A045500
description	cam switch 7 operating positions 1NO/2CO sequence 0-1-2-3-4-5-6 16A shaft \varnothing 6x4.6mm shaft L 23mm connection screw 7-position ceramic		
For models:	92-04CE, 92-04TCE, 94-04CE, 94-04CEE, 94-04TCE		
accessories for	300025		



Part No.	112172	Ref. No.	—
-----------------	--------	-----------------	---

knob universal \varnothing 70mm black without adaptor/dial plate

Part No.	112213	Ref. No.	—
-----------------	--------	-----------------	---

knob dial plate silver switch 7-position t.max.°C ED \varnothing 63mm ID \varnothing 45.5mm

Part No.	112311	Ref. No.	—
-----------------	--------	-----------------	---

knob adapter shaft \varnothing 6x4.6mm L 0mm with spring

3 operating positions



1

Part No.	300167	Ref. No.	6A001412
description	cam switch 3 operating positions 2NO/1CO sequence 0-1-2 16A shaft \varnothing 6x4.6mm shaft L 23mm connection screw		
For models:	94-04PEI100L, 94-04PEI150L		



4 operating positions

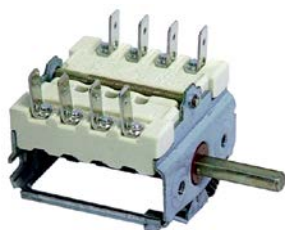

1

Part No.	300184	Ref. No.	6A046750
description	cam switch 4 operating positions sequence 0-3-2-1 shaft \varnothing 6x4.6mm connection male faston 4-pole		
For models:	74-02CTEE, 74-02CTGE, 74-02VTCEV, 94-04CEE, 94-04CGE, 94-04CGE1P, 94-04CGEP, 94-04CTEES, 94-04CTGE, 94-04VTCE, 96-04CGE, 96-04CGE2P, 96-04CGEE, 96-04CGEE2P, 96-04CGEEP, 96-04CGEP, 96-04CTGEDX, 96-04CTGESX, 98-04CGE, 98-04CGE2P, 98-04CGEP, 98-04CTGE		

operation switches



1

Part No.	300002	Ref. No.	6A046001
description	cam switch 2 operating positions 4NO 16A sequence 0-1 shaft \varnothing 6x4.6mm shaft L 23mm connection male faston 6.3mm ceramic		
For models:	74-02CTEE, 74-02CTGE, 74-02VTCEV, 94-04CEE, 94-04CTEES, 94-04CTGE, 94-04VTCE, 96-04CGEE, 96-04CGEE2P, 96-04CGEEP, 96-04CGGE, 96-04CGGE2P, 96-04CGGEP, 96-04CTGEDX, 96-04CTGESX, 98-04CTGE		



1

Part No.	300200	Ref. No.	6A046000
description	operation switch 2 operating positions 2NO 16A sequence 0-1 shaft \varnothing 6x4.6mm shaft L 23mm connection male faston 6.3mm operation switch ceramic		
For models:	74-02KBGB, 74-02KBGBI, 74-02KBGMB, 74-02KBGMBI, 76-02CTGGE		

magnetic switches

40x13mm

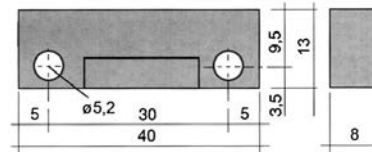

1

Part No.	346351	Ref. No.	6A047085
description	magnetic switch L 40mm W 13mm 1NO 250V 0.04A P max. 10W connection cable cable length 650mm		
For models:	NECVM10ES2, NECVM10GS2, NECVM20ES2, NECVM20GS2, NECVM21ES2, NECVM21GS2, NECVM6ES2, NECVM6GS2, NECVP10ES2, NECVP10GS2, NECVP20ES2, NECVP20GS2, NECVP21ES2, NECVP21GS2, NECVP6ES2, NECVP6GS2		

accessories

magnets

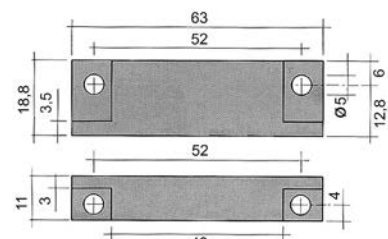

1

Part No.	345336	Ref. No.	3108890
description	magnet \varnothing 4.8mm L 63mm H 11mm W 18.8mm hole distance 51mm M4		
For models:	NECVM10ES2, NECVM10GS2, NECVM20ES2, NECVM20GS2, NECVM21ES2, NECVM21GS2, NECVM6ES2, NECVM6GS2, NECVP10ES2, NECVP10GS2, NECVP20ES2, NECVP20GS2, NECVP21ES2, NECVP21GS2, NECVP6ES2, NECVP6GS2		

miscellaneous



1

Part No.	346360	Ref. No.	3108879
description	switch mounting pos. door		
For models:	NECVM10ES2, NECVM10GS2, NECVM20ES2, NECVM20GS2, NECVM21ES2, NECVM21GS2, NECVM6ES2, NECVM6GS2, NECVP10ES2, NECVP10GS2, NECVP20ES2, NECVP20GS2, NECVP21ES2, NECVP21GS2, NECVP6ES2, NECVP6GS2		



control equipment

MOELLER/EATON

switch blocks



1

Part No.	346292	Ref. No.	50MAA78015
description	contact block screw 1NO		

encoders and potentiometers



1

Part No.	401194	Ref. No.	3103267
description	encoder		
For models:	NECVM10ES2, NECVM10GS2, NECVM20ES2, NECVM20GS2, NECVM21ES2, NECVM21GS2, NECVM6ES2, NECVM6GS2, NECVP10ES2, NECVP10GS2, NECVP20ES2, NECVP20GS2, NECVP21ES2, NECVP21GS2, NECVP6ES2, NECVP6GS2		



1

Part No.	300000	Ref. No.	3040.0268
description	potentiometer 5.2KOhm rotation 300° shaft ø6x4.6mm with switch shaft L 18mm thread M10x0.75		

lamps

indicator lights

indicator lights 2-piece (lens and indicator lamp)

indicator light lenses

ø12mm (type SDY-3)



1

Part No.	359262	Ref. No.	6A001438
description	indicator light housings mounting measurements ø12mm green round Qty 1 pcs		
For models:	94-04PEI100L, 94-04PEI150L		



1

Part No.	359261	Ref. No.	6A001436
description	indicator light housings mounting measurements ø12mm red round Qty 1 pcs		
For models:	94-04PEI100L, 94-04PEI150L		



1

Part No.	359260	Ref. No.	6A001437
description	indicator light housings mounting measurements ø12mm yellow round Qty 1 pcs		
For models:	94-04PEI100L, 94-04PEI150L		

indicator lamps for socket type SRZ / SDK / SDY / SFK



1

Part No.	359131	Ref. No.	6A038506
description	indicator lamp 400V clear connection male faston 6.3mm		
For models:	72-02FREM, 72-02TVTCV, 72-02VTCV, 73-02FREM, 74-02CTE, 74-02CTEE, 74-02CTGE, 74-02FREM, 74-02KBGB, 74-02KBGBI, 74-02KBGMB, 74-02KBGMBI, 74-02NPEI, 74-02TCTE, 74-02TVTCV, 74-02VTCEV, 74-02VTCV, 76-02CTGGE, 92-04TVTC, 92-04VTC, 94-04CEE, 94-04CGE, 94-04CGE1P, 94-04CGEP, 94-04CGG, 94-04CGG1P, 94-04CGGP, 94-04CTEES, 94-04CTES, 94-04CTGE, 94-04CTES, 94-04TVTC, 94-04VTC, 94-04VTCE, 96-04CGE, 96-04CGE2P, 96-04CGEE, 96-04CGEE2P, 96-04CGEEP, 96-04CGEP, 96-04CGFL, 96-04CGFL2P, 96-04CGFLP, 96-04CGG, 96-04CGG2P, 96-04CGGE, 96-04CGGE2P, 96-04CGGEP, 96-04CGEP, 96-04CTGEDX...(Other models you can see in the webshop)		



1

Part No.	359133	Ref. No.	6A001435
description	indicator lamp 400V green connection male faston 6.3mm		
For models:	94-04PEI100L, 94-04PEI150L		

indicator lights (complete)

ø12mm

with screw socket



1

Part No.	359994	Ref. No.	6A039207
description	indicator light ø 12mm 400V clear connection male faston 6.3mm		
For models:	72-02FREM, 73-02FREM, 74-02CTEE, 74-02CTGE, 74-02FREM, 74-02KBGB, 74-02KBGBI, 74-02KBGMB, 74-02KBGMBI, 74-02NPEI, 74-02VTCEV, 92-04CE, 92-04TCE, 94-04CE, 94-04CEE, 94-04CGE, 94-04CGE1P, 94-04CGEP, 94-04CTEES, 94-04CTES, 94-04CTGE, 94-04TCE, 94-04CTES, 94-04VTCE, 96-04CGE, 96-04CGE2P, 96-04CGEE, 96-04CGEE2P, 96-04CGEEP, 96-04CGEP, 96-04CGGE, 96-04CGGE2P, 96-04CGGEP, 96-04CTGEDX, 96-04CTGESX, 98-04CGE, 98-04CGE2P, 98-04CGEP, 98-04CTGE		



fluorescent lamps

accessories

ballasts



1

Part No.	401187	Ref. No.	6A047060
description	electrical ballast 60W for fluorescent lamps		
For models:	NECVM10ES2, NECVM10GS2, NECVM20ES2, NECVM20GS2, NECV-M6ES2, NECVM6GS2, NECVP10ES2, NECVP10GS2, NECVP20ES2, NECVP20GS2, NECVP6ES2, NECVP6GS2		

oven lamps

sockets

G4 / G5,3 / G6,35



1

Part No.	359836	Ref. No.	3108860
description	lamp socket socket G4 for halogen lamp		
For models:	NECVM10ES2, NECVM10GS2, NECVM20ES2, NECVM20GS2, NECV-M21ES2, NECVM21GS2, NECVM6ES2, NECVM6GS2, NECVP10ES2, NECVP10GS2, NECVP20ES2, NECVP20GS2, NECVP21ES2, NECVP21GS2, NECVP6ES2, NECVP6GS2		

residual heat indicators



1

Part No.	357003	Ref. No.	6A001404
description	residual heat indicator single 250V connection male faston 6.3mm mounting ø 14mm temp.-resist. 180°C		
For models:	72-02TVTCV, 72-02VTCV, 74-02TVTCV, 74-02VTCEV, 74-02VTCV, 92-04TVTC, 92-04VTC, 94-04TVTC, 94-04VTC, 94-04VTCE		

timers

programme timers





1

Part No.	360336	Ref. No.	3102335
description	timer FIBER P25 engines 1 chambers 1 operation time 30s 230V shaft ø 6x4.6mm shaft L 18mm manuf. no. P255J01C6R7 motor type M51BJ0R6400		
For models:	NECVM10ES2, NECVM10GS2, NECVM20ES2, NECVM20GS2, NECV-M21ES2, NECVM21GS2, NECVM6ES2, NECVM6GS2, NECVP10ES2, NECVP10GS2, NECVP20ES2, NECVP20GS2, NECVP21ES2, NECVP21GS2, NECVP6ES2, NECVP6GS2		
spare parts for	360336		
	Part No.	360673	Ref. No.
		motor kit pinion ø 6.8mm teeth 15 230V voltage AC 50/60Hz turn direction clockwise motor ø 48mm H 18.5mm motor type UDS-40NE1RNZ165 cable length 150mm with holder	

electric timers



1

Part No.	350015	Ref. No.	30130109
description	timer MS65 without bell operation time 120min time spreadmin 1CO/1NO at 250V 16A permanent position yes impulse electric shaft ø 6x4.6mm shaft L 23mm mounting distance 28mm connection lateral 2-pole		
accessories for	350015		
		Part No.	110366
		Ref. No.	—
		knob switch zero mark t.max.°C ø 44mm shaft ø 6x4.6mm shaft flat upper black	
		Part No.	111206
		Ref. No.	—
		dial plate graduation 120min permanent position no rotation 10-300° ø 60mm timers knob ø 45mm	

alarm devices

alarm units



1

Part No.	350114	Ref. No.	6A021955
description	buzzer 110-240VAC ø 22.5mm H 68mm built-in version mounting ø 22.5 80dB		
For models:	74-02NPEI		



buzzers



1

Part No.	350080	Ref. No.	3103266
description	buzzer buzzer		
For models:	NECVM10ES2, NECVM10GS2, NECVM20ES2, NECVM20GS2, NECVM21ES2, NECVM21GS2, NECVM6ES2, NECVM6GS2, NECVP10ES2, NECVP10GS2, NECVP20ES2, NECVP20GS2, NECVP21ES2, NECVP21GS2, NECVP6ES2, NECVP6GS2		



1

Part No.	380337	Ref. No.	6A047037
description	power contactor resistive load 20A 230VAC (AC3/400V) 8.4A/4kW main contacts 4NO auxiliary contacts connection screw connection type AEG LS05 400A type GE MC1A 400A		
For models:	NECVM10ES2, NECVM10GS2, NECVM20ES2, NECVM20GS2, NECVM21ES2, NECVM21GS2, NECVM6ES2, NECVM6GS2, NECVP10ES2, NECVP10GS2, NECVP20ES2, NECVP20GS2, NECVP21ES2, NECVP21GS2, NECVP6ES2, NECVP6GS2		

contactors

ABB

power contactors



1

Part No.	380104	Ref. No.	6A001410
description	power contactor resistive load 25A 230VAC (AC3/400V) 9A/4kW main contacts 3NO auxiliary contacts 1NO connection screw connection type A9-30-10		
For models:	94-04PEI100L, 94-04PEI150L		



1

Part No.	380245	Ref. No.	6A047034
description	power contactor resistive load 25A 230VAC (AC3/400V) 9A/4kW main contacts 3NO auxiliary contacts 1NC connection screw connection type AEG LS4K 01A type GE CL00A 301 H 85mm		
For models:	72-02FREM, 74-02FREM, 74-02NPEI, CVP6E, NECVM10ES2, NECVM6ES2, NECVP10ES2, NECVP10GS2, NECVP20ES2, NECVP20GS2, NECVP21ES2, NECVP21GS2, NECVP6ES2		

GENERAL ELECTRIC (AEG)

power contactors



1

Part No.	380239	Ref. No.	6A047031
description	power contactor resistive load 20A 230VAC (AC3/400V) 8.4A/4kW main contacts 3NO auxiliary contacts 1NC connection screw connection type LS05 01A type AEG LS05 01A type GE MC1A 301A		
For models:	73-02FREM, 94-04CEE, 94-04CTEES, 94-04CTGE, 96-04CGEE, 96-04CGEE2P, 96-04CGEEP, 96-04CGGE, 96-04CGGE2P, 96-04CGGEP, 96-04CTGEDX, 96-04CTGESX, 98-04CTGE, NECVM6ES2, NECVP6ES2, NECVP6GS2		



1

Part No.	380262	Ref. No.	6A047036
description	power contactor resistive load 32A 230VAC (AC3/400V) 17A/7.5kW main contacts 3NO auxiliary contacts 1NC connection screw connection type AEG LS7K01A type GE CL02A 301 H 85mm		
For models:	72-02VTVCV, 72-02VTVCV, 74-02VTVCV, 74-02VTCEV, 74-02VTVCV, 92-04TVTC, 92-04VTC, NECVM20ES2, NECVP20ES2		



1

Part No.	380385	Ref. No.	6A047035
description	power contactor resistive load 60A 230VAC (AC3/400V) 32A/16kW main contacts 3NO auxiliary contacts 1NC connection screw connection type AEG LS15K 01A type GE CL04A 310		
For models:	NECVM20ES2, NECVM21ES2, NECVP20ES2, NECVP21ES2		

auxiliary contacts



1

Part No.	380242	Ref. No.	6A047038
description	auxiliary contact contacts 1NO/1NC for contactors M+LS05 connection screw AC-12 10A type AEG HS05K 11HS type GE MARN 211		
For models:	CVP6E, NECVM10ES2, NECVM10GS2, NECVM20ES2, NECVM-20GS2, NECVM21ES2, NECVM21GS2, NECVM6ES2, NECVM-6GS2, NECVP10ES2, NECVP10GS2, NECVP20ES2, NECVP20GS2, NECVP21ES2, NECVP21GS2, NECVP6ES2, NECVP6GS2		

MOELLER/EATON

RC circuits



1

Part No.	380179	Ref. No.	3035.0514
description	RC circuit		



1

Part No.	380177	Ref. No.	1003379 3035.0508
description	RC circuit type 20002 110/220V 50/60/DChz conductor 2 connection cable 230mm L 29mm ømm H 15mm W 20mm adhesive tape plastic Qty 1 pcs		

relays



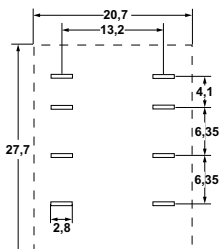

power relays

with male contacts

female contact 2.0mm

1

Part No.	380377	Ref. No.	6A047070	
description	power relays FINDER 220-240VAC 10A 2CO connection F2 plug-in connection manuf. no. 55.32.8.230.0000 94.92.3 250V			
For models:	74-02NPEI			
accessories for	380377			
	Part No.	380341	Ref. No.	—
		relay socket 4-pole contacts 12 300V voltage AC 6A Italiana Relè manuf. no. ZMD4		
	Part No.	380378	Ref. No.	—
		relay socket 2-pole 55/85 dimensions 70.5x30x27mm 250V voltage AC 10A FINDER manuf. no. 94.72		
	Part No.	380384	Ref. No.	6A047074 A047074
		relay socket 2-pole contacts male faston 2.8mm 250V voltage AC 10A W 23mm for		
	Part No.	380399	Ref. No.	—
		relay socket 4-pole dimensions 76.2x27x86.1mm 250V voltage AC 1A FINDER manuf. no. 94.94.3		

plug-in/print relays



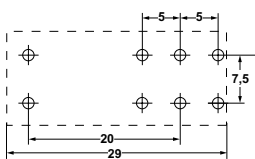



1

Part No.	381151	Ref. No.	3006078
description	print relay 24VAC 2CO 2-pole at 250V 8A connection pins raster size 5mm FINDER manuf. no. 40.52.8.024.0000 95.65/95.75		

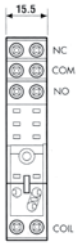

relay sockets

 			
1			
Part No.	381181	Ref. No.	3006079
description	relay socket 2-pole 40.51/40.52/40.61 connection screw clamp dimensions 15.8x78.6mm 250V voltage AC 10A FINDER manuf. no. 95.75		
accessories for	381181		
	Part No.	381455	Ref. No. —
	support bracket		

			
1			
Part No.	380384	Ref. No.	6A047074
description	relay socket 2-pole contacts male faston 2.8mm 250V voltage AC 10A W 23mm for		
For models:	74-02NPEI, CVP10E, CVP6E		
accessories for	380384		
	Part No.	380804	Ref. No. —
	support bracket		

level relays

GICAR

			
1			
Part No.	401224	Ref. No.	6A001423
description	level relay 230V connection F6.3 type RL30/3ES/F/G		
For models:	94-04PEI100L, 94-04PEI150L		

transformers

open transformers

with clamp terminal

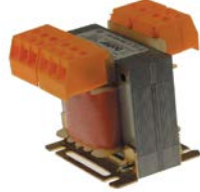
			
1			
Part No.	401189	Ref. No.	6A047047
description	transformer 20VA		
For models:	NECVM10ES2, NECVM10GS2, NECVM20ES2, NECVM20GS2, NECVM21ES2, NECVM21GS2, NECVM6ES2, NECVM6GS2, NECVP10ES2, NECVP10GS2, NECVP20ES2, NECVP20GS2, NECVP21ES2, NECVP21GS2, NECVP6ES2, NECVP6GS2		

for lighting

			
1			
Part No.	401188	Ref. No.	6A047061
description	transformer primary 240V secondary 11.5V 100VA		
For models:	NECVM21ES2, NECVM21GS2, NECVP21ES2, NECVP21GS2		

probes

producer-specific probes

			
1			
Part No.	379936	Ref. No.	3103275
description	temperature probe Pt100 cable Vetrotex probe -200 up to +600°C cable -50 up to +350°C connection 2-wire thread probe Ø4-6x100mm cable length 1m		
For models:	NECVM10ES2, NECVM10GS2, NECVM20ES2, NECVM20GS2, NECVM21ES2, NECVM21GS2, NECVM6ES2, NECVM6GS2, NECVP10ES2, NECVP10GS2, NECVP20ES2, NECVP20GS2, NECVP21ES2, NECVP21GS2, NECVP6ES2, NECVP6GS2		

			
1			
Part No.	379937	Ref. No.	3103282
description	temperature probe thermocouple K (NiCr-Ni) cable PTFE probe -50 up to 1150°C cable -40 up to +250°C connection 2-wire thread probe Ø4x120mm cable length 2.4m -40 up to +250°C		
For models:	NECVM10ES2, NECVM10GS2, NECVM20ES2, NECVM20GS2, NECVM21ES2, NECVM21GS2, NECVM6ES2, NECVM6GS2, NECVP10ES2, NECVP10GS2, NECVP20ES2, NECVP20GS2, NECVP21ES2, NECVP21GS2, NECVP6ES2, NECVP6GS2		



core probes



Part No.	379939	Ref. No.	3103280
description	core temperature probe Pt100 cable PTFE probe -40 up to +250°C cable -40 up to +250°C connection plug probe ø4x100mm thread cable length 1.25m handle ø 10mm handle length 90/100mm		
For models:	NECVM10ES2, NECVM10GS2, NECVM20ES2, NECVM20GS2, NECVM21ES2, NECVM21GS2, NECVM6ES2, NECVM6GS2, NECVP10ES2, NECVP10GS2, NECVP20ES2, NECVP20GS2, NECVP21ES2, NECVP21GS2, NECVP6ES2, NECVP6GS2		
accessories for	379939		
	Part No.	379938	Ref. No. 3103285
	female connector 4-pole		

accessories

plugs/bushes

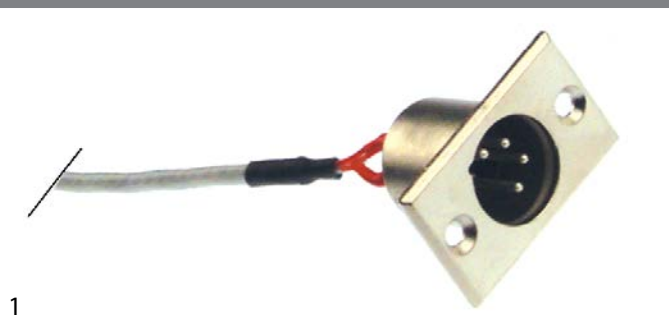

Part No.	379938	Ref. No.	3103285
description	female connector 4-pole		
For models:	NECVM10ES2, NECVM10GS2, NECVM20ES2, NECVM20GS2, NECVM21ES2, NECVM21GS2, NECVM6ES2, NECVM6GS2, NECVP10ES2, NECVP10GS2, NECVP20ES2, NECVP20GS2, NECVP21ES2, NECVP21GS2, NECVP6ES2, NECVP6GS2		

	Part No.	379940	Ref. No. 3103290
description	lid		
For models:	NECVM10ES2, NECVM10GS2, NECVM20ES2, NECVM20GS2, NECVM21ES2, NECVM21GS2, NECVM6ES2, NECVM6GS2, NECVP10ES2, NECVP10GS2, NECVP20ES2, NECVP20GS2, NECVP21ES2, NECVP21GS2, NECVP6ES2, NECVP6GS2		

electronics

PCBs

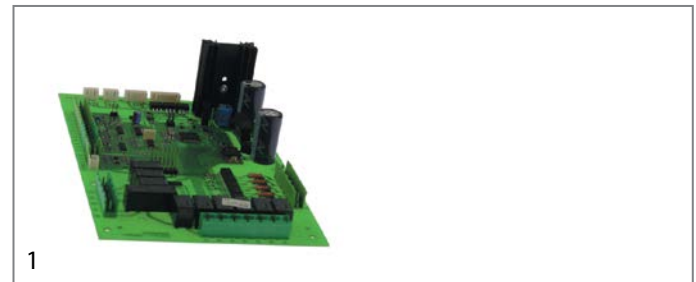

Part No.	401192	Ref. No.	3103249
description	main PCB		
For models:	NECVM10ES2, NECVM10GS2, NECVM20ES2, NECVM20GS2, NECVM21ES2, NECVM21GS2, NECVM6ES2, NECVM6GS2, NECVP10ES2, NECVP10GS2, NECVP20ES2, NECVP20GS2, NECVP21ES2, NECVP21GS2, NECVP6ES2, NECVP6GS2		

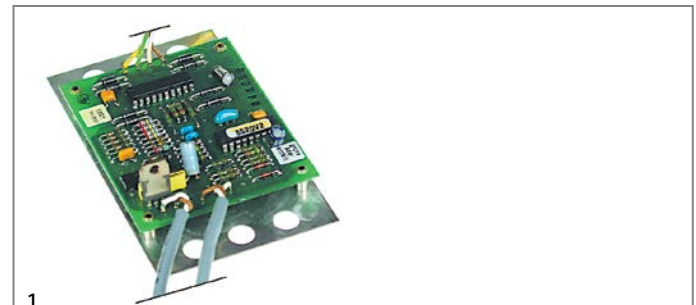

Part No.	401479	Ref. No.	3040.2602 8720.1293
description	PCB combi-steamer		

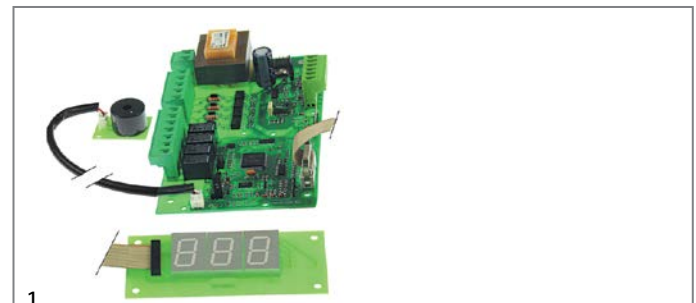

Part No.	401195	Ref. No.	3198400
description	PCB combi-steamer CV10E complete without potentiometer		
For models:	CVP10E, CVP6E		



Part No.	403230	Ref. No.	50603
description	PCB dishwasher 125EU L 190mm W 110mm with housing H 70mm		

→ electric components



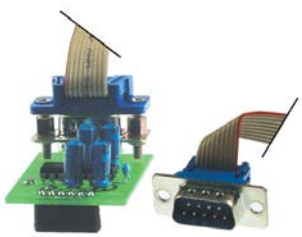

			
1			
Part No.	401193	Ref. No.	3103246
description	PCB HACCP interface		
For models:	NECVM10ES2, NECVM10GS2, NECVM20ES2, NECVM20GS2, NECVM21ES2, NECVM21GS2, NECVM6ES2, NECVM6GS2, NECVP10ES2, NECVP10GS2, NECVP20ES2, NECVP20GS2, NECVP21ES2, NECVP21GS2, NECVP6ES2, NECVP6GS2		

keypads

front foils

			
1			
Part No.	403289	Ref. No.	96704
description	keypad foil dishwasher LP25/LP35/LP48/GR800/TwinStar blue L 200mm W 135mm buttons 6		

keypad units

			
1			
Part No.	402678	Ref. No.	50570
description	keypad unit dishwasher H63/373E/144E buttons 6 L 158mm W 103mm		
accessories for	402678		
	Part No.	402685	Ref. No. —
	keypad foil dishwasher H63/373E/144E L 134mm W 79mm buttons 6		

solenoid valves

solenoid valves (water)

ROBERTSHAW/INVENSYS

medium temperature: 90°C 90°C 60°C
 ambient temperature: 60°C 25°C 60°C
 duty cycle: 40% 100% 100%

			
1			
Part No.	370371	Ref. No.	3002.0304
description	solenoid valve double straight 230VAC inlet 3/4" outlet 11.5mm DN10 EATON (INVENSYS) cable length 2000mm		

RPE

			
1			
Part No.	374021	Ref. No.	3103610
description	solenoid valve double straight 230VAC inlet 3/4" outlet 10mm DN10 RPE		
For models:	NECVP10ES2, NECVP10GS2, NECVP20ES2, NECVP20GS2, NECVP21ES2, NECVP21GS2, NECVP6ES2, NECVP6GS2		

			
1			
Part No.	374017	Ref. No.	3103620
description	solenoid valve single straight 230VAC inlet 3/4" outlet 10mm input 6l/min DN10 RPE polyamide flow regulating valve inlet white membranes NBR pressure range 0.2-10bar		
For models:	NECVM10ES2, NECVM10GS2, NECVM20ES2, NECVM20GS2, NECVM21ES2, NECVM21GS2, NECVM6ES2, NECVM6GS2		

			
1			
Part No.	374060	Ref. No.	2000093
description	solenoid valve single angled 24V inlet 3/4" outlet 13mm DN10 duty cycle 100% RPE polyamide		



TP			
spare parts and accessories			
reducers			
inlet side			
1			
Part No.	371209	Ref. No.	3103643
description	reducer red ø 1.7mm mounting measurements 19.5mm		
For models:	NECVP10ES2, NECVP10GS2, NECVP20ES2, NECVP20GS2, NECVP21ES2, NECVP21GS2, NECVP6ES2, NECVP6GS2		

	1		
Part No.	541350	Ref. No.	6A022200
description	pressure control pressure range adjustable 0.3-0.8bar connection 1/4" CO 250V 10A ambient temperature max. 60°C pressure connection 1/4"		
For models:	74-02NPEI		

ball valves electric

	1		
Part No.	401190	Ref. No.	3103590
description	ball valve inlet 3/4" IT outlet 3/4" IT IP42 230V L 68mm 50/60Hz closed off-current mode of operation electric connection cable 300mm 3.5W duty cycle 50%		
For models:	NECVP10ES2, NECVP10GS2, NECVP20ES2, NECVP20GS2, NECVP21ES2, NECVP21GS2, NECVP6ES2, NECVP6GS2		

electrodes

	1		
Part No.	401208	Ref. No.	6A037482
description	level electrode 1/4" total length 150mm probe L 124mm insulated probe length 69mm PTFE insulated connection male faston 6.3mm stainless steel ø 2.5mm		
For models:	NECVM10ES2, NECVM10GS2, NECVM20ES2, NECVM20GS2, NECVM21ES2, NECVM21GS2, NECVM6ES2, NECVM6GS2, NECVP10ES2, NECVP10GS2, NECVP20ES2, NECVP20GS2, NECVP21ES2, NECVP21GS2, NECVP6ES2, NECVP6GS2		

pressure switches

for gas equipment

	1		
Part No.	541111	Ref. No.	30171010
description	pressure control pressure range adjustable 0.2- 3mbar pressure connection horizontal gas technology connection 6mm suitable for RATIONAL		

	1		
Part No.	401209	Ref. No.	6A037481
description	level electrode 1/4" total length 180mm probe L 155mm insulated probe length 70mm PTFE insulated connection male faston 6.3mm stainless steel ø 2.5mm		
For models:	NECVM10ES2, NECVM10GS2, NECVM20ES2, NECVM20GS2, NECVM21ES2, NECVM21GS2, NECVM6ES2, NECVM6GS2, NECVP10ES2, NECVP10GS2, NECVP20ES2, NECVP20GS2, NECVP21ES2, NECVP21GS2, NECVP6ES2, NECVP6GS2		

for steam control

	1		
Part No.	541074	Ref. No.	3103630
description	pressure control ø 45mm triggering pressure 0.5bar reset pressure 0.35bar pressure connection vertical steam control pressure range 0.35/0.51bar connection 1/8" pressure connection 1/8"		
For models:	NECVM10ES2, NECVM10GS2, NECVM20ES2, NECVM20GS2, NECVM21ES2, NECVM21GS2, NECVM6ES2, NECVM6GS2		



fans

axial fans

ebm-papst



Part No.	601030 ¹	Ref. No.	3102350
description	axial fan L 119mm W 119mm H 38mm 230VAC 50Hz 18W bearing ball bearing manuf. no. 4656Z metal connection male faston 2.8mm ebm-papst fan wheel ø 110mm temp.-resist. 75°C		
For models:	NECVM10ES2, NECVM10GS2, NECVM20ES2, NECVM20GS2, NECVM21ES2, NECVM21GS2, NECVM6ES2, NECVM6GS2, NECVP10ES2, NECVP10GS2, NECVP20ES2, NECVP20GS2, NECVP21ES2, NECVP21GS2, NECVP6ES2, NECVP6GS2		
accessories for	601030		
	Part No.	550898	Ref. No. —
	connecting cable cable length 2000mm connection F 2.8 connection distance 7.9mm for axial flow fan		
	Part No.	692497	Ref. No. —
	guard ø 105mm mounting distance 150mm for axial fan ebm-papst-mm		

¹with ball bearings

import



Part No.	601055 ¹	Ref. No.	6A036420
description	axial fan L 92mm W 92mm H 25mm 230VAC 50/60Hz 14.5/14W bearing ball bearing connection male faston 2.8mm metal ADDA fan wheel ø 85mm temp.-resist. 70°C		
For models:	72-02TVTCV, 72-02VTCV, 74-02TVTCV, 74-02VTCEV, 74-02VTCV, 92-04TVTC, 92-04VTC, 94-04TVTC, 94-04VTC, 94-04VTCE		
accessories for	601055		
	Part No.	550898	Ref. No. —
	connecting cable cable length 2000mm connection F 2.8 connection distance 7.9mm for axial flow fan		
	Part No.	691103	Ref. No. —
	guard ø 90mm mounting distance 83mm for axial fan 92mm		

¹with ball bearings

hot air motors

Part No.	500647	Ref. No.	3102210
description	fan motor 230V 1 phase 50Hz 0.13/0.55kW 700/1400rpm speeds 2 L1 188mm L2 64mm L3 46mm D1 ø 24mm D2 ø 20mm 0.66/2.4A suitable capacitor 25µF Cos(φ) 0.98 at 50Hz 700/1400rpm at 60Hz 850/1700rpm 4P/8P type LM/FB80 no. 483823		
For models:	CVP10E, CVP6E		

Part No.	500649	Ref. No.	3102212
description	fan motor 230V 1 phase 50Hz 0.13/0.55kW 700/1400rpm speeds 2 L1 200mm L2 67mm L3 47mm D1 ø 24mm D2 ø 20mm M12L IT 0.66/2.4A suitable capacitor 8/25 µF Cos(φ) 0.98 at 50Hz 700/1400rpm at 60Hz 850/1700rpm 4P/8P type LM/FB80 no. 635521		
For models:	NECVM10ES2, NECVM10GS2, NECVM20ES2, NECVM20GS2, NECVM21ES2, NECVM21GS2, NECVM6ES2, NECVM6GS2, NECVP10ES2, NECVP20ES2, NECVP21ES2, NECVP6ES2		

Part No.	500648	Ref. No.	3102312
description	fan motor 400V 3 phase 50Hz 0.13/0.55kW 720/1440rpm speeds 2 L1 198mm L2 65mm L3 47mm D1 ø 24mm D2 ø 20mm M12L IT 400 0.4/0.85A Cos(φ) 0.60/0.75 at 50Hz 720/1440rpm at 60Hz 860/1720rpm type FB80 4/8 no. 500256		
For models:	NECVM10ES2, NECVM20ES2, NECVM21ES2, NECVM6ES2, NECVP10ES2, NECVP10GS2, NECVP20ES2, NECVP20GS2, NECVP21ES2, NECVP21GS2, NECVP6ES2, NECVP6GS2		





1

Part No.	601214	Ref. No.	3101630
description	fan wheel D1 ø 335mm H1 135mm blades 12 D2 ø 19.5mm D3 ø 23.5mm H2 51mm		
For models:	NECVM20ES2, NECVM20GS2, NECVP20ES2, NECVP20GS2		
accessories for	601214		
	Part No.	560449	Ref. No. —
	hexagonal screw thread M12x1.5 L thread L 22mm bore ø 6.3mm WS 19 total length 30mm		



1

Part No.	601213	Ref. No.	3101600
description	fan wheel D1 ø 335mm H1 135mm blades 16 D2 ø 19.5mm D3 ø 23.5mm H2 50.5mm		
For models:	NECVM10ES2, NECVM10GS2, NECVM21ES2, NECVM21GS2, NECVM6ES2, NECVM6GS2, NECVP10ES2, NECVP10GS2, NECVP21ES2, NECVP21GS2, NECVP6ES2, NECVP6GS2		



1

Part No.	550850	Ref. No.	3102500
description	flange pair for fan motor ED ø 70mm int. ø 1 43.5mm int. ø 2 24.5mm thickness 5mm brass		
For models:	NECVM10ES2, NECVM10GS2, NECVM20ES2, NECVM20GS2, NECVM21ES2, NECVM21GS2, NECVM6ES2, NECVM6GS2, NECVP10ES2, NECVP10GS2, NECVP20ES2, NECVP20GS2, NECVP21ES2, NECVP21GS2, NECVP6ES2, NECVP6GS2		



1

Part No.	550849	Ref. No.	3102400
description	gasket for fan motor ID ø 24mm ED ø 36mm thickness 4.5mm		
For models:	NECVM10ES2, NECVM10GS2, NECVM20ES2, NECVM20GS2, NECVM21ES2, NECVM21GS2, NECVM6ES2, NECVM6GS2, NECVP10ES2, NECVP10GS2, NECVP20ES2, NECVP20GS2, NECVP21ES2, NECVP21GS2, NECVP6ES2, NECVP6GS2		

motors

gear motors

for ovens

for flues



1

Part No.	361999	Ref. No.	3101.1010 3101.1010S
description	gear motor CROUZET type 82841042 12V voltage DC shaft ø 4mm L 65mm W 50mm H 51mm for oven		

motors

for combi-steamers



1

Part No.	401480	Ref. No.	86801006
description	motor for humidity measuring		

universal



1

Part No.	601463	Ref. No.	2510631
description	motor 90W 230V 50Hz 1 phase shaft ø 9mm flange ø 80mm 1300rpm type AMM56ZAA4 ø 110mm H 150mm L 170mm Lafert 0.09kW		
For models:	74-02KBGMB, 74-02KBGMBI		



pumps



wash and rinse pumps

FIR

pumps



1

Part No.	500058	Ref. No.	8052550
description	pump inlet ø 63mm outlet ø 53mm type 2241.2500 230/400V 50Hz 3 phase 0.89kW 1.2HP L 305mm rotation direction left FIR		
spare parts for	500058		
	Part No.	510531	Ref. No. —
	pump cover FIR inlet ø 63mm outlet ø 53mm auxiliary pressure connection M16x1.5mm supporting pressure open turn direction left ø 185mm ID ø 150mm inner height 37mm		
	Part No.	510693	Ref. No. —
	mechanical shaft seal for shaft ø 12mm slide ring ext. ø 24mm slide ring H 15.5mm slide ring int. ø 11mm counter ring mounting ø 24mm height counter ring 8mm counter ring int. ø 13.5mm		
	Part No.	510834	Ref. No. —
	impellor ø 110mm H 29mm thread M8R suitable for FIR		
	Part No.	524416	Ref. No. —
	pump cover gasket thickness 4x4mm Qty 1 pcs		
accessories for	500058		
	Part No.	504329	Ref. No. —
	blind plug H 17.5mm thread M16x1.5 plastic WS 22 for pump		
	Part No.	524046	Ref. No. —
	vibration damper L 40mm W 25mm H 25mm for pump		

LOWARA

pumps



1

Part No.	499255	Ref. No.	5210877
description	pump inlet ø 1 1/4" IT outlet ø 1" IT type CEAM/70/3/A 220-240V 50Hz 1 phase 0.6kW L 310mm rotation direction left capacitor 14µF LOWARA		

OLYMPIA

pumps



1





Part No.	499318	Ref. No.	1051/A
description	pump inlet ø 28mm outlet ø 28mm type L63.T19 230V 50Hz 1 phase 0.19kW L 185mm rotation direction right capacitor 5µF OLYMPIA inlet ø 28mm outlet ø 28mm		
spare parts for	499318		
	Part No.	365017	Ref. No. —
	operating capacitor capacity 5µF 450V tolerance 5% 50/60Hz ambient temperature max. -25 to +85°C ø 28mm L 54mm M8 plastic connection male faston 6.3mm 16.10.08 protection		
	Part No.	510693	Ref. No. —
	mechanical shaft seal for shaft ø 12mm slide ring ext. ø 24mm slide ring H 15.5mm slide ring int. ø 11mm counter ring mounting ø 24mm height counter ring 8mm counter ring int. ø 13.5mm		
	Part No.	521163	Ref. No. —
	pump cover OLYMPIA inlet ø 28mm outlet ø 26mm pump type L63.T19		
	Part No.	521164	Ref. No. —
	impellor ø 64mm H 15mm pump type L63.T19 thread M7L shaft ø 12mm shaft length 30mm		

Table continues overleaf



spare parts for	499318			
	Part No.	521724	Ref. No.	—
	O-ring EPDM thickness 1.78mm ID ø 72.75mm Qty 1 pcs			

drain pumps

HANNING



Part No.	500573	Ref. No.	4400207
description	drain pump 30W 4-piece 230V inlet ø 24/30mm outlet ø 24mm 50Hz HANNING type DPS25-032 1x pump, 3x pump cover		

service kits



Part No.	500573	Ref. No.	4400207
description	drain pump 30W 4-piece 230V inlet ø 24/30mm outlet ø 24mm 50Hz HANNING type DPS25-032 1x pump, 3x pump cover		

vibration pumps



Part No.	500580	Ref. No.	87201526
description	vibration pump 230V 60W 50/60Hz inlet ø 7 outlet ø 1/8" IT CEME type E512 with accessories duty cycle 1/2 ambient temperature max. 60°C medium temp max. 35°C overheating protection 110°C CleanJet		

condensators & interference suppression filters

filters

RC circuits



1	Part No.	380179	Ref. No.	3035.0514
	description	RC circuit		



1	Part No.	380177	Ref. No.	1003379 3035.0508
	description	RC circuit type 20002 110/220V 50/60/DChz conductor 2 connection cable 230mm L 29mm ømm H 15mm W 20mm adhesive tape plastic Qty 1 pcs		

fuses

fine fuses

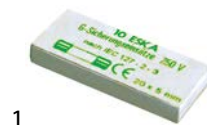

1	Part No.	358605	Ref. No.	6A001420
	description	fine fuse size ø5x20mm 3.15A slow-acting rated 250V Qty 10 pcs		
	For models:	94-04PEI100L, 94-04PEI150L		

fine fuse holders



1	Part No.	550848	Ref. No.	6A034500
	description	fuse holder suitable fuse ø5x20mm		
	For models:	NECVM10ES2, NECVM10GS2, NECVM20ES2, NECVM20GS2, NECVM21ES2, NECVM21GS2, NECVM6ES2, NECVM6GS2, NECVP10ES2, NECVP10GS2, NECVP20ES2, NECVP20GS2, NECVP21ES2, NECVP21GS2, NECVP6ES2, NECVP6GS2		



screw locks

gauge pieces (NEOZED)



1

Part No.	358066	Ref. No.	4001.1239
description	gauge piece size D02 suitable for 25A		



1

Part No.	358068	Ref. No.	4001.1241
description	gauge piece size D02 suitable for 50A		

electric accessories

cables

accessories

cable glands

cable glands



1

Part No.	550311	Ref. No.	8217570
description	cable gland ID ø 6mm mounting ø 9mm ED ø 14mm Neoprene -30 up to +90°C Qty 10 pcs		
For models:	72-02FREM, 73-02FREM, 74-02FREM		

terminals

connection terminals with screw/faston connections



1

Part No.	550349	Ref. No.	6A036204
description	power terminal block 4-pole max. 40A max 400V connection ø6mm² / F6.3 temp.-resist. 150°C cross section 6mm²		
For models:	74-02K BGB, 74-02K BGBI, 74-02K BGBM, 74-02K BGBMI		



1

Part No.	550977 ¹	Ref. No.	6A036206
description	power terminal block 6-pole max. 40A max 450V connection ø6mm² / F6.3 temp.-resist. 150°C cross section 6mm² with ground lug		
For models:	74-02CTGE, 92-04CE, 92-04TCE, 94-04CE, 94-04CEE, 94-04TCE		

¹with ground lug

gas taps

PEL

21S series



1

Part No.	103329	Ref. No.	6A011490
description	gas tap PEL type 21S gas inlet M16x1.5 (tube ø 10mm) bypass nozzle ø 0.35mm gas outlet M16x1.5 (tube ø 10/8mm) thermocouple connection M8x1 pilot connection M10x1 shaft ø 8x6.5mm shaft L 22/15mm shaft flat upper		
For models:	2FX+PCF, 4FX+PCF, 74-02+2CTGG, 74-02CTG, 74-02CTGE, 74-02CTGG, 74-02TCTG, 76-02+4CTGG, 76-02CTG, 76-02CTGG, 76-02CTGGE, 76-02TCTGG, 92-04CG, 92-04CG1P, 92-04CGP, 92-04PLG, 92-04TCG, 92-04TCG1P, 92-04TCGP, 92-04TPLG, 94-04CG, 94-04CG1P, 94-04CGE, 94-04CGE1P, 94-04CGEP, 94-04CGG, 94-04CGG1P, 94-04CGGP, 94-04CGPP, 94-04CTGGSS, 94-04CTGSS, 94-04PLG, 94-04TCG, 94-04TCG1P, 94-04TCGP, 94-04TCTGSS, 94-04TPLG, 96-04CG, 96-04CG2P, 96-04CGE, 96-04CGE2P, 96-04CGEE, 96-04CGEE2P, 96-04CGEEP, 96-04CGEP, 96-04CGFL, 96-04CGFL2P, 96-04CGFLP, 96-04CGG, 96-04CGG2P... (Other models you can see in the webshop)		

22S/O series

















1

Part No.	101086	Ref. No.	6A011500	
description	gas tap PEL type 22S/O gas inlet M20x1.5 (tube ø 12mm) bypass nozzle ø 0.35mm gas outlet M20x1.5 (tube ø 12/10mm) thermocouple connection M9x1 pilot connection M10x1 shaft ø 10x8mm shaft L 25/17mm shaft flat lower			
For models:	2FX+PCF, 4FX+PCF, 74-02+2CTGG, 74-02CTG, 74-02CTGE, 74-02CTGG, 74-02TCTG, 76-02+4CTGG, 76-02CTG, 76-02CTGG, 76-02CTGGE, 76-02TCTGG, 94-04CTGGSS, 94-04CTGSS, 94-04TCTGSS, 96-04CTGDX, 96-04CTGEDX, 96-04CTGESX, 96-04CTGGDX, 96-04CTGGSX, 96-04CTGSX, 96-04TCTGDX, 96-04TCTGSX, 98-04CTG, 98-04CTGE, 98-04CTGG, 98-04TCTG			
spare parts for	101086			
	Part No.	100259	Ref. No.	—
	Part No.	101058	Ref. No.	—
	Part No.	101201	Ref. No.	—

Table continues overleaf



spare parts for		101086		
	Part No.	101231	Ref. No.	—
	thermocouple nut T1: M9x1 T2: M18x1			
	Part No.	101240	Ref. No.	—
	gas connection thread M20x1.5 tube ø 12/10mm for PEL gas taps with gasket and screws horizontal			
	Part No.	101460	Ref. No.	—
	O-ring ø 12.37mm D1 ø 2.62mm suitable for PEL22			
	Part No.	101461	Ref. No.	—
	screw kit suitable for PEL22 Qty 4 pcs			
accessories for		101086		
	Part No.	100908	Ref. No.	6A016110 6A017000
	union screw thread M10x1 for pipe ø 4mm Qty 1 pcs			
	Part No.	100909	Ref. No.	—
	union screw thread M10x1 for pipe ø 6mm Qty 1 pcs			
	Part No.	101241	Ref. No.	—
	gas connection thread M20x1.5 tube ø 12/10mm for PEL gas taps vertical			
	Part No.	101246	Ref. No.	6A016120
	olive for pipe ø 4mm Qty 1 pcs			
	Part No.	101248	Ref. No.	—
	olive for pipe ø 12mm Qty 1 pcs suitable for PEL			
	Part No.	101249	Ref. No.	6A011470
	olive for pipe ø 10mm Qty 1 pcs			
	Part No.	101250	Ref. No.	6A011475
	union nut thread M20x1.5 for pipe ø 10mm			
	Part No.	101251	Ref. No.	6A016200
	union nut thread M20x1.5 for pipe ø 12mm			
	Part No.	101286	Ref. No.	—
	olive ID ø 6mm Qty 1 pcs			
	Part No.	110080	Ref. No.	—
	knob ø 70mm shaft ø 10x8mm shaft flat universal			
	Part No.	112206	Ref. No.	—
	knob dial plate silver gas tap PEL21/22/23 t.max.°C ED ø 63mm ID ø 45.5mm			

23S/O series



1

Part No.	101092	Ref. No.	6A013600	
description	gas tap PEL type 23S/O gas inlet M28x1.5 (tube ø 20mm) bypass nozzle ø 0.35mm gas outlet M24x1.5 (tube ø 16mm) thermocouple connection M10x1 pilot connection M10x1 shaft ø 10x8mm shaft L 25/17mm shaft flat upper			
For models:	92-04PLG, 92-04TPLG, 94-04PLG, 94-04TPLG, 96-04CTGDX, 96-04CTGEDX, 96-04CTGESX, 96-04CTGGDX, 96-04CTGGSX, 96-04CTGSX, 96-04TCTGDX, 96-04TCTGSX, 98-04CTG, 98-04CTGE, 98-04CTGG, 98-04TCTG			
spare parts for		101092		
	Part No.	100455	Ref. No.	—
	bypass nozzle type PEL23/24 bore ø 0.35mm thread M8x0.5			
	Part No.	101059	Ref. No.	—
	magnet unit T1: M10x1 T2: M22x1 L 46mm ø 18mm suitable for PEL23S M10x1			
	Part No.	101204	Ref. No.	—
	gas tap front part shaft ø 10x8mm shaft L 25/17mm shaft flat upper/lower suitable for PEL23S			
	Part No.	101244	Ref. No.	—
	gas connection thread M24x1.5 tube ø 12/16mm horizontal for PEL gas taps			
	Part No.	101463	Ref. No.	—
	screw suitable for PEL23S Qty 4 pcs			
	Part No.	528455	Ref. No.	—
	O-ring Viton thickness 2.62mm ID ø 18.72mm Qty 1 pcs			
accessories for		101092		
	Part No.	100908	Ref. No.	6A016110 6A017000
	union screw thread M10x1 for pipe ø 4mm Qty 1 pcs			
	Part No.	100909	Ref. No.	—
	union screw thread M10x1 for pipe ø 6mm Qty 1 pcs			
	Part No.	101246	Ref. No.	6A016120
	olive for pipe ø 4mm Qty 1 pcs			
	Part No.	101252	Ref. No.	—
	union nut thread M24x1.5 for pipe ø 12mm			
	Part No.	101253	Ref. No.	—
	union nut thread M24x1.5 PEL for pipe ø 16mm			
	Part No.	101254	Ref. No.	—
	union nut thread M28x1.5 tube ø 20mm			
	Part No.	101255	Ref. No.	—
	olive for pipe ø 12mm Qty 1 pcs			
	Part No.	101256	Ref. No.	—
	olive for pipe ø 16mm Qty 1 pcs			

Table continues overleaf



accessories for		101092		
Part No.	101257	Ref. No.	—	
	olive for pipe ø 20mm Qty 1 pcs			
Part No.	101286	Ref. No.	—	
	olive ID ø 6mm Qty 1 pcs			
Part No.	110080	Ref. No.	—	
	knob ø 70mm shaft ø 10x8mm shaft flat universal			
Part No.	112206	Ref. No.	—	
	knob dial plate silver gas tap PEL21/22/23 t.max.°C ED ø 63mm ID ø 45.5mm			

gas thermostats

SIT

630 Eurosit series

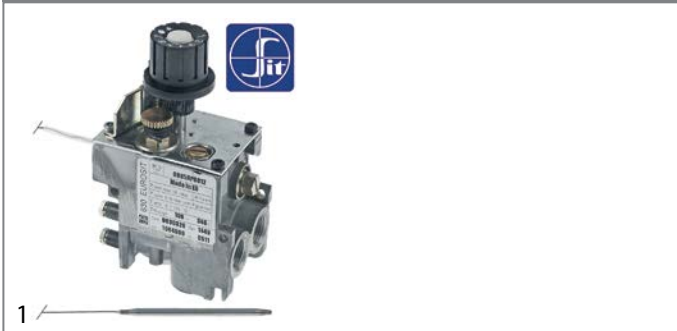

Part No.	101125	Ref. No.	8219950	
description	gas thermostat type 630 Eurosit series t.max. 340°C 100-340°C gas inlet 3/8" gas outlet 3/8" thermocouple connection M9x1 pilot connection M10x1 probe ø 4mm probe L 72mm capillary pipe 1050mm SIT			
For models:	2FX+PCF, 4FX+PCF, 74-02+2CTGG, 74-02CTGG, 76-02+4CTGG, 76-02CTGG, 76-02CTGGE, 94-04CGG, 94-04CGG1P, 94-04CGGP, 94-04CTGG, 94-04CTGGSS, 96-04CGFL, 96-04CGFL2P, 96-04CGFLP, 96-04CGG, 96-04CGG2P, 96-04CGGE, 96-04CGGE2P, 96-04CGGEP, 96-04CGGP, 96-04CTGGDX, 96-04CTGGSX, 98-04CGG, 98-04CGG2P, 98-04CGGP, 98-04CTGG			
accessories for		101125		
	Part No.	100825	Ref. No.	—
gas tap spindle shaft ø 8x6.5mm shaft L 22/14mm suitable for EUROSIT				
	Part No.	100904	Ref. No.	6A011608
locking screw M10x1 for pipe ø 4mm Qty 1 pcs				
	Part No.	100905	Ref. No.	—
locking screw M10x1 for pipe ø 6mm Qty 1 pcs				
	Part No.	100949	Ref. No.	—
gasket suitable for 630 Eurosit series				
	Part No.	101273	Ref. No.	6A011625
olive for pipe ø 12mm L 9.5mm brass Qty 1 pcs suitable for universal				
	Part No.	101276	Ref. No.	6A011620
union screw thread 3/8" tube ø 12mm Qty 1 pcs				
	Part No.	101333	Ref. No.	8219951
plug thread 3/8" with O-ring				
	Part No.	101390	Ref. No.	—
gas tap spindle shaft ø 6x4.6mm shaft L 32/15mm gas tap with ignition flame suitable for ZANUSSI, MARENO for gas thermostat EUROSIT				

accessories for		101125		
Part No.	101392	Ref. No.	—	
	adapter suitable for 630 Eurosit series			
Part No.	110357	Ref. No.	—	
	gas tap spindle shaft ø 8x6.5mm shaft L 36/12mm suitable for 630 Eurosit series			
Part No.	110358	Ref. No.	—	
	adapter shaft ø 10x8mm shaft L 29/18mm suitable for 630 Eurosit series			

gas valves and ignition boxes

gas control valves

SIT





NOVASIT



Part No.	101908	Ref. No.	6A050010	
description	gas valve SIT series Novasit 820 230V 50Hz gas inlet 1/2" gas outlet 1/2" thermocouple connection M9x1 pilot connection M10x1 ignition pressurebar pressure regulator connection blind equiv. no. 0.820.018 output pilot burner M10x1 input pressure max. 60bar setting range 3-30bar			
For models:	74-02KBGB, 74-02KBGBI, 74-02KBGMB, 74-02KBGMBI			
spare parts for		101908		
	Part No.	101065	Ref. No.	—
magnet unit with cable L 44mm D1 ø 30mm D2 ø 20mm suitable for NOVASIT				
	Part No.	101313	Ref. No.	—
solenoid coil 230V 50Hz				
accessories for		101908		
	Part No.	100006	Ref. No.	—
piezoelectric igniter suitable for ELETTROSIT body plastic blowing connection ø2.4mm ø 14mm				
	Part No.	101305	Ref. No.	—
gas connection straight 1/2" flange 45x45mm ELETTROSIT/V4400/4600/4605 suitable for SIT/HONEYWELL hole distance 36x36mm				
	Part No.	101306	Ref. No.	—
gas connection angled flange 45x45mm hole distance 36x36mm 1/2" ELETTROSIT/V4400/4600/4605 screw with O-ring suitable for SIT/HONEYWELL				
	Part No.	101307	Ref. No.	—
gas connection straight flange 45x45mm hole distance 36x36mm 3/4" ELETTROSIT/V4400/4600/4605 screw with O-ring suitable for SIT/HONEYWELL				
	Part No.	101308	Ref. No.	—
gas connection angled flange 45x45mm hole distance 36x36mm 3/4" ELETTROSIT/V4400/4600/4605 screw with O-ring suitable for SIT/HONEYWELL				

Table continues overleaf









accessories for		101908		
	Part No.	101312	Ref. No.	6A050003
	microswitch			
	Part No.	101314	Ref. No.	—
	solenoid coil 24V 50Hz			
	Part No.	101317	Ref. No.	—
	plug with cable L 1000mm suitable for NOVASIT			
	Part No.	101318	Ref. No.	—
	cover cap for solenoid coil suitable for NOVASIT			



Part No.		106001	Ref. No.	3103650
description		gas valve SIT series Novasit 826 230V 50Hz gas inlet 1/2" gas outlet 1/2" thermocouple connection pilot connection closed ignition pressure 3-5mbar pressure range 2-50mbar pressure regulator connection standard equiv. no. 0.826.011 power supply for modulator 230VAC rectified		
For models:		NECVM10GS2, NECVM20GS2, NECVM21GS2, NECVM6GS2, NECVP10GS2, NECVP20GS2, NECVP21GS2, NECVP6GS2		

spare parts for		106001		
	Part No.	101542	Ref. No.	—
	solenoid coil 50Hz NOVA 822/826/827 suitable for NOVASIT 230V			

accessories for		106001		
	Part No.	101305	Ref. No.	—
	gas connection straight 1/2" flange 45x45mm ELETROSIT/V4400/4600/4605 suitable for SIT/HONEYWELL hole distance 36x36mm			
	Part No.	101306	Ref. No.	—
	gas connection angled flange 45x45mm hole distance 36x36mm 1/2" ELETROSIT/V4400/4600/4605 screw with O-ring suitable for SIT/HONEYWELL			
	Part No.	101307	Ref. No.	—
	gas connection straight flange 45x45mm hole distance 36x36mm 3/4" ELETROSIT/V4400/4600/4605 screw with O-ring suitable for SIT/HONEYWELL			
	Part No.	101308	Ref. No.	—
	gas connection angled flange 45x45mm hole distance 36x36mm 3/4" ELETROSIT/V4400/4600/4605 screw with O-ring suitable for SIT/HONEYWELL			
	Part No.	101859	Ref. No.	—
	panel-mounted inlet with cable L 1000mm for rectifier suitable for NOVASIT			

accessories			
	1		
Part No.	101312	Ref. No.	6A050003
description		microswitch	
For models:		74-02KBGB, 74-02KBGBI, 74-02KBGMB, 74-02KBGMBI	

ignition boxes

BRAHMA			
	1		
Part No.	102337	Ref. No.	3103675
description		ignition box BRAHMA type CM11F electrodes 2 waiting time 1.5s safety time 5s 220-240V 7VA 50-60Hz	
For models:		NECVM10GS2, NECVM20GS2, NECVM21GS2, NECVM6GS2, NECVP10GS2, NECVP20GS2, NECVP21GS2, NECVP6GS2	

ignition parts
pilot burners

SIT			
100 series			
accessories			
pilot burner bottom parts			

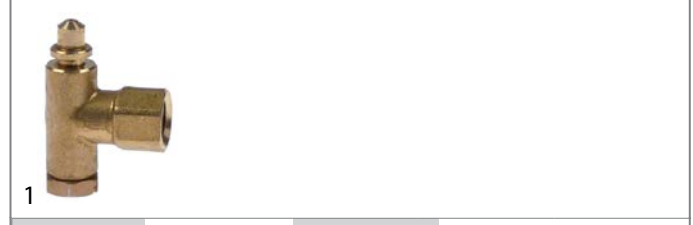

Part No.		107701	Ref. No.	2510359
description		pilot burner bottom part SIT 100 series nozzle ø 0.2mm		
For models:		4FX+PCF, 74-02+2CTGG, 76-02CTG, 76-02CTGG, 76-02CTGGE, 76-02TCTGG, 92-04CG, 92-04CG1P, 92-04CGP, 92-04TCG, 92-04TCG1P, 92-04TCGP, 94-04CG, 94-04CG1P, 94-04CGE, 94-04CGE1P, 94-04CGEP, 94-04CGG, 94-04CGG1P, 94-04CGGP, 94-04CGP, 94-04CTGGSS, 94-04CTGSS, 94-04TCG, 94-04TCG1P, 94-04TCGP, 94-04TCTGSS, 96-04CG, 96-04CG2P, 96-04CGE, 96-04CGE2P, 96-04CGEE, 96-04CGEE2P, 96-04CGEEP, 96-04CGEP, 96-04CGFL, 96-04CGFL2P, 96-04CGFLP, 96-04CGG, 96-04CGG2P, 96-04CGGE, 96-04CGGE2P, 96-04CGGEP, 96-04CGGP, 96-04CGP, 96-04CTGDX, 96-04CTGEDX, 96-04CTGESX, 96-04CTGGDX, 96-04CTGGSX...(Other models you can see in the webshop)		











spare parts for		107701		
	Part No.	100245	Ref. No.	6A013101
	pilot burner nozzle LPG code 20 bore ø 0.2mm Qty 1 pcs thread M8x0.75			
	Part No.	100916	Ref. No.	—
	compression spring for pilot burner Qty 1 pcs			

Table continues overleaf



spare parts for		107701	
	Part No.	100917	Ref. No. —
	gasket for pilot burner Qty 1 pcs aluminium		
	Part No.	100918	Ref. No. —
	screw for pilot burner		
accessories for		107701	
	Part No.	100246	Ref. No. —
	pilot burner nozzle natural gas bore \varnothing 0.35mm Qty 1 pcs thread M8x0.75		
	Part No.	100904	Ref. No. 6A011608
	locking screw M10x1 for pipe \varnothing 4mm Qty 1 pcs		
	Part No.	100905	Ref. No. —
	locking screw M10x1 for pipe \varnothing 6mm Qty 1 pcs		
	Part No.	102110	Ref. No. —
	pilot tube copper pipe \varnothing 4mm thickness 1mm L 3000mm		
	Part No.	102111	Ref. No. —
	pilot tube copper pipe \varnothing 6mm thickness 1mm L 3000mm		
	Part No.	102742	Ref. No. —
	pilot burner nozzle LPG code 25 bore \varnothing 0.25mm Qty 1 pcs		

pilot burner nozzles			
	1		
Part No.	100245	Ref. No.	6A013101
description pilot burner nozzle LPG code 20 bore \varnothing 0.2mm Qty 1 pcs thread M8x0.75			
For models:	4FX+PCF, 74-02+2CTGG, 76-02CTG, 76-02CTGG, 76-02CTGGE, 76-02TCTGG, 92-04CG, 92-04CG1P, 92-04CGP, 92-04TCG, 92-04TCG1P, 92-04TCGP, 94-04CG, 94-04CG1P, 94-04CGE, 94-04CGE1P, 94-04CGEP, 94-04CGG, 94-04CGG1P, 94-04CGGP, 94-04CGP, 94-04CTGGSS, 94-04CTGSS, 94-04TCG, 94-04TCG1P, 94-04TCGP, 94-04TCTGSS, 96-04CG, 96-04CG2P, 96-04CGE, 96-04CGE2P, 96-04CGEE, 96-04CGEE2P, 96-04CGEEP, 96-04CGEP, 96-04CGFL, 96-04CGFL2P, 96-04CGFLP, 96-04CGG, 96-04CGG2P, 96-04CGGE, 96-04CGGE2P, 96-04CGGEP, 96-04CGGP, 96-04CGP, 96-04CTGDX, 96-04CTGEDX, 96-04CTGESX, 96-04CTGGDX, 96-04CTGGSX...(Other models you can see in the webshop)		

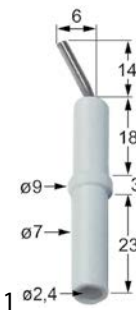











ignition electrodes			
	1		
Part No.	100707	Ref. No.	6A013302
description ignition electrode D1 \varnothing 7mm D2 \varnothing 9mm connection \varnothing 2.4mm L1 14mm L2 6mm BL1 18mm BL2 3mm BL3 23mm to clip Qty 1 pcs			
For models:	2FX+PCF, 4FX+PCF, 74-02+2CTGG, 74-02CTG, 74-02CTGE, 74-02CTGG, 74-02KBGB, 74-02KBGBI, 74-02KBGMB, 74-02KBGMBI, 74-02TCTG, 76-02+4CTGG, 76-02CTG, 76-02CTGG, 76-02CTGGE, 76-02TCTGG, 92-04PLG, 92-04TPLG, 94-04CTG, 94-04CTGE, 94-04CTGG, 94-04CTGSS, 94-04CTGSS, 94-04PLG, 94-04TCTG, 94-04TCTGSS, 94-04TPLG, 96-04CGFL, 96-04CGFL2P, 96-04CGFLP, 96-04CTGDX, 96-04CTGEDX, 96-04CTGESX, 96-04CTGGDX, 96-04CTGGSX, 96-04CTGSX, 96-04TCTGDX, 96-04TCTGSX, 98-04CTG, 98-04CTGE, 98-04CTGG, 98-04TCTG		

miscellaneous			
	1		
Part No.	100885	Ref. No.	6A013104
description air mixing sleeve for pilot burner Qty 1 pcs			
For models:	92-04CG, 92-04CG1P, 92-04CGP, 92-04TCG, 92-04TCG1P, 92-04TCGP, 94-04CG, 94-04CG1P, 94-04CGE, 94-04CGE1P, 94-04CGEP, 94-04CGG, 94-04CGG1P, 94-04CGGP, 94-04CGP, 94-04CTGGSS, 94-04CTGSS, 94-04TCG, 94-04TCG1P, 94-04TCGP, 94-04TCTGSS, 96-04CG, 96-04CG2P, 96-04CGE, 96-04CGE2P, 96-04CGEE, 96-04CGEE2P, 96-04CGEEP, 96-04CGEP, 96-04CGFL, 96-04CGFL2P, 96-04CGFLP, 96-04CGG, 96-04CGG2P, 96-04CGGE, 96-04CGGE2P, 96-04CGGEP, 96-04CGGP, 96-04CGP, 96-04CTGDX, 96-04CTGEDX, 96-04CTGESX, 96-04CTGGDX, 96-04CTGGSX, 96-04CTGSX, 96-04TCTG, 96-04TCTG2P, 96-04TCTGP, 96-04TCTGDX, 96-04TCTGSX...(Other models you can see in the webshop)		

POLIDORO			
pilot burners			
	1		
Part No.	100076	Ref. No.	6A013220
description pilot burner POLIDORO 3 flames natural gas code 29.2 gas connection 6mm			
For models:	2FX+PCF, 4FX+PCF, 74-02+2CTGG, 74-02CTG, 74-02CTGE, 74-02CTGG, 74-02KBGB, 74-02KBGBI, 74-02KBGMB, 74-02KBGMBI, 74-02TCTG, 76-02+4CTGG, 76-02CTG, 76-02CTGG, 76-02CTGGE, 76-02TCTGG, 92-04PLG, 92-04TPLG, 94-04CTG, 94-04CTGE, 94-04CTGG, 94-04CTGSS, 94-04CTGSS, 94-04PLG, 94-04TCTG, 94-04TCTG, 94-04TCTGSS, 94-04TPLG, 96-04CGFL, 96-04CGFL2P, 96-04CGFLP, 96-04CTGDX, 96-04CTGEDX, 96-04CTGESX, 96-04CTGGDX, 96-04CTGGSX, 96-04CTGSX, 96-04TCTGDX, 96-04TCTGSX, 98-04CTG, 98-04CTGE, 98-04CTGG, 98-04TCTG		
spare parts for	100076		
	Part No.	100907	Ref. No. —
	screw connection thread M10x1 Qty 1 pcs type SEF 1 \varnothing mm for thermocouple		

Table continues overleaf



accessories for		100076	
Part No.	100000	Ref. No.	—
	pilot burner nozzle POLIDORO LPG code 22 bore \varnothing 0.22mm Qty 1 pcs		
	pilot burner nozzle POLIDORO LPG code 20 bore \varnothing 0.2mm Qty 1 pcs		
	pilot burner nozzle POLIDORO natural gas code 40 bore \varnothing 0.4mm Qty 1 pcs		
	ignition electrode connection M4 Qty 1 pcs		
	screw connection thread M10x1 for ignition electrode brass Qty 1 pcs WS 10		6A011707
	screw connection thread M10x1 Qty 1 pcs type SEF 1 \varnothing mm for thermocouple		—
	union screw thread M10x1 for pipe \varnothing 4mm Qty 1 pcs		6A016110 6A017000
	union screw thread M10x1 for pipe \varnothing 6mm Qty 1 pcs		—
	pilot tube copper pipe \varnothing 4mm thickness 1mm L 3000mm		—
	pilot tube copper pipe \varnothing 6mm thickness 1mm L 3000mm		—
	union screw thread M10x1 for pipe \varnothing 4mm Qty 5 pcs		—
	union screw thread M10x1 for pipe \varnothing 6mm Qty 5 pcs		—
	pilot burner nozzle POLIDORO natural gas code 25.2 bore \varnothing 2x0.25mm Qty 1 pcs 2 bores		—
	olive for pipe \varnothing 4mm Qty 1 pcs		—
	olive for pipe \varnothing 6mm Qty 1 pcs		—
	pilot burner nozzle POLIDORO natural gas code 27.2 bore \varnothing 2x0.27mm Qty 1 pcs		6A013230
	pilot burner nozzle POLIDORO LPG code 16.2 bore \varnothing 2x0.16mm Qty 1 pcs		6A013240
	pilot burner nozzle POLIDORO natural gas code 27.2A bore \varnothing 2x 0.27mm Qty 1 pcs		—
	pilot burner nozzle POLIDORO LPG code 24 bore \varnothing 0.24mm Qty 1 pcs		—

electrodes



Part No.	100707	Ref. No.	6A013302
description	ignition electrode D1 \varnothing 7mm D2 \varnothing 9mm connection \varnothing 2.4mm L1 14mm L2 6mm BL1 18mm BL2 3mm BL3 23mm to clip Qty 1 pcs		
For models:	2FX+PCF, 4FX+PCF, 74-02+2CTGG, 74-02CTG, 74-02CTGE, 74-02CTGG, 74-02KBGB, 74-02KBGBI, 74-02KBGMB, 74-02KBGMBI, 74-02TCTG, 76-02+4CTGG, 76-02CTG, 76-02CTGG, 76-02CTGGE, 76-02TCTGG, 92-04PLG, 92-04TPLG, 94-04CTG, 94-04CTGE, 94-04CTGG, 94-04CTGGSS, 94-04CTGSS, 94-04PLG, 94-04TCTG, 94-04TCTGSS, 94-04TPLG, 96-04CGFL, 96-04CGFL2P, 96-04CGFLP, 96-04CTGDX, 96-04CTGDX, 96-04CTGESX, 96-04CTGGDX, 96-04CTGGSSX, 96-04CTGSX, 96-04TCTGDX, 96-04TCTGSX, 98-04CTG, 98-04CTGE, 98-04CTGG, 98-04TCTG		

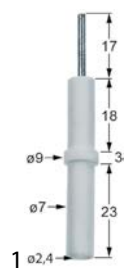

Part No.	106619	Ref. No.	6A013301
description	ignition electrode D1 \varnothing 7mm D2 \varnothing 9mm L1 17mm BL1 18mm BL2 3mm BL3 23mm to clip connection \varnothing 2.4mm		
For models:	94-04CGG, 94-04CGG1P, 94-04CGGP, 94-04CTGG, 94-04CTGGSS, 96-04CGG, 96-04CGG2P, 96-04CGGE, 96-04CGGE2P, 96-04CGGEP, 96-04CGGP, 96-04CTGGDX, 96-04CTGGSSX, 98-04CGG, 98-04CGG2P, 98-04CGGP, 98-04CTGG		



Part No.	102335	Ref. No.	3104900
description	ignition electrode flange length 23mm flange width 15mm D1 \varnothing 7mm L1 13mm L2 30mm BL1 22mm BL2 30mm cable length 1100mm fixing dimensions \varnothing 5x4mm with flange		
For models:	NECVM10GS2, NECVM20GS2, NECVM21GS2, NECVM6GS2, NECVP10GS2, NECVP20GS2, NECVP21GS2, NECVP6GS2		



			
1			
Part No.	100906	Ref. No.	6A011707
description	screw connection thread M10x1 for ignition electrode brass Qty 1 pcs WS 10		
For models:	94-04CGG, 94-04CGG1P, 94-04CGGP, 94-04CTGG, 94-04CTGGSS, 96-04CGG, 96-04CGG2P, 96-04CGGE, 96-04CGGE2P, 96-04CGGEP, 96-04CGGP, 96-04CTGGDX, 96-04CTGGGSX, 98-04CGG, 98-04CGG2P, 98-04CGGP, 98-04CTGG		

ignition cables

pre-assembled cables

			
1			
Part No.	102181	Ref. No.	6A041300 6A041410
description	ignition cable cable length 1500mm connection $\varnothing 2.4\text{mm}$ / $\varnothing 2.4\text{mm}$		
For models:	2FX+PCF, 4FX+PCF, 74-02+2CTGG, 74-02CTGG, 74-02KBGB, 74-02KBGBI, 74-02KBGMB, 74-02KBGMBI, 76-02+4CTGG, 76-02CTGG, 76-02CTGGE, 96-04CGFL, 96-04CGFL2P, 96-04CGFLP		

			
1			
Part No.	100016	Ref. No.	2510698
description	ignition cable cable length 900mm connection $\varnothing 2.4\text{mm}$ / $\varnothing 2.4\text{mm}$		
For models:	92-04PLG, 92-04TPLG, 94-04CGG, 94-04CGG1P, 94-04CGGP, 94-04CTGG, 94-04CTGGSS, 94-04PLG, 94-04TPLG, 96-04CGG, 96-04CGG2P, 96-04CGGE, 96-04CGGE2P, 96-04CGGEP, 96-04CGGP, 96-04CTGGDX, 96-04CTGGGSX, 98-04CGG, 98-04CGG2P, 98-04CGGP, 98-04CTGG		

piezoelectric igniters

mounting diameter 18mm

			
1			
Part No.	100009	Ref. No.	6A041105
description	piezoelectric igniter body plastic blowing mounting $\varnothing 18\text{mm}$ connection $\varnothing 2.4\text{mm}$ front measurements 26mm M18x1.5		
For models:	2FX+PCF, 4FX+PCF, 74-02+2CTGG, 74-02CTGG, 76-02+4CTGG, 76-02CTGG, 76-02CTGGE, 92-04PLG, 92-04TPLG, 94-04CGG, 94-04CGG1P, 94-04CGGP, 94-04CTGG, 94-04CTGGSS, 94-04CTGSS, 94-04PLG, 94-04TCTGSS, 94-04TPLG, 96-04CGFL, 96-04CGFL2P, 96-04CGFLP, 96-04CGG, 96-04CGG2P, 96-04CGGE, 96-04CGGE2P, 96-04CGGEP, 96-04CGGP, 96-04CTGGDX, 96-04CTGGGSX, 98-04CGG, 98-04CGG2P, 98-04CGGP, 98-04CTGG		
accessories for	100009		
	Part No.	101339	Ref. No. —
	cover cap for piezoelectric igniter		
	Part No.	106869	Ref. No. —
	cover cap for piezoelectric igniter ID $\varnothing 22\text{mm}$ ED $\varnothing 35\text{mm}$ H 25mm		

accessories for	100009		
	Part No.	107931	Ref. No. —
	cover cap for piezoelectric igniter ID $\varnothing 21\text{mm}$ ED $\varnothing 36\text{mm}$		

accessories

			
1			
Part No.	691392	Ref. No.	822160540
description	ring for piezoelectric igniter ID $\varnothing 18\text{mm}$ ED $\varnothing 30\text{mm}$ H 2mm mounting $\varnothing 22\text{mm}$		
For models:	92-04PLG, 92-04TPLG, 94-04CGG, 94-04CGG1P, 94-04CGGP, 94-04CTGG, 94-04CTGGSS, 94-04CTGSS, 94-04PLG, 94-04TCTGSS, 94-04TPLG, 96-04CGFL, 96-04CGFL2P, 96-04CGFLP, 96-04CGG, 96-04CGG2P, 96-04CGGE, 96-04CGGE2P, 96-04CGGEP, 96-04CGGP, 96-04CTGGDX, 96-04CTGGGSX, 98-04CGG, 98-04CGG2P, 98-04CGGP, 98-04CTGG		

ignition units

			
1			
Part No.	102485	Ref. No.	6A050100
description	ignition unit outputs 2 220-240VAC 0.6VA 50-60Hz		
For models:	74-02KBGB, 74-02KBGBI, 74-02KBGMB, 74-02KBGMBI		

thermocouples

plug-in thermocouples

plug-in thermocouples standard

with barrel socket $\varnothing 6(6.5)\text{mm}$

thermocouples SIT

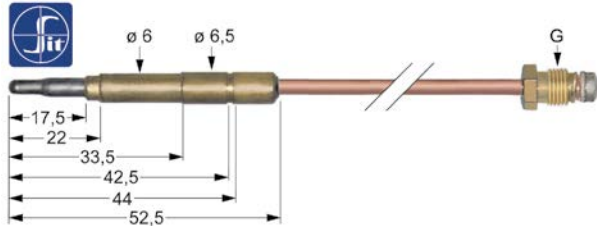
			
1			
Part No.	107608	Ref. No.	6A011912
description	thermocouple SIT M9x1 L 500mm plug connection $\varnothing 6.0(6.5)\text{mm}$		
For models:	2FX+PCF, 4FX+PCF, 74-02+2CTGG, 74-02CTG, 74-02CTGE, 74-02CTGG, 74-02TCTG, 76-02+4CTGG, 76-02CTG, 76-02CTGGE, 76-02CTGGE, 76-02TCTGG, 92-04PLG, 92-04TPLG, 94-04PLG, 94-04TPLG		



Part No.	107611	Ref. No.	6A011900 6A011904
description	thermocouple SIT M9x1 L 850mm plug connection ø6.0(6.5)mm		
For models:	2FX+PCF, 4FX+PCF, 74-02+2CTGG, 74-02KBGB, 74-02KBGBI, 74-02KBGMB, 74-02KBGMBI, 76-02+4CTGG, 94-04CGG, 94-04CGG1P, 94-04CGGP, 94-04CTG, 94-04CTGE, 94-04CTGG, 94-04CTGGSS, 94-04CTGSS, 94-04TCTG, 94-04TCTGSS, 96-04CGG, 96-04CGG2P, 96-04CGGE, 96-04CGGE2P, 96-04CGGEP, 96-04CGGP, 96-04CTGDX, 96-04CTGEDX, 96-04CTGESX, 96-04CTGGDX, 96-04CTGGSX, 96-04CTGSX, 96-04TCTGDX, 96-04TCTGSX, 98-04CGG, 98-04CGG2P, 98-04CGGP, 98-04CTG, 98-04CTGE, 98-04CTGG, 98-04TCTG		

thermocouples with aluminised tip

Part No.	102045	Ref. No.	6A011800
description	thermocouple M9x1 L 1500mm plug connection ø6.0(6.5)mm		
For models:	2FX+PCF, 4FX+PCF, 74-02+2CTGG, 74-02CTGG, 76-02+4CTGG, 76-02CTGG, 76-02CTGGE, 96-04CGFL, 96-04CGFL2P, 96-04CGFLP		

accessories

screws

Part No.	100920	Ref. No.	6A013401
description	thermocouple fitting thread M8x1 / M9x1 Qty 1 pcs		
For models:	96-04CTGDX, 96-04CTGEDX, 96-04CTGESX, 96-04CTGGDX, 96-04CTGGSX, 96-04CTGSX, 96-04TCTGDX, 96-04TCTGSX, 98-04CTG, 98-04CTGE, 98-04CTGG, 98-04TCTG		

gas burners

bar burners

bar burners

Part No.	103155	Ref. No.	2519270
description	bar burner 3 row L 610mm W 280mm ømm H 60mm chargrill		
For models:	92-04PLG, 92-04TPLG, 94-04PLG, 94-04TPLG		

Part No.	105442	Ref. No.	2510651
description	bar burner ø 50mm Wmm Hmm L 345mm flange with bolt M4 flange width 65mm flange length 71mm fryer		
For models:	74-02KBGB, 74-02KBGBI, 74-02KBGMB, 74-02KBGMBI		

Part No.	105777 ¹	Ref. No.	3104830
description	bar burner ø 50mm Wmm Hmm L 440mm with bolt M5x25 flange width 57mm flange length 57mm combi-steamer		
For models:	NECVM10GS2, NECVM6GS2, NECVP10GS2, NECVP6GS2		

¹for ovens with 6+10 grids

Part No.	105779 ¹	Ref. No.	3104840
description	bar burner ø 50mm Wmm Hmm L 440mm with bolt M5x25 flange width 57mm flange length 57mm gas range		
For models:	NECVM21GS2, NECVP21GS2		

¹for ovens with 20 grids



			
1			
Part No.	105778	Ref. No.	3104850
description	bar burner ø 50mm Wmm Hmm L 600mm flange width 57mm flange length 57mm convection oven		
For models:	NECVM20GS2, NECVP20GS2		

			
1			
Part No.	105436	Ref. No.	2510697
description	bar burner ø 50mm Wmm Hmm L 608mm flange width 71mm gas range flange ø 75mm		
For models:	94-04CGG, 94-04CGG1P, 94-04CGGP, 94-04CTGG, 94-04CTGGSS, 96-04CGG, 96-04CGG2P, 96-04CGGE, 96-04CGGE2P, 96-04CGGEP, 96-04CGGP, 96-04CTGGDX, 96-04CTGGSX, 98-04CGG, 98-04CGG2P, 98-04CGGP, 98-04CTGG		











			
1			
Part No.	211048	Ref. No.	2519602
description	lava rock grid L 575mm W 305mm H 25mm		
For models:	92-04PLG, 92-04TPLG, 94-04PLG, 94-04TPLG		

lava rock grids

			
1			
Part No.	211048	Ref. No.	2519602
description	lava rock grid L 575mm W 305mm H 25mm		
For models:	92-04PLG, 92-04TPLG, 94-04PLG, 94-04TPLG		

accessories

nozzle holders

			
1			
Part No.	105290	Ref. No.	6A014708
description	nozzle holder nozzle mounting M11x1		
For models:	2FX+PCF, 4FX+PCF, 74-02+2CTGG, 74-02CTG, 74-02CTGE, 74-02CTGG, 74-02TCTG, 76-02+4CTGG, 76-02CTG, 76-02CTGG, 76-02CTGGE, 76-02TCTGG, 92-04CG, 92-04CG1P, 92-04CGP, 92-04PLG, 92-04TCG, 92-04TCG1P, 92-04TCGP, 92-04TPLG, 94-04CG, 94-04CG1P, 94-04CGE, 94-04CGE1P, 94-04CGEP, 94-04CGG, 94-04CGG1P, 94-04CGGP, 94-04CGP, 94-04CTGGSS, 94-04CTGSS, 94-04PLG, 94-04TCG, 94-04TCG1P, 94-04TCGP, 94-04TCTGSS, 94-04TPLG, 96-04CG, 96-04CG2P, 96-04CGE, 96-04CGE2P, 96-04CGEE, 96-04CGEE2P, 96-04CGEEP, 96-04CGEP, 96-04CGFL, 96-04CGFL2P, 96-04CGFLP, 96-04CGG, 96-04CGG2P..(Other models you can see in the webshop)		
accessories for	105290		
	Part No.	105280	Ref. No. 2510351
	burner head C for burner cap ø 80mm 3.5kW		
	Part No.	105281	Ref. No. 2510352
	burner cap C ø 80mm 3.5kW with central hole ID ø 32mm		
	Part No.	105283	Ref. No. 2510354
	burner head D for burner cap ø 105mm 5.6kW		
	Part No.	105284	Ref. No. 2510355
	burner cap ID ø 54mm D ø 105mm 5.6kW with central hole		
	Part No.	105285	Ref. No. 2510353
	venturi D for burner cap ø 105mm 5.6kW		
	Part No.	105286	Ref. No. 2510357
	burner head E for burner cap ø 125mm 7kW		
	Part No.	105287	Ref. No. 2510341 2510358
	burner cap E ø 125mm 7kW with central hole		
	Part No.	105288	Ref. No. 2510340 2510356
	venturi E for burner cap ø 125mm 7kW		
	Part No.	105289	Ref. No. 2519002
	air mixing sleeve L 50mm ED ø 45mm ID ø 42mm aluminium		



gas nozzles

pilot burner nozzles

pilot burner nozzles POLIDORO



Part No.	106704	Ref. No.	6A013240
description	pilot burner nozzle POLIDORO LPG code 16.2 bore ø 2x0.16mm Qty 1 pcs		
For models:	2FX+PCF, 4FX+PCF, 74-02+2CTGG, 74-02CTG, 74-02CTGE, 74-02CTGG, 74-02TCTG, 76-02+4CTGG, 76-02CTG, 76-02CTGG, 76-02CTGGE, 76-02TCTGG, 92-04PLG, 92-04TPLG, 94-04CTG, 94-04CTGE, 94-04CTGG, 94-04CTGGSS, 94-04CTGSS, 94-04PLG, 94-04TCTG, 94-04TCTGSS, 94-04TPLG, 96-04CGFL, 96-04CGFL2P, 96-04CGFLP, 96-04CTGDX, 96-04CTGEDX, 96-04CTGESX, 96-04CTGGDX, 96-04CTGGSX, 96-04CTGSX, 96-04TCTGDX, 96-04TCTGSX, 98-04CTG, 98-04CTGE, 98-04CTGG, 98-04TCTG		



Part No.	106705	Ref. No.	2510332
description	pilot burner nozzle POLIDORO LPG code 38-R bore ø 0.38mm Qty 1 pcs		
For models:	2FX+PCF, 4FX+PCF, 74-02+2CTGG, 74-02CTG, 74-02CTGE, 74-02CTGG, 74-02TCTG, 76-02+4CTGG, 76-02CTG, 76-02CTGG, 76-02CTGGE, 76-02TCTGG, 92-04PLG, 92-04TPLG, 94-04CTG, 94-04CTGE, 94-04CTGG, 94-04CTGGSS, 94-04CTGSS, 94-04PLG, 94-04TCTG, 94-04TCTGSS, 94-04TPLG, 96-04CTGDX, 96-04CTGEDX, 96-04CTGESX, 96-04CTGGDX, 96-04CTGGSX, 96-04CTGSX, 96-04TCTGDX, 96-04TCTGSX, 98-04CTG, 98-04CTGE, 98-04CTGG, 98-04TCTG		



Part No.	106703	Ref. No.	6A013230
description	pilot burner nozzle POLIDORO natural gas code 27.2 bore ø 2x0.27mm Qty 1 pcs		
For models:	2FX+PCF, 4FX+PCF, 74-02+2CTGG, 74-02CTG, 74-02CTGE, 74-02CTGG, 74-02TCTG, 76-02+4CTGG, 76-02CTG, 76-02CTGG, 76-02CTGGE, 76-02TCTGG, 92-04PLG, 92-04TPLG, 94-04CTG, 94-04CTGE, 94-04CTGG, 94-04CTGGSS, 94-04CTGSS, 94-04PLG, 94-04TCTG, 94-04TCTGSS, 94-04TPLG, 96-04CGFL, 96-04CGFL2P, 96-04CGFLP, 96-04CTGDX, 96-04CTGEDX, 96-04CTGESX, 96-04CTGGDX, 96-04CTGGSX, 96-04CTGSX, 96-04TCTGDX, 96-04TCTGSX, 98-04CTG, 98-04CTGE, 98-04CTGG, 98-04TCTG		

pilot burner nozzles SIT

100 series



Part No.	100245	Ref. No.	6A013101
description	pilot burner nozzle LPG code 20 bore ø 0.2mm Qty 1 pcs thread M8x0.75		
For models:	4FX+PCF, 74-02+2CTGG, 76-02CTG, 76-02CTGG, 76-02CTGGE, 76-02TCTGG, 92-04CG, 92-04CG1P, 92-04CGP, 92-04TCC, 92-04TCG1P, 92-04TCGP, 94-04CG, 94-04CG1P, 94-04CGE, 94-04CGE1P, 94-04CGEP, 94-04CGG, 94-04CGG1P, 94-04CGGP, 94-04CGP, 94-04CTGGSS, 94-04CTGSS, 94-04TCC, 94-04TCG1P, 94-04TCGP, 94-04TCTGSS, 96-04CG, 96-04CG2P, 96-04CGE, 96-04CGE2P, 96-04CGEE, 96-04CGEE2P, 96-04CGEEP, 96-04CGEP, 96-04CGFL, 96-04CGFL2P, 96-04CGFLP, 96-04CGG, 96-04CGG2P, 96-04CGGE, 96-04CGGE2P, 96-04CGGEP, 96-04CGGP, 96-04CGP, 96-04CTGDX, 96-04CTGEDX, 96-04CTGESX, 96-04CTGGDX, 96-04CTGGSX...(Other models you can see in the webshop)		



Part No.	107170	Ref. No.	6A013103
description	pilot burner nozzle SIT natural gas bore ø 0.35mm Qty 1 pcs		
For models:	4FX+PCF, 74-02+2CTGG, 76-02CTG, 76-02CTGG, 76-02CTGGE, 76-02TCTGG, 92-04CG, 92-04CG1P, 92-04CGP, 92-04TCC, 92-04TCG1P, 92-04TCGP, 94-04CG, 94-04CG1P, 94-04CGE, 94-04CGE1P, 94-04CGEP, 94-04CGG, 94-04CGG1P, 94-04CGGP, 94-04CGP, 94-04CTGGSS, 94-04CTGSS, 94-04TCC, 94-04TCG1P, 94-04TCGP, 94-04TCTGSS, 96-04CG, 96-04CG2P, 96-04CGE, 96-04CGE2P, 96-04CGEE, 96-04CGEE2P, 96-04CGEEP, 96-04CGEP, 96-04CGFL, 96-04CGFL2P, 96-04CGFLP, 96-04CGG, 96-04CGG2P, 96-04CGGE, 96-04CGGE2P, 96-04CGGEP, 96-04CGGP, 96-04CGP, 96-04CTGDX, 96-04CTGEDX, 96-04CTGESX, 96-04CTGGDX, 96-04CTGGSX...(Other models you can see in the webshop)		

140/150 series



Part No.	100205	Ref. No.	822140380
description	pilot burner nozzle SIT LPG code 19 bore ø 0.23/0.26mm Qty 1 pcs suitable for SIT 150 series		
For models:	94-04CGG, 94-04CGG1P, 94-04CGGP, 94-04CTGG, 94-04CTGGSS, 96-04CGG, 96-04CGG2P, 96-04CGGE, 96-04CGGE2P, 96-04CGGEP, 96-04CGGP, 96-04CTGGDX, 96-04CTGGSX, 98-04CGG, 98-04CGG2P, 98-04CGGP, 98-04CTGG		



Part No.	100207	Ref. No.	6A013107
description	pilot burner nozzle SIT natural gas code 27 bore ø 0.40/0.38mm suitable for SIT 140 series		
For models:	94-04CGG, 94-04CGG1P, 94-04CGGP, 94-04CTGG, 94-04CTGGSS, 96-04CGG, 96-04CGG2P, 96-04CGGE, 96-04CGGE2P, 96-04CGGEP, 96-04CGGP, 96-04CTGGDX, 96-04CTGGSX, 98-04CGG, 98-04CGG2P, 98-04CGGP, 98-04CTGG		



gas nozzles sets



1

Part No.	106635	Ref. No.	2591721
description	gas injector set		
For models:	74-02KBGB, 74-02KBGBI, 74-02KBGMB, 74-02KBGMBI		



1

Part No.	106636	Ref. No.	2591720
description	gas injector set		
For models:	74-02KBGB, 74-02KBGBI, 74-02KBGMB, 74-02KBGMBI		



1

Part No.	106640	Ref. No.	2591722
description	gas injector set for tilting bratt pan		
For models:	74-02KBGB, 74-02KBGBI, 74-02KBGMB, 74-02KBGMBI		

auxiliary gas parts

screw connections

olives





1

Part No.	101249	Ref. No.	6A011470
description	olive for pipe ø 10mm Qty 1 pcs		
For models:	2FX+PCF, 4FX+PCF, 74-02+2CTGG, 74-02CTG, 74-02CTGE, 74-02CTGG, 74-02TCTG, 76-02+4CTGG, 76-02CTG, 76-02CTGG, 76-02CTGGE, 76-02TCTGG, 92-04CG, 92-04CG1P, 92-04CGP, 92-04PLG, 92-04TCG, 92-04TCG1P, 92-04TCGP, 92-04TPLG, 94-04CG, 94-04CG1P, 94-04CGE, 94-04CGE1P, 94-04CGEP, 94-04CGG, 94-04CGG1P, 94-04CGGP, 94-04CGP, 94-04CTGGSS, 94-04CTGSS, 94-04PLG, 94-04TCG, 94-04TCG1P, 94-04TCGP, 94-04TCTGSS, 94-04TPLG, 96-04CG, 96-04CG2P, 96-04CGE, 96-04CGE2P, 96-04CGEE, 96-04CGEE2P, 96-04CGEEP, 96-04CGEP, 96-04CGFL, 96-04CGFL2P, 96-04CGFLP, 96-04CGG, 96-04CGG2P...(Other models you can see in the webshop)		
accessories for	101249		
	Part No.	101250	Ref. No. 6A011475
union nut thread M20x1.5 for pipe ø 10mm			



1



Part No.	101278	Ref. No.	6A011480
description	olive for pipe ø 10mm Qty 1 pcs		
For models:	2FX+PCF, 4FX+PCF, 74-02+2CTGG, 74-02CTG, 74-02CTGE, 74-02CTGG, 74-02TCTG, 76-02+4CTGG, 76-02CTG, 76-02CTGG, 76-02CTGGE, 76-02TCTGG, 92-04CG, 92-04CG1P, 92-04CGP, 92-04PLG, 92-04TCG, 92-04TCG1P, 92-04TCGP, 92-04TPLG, 94-04CG, 94-04CG1P, 94-04CGE, 94-04CGE1P, 94-04CGEP, 94-04CGG, 94-04CGG1P, 94-04CGGP, 94-04CGP, 94-04CTGGSS, 94-04CTGSS, 94-04PLG, 94-04TCG, 94-04TCG1P, 94-04TCGP, 94-04TCTGSS, 94-04TPLG, 96-04CG, 96-04CG2P, 96-04CGE, 96-04CGE2P, 96-04CGEE, 96-04CGEE2P, 96-04CGEEP, 96-04CGEP, 96-04CGFL, 96-04CGFL2P, 96-04CGFLP, 96-04CGG, 96-04CGG2P...(Other models you can see in the webshop)		
accessories for	101278		
	Part No.	100943	Ref. No. —
union nut thread M17x1 tube ø 10mm			
	Part No.	101300	Ref. No. 6A011485
union nut thread M16x1.5 tube ø 10mm			
	Part No.	101478	Ref. No. —
union nut thread 3/8" for pipe ø 10mm			





1



Part No.	106638	Ref. No.	6A016300
description	olive for pipe ø 12mm L 10mm Qty 1 pcs		
For models:	2FX+PCF, 4FX+PCF, 74-02+2CTGG, 74-02CTGG, 76-02+4CTGG, 76-02CTGG, 76-02CTGGE, 92-04PLG, 92-04TPLG, 94-04CTGGSS, 94-04CTGSS, 94-04PLG, 94-04TCTGSS, 94-04TPLG, 96-04CTGDX, 96-04CTGEDX, 96-04CTGESX, 96-04CTGGDX, 96-04CTGGSX, 96-04CTGSX, 96-04TCTGDX, 96-04TCTGSX, 98-04CTG, 98-04CTGE, 98-04CTGG, 98-04TCTG		







 <p>1</p>			
Part No.	101273	Ref. No.	6A011625
description	olive for pipe ø 12mm L 9.5mm brass Qty 1 pcs suitable for universal		
For models:	2FX+PCF, 4FX+PCF, 74-02+2CTGG, 74-02CTGG, 76-02+4CTGG, 76-02CTGG, 76-02CTGGE		
accessories for	101273		
 <p>Part No. 100944 Ref. No. —</p> <p>union nut thread M18x1.5 for pipe ø 12mm</p>			
 <p>Part No. 101276 Ref. No. 6A011620</p> <p>union screw thread 3/8" tube ø 12mm Qty 1 pcs</p>			

 <p>1</p>			
Part No.	106637	Ref. No.	6A016900
description	olive for pipe ø 4mm L 7mm Qty 1 pcs		
For models:	92-04PLG, 92-04TPLG, 94-04CTG, 94-04CTGE, 94-04CTGG, 94-04CTGGSS, 94-04CTGSS, 94-04PLG, 94-04TCTG, 94-04TCTGSS, 94-04TPLG, 96-04CGFL, 96-04CGFL2P, 96-04CGFLP, 96-04CTGDX, 96-04CTGEDX, 96-04CTGESX, 96-04CTGGDX, 96-04CTGGSX, 96-04CTGSX, 96-04TCTGDX, 96-04TCTGSX, 98-04CTG, 98-04CTGE, 98-04CTGG, 98-04TCTG		

 <p>1</p>			
Part No.	101246	Ref. No.	6A016120
description	olive for pipe ø 4mm Qty 1 pcs		
For models:	2FX+PCF, 4FX+PCF, 74-02+2CTGG, 74-02CTG, 74-02CTGE, 74-02CTGG, 74-02TCTG, 76-02+4CTGG, 76-02CTG, 76-02CTGG, 76-02CTGGE, 76-02TCTGG, 92-04PLG, 92-04TPLG, 94-04CTGGSS, 94-04CTGSS, 94-04PLG, 94-04TCTGSS, 94-04TPLG, 96-04CTGDX, 96-04CTGEDX, 96-04CTGESX, 96-04CTGGDX, 96-04CTGGSX, 96-04CTGSX, 96-04TCTGDX, 96-04TCTGSX, 98-04CTGE, 98-04CTGG, 98-04TCTG, NECVM10ES2, NECVM10GS2, NECVM20ES2, NECVM20GS2, NECVM21ES2, NECVM21GS2, NECVM6ES2, NECVM6GS2, NECVP10ES2, NECVP10GS2, NECVP20ES2, NECVP20GS2, NECVP21ES2, NECVP21GS2, NECVP6ES2, NECVP6GS2		
accessories for	101246		
 <p>Part No. 100908 Ref. No. 6A016110 6A017000</p> <p>union screw thread M10x1 for pipe ø 4mm Qty 1 pcs</p>			

<p>union nuts</p>  <p>1</p>			
Part No.	101300	Ref. No.	6A011485
description	union nut thread M16x1.5 tube ø 10mm		
For models:	2FX+PCF, 4FX+PCF, 74-02+2CTGG, 74-02CTG, 74-02CTGE, 74-02CTGG, 74-02TCTG, 76-02+4CTGG, 76-02CTG, 76-02CTGG, 76-02CTGGE, 76-02TCTGG, 92-04CG, 92-04CG1P, 92-04CGP, 92-04PLG, 92-04TCG, 92-04TCG1P, 92-04TCGP, 92-04TPLG, 94-04CG, 94-04CG1P, 94-04CGE, 94-04CGE1P, 94-04CGEP, 94-04CGG, 94-04CGG1P, 94-04CGGP, 94-04CGP, 94-04CTGGSS, 94-04CTGSS, 94-04PLG, 94-04TCG, 94-04TCG1P, 94-04TCGP, 94-04TCTGSS, 94-04TPLG, 96-04CG, 96-04CG2P, 96-04CGE, 96-04CGE2P, 96-04CGEE, 96-04CGEE2P, 96-04CGEEP, 96-04CGEP, 96-04CGFL, 96-04CGFL2P, 96-04CGFLP, 96-04CGG, 96-04CGG2P...(Other models you can see in the webshop)		
accessories for	101300		
 <p>Part No. 101278 Ref. No. 6A011480</p> <p>olive for pipe ø 10mm Qty 1 pcs</p>			

 <p>1</p>			
Part No.	101250	Ref. No.	6A011475
description	union nut thread M20x1.5 for pipe ø 10mm		
For models:	2FX+PCF, 4FX+PCF, 74-02+2CTGG, 74-02CTG, 74-02CTGE, 74-02CTGG, 74-02TCTG, 76-02+4CTGG, 76-02CTG, 76-02CTGG, 76-02CTGGE, 76-02TCTGG, 92-04CG, 92-04CG1P, 92-04CGP, 92-04PLG, 92-04TCG, 92-04TCG1P, 92-04TCGP, 92-04TPLG, 94-04CG, 94-04CG1P, 94-04CGE, 94-04CGE1P, 94-04CGEP, 94-04CGG, 94-04CGG1P, 94-04CGGP, 94-04CGP, 94-04CTGGSS, 94-04CTGSS, 94-04PLG, 94-04TCG, 94-04TCG1P, 94-04TCGP, 94-04TCTGSS, 94-04TPLG, 96-04CG, 96-04CG2P, 96-04CGE, 96-04CGE2P, 96-04CGEE, 96-04CGEE2P, 96-04CGEEP, 96-04CGEP, 96-04CGFL, 96-04CGFL2P, 96-04CGFLP, 96-04CGG, 96-04CGG2P...(Other models you can see in the webshop)		
accessories for	101250		
 <p>Part No. 101249 Ref. No. 6A011470</p> <p>olive for pipe ø 10mm Qty 1 pcs</p>			

 <p>1</p>			
Part No.	101251	Ref. No.	6A016200
description	union nut thread M20x1.5 for pipe ø 12mm		
For models:	2FX+PCF, 4FX+PCF, 74-02+2CTGG, 74-02CTGG, 76-02+4CTGG, 76-02CTGG, 76-02CTGGE, 92-04PLG, 92-04TPLG, 94-04CTGGSS, 94-04CTGSS, 94-04PLG, 94-04TCTGSS, 94-04TPLG, 96-04CTGDX, 96-04CTGEDX, 96-04CTGESX, 96-04CTGGDX, 96-04CTGGSX, 96-04CTGSX, 96-04TCTGDX, 96-04TCTGSX, 98-04CTG, 98-04CTGE, 98-04CTGG, 98-04TCTG		
accessories for	101251		
 <p>Part No. 101248 Ref. No. —</p> <p>olive for pipe ø 12mm Qty 1 pcs suitable for PEL</p>			



union screws



1

Part No.	100904	Ref. No.	6A011608
description	locking screw M10x1 for pipe ø 4mm Qty 1 pcs		
For models:	92-04CG, 92-04CG1P, 92-04CGP, 92-04TCG, 92-04TCG1P, 92-04TCGP, 94-04CG, 94-04CG1P, 94-04CGE, 94-04CGE1P, 94-04CGEP, 94-04CGG, 94-04CGG1P, 94-04CGGP, 94-04CGP, 94-04CTGG, 94-04CTGGSS, 94-04CTGSS, 94-04TCG, 94-04TCG1P, 94-04TCGP, 94-04TCTGSS, 96-04CG, 96-04CG2P, 96-04CGE, 96-04CGE2P, 96-04CGEE, 96-04CGEE2P, 96-04CGEEP, 96-04CGEP, 96-04CGFL, 96-04CGFL2P, 96-04CGFLP, 96-04CGG, 96-04CGG2P, 96-04CGGE, 96-04CGGE2P, 96-04CGGEP, 96-04CGGP, 96-04CGP, 96-04CTGDX, 96-04CTGEDX, 96-04CTGESX, 96-04CTGGDX, 96-04CTGGSX, 96-04CTGSX, 96-04TCG, 96-04TCG2P, 96-04TCGP, 96-04TCTGDX...(Other models you can see in the web-shop)		







1

Part No.	100906	Ref. No.	6A011707
description	screw connection thread M10x1 for ignition electrode brass Qty 1 pcs WS 10		
For models:	94-04CGG, 94-04CGG1P, 94-04CGGP, 94-04CTGG, 94-04CTGGSS, 96-04CGG, 96-04CGG2P, 96-04CGGE, 96-04CGGE2P, 96-04CGGEP, 96-04CGGP, 96-04CTGGDX, 96-04CTGGSX, 98-04CGG, 98-04CGG2P, 98-04CGGP, 98-04CTGG		



1

Part No.	100908	Ref. No.	6A016110 6A017000	
description	union screw thread M10x1 for pipe ø 4mm Qty 1 pcs			
For models:	2FX+PCF, 4FX+PCF, 74-02+2CTGG, 74-02CTG, 74-02CTGE, 74-02CTGG, 74-02TCTG, 76-02+4CTGG, 76-02CTG, 76-02CTGG, 76-02CTGGE, 76-02TCTGG, 92-04PLG, 92-04TPLG, 94-04CTG, 94-04CTGE, 94-04CTGG, 94-04CTGGSS, 94-04CTGSS, 94-04PLG, 94-04TCTG, 94-04TCTGSS, 94-04TPLG, 96-04CGFL, 96-04CGFL2P, 96-04CGFLP, 96-04CTGDX, 96-04CTGEDX, 96-04CTGESX, 96-04CTGGDX, 96-04CTGGSX, 96-04CTGSX, 96-04TCTGDX, 96-04TCTGSX, 98-04CTG, 98-04CTGE, 98-04CTGG, 98-04TCTG			
accessories for	100908			
	Part No.	100897	Ref. No.	—
	olive for pipe ø 4mm Qty 1 pcs for pilot burner			
	Part No.	101246	Ref. No.	6A016120
	olive for pipe ø 4mm Qty 1 pcs			
	Part No.	101280	Ref. No.	—
	olive for pipe ø 4mm Qty 1 pcs			
	Part No.	101282	Ref. No.	—
	olive for pipe ø 4mm L 7.4mm Qty 1 pcs			

pressure switches



1

Part No.	541111	Ref. No.	30171010
description	pressure control pressure range adjustable 0.2- 3mbar pressure connection horizontal gas technology connection 6mm suitable for RATIONAL		

equipment-specific units

for pyroceram ranges

ceramic hobs

ceramic glass plates



1

Part No.	691407	Ref. No.	6A001400
description	ceramic plate L 550mm W 320mm thickness 6mm		
For models:	72-02VTVCV, 72-02VTTCV, 74-02VTVCV, 74-02VTCEV, 74-02VTVCV		

for convection ovens/combi-steamers

filters



1

Part No.	701580	Ref. No.	2005.0302 2005.0307
description	drain filter ø 71mm H 18mm IT M6 for combi-steamer model CPC-Linie CPC 61/101/201		

air filters



1

Part No.	692695	Ref. No.	52141300
description	filter insert L 213mm W 60mm ømm H 90mm		



doors

1

Part No.	697863	Ref. No.	3106355
description	locking screw for oven door		
For models:	NECVM10ES2, NECVM10GS2, NECVM20ES2, NECVM20GS2, NECVM21ES2, NECVM21GS2, NECVM6ES2, NECVM6GS2, NECVP10ES2, NECVP10GS2, NECVP20ES2, NECVP20GS2, NECVP21ES2, NECVP21GS2, NECVP6ES2, NECVP6GS2		

vibration pumps

1

Part No.	500580	Ref. No.	87201526
description	vibration pump 230V 60W 50/60Hz inlet ø 7 outlet ø 1/8" IT CEME type E512 with accessories duty cycle 1/2 ambient temperature max. 60°C medium temp max. 35°C overheating protection 110°C CleanJet		

miscellaneous

1

Part No.	524454	Ref. No.	84741377
description	drip rail push-in for door L 549mm metal W 24mm H 25mm		

for tilting bratt pans

gearboxes

1

Part No.	691411	Ref. No.	2510632
description	gearbox motor shaft ø 9mm flange ø 70mm transmission 1/28 drive shaft ø 14mm		
For models:	74-02KBGMB, 74-02KBGMBI		

motors

1

Part No.	601463	Ref. No.	2510631
description	motor 90W 230V 50Hz 1 phase shaft ø 9mm flange ø 80mm 1300rpm type AMM56ZAA4 ø 110mm H 150mm L 170mm Lafert 0.09kW		
For models:	74-02KBGMB, 74-02KBGMBI		

spindles

1

Part No.	691448	Ref. No.	2934500
description	bush ø 25mm		
For models:	74-02KBGB, 74-02KBGBI, 74-02KBGMB, 74-02KBGMBI		

for dishwashers

washing and rinsing systems

1

Part No.	517682	Ref. No.	10200121
description	bush for wash arm mounting pos. upper H 52mm thread 1/4" D1 ø 54mm D2 ø 41mm Qty 1 pcs		



knobs

accessories

gaskets



Part No.	112529	Ref. No.	2519490
description	gasket for knob rubber D1 ø 36mm D2 ø 46mm thickness 9mm		
For models:	72-02FREM, 72-02TVTCV, 72-02VTCV, 73-02FREM, 74-02CTE, 74-02CTEE, 74-02CTGE, 74-02FREM, 74-02KBGB, 74-02KBGBI, 74-02KBGMB, 74-02KBGMBI, 74-02NPEI, 74-02TCTE, 74-02TVTCV, 74-02VTCEV, 74-02VTCV, 92-04TVTC, 92-04VTC, 94-04CGE, 94-04CGE1P, 94-04CGEP, 94-04CTEES, 94-04CTES, 94-04CTGE, 94-04TCTES, 94-04TVTC, 94-04VTC, 94-04VTCE, 96-04CGE, 96-04CGE2P, 96-04CGEE, 96-04CGEE2P, 96-04CGEEP, 96-04CGEP, 96-04CGFL, 96-04CGFL2P, 96-04CGFLP, 96-04CGGE, 96-04CGGE2P, 96-04CGGEP, 96-04CTGEDX, 96-04CTGESX, 98-04CGE, 98-04CGE2P, 98-04CGEP, 98-04CTGE		

bracket handles



Part No.	691327	Ref. No.	8222510
description	pull handle L 119mm H 37mm mounting distance 105mm handle M6		
For models:	72-02FREM, 73-02FREM, 74-02FREM		

hinges

oven hinges

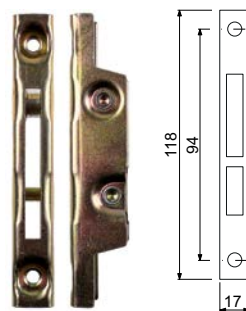

Part No.	700001	Ref. No.	6A035930
description	opposite support L 118mm W 17mm mounting distance 94mm		
For models:	2FX+PCF, 4FX+PCF, 74-02+2CTGG, 74-02CTEE, 74-02CTGE, 74-02CTGG, 74-02VTCEV, 76-02+4CTGG, 76-02CTGG, 76-02CTGGE, 94-04CEE, 94-04CGE, 94-04CGE1P, 94-04CGEP, 94-04CGG, 94-04CGG1P, 94-04CGGP, 94-04CTEES, 94-04CTGE, 94-04CTGG, 94-04CTGGSS, 94-04VTCE, 96-04CGE, 96-04CGE2P, 96-04CGEE, 96-04CGEE2P, 96-04CGEEP, 96-04CGEP, 96-04CGFL, 96-04CGFL2P, 96-04CGFLP, 96-04CGG, 96-04CGG2P, 96-04CGGE, 96-04CGGE2P, 96-04CGGEP, 96-04CGGP, 96-04CTGEDX, 96-04CTGESX, 96-04CTGGDX, 96-04CTGGSX, 98-04CGE, 98-04CGE2P, 98-04CGEP, 98-04CGG, 98-04CGG2P, 98-04CGGP, 98-04CTGE, 98-04CTGG		

handles and hand wheels

hand wheels

hand wheels





Part No.	691441	Ref. No.	6A039710
description	hand wheel ø 160mm D1 ø 32mm bore ø 20mm depth of bore 24mm thread M6 hole distance 6mm groove widthmm L1 35mm L2 60mm handle length 70mm no fold-away handle		
For models:	74-02KBGB, 74-02KBGBI		



ball handles



Part No.	691438	Ref. No.	6A019360
description	ball handle thread M8 ø 40mm black		
For models:	74-02KBGB, 74-02KBGBI, 74-02KBGMB, 74-02KBGMBI		



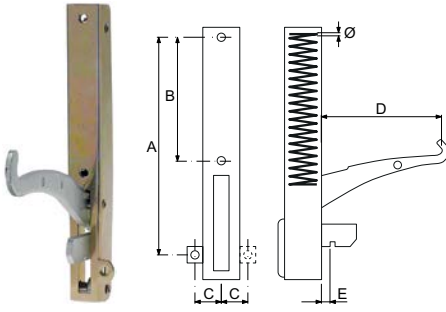

 <p>1</p>			
Part No.	700006	Ref. No.	6A035910
description	oven hinge mounting distance 173mm mounting distance 2 105mm lug mounting 14mm lever length 120mm groove distance 11mm spring thickness 3.5mm mounting ear position left spring length 112mm W 25mm		
For models:	2FX+PCF, 4FX+PCF, 74-02+2CTGG, 74-02CTEE, 74-02CTGE, 74-02CTGG, 74-02VTCEV, 76-02+4CTGG, 76-02CTGG, 76-02CTGGE, 94-04CEE, 94-04CGE, 94-04CGE1P, 94-04CGEP, 94-04CGG, 94-04CGG1P, 94-04CGGP, 94-04CTEES, 94-04CTGE, 94-04CTGG, 94-04CTGGSS, 94-04VTCE, 96-04CGE, 96-04CGE2P, 96-04CGEE, 96-04CGEE2P, 96-04CGEEP, 96-04CGEP, 96-04CGFL, 96-04CGFL2P, 96-04CGFLP, 96-04CGG, 96-04CGG2P, 96-04CGGE, 96-04CGGE2P, 96-04CGGEP, 96-04CGGP, 96-04CTGEDX, 96-04CTGESX, 96-04CTGGDX, 96-04CTGGGSX, 98-04CGE, 98-04CGE2P, 98-04CGEP, 98-04CGG, 98-04CGG2P, 98-04CGGP, 98-04CTGE, 98-04CTGG		
accessories for	700006		
	Part No.	700001	Ref. No. 6A035930 A035930
	opposite support L 118mm W 17mm mounting distance 94mm		
	Part No.	700007	Ref. No. 6A035920 A035920
	oven hinge mounting distance 173mm mounting distance 2 105mm lug mounting 14mm lever length 120mm groove distance 11mm spring thickness 3.5mm mounting ear position right spring length 112mm W 25mm		

 <p>1</p>			
Part No.	700007	Ref. No.	6A035920
description	oven hinge mounting distance 173mm mounting distance 2 105mm lug mounting 14mm lever length 120mm groove distance 11mm spring thickness 3.5mm mounting ear position right spring length 112mm W 25mm		
For models:	2FX+PCF, 4FX+PCF, 74-02+2CTGG, 74-02CTEE, 74-02CTGE, 74-02CTGG, 74-02VTCEV, 76-02+4CTGG, 76-02CTGG, 76-02CTGGE, 94-04CEE, 94-04CGE, 94-04CGE1P, 94-04CGEP, 94-04CGG, 94-04CGG1P, 94-04CGGP, 94-04CTEES, 94-04CTGE, 94-04CTGG, 94-04CTGGSS, 94-04VTCE, 96-04CGE, 96-04CGE2P, 96-04CGEE, 96-04CGEE2P, 96-04CGEEP, 96-04CGEP, 96-04CGFL, 96-04CGFL2P, 96-04CGFLP, 96-04CGG, 96-04CGG2P, 96-04CGGE, 96-04CGGE2P, 96-04CGGEP, 96-04CGGP, 96-04CTGEDX, 96-04CTGESX, 96-04CTGGDX, 96-04CTGGGSX, 98-04CGE, 98-04CGE2P, 98-04CGEP, 98-04CGG, 98-04CGG2P, 98-04CGGP, 98-04CTGE, 98-04CTGG		
accessories for	700007		
	Part No.	700001	Ref. No. 6A035930 A035930
	opposite support L 118mm W 17mm mounting distance 94mm		

door bearing

 <p>1</p>			
Part No.	693590	Ref. No.	24.00.159
description	bush mounting pos. bottom right latching		

 <p>1</p>			
Part No.	693585	Ref. No.	24.00.147
description	bush mounting pos. upper right for door		

 <p>1</p>			
Part No.	693588	Ref. No.	24.00.146
description	door bolt mounting pos. bottom right latching		

 <p>1</p>			
Part No.	693589	Ref. No.	24.00.145
description	door bolt mounting pos. bottom right latching		

 <p>1</p>			
Part No.	693587	Ref. No.	24.00.223
description	hinge mounting pos. bottom right		

 <p>1</p>			
Part No.	693583	Ref. No.	24.00.133
description	hinge mounting pos. upper right		



fittings for catering equipment

aerators and air bleeders



1

Part No.	540825	Ref. No.	6A022231
description	aerator and air bleeder thread 3/8" ET WS 24 chrome-plated L 37mm		
For models:	74-02NPEI		

drain taps

brass

drain taps



1

Part No.	542186	Ref. No.	5010054
description	drain tap 1 1/2" IT O-ring seal A 85mm B 50mm chrome-plated brass		
spare parts for	542186		



Part No.	542172	Ref. No.	—
description	clamp for pipe \varnothing 1 1/2" thickness 18mm stainless steel		



Part No.	542308	Ref. No.	—
description	cover plastic for drain tap 1 1/2"		



Part No.	542334	Ref. No.	—
description	O-ring set for drain tap 1 1/4" - 1 1/2" gaskets and grease		

accessories for

542186



Part No.	510404	Ref. No.	6A022280
description	flat gasket fibre ED \varnothing 44mm ID \varnothing 34mm thickness 2mm Qty 1 pcs		



Part No.	890087	Ref. No.	—
description	silicone grease FERMIT GLISSA tube 23g -40 to +200°C approval complies with KTW recommendation white		



Part No.	890101	Ref. No.	—
description	silicone grease FERMIT GLISSA tube 60g -40 to +200°C approval		

FITTINGS FOR CATERING EQUIPMENT METOS



1

Part No.	548001	Ref. No.	6A021050
description	drain tap 1 1/2" IT O-ring seal kettle connection with union nut A 80mm B1 68mm B2 132mm		
For models:	74-02NPEI		
spare parts for	548001		



Part No.	505092	Ref. No.	BN0119472130
description	O-ring EPDM thickness 5.34mm ID \varnothing 43.82mm Qty 1 pcs		



Part No.	540213	Ref. No.	—
description	handle ID \varnothing 5mm L 117mm		

accessories



1

Part No.	540959	Ref. No.	6A001451
description	gasket for drain tap hose ext. \varnothing 60mm ID \varnothing 50mm H 2mm		
For models:	94-04PEI100L, 94-04PEI150L		

test taps

test taps

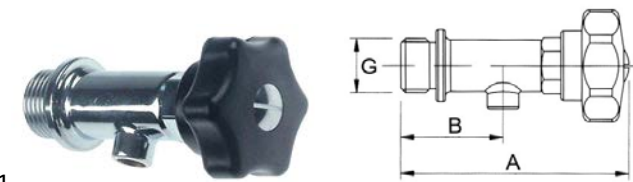

1

Part No.	540818	Ref. No.	6A022250
description	test tap thread 1/2" ET W 88mm W1 38mm		
For models:	74-02NPEI		



safety fittings

safety fittings



Part No.	514404	Ref. No.	2591677
description	safety fitting thread 3/4" 0.45bar conversion kit with manometer		
For models:	74-02NPEI		
spare parts for	514404		
	Part No.	514276	Ref. No. 6A022230
	safety fitting thread 3/4" 0.45bar H 165mm ø 65mm		
	Part No.	540825	Ref. No. 6A022231
	aerator and air bleeder thread 3/8" ET WS 24 chrome-plated L 37mm		
	Part No.	540832	Ref. No. 6A022233
	fitting support thread 1/2" ET suitable for manometer		
	Part No.	540835	Ref. No. 6A022235
	screw cap thread 3/4"		
	Part No.	541901	Ref. No. —
	manometer ø 63mm pressure range 0 up to 1bar 0 up to 14.5PSI thread 1/4" connection on the backside		





Part No.	514276	Ref. No.	6A022230
description	safety fitting thread 3/4" 0.45bar H 165mm ø 65mm		
For models:	74-02NPEI		
spare parts for	514276		
	Part No.	514094	Ref. No. —
	angle piece thread 3/8"		
	Part No.	514276	Ref. No. 6A022230
	safety fitting thread 3/4" 0.45bar H 165mm ø 65mm		
	Part No.	540825	Ref. No. 6A022231
	aerator and air bleeder thread 3/8" ET WS 24 chrome-plated L 37mm		
	Part No.	540828	Ref. No. —
	manometer siphon thread 3/8"		
	Part No.	541579	Ref. No. —
	manometer ø 52mm pressure range 0 up to 1bar connection marking 0.5 thread 1/4"		

accessories



Part No.	540832	Ref. No.	6A022233
description	fitting support thread 1/2" ET suitable for manometer		
For models:	74-02NPEI		
accessories for	540832		
	Part No.	510166	Ref. No. —
	flat gasket fibre ED ø 31.3mm ID ø 26.3mm thickness 1.2mm Qty 1 pcs		



Part No.	540835	Ref. No.	6A022235
description	screw cap thread 3/4"		
For models:	74-02NPEI		
spare parts for	540835		
	Part No.	513016	Ref. No. —
	O-ring EPDM thickness 3.53mm ID ø 26.58mm Qty 1 pcs		
accessories for	540835		
	Part No.	513016	Ref. No. —
	O-ring EPDM thickness 3.53mm ID ø 26.58mm Qty 1 pcs		



Part No.	514405	Ref. No.	6A022232
description	ring for safety fitting ø 23.5mm		
For models:	74-02NPEI		

equipment feet and end caps

equipment feet

with fixing plate



Part No.	701204	Ref. No.	2519500
description	equipment foot tube ø 52mm plate size 67x67mm hole distance 51x51mm H 120-190mm SS size 2" Qty 1 pcs		
For models:	2FX+PCF, 4FX+PCF, 72-02FREM, 72-02TVTCV, 72-02VTCV, 73-02FREM, 74-02+2CTGG, 74-02CTE, 74-02CTEE, 74-02CTG, 74-02CTGE, 74-02CTGG, 74-02FREM, 74-02KBGB, 74-02KBGBI, 74-02KBGMB, 74-02KBGMBI, 74-02NPEI, 74-02TCTG, 74-02TVTCV, 74-02VTCEV, 74-02VTCV, 76-02+4CTGG, 76-02CTG, 76-02CTGG, 76-02CTGGE, 76-02TCTGG		



gaskets

gaskets for heated units

window seals

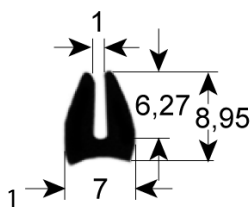

Part No.	902235	Ref. No.	5012.0203
description	window gasket profile 1560 L 5400mm Qty 1		

door seals



Part No.	900454	Ref. No.	3108820
description	door seal profile 2510 W 447mm L 1448mm external size		
For models:	NECVM21ES2, NECVM21GS2, NECVP21ES2, NECVP21GS2		



Part No.	900451	Ref. No.	3108600
description	door seal profile 2510 W 450mm L 540mm external size Qty 1		
For models:	NECVM6ES2, NECVM6GS2, NECVP6ES2, NECVP6GS2		



Part No.	900452	Ref. No.	3108700
description	door seal profile 2510 W 450mm L 780mm external size Qty 1		
For models:	NECVM10ES2, NECVM10GS2, NECVP10ES2, NECVP10GS2		



Part No.	900453	Ref. No.	3108800
description	door seal profile 2510 W 640mm L 770mm external size Qty 1		
For models:	NECVM20ES2, NECVM20GS2, NECVP20ES2, NECVP20GS2		

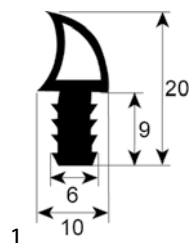

Part No.	900829	Ref. No.	2510674
description	door seal profile 2741 Qty supplied by meter		
For models:	2FX+PCF, 4FX+PCF, 74-02+2CTGG, 74-02CTEE, 74-02CTGE, 74-02CTGG, 74-02VTCEV, 76-02+4CTGG, 76-02CTGG, 76-02CTGGE		

gaskets for tray rack trolleys

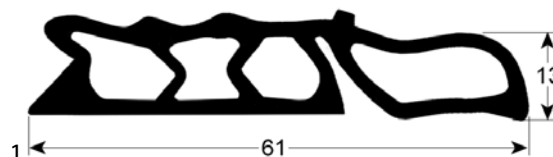

Part No.	902229	Ref. No.	51051025
description	tray rack trolley gasket profile 4090 L 615mm Qty 1		

O-rings

EPDM



Part No.	505092	Ref. No.	BN0119472130
description	O-ring EPDM thickness 5.34mm ID ø 43.82mm Qty 1 pcs		

sealing washers

fibre gaskets



Part No.	510404	Ref. No.	6A022280
description	flat gasket fibre ED ø 44mm ID ø 34mm thickness 2mm Qty 1 pcs		
For models:	74-02NPEI		

sealing cords

round



Part No.	691631	Ref. No.	6A098400
description	sealing cord round ø 16mm braided L 1m Qty 1		
For models:	2FX+PCF, 4FX+PCF, 74-02+2CTGG, 74-02CTG, 74-02CTGE, 74-02CTGG, 74-02KBGB, 74-02KBGBI, 74-02KBGMB, 74-02KBGMBI, 74-02TCTG, 76-02+4CTGG, 76-02CTG, 76-02CTGG, 76-02CTGGE, 76-02TCTGG		



springs

compression springs



Part No.	514301	Ref. No.	3107955
description	compression spring ø 6.5mm L 14mm wire gauge ø 1.2mm		
For models:	NECVM10ES2, NECVM10GS2, NECVM20ES2, NECVM20GS2, NECVM21ES2, NECVM21GS2, NECVM6ES2, NECVM6GS2, NECVP10ES2, NECVP10GS2, NECVP20ES2, NECVP20GS2, NECVP21ES2, NECVP21GS2, NECVP6ES2, NECVP6GS2		

tension springs



Part No.	691455	Ref. No.	2510545
description	tension spring ø 24.8mm total length 270mm wire gauge ø 3mm		
For models:	74-02KBGB, 74-02KBGBI, 74-02KBGMB, 74-02KBGMBI		

manometers



Part No.	541525	Ref. No.	6A022210
description	manometer ø 61mm pressure range 0 up to 1bar thread 1/4" connection on the backside		
For models:	74-02NPEI		

hose reels and spray guns

hose reels

appliance hose reels



Part No.	540662	Ref. No.	8410.1013
description	hose reel complete with spray gun hose length 1.5m		

dosing pumps

peristaltic dosing pumps

various

built-in version



Part No.	361910	Ref. No.	15985/B
description	dosing pump TECNOPRO type TP30-60-B frequency control 3l/h 230VAC rinse aid hose ø 4x6mm hose type silicone 8W		

piston pumps

dosing pumps



Part No.	361941	Ref. No.	5316075
description	dosing pump type 14825-645 230V detergent inlet 7mm outlet 9mm 0.2-0.8l/h GRI PUMPS		

membrane dosing pumps

self-priming

LANG



Part No.	361009	Ref. No.	3086077 5315665
description	dosing pump type N6 membrane dosing pump rinse aid p min 0.5bar pressure connection ø straight, 4x6mm suction connection ø straight, 4x6mm LANG		
spare parts for	361009		
	Part No.	361079	Ref. No. —
	spring for type N5/N6 for ball		
	Part No.	361080	Ref. No. —
	O-ring EPDM thickness 2mm ID ø 16mm Qty 1 pcs		
	Part No.	361085	Ref. No. —
	O-ring EPDM thickness 2mm ID ø 8mm Qty 1 pcs		

Table continues overleaf



spare parts for		361009	
Part No.	361309	Ref. No.	—
	ball for type N5/N6		
	bracket for type N6 ball guide		
	O-ring EPDM thickness 2mm ID ø 6mm Qty 1 pcs for type N6		
	valve ring for type N6 holder for O-ring		
	sealing disc for type N6		
	non-return valve inletmm outletmm outlet ø 12.4mm L 12.7mm		

hoses

formed hoses

form L



1			
Part No.	517228	Ref. No.	A15032
description	formed hose warewashing L-shape equiv. no. 15032/A		

valves and tank inlets

ball valves

ball valves electric



1			
Part No.	401190	Ref. No.	3103590
description	ball valve inlet 3/4" IT outlet 3/4" IT IP42 230V L 68mm 50/60Hz closed off-current mode of operation electric connection cable 300mm 3.5W duty cycle 50%		
For models:	NECVP10ES2, NECVP10GS2, NECVP20ES2, NECVP20GS2, NECVP21ES2, NECVP21GS2, NECVP6ES2, NECVP6GS2		

shut-off valves

universal



1			
Part No.	540415	Ref. No.	6A022453
description	star handle connection cold total lengthmm mounting pos. shaft diameter 7x7mm ø 55mm 35 built-in depth 22mm		
For models:	74-02KBGB, 74-02KBGBI, 74-02KBGMB, 74-02KBGMBI, 74-02NPEI		



1			
Part No.	540414	Ref. No.	6A022456
description	star handle connection hot total lengthmm mounting pos. shaft diameter 7x7mm ø 55mm 35 built-in depth 22mm		
For models:	74-02NPEI		



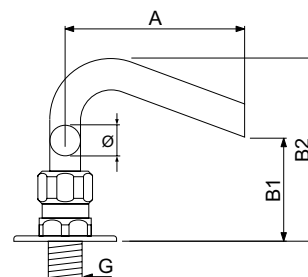

1			
Part No.	514409	Ref. No.	6A022440
description	shut-off valve connection 1/2" 1/2" straight total length 58mm mounting pos. square shaft 7x7		
For models:	74-02KBGB, 74-02KBGBI, 74-02KBGMB, 74-02KBGMBI		

inlet taps



1			
Part No.	514406	Ref. No.	6A022442
description	inlet spout connection 1/2" ET tube ø 18mm projection 105mm overall height 115mm spout height 60mm rotation 90°		
For models:	74-02KBGB, 74-02KBGBI, 74-02KBGMB, 74-02KBGMBI		



Part No.	540360	Ref. No.	6A022240
description	inlet spout connection 1/2" ET tube ø 18mm projection 105mm overall height 165mm spout height 110mm rotation 360°		
For models:	74-02NPEI		
accessories for	540360		
	Part No.	511470	Ref. No. —
	nut thread 1/2" ø 40mm H 8mm WS 25 brass Qty 1 pcs		
	Part No.	511474	Ref. No. —
	flat washer for thread 1/2"		
	Part No.	511477	Ref. No. —
	flat gasket rubber ED ø 42mm ID ø 21mm thickness 2mm Qty 1 pcs		

water cycle components

pressure reduction valves

pressure reduction valves

universal

Part No.	520271	Ref. No.	3103634
description	pressure reduction valve connection 1/2" default setting 3bar setting range 1 up to 7bar p max 20bar t.max. 80°C		
For models:	NECVM10ES2, NECVM10GS2, NECVM20ES2, NECVM20GS2, NECVM21ES2, NECVM21GS2, NECVM6ES2, NECVM6GS2		

fastening material

nuts

hexagonal nuts

DIN 934 / ISO 4032/8673

Part No.	511212	Ref. No.	11706 50BBA76598
description	hexagonal nut thread M6 H 5mm WS 10 SS DIN/ISO DIN 934 / ISO 4032/8673 Qty 1 pcs		

hexagonal nuts metric (without norm)

Part No.	101345	Ref. No.	6A010820
description	nut thread M15x1 H 3mm WS 19 brass Qty 1 pcs		
For models:	2FX+PCF, 4FX+PCF, 74-02+2CTGG, 74-02CTGG, 76-02+4CTGG, 76-02CTGG, 76-02CTGGE, 92-04CG, 92-04CG1P, 92-04CGP, 92-04TCG, 92-04TCG1P, 92-04TCGP, 94-04CG, 94-04CG1P, 94-04CGE, 94-04CGE1P, 94-04CGEP, 94-04CGG, 94-04CGG1P, 94-04CGGP, 94-04CGP, 94-04CTGE, 94-04CTGG, 94-04CTGGSS, 94-04CTGSS, 94-04TCG, 94-04TCG1P, 94-04TCGP, 94-04TCTG, 94-04TCTGSS, 96-04CG, 96-04CG2P, 96-04CGE, 96-04CGE2P, 96-04CGEE, 96-04CGEE2P, 96-04CGEEP, 96-04CGEP, 96-04CGFL, 96-04CGFL2P, 96-04CGFLP, 96-04CGG, 96-04CGG2P, 96-04CGGE, 96-04CGGE2P, 96-04CGGEP, 96-04CGGP, 96-04CGP, 96-04CTGDX...(Other models you can see in the webshop)		

consumables

cleaning agents

combi-steamer detergents/descalers

Notice: Articles labelled 'DANGEROUS GOODS' are delivered by road through a forwarder for reasons of safety and are charged separately!

Part No.	802186 ¹	Ref. No.	9006.0136
description	detergent for combi-steamer 10 litres		
description	RATIONAL Special cleaner soft for RATIONAL CleanJet and hand cleaning		

¹DANGEROUS GOODS



1

Part No.	802185 ¹	Ref. No.	9006.0137
description	rinse aid for combi-steamer 10 litres		
description			

DANGEROUS GOODS

fuses

fine fuses

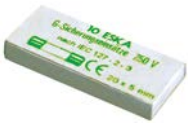

1

Part No.	358605	Ref. No.	6A001420
description	fine fuse size ø5x20mm 3.15A slow-acting rated 250V Qty 10 pcs		
For models:	94-04PEI100L, 94-04PEI150L		

fine fuse holders



1

Part No.	550848	Ref. No.	6A034500
description	fuse holder suitable fuse ø5x20mm		
For models:	NECVM10ES2, NECVM10GS2, NECVM20ES2, NECVM20GS2, NECVM21ES2, NECVM21GS2, NECVM6ES2, NECVM6GS2, NECVP10ES2, NECVP10GS2, NECVP20ES2, NECVP20GS2, NECVP21ES2, NECVP21GS2, NECVP6ES2, NECVP6GS2		

screw locks

gauge pieces (NEOZED)



1

Part No.	358066	Ref. No.	4001.1239
description	gauge piece size D02 suitable for 25A		



1

Part No.	358068	Ref. No.	4001.1241
description	gauge piece size D02 suitable for 50A		

GASTROPARTS.COM

