



**GASTROPARTS**

# Marcfi

- [EN]** Equipment
- [DE]** Geräte
- [ES]** Aparatos
- [FR]** Équipement
- [IT]** Attrezzature
- [PL]** Urządzenia
- [RU]** Оборудование

✉ [gastroparts@gastroparts.com](mailto:gastroparts@gastroparts.com)

☎ tel. +48 56 657 00 66

📘 [fb.com/gastroparts.global](https://fb.com/gastroparts.global)



**GASTROPARTS.COM**





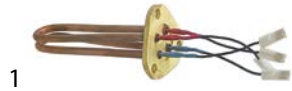

## heating elements



### heating elements for coffee machine



 <p>1</p>			
<b>Part No.</b>	417071	<b>Ref. No.</b>	N/A
<b>description</b>	heating element 1000W 230V heating circuits 2 mounting $\varnothing$ 40mm hole distance 52mm L 150mm W 40mm H 26mm hole $\varnothing$ 9mm tube $\varnothing$ 8mm immersion heater 3 hole flange suitable for Marcfi Ancas		
<b>accessories for</b>	417071		
	<b>Part No.</b>	528027	<b>Ref. No.</b> —
	gasket ID $\varnothing$ 41mm fibre thickness 2mm hole $\varnothing$ 10mm hole distance 50mm for heating element coffee machine parts		

 <p>1</p>			
<b>Part No.</b>	417069	<b>Ref. No.</b>	N/A
<b>description</b>	heating element 1100W 400V heating circuits 1 mounting $\varnothing$ 40mm hole distance 52mm L 330mm W 38mm H 56mm L1 22mm L2 40mm L3 268mm H1 30mm windings 1 hole $\varnothing$ 9mm connection cable immersion heater 3 hole flange suitable for Marcfi Ancas cable length 108mm		

 <p>1</p>			
<b>Part No.</b>	417070	<b>Ref. No.</b>	N/A
<b>description</b>	heating element 1350W 230V heating circuits 1 mounting $\varnothing$ 40mm hole distance 52mm L 334mm W 38mm H 30mm L1 20mm L2 40mm L3 270mm H2 21.5mm windings 1 hole $\varnothing$ 9mm tube $\varnothing$ 8.5mm connection cable immersion heater 3 hole flange suitable for Marcfi Ancas cable length 65mm		

 <p>1</p>			
<b>Part No.</b>	417504	<b>Ref. No.</b>	BM-2083 1
<b>description</b>	heating element 1500W 220V heating circuits 2 mounting $\varnothing$ 40mm hole distance 52mm L 150mm W 40mm H 26mm hole $\varnothing$ 9mm tube $\varnothing$ 8mm immersion heater suitable for Marcfi Ancas cable length 70mm		

 <p>1</p>			
<b>Part No.</b>	417072	<b>Ref. No.</b>	N/A
<b>description</b>	heating element 3000W 230V heating circuits 2 mounting $\varnothing$ 40mm hole distance 52mm L 355mm W 36mm H 25mm hole $\varnothing$ 9mm connection cable immersion heater 3 hole flange suitable for Marcfi Ancas cable length 105mm		
<b>accessories for</b>	417072		
	<b>Part No.</b>	528027	<b>Ref. No.</b> —
	gasket ID $\varnothing$ 41mm fibre thickness 2mm hole $\varnothing$ 10mm hole distance 50mm for heating element coffee machine parts		

 <p>1</p>			
<b>Part No.</b>	417073	<b>Ref. No.</b>	N/A
<b>description</b>	heating element 3000W 400V heating circuits 2 mounting $\varnothing$ 40mm hole distance 52mm L 339mm W 37mm H 26mm hole $\varnothing$ 8mm tube $\varnothing$ 8.5mm connection cable immersion heater 3 hole flange suitable for Marcfi Ancas cable length 80mm		
<b>accessories for</b>	417073		
	<b>Part No.</b>	528027	<b>Ref. No.</b> —
	gasket ID $\varnothing$ 41mm fibre thickness 2mm hole $\varnothing$ 10mm hole distance 50mm for heating element coffee machine parts		

 <p>1</p>			
<b>Part No.</b>	417068	<b>Ref. No.</b>	N/A
<b>description</b>	heating element 650W 230V heating circuits 1 mounting $\varnothing$ 40mm hole distance 52mm L 145mm W 34mm H 43mm L1 20mm L2 62mm L3 80mm H1 8mm H2 35mm windings 1 hole $\varnothing$ 9mm tube $\varnothing$ 8mm connection cable immersion heater 3 hole flange suitable for Marcfi Ancas cable length 100mm		

### accessories

#### sealing washers

##### PTFE gaskets

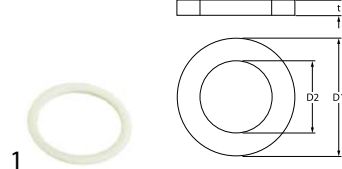
 <p>1</p>			
<b>Part No.</b>	528007	<b>Ref. No.</b>	AB-425 E
<b>description</b>	flat gasket PTFE ED $\varnothing$ 50mm ID $\varnothing$ 40mm thickness 2.5mm Qty 1 pcs		

#### flange gaskets

 <p>1</p>			
<b>Part No.</b>	528340	<b>Ref. No.</b>	TKF-5146
<b>description</b>	gasket ID $\varnothing$ 40.5mm fibre thickness 3mm hole $\varnothing$ 10mm hole distance 52mm for heating element coffee machine parts		

## switches and momentary switches

### rocker/momentary rocker switches

25.5x25mm



1

<b>Part No.</b>	347422 <sup>1</sup>	<b>Ref. No.</b>	BH-2214
<b>description</b>	rocker switch mounting measurements 25x25mm blue 2NO 250V 10A 0-1 connection male faston 6.3mm protection IP40		
<b>accessories for</b>	347422		
	<b>Part No.</b>	301323	<b>Ref. No.</b> —
<b>description</b>	protective cover external size 35x35mm H 11mm transparent suitable for rocker switch mounting measurements 25.5x25mm L 35mm W 35mm		

<sup>1</sup>illuminated

### rotary switches

GOTTAK



1

<b>Part No.</b>	346088	<b>Ref. No.</b>	N/A
<b>description</b>	rotary switch 4 0-1-2-3 400V 16A shaft round connection male faston		

## lamps

### indicator lights

indicator lights (complete)

ø 9mm



1

<b>Part No.</b>	359135	<b>Ref. No.</b>	BJ-2057
<b>description</b>	indicator light ø 9mm 230V red connection male faston 6.3mm temp.-resist. 120°C with lens		

## contactors

### LS Industrial Systems

power contactors



1

<b>Part No.</b>	380922	<b>Ref. No.</b>	BL-2029
<b>description</b>	power contactor resistive load 20A 230VAC (AC3/400V) 5A/2.2kW main contacts 3NO auxiliary contacts 1NO connection screw connection type GMC-6M		

## relays

### level relays

GICAR



1

<b>Part No.</b>	402103	<b>Ref. No.</b>	BH-2226
<b>description</b>	level controller 230/240V voltage AC 50/60Hz connection F6.3 type NRL30/1E-2C/F		

## keypads

### keypad units



1

<b>Part No.</b>	402846	<b>Ref. No.</b>	BM-2020 BM-2020G
<b>description</b>	keypad unit buttons 5 red/black suitable for Marcfi Ancas type 1d5 GRC NKP S10 lighting LED 250V L 137mm W 43mm		

1

<b>Part No.</b>	402807	<b>Ref. No.</b>	BM-2014
<b>description</b>	keypad unit buttons 5 type CONTROL d 230V		



1

<b>Part No.</b>	402809	<b>Ref. No.</b>	BM-2075
<b>description</b>	keypad unit for dosing pump buttons 5 suitable for Marcfi Ancas		

## equipment-specific units

### for espresso machines

#### filter holders

##### filter holders standard

##### filter holders long



1

<b>Part No.</b>	529153	<b>Ref. No.</b>	N/A
<b>description</b>	filter holder mounting ø 75mm hole ø 8mm outlet 3/8" ID ø 63.5mm handle M8 number of wedges 3		

#### filters

##### for 1 cup



1

<b>Part No.</b>	529100	<b>Ref. No.</b>	N/A
<b>description</b>	coffee filter ø 66.5mm mounting ø 57mm H 25mm cups 1 amount of coffee 7g		



1

<b>Part No.</b>	529098	<b>Ref. No.</b>	N/A
<b>description</b>	coffee filter ø 70mm mounting ø 60.3mm H 22mm cups 1 amount of coffee 7g		

##### for 2 cups



1

<b>Part No.</b>	529101	<b>Ref. No.</b>	N/A
<b>description</b>	coffee filter ø 67mm mounting ø 57mm H 25mm cups 2 amount of coffee 14g		



1

<b>Part No.</b>	529099	<b>Ref. No.</b>	N/A
<b>description</b>	coffee filter ø 70mm mounting ø 60.7mm H 22mm cups 2 amount of coffee 14g		

#### brewing units

##### shower screens

##### flat



1

<b>Part No.</b>	529136	<b>Ref. No.</b>	N/A
<b>description</b>	shower screen ø 51.6mm hole ø 13.1mm		



1

<b>Part No.</b>	529138	<b>Ref. No.</b>	BJ-5394
<b>description</b>	shower screen ø 54.6mm hole ø 10mm type M-920		

##### with upstand



1

<b>Part No.</b>	529140	<b>Ref. No.</b>	N/A
<b>description</b>	shower screen ø 59.5mm H 12.5mm		



## filter holder gaskets

flat

standard



1

<b>Part No.</b>	528059	<b>Ref. No.</b>	N/A
<b>description</b>	filter holder gasket D1 ø 65mm D2 ø 53mm H 5.3mm Qty 1 pcs		



1

<b>Part No.</b>	528060	<b>Ref. No.</b>	N/A
<b>description</b>	filter holder gasket D1 ø 73.5mm D2 ø 59.5mm H 7.5mm Qty 1 pcs		



1

<b>Part No.</b>	528061	<b>Ref. No.</b>	N/A
<b>description</b>	filter holder gasket D1 ø 73mm D2 ø 59mm H 8.5mm Qty 1 pcs		

## brewing units manual

components

gaskets



1

<b>Part No.</b>	526856	<b>Ref. No.</b>	E-732
<b>description</b>	gasket D1 ø 13mm ID ø 4mm thickness 4mm Viton		

components

nozzles

with thread



1

<b>Part No.</b>	526889	<b>Ref. No.</b>	F.2.003
<b>description</b>	nozzle bore ø 0.6mm thread M5 L 20mm		

screws



1

<b>Part No.</b>	531051	<b>Ref. No.</b>	BH-5921 I
<b>description</b>	screw thread M10x1.5 L 19mm thread L 6mm stainless steel Qty 1 pcs intake slotted edition until July 2002		

gaskets



1

<b>Part No.</b>	529189	<b>Ref. No.</b>	TKD-5053
<b>description</b>	group gasket L 91mm W 73mm thickness 2mm hole distance 58mm suitable for Marcfi Ancas fibre		

water dispersions

water dispersions

group 3



1

<b>Part No.</b>	531043	<b>Ref. No.</b>	BH-5920 L
<b>description</b>	water distributor ø 59mm H 13mm 10 holes hole ø 10mm brass perforation ø 1.8mm		

2-piece



1

<b>Part No.</b>	529149	<b>Ref. No.</b>	N/A
<b>description</b>	water distributor D1 ø 16mm D2 ø 13mm thread M10x1.5 hole ø 2mm perforation ø 1mm 4 holes H 13.3mm brass suitable for Marcfi Ancas		



1

<b>Part No.</b>	529128	<b>Ref. No.</b>	N/A
<b>description</b>	water distributor D1 ø 53.5mm thread M10x1.5 H 15mm brass suitable for Marcfi Ancas mounting ø 6.1mm bore ø 11mm		



drain pans

drain pans



1

<b>Part No.</b>	531039	<b>Ref. No.</b>	BM-5145
<b>description</b>	drain pan L 305mm W 110mm suitable for Marcfi Ancas		

steam/water taps

steam/water taps

components

gaskets



1

<b>Part No.</b>	526856	<b>Ref. No.</b>	E-732
<b>description</b>	gasket D1 ø 13mm ID ø 4mm thickness 4mm Viton		

steam/water pipes

steam pipes



1

<b>Part No.</b>	531036	<b>Ref. No.</b>	BM-2022
<b>description</b>	steam pipe edition until March 2005 suitable for Marcfi Ancas		



1

<b>Part No.</b>	531048	<b>Ref. No.</b>	BM-2113
<b>description</b>	steam pipe thread 3/8" ø 14mm tube ø 10mm		



1

<b>Part No.</b>	531037	<b>Ref. No.</b>	BM-2041
<b>description</b>	steam pipe thread 3/8" ø 14mm tube ø 8mm M 990, M 920 & A 93 edition until May 2006 suitable for Marcfi Ancas		

water pipes



1

<b>Part No.</b>	531049	<b>Ref. No.</b>	BM-2111
<b>description</b>	water pipe thread 3/8" ø 24mm tube ø 8mm suitable for Marcfi Ancas M 990		

fine filters

fine filters



1

<b>Part No.</b>	528788	<b>Ref. No.</b>	BM-5101
<b>description</b>	fine filter pipe ø 11mm H 10mm		

intake valves

intake valves



1

<b>Part No.</b>	531034	<b>Ref. No.</b>	BL-2011
<b>description</b>	intake valve inlet 3/8" outlet 3/8" for Marcfi Ancas		

level glasses

level glasses

level glass pipes



1

<b>Part No.</b>	529438	<b>Ref. No.</b>	N/A
<b>description</b>	water level tube ø 13mm H 113mm for M-920		

screw connections



1

<b>Part No.</b>	526891	<b>Ref. No.</b>	L120/1CR
<b>description</b>	screw connection thread M10 hole ø 3.8mm H 33mm WS 12 chrome-plated		



## knobs

### steam/water taps

### steam/water taps



1

<b>Part No.</b>	111398	<b>Ref. No.</b>	BL-3046 BM-3162
<b>description</b>	turning handle ø 39.5mm L 50mm shaft 7.5x7.5mm black		

## gaskets

### O-rings

#### EPDM

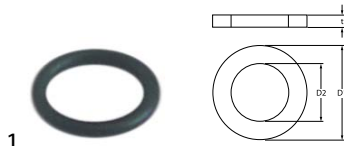

1

<b>Part No.</b>	528333	<b>Ref. No.</b>	TKF-5071
<b>description</b>	O-ring EPDM thickness 2.62mm ID ø 13.1mm Qty 1 pcs		

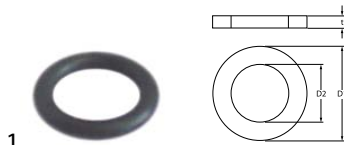

1

<b>Part No.</b>	528487	<b>Ref. No.</b>	A-266
<b>description</b>	O-ring EPDM thickness 2.62mm ID ø 9.19mm Qty 1 pcs		



1

<b>Part No.</b>	528396	<b>Ref. No.</b>	TKF-5153
<b>description</b>	O-ring EPDM thickness 2mm ID ø 7.2mm Qty 1 pcs		

#### Viton

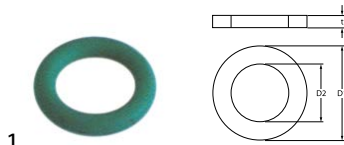

1

<b>Part No.</b>	531030	<b>Ref. No.</b>	TKF-5151 TKF-5154
<b>description</b>	O-ring Viton thickness 2.62mm ID ø 9.19mm Qty 1 pcs		

#### PTFE

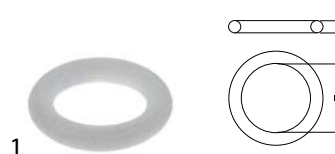

1

<b>Part No.</b>	528217	<b>Ref. No.</b>	TKF-5140
<b>description</b>	O-ring PTFE thickness 2.62mm ID ø 9.92mm Qty 1 pcs		

### sealing washers

#### aluminium gaskets



1

<b>Part No.</b>	560307	<b>Ref. No.</b>	TKA-5001
<b>description</b>	flat gasket aluminium ED ø 21mm ID ø 17mm thickness 1.5mm Qty 1 pcs		

#### PTFE gaskets



1

<b>Part No.</b>	528007	<b>Ref. No.</b>	AB-425 E
<b>description</b>	flat gasket PTFE ED ø 50mm ID ø 40mm thickness 2.5mm Qty 1 pcs		

### special gaskets

#### group gaskets



1

<b>Part No.</b>	529189	<b>Ref. No.</b>	TKD-5053
<b>description</b>	group gasket L 91mm W 73mm thickness 2mm hole distance 58mm suitable for Marcfi Ancas fibre		



1

<b>Part No.</b>	529169	<b>Ref. No.</b>	N/A
<b>description</b>	group gasket L 79.5mm W 79.5mm thickness 3mm suitable for Marcfi Ancas hole distance 55mm		







manometers

 <p>1</p>			
<b>Part No.</b>	541612	<b>Ref. No.</b>	BL-2014 BL-2015
<b>description</b>	manometer double scale ø 63mm pressure range 0-3 / 0-15bar connection on the backside thread 1/4" / 1/8" with adapter for Marcfi Ancas		

 <p>1</p>			
<b>Part No.</b>	541777	<b>Ref. No.</b>	BL-2014
<b>description</b>	manometer double scale ø 63mm pressure range 0-3 / 0-15bar connection on the backside thread 1/8"		

 <p>1</p>			
<b>Part No.</b>	541284	<b>Ref. No.</b>	N/A
<b>description</b>	manometer ø 52mm pressure range 0 up to 15bar connection on the backside marking 6/7 thread 1/4"		

 <p>1</p>			
<b>Part No.</b>	541250	<b>Ref. No.</b>	N/A
<b>description</b>	manometer ø 72mm pressure range 0 up to 3bar thread 1/4" marking 0.7-1 connection on the backside		



**GASTRO**PARTS.COM

