



GASTROPARTS

Lohberger

[EN] Equipment

[DE] Geräte

[ES] Aparatos

[FR] Équipement

[IT] Attrezzature

[PL] Urządzenia

[RU] Оборудование

✉ gastroparts@gastroparts.com

☎ +48 56 657 00 66

📘 fb.com/gastroparts.global

GASTROPARTS.COM





heating elements

heating elements for ovens

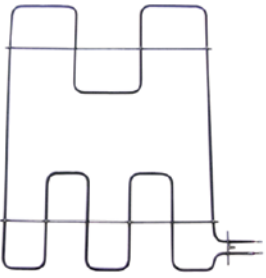

1

Part No.	415223	Ref. No.	51440360
description	heating element 2500W 400V L 450mm W 570mm L1 20mm L2 430mm W1 500mm W2 30mm flange length 70mm flange width 18mm hole distance 56mm hole \varnothing 3mm tube \varnothing 6.5mm connection length 23mm connection male faston 6.3mm heating circuits 1 rectangular flange dry heating element		
accessories for	415223		
	Part No.	510368	Ref. No. —
	gasket L 70mm W 23.5mm hole \varnothing 5mm hole distance 56mm FIBER thickness 2mm for heating element		

heating elements for bain maries



1

Part No.	415224	Ref. No.	51440350
description	heating element 1200W 400V heating circuits 1 L 280mm W 96mm flange length 45mm flange width 17mm hole distance 35mm tube \varnothing 6.3mm cable length 250mm rectangular flange hole \varnothing 5mm dry heating element L1 15mm L2 265mm W1 71mm W2 25mm		

heating elements for fryers



1

Part No.	417621	Ref. No.	FF211060
description	heating element 7500W 230V heating circuits 3 L 345mm W 126mm H 320mm rectangular flange fryer cable lengthmm tube \varnothing 8.5mm		

heating elements for large hobs



1

Part No.	418704	Ref. No.	N/A
description	heating element 1160W 400V L 255mm W 240mm H 75mm tube \varnothing 6.5mm mounting pos. inner connection screw INCOLOY		

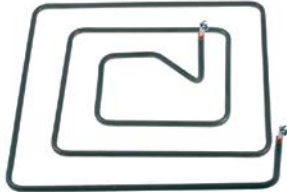

1

Part No.	418705	Ref. No.	N/A
description	heating element 1335W 400V L 270mm W 270mm H 75mm tube \varnothing 6.5mm mounting pos. centre connection screw INCOLOY		



1

Part No.	418706	Ref. No.	—
description	heating element 1505W 400V L 300mm W 300mm H 75mm tube \varnothing 6.5mm mounting pos. outer connection screw INCOLOY		

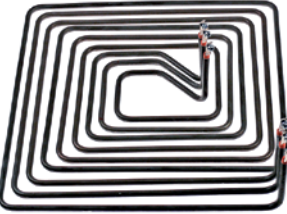

1

Part No.	418703	Ref. No.	51440405
description	heating element 4000W 400V L 300mm W 300mm H 75mm heating circuits 3 tube \varnothing 6.5mm connection screw		

heating elements for refrigeration

heating elements for defrosting



1

Part No.	419208	Ref. No.	1666250 PO1666250
description	heating element 250W 230V L 420mm W 50mm Hmm cable length 360mm tube \varnothing 6mm refrigerator connection F6.3		



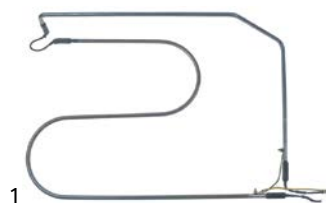

Part No.	416376	Ref. No.	1666320 PO1666320
description	heating element 300W 230V L 430mm W 85mm connection male faston 6.3mm cable length 400mm tube ø 6.3mm defrosting H 70mm		

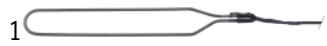

Part No.	419207	Ref. No.	1666352 PO1666352
description	heating element 350W 230V L 510mm W 340mm connection F 2.8 cable length 1000mm tube ø 8.5mm refrigerator		

heating elements for condensate evaporation



Part No.	420095	Ref. No.	1666095 PO1666095
description	heating element 95W 230V L 445mm W 60mm H 25mm cable length 4000mm tube ø 6.2mm		

heating elements for tilting bratt pan



Part No.	415208	Ref. No.	F2001128
description	heating element tilting bratt pan 2000W 230V L 641mm W 87mm H 43mm dry heating element heating circuits 1 tube ø 6.3mm L1 10mm cable length 235mm		

heating cartridges



Part No.	417227	Ref. No.	1666090 PO1666090
description	heating cartridge 90W 230V ø 12mm L 124mm thread 3/8" cable length 4000mm Hmm Wmm condensate evaporation		

pilot heating elements



Part No.	415793	Ref. No.	F7U47107
description	heating element 450W 230V heating circuits 1 L 194mm W 42mm rectangular flange hole distance 62mm hole ø 6.5mm connection M4 tube ø 6.5mm flange length 74mm flange width 63mm immersion heater		
accessories for	415793		
	Part No.	Ref. No.	F7I07004
	gasket silicone L 73mm W 62mm thickness 3mm hole ø 4mm hole distance 62/55mm for heating element		

immersion heating elements

with expansion flange 70 x 18mm



Part No.	415465	Ref. No.	F7U47139
description	heating element 3000W 230V heating circuits 2 flange 70x18mm L 365mm W 65mm connection male faston 6.3mm tube ø 8.5mm immersion heater expansion flange		
accessories for	415465		
	Part No.	Ref. No.	—
	temperature probe thermocouple K (NiCr-Ni) cable silicone probe -50 up to 1150°C cable -50 up to +180°C connection 2-wire thread probe ø1.5x100mm cable length 1.8m		

miscellaneous



Part No.	415794	Ref. No.	F7U47101
description	heating element 6000W 230V heating circuits 3 L 360mm W 35mm H 43mm tube ø 8.5mm connection M4 immersion heater rectangular flange hole distance 44mm flange length 74mm flange width 63mm hole ø 6mm		
accessories for	415794		
	Part No.	Ref. No.	F7I07004
	gasket silicone L 73mm W 62mm thickness 3mm hole ø 4mm hole distance 62/55mm for heating element		

accessories

sealing washers

O-rings

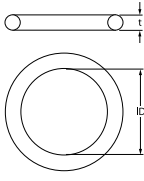
Part No.	510409	Ref. No.	H67500-118
description	O-ring EPDM thickness 5.34mm ID ø 56.52mm Qty 1 pcs		

flange gaskets

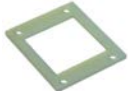

Part No.	510745	Ref. No.	F7I07004
description	gasket silicone L 73mm W 62mm thickness 3mm hole ø 4mm hole distance 62/55mm for heating element		



energy regulators

EGO

1-circuit



Part No.	380015	Ref. No.	51440126
description	energy regulator 230V 13A single-circuit turn direction right shaft ø 6x4.6mm shaft L 23mm mounting thread M4 power release 6-100% no. 50.57021.010		

thermostats

bi-metal thermostats

safety bi-metal thermostats



Part No.	390954	Ref. No.	51440146
description	bi-metal safety thermostat hole distance 23.5mm switch-off temp. 120°C 1NC 1-pole 10A 250V connection F6.3 threaded mounting ø 15mm with reset function		

control and safety thermostats

EGO

control thermostats

55.13_ series



Part No.	375925	Ref. No.	F2072039
description	thermostat t.max. 190°C 1-pole 1NO probe ø 6mm probe L 79mm capillary pipe 1830mm shaft ø 6x4.6mm shaft L 28mm		

safety thermostats

55.32_ series



Part No.	375418	Ref. No.	51440160
description	safety thermostat switch-off temp. 340°C 3-pole 20A probe ø 4mm probe L 128mm capillary pipe 1190mm capillary pipe isolatedmm gland nut probe SS		

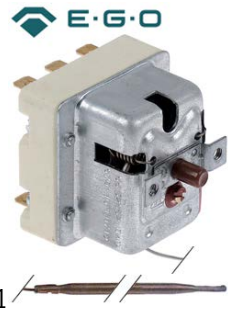

Part No.	375878	Ref. No.	51440167
description	safety thermostat switch-off temp. 570°C 3-pole probe ø 3.9mm probe L 228mm capillary pipe 890mm capillary pipe isolatedmm gland nut starting temperature 530°C		

55.33_ series



Part No.	375516	Ref. No.	F2072038
description	safety thermostat switch-off temp. 250°C 3-pole 20A probe ø 6mm probe L 107mm capillary pipe 1470mm capillary pipe isolated 1100mm gland nut M9x1 probe SS		



control thermostats with operation switch

55.13_ series

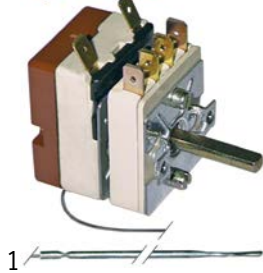

1

Part No.	375073	Ref. No.	51440140
description	thermostat t.max. 320°C temperature range 50-320°C 1-pole capillary pipe isolated gland nut		

55.34_ series

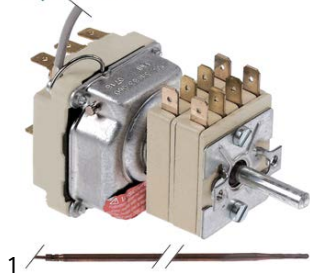

1

Part No.	375879	Ref. No.	51440191
description	thermostat t.max. 440°C temperature range 100-440°C 3-pole 3NO probe ø 3.9mm probe L 228mm capillary pipe 1110mm capillary pipe isolated 600mm gland nut rotation 270° outer switch 2NO/2NO		

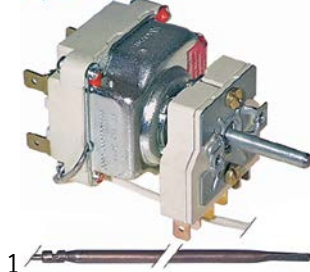

1

Part No.	375246	Ref. No.	51440169
description	thermostat t.max. 645°C temperature range 100-615/645°C 2-pole 2NO 16A probe ø 4mm probe L 230mm capillary pipe 1100mm capillary pipe isolated 600mm gland nut shaft ø 6x4.6mm shaft L 25mm shaft position lower rotation 270° outer switch 2NO probe material copper		

switches and momentary switches

rocker/momentary rocker switches

27.8x25mm



1

Part No.	348221	Ref. No.	1635110 PO1635110
description	rocker switch mounting measurements 27.8x25mm black/green 1NO/indicator light 250V 16A ON-OFF connection F6.3x0.8 ambient temperature max. 100/55°C protection IP40		

30x22mm



1

Part No.	301314	Ref. No.	1635103 PO1635103
description	rocker switch mounting measurements 30x22mm white 2NO 250V 16A ON-OFF connection male faston 6.3mm ambient temperature max. 100/55°C protection IP40		

cam switches

on/off

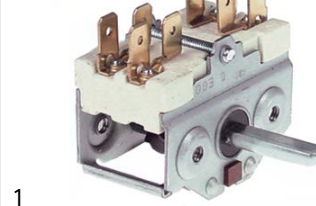

1

Part No.	300074	Ref. No.	51450150
description	cam switch 4 operating positions 2NO sequence 0-1-0-1 16A shaft ø 6x4.6mm shaft L 23mm connection male faston 6.3mm ceramic		



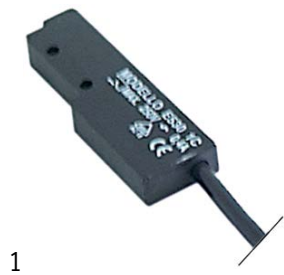

magnetic switches

65x20mm

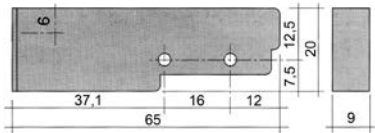

1



Part No.	345116	Ref. No.	161801 PO161801
description	magnetic switch L 65mm W 20mm 1NO 250V 0.4A P max. 100W connection cable cable length 3000mm		
accessories for	345116		
	Part No.	345399	Ref. No. —
	magnet ø 3.3mm L 40mm H 8mm W 13mm hole distance 30mm M3		

lamps

LED

indicator lamps

mounting diameter 24mm



1

Part No.	360603	Ref. No.	51460224
description	indicator light LED mounting ø 24mm 230VAC green connection male faston 2.8mm 0.4W mounting thread M24 L 59mm		



1

Part No.	360602	Ref. No.	51460223
description	indicator light LED mounting ø 24mm 230VAC yellow connection male faston 2.8mm 0.4W mounting thread M24 L 59mm		

relays

power relays

with DIN rail mounting

lateral



1

Part No.	380313	Ref. No.	166550972 PO166550972
description	power relays FINDER 230VAC 16A 3CO connection male faston DIN rail manuf. no. 62.83.8.230.0008		

electronic controllers





ELIWELL

refrigeration controllers





built-in version



1

Part No.	379570	Ref. No.	16811201 PO16811201
description	electronic controller ELIWELL type ID961 mounting measurements 71x29mm 12V voltage AC/DC NTC/PTC relay outputs 1 relay -50 up to +150°C display 3½ digits RoomTempIN yes compressor relay 8A		
accessories for	379570		
	Part No.	379053	Ref. No. —
	temperature probe PTC 1kOhm cable PVC probe -50 up to +150°C cable -10 up to 100°C probe ø6x30mm cable length 3m without screw connection 2-wire		
	Part No.	379064	Ref. No. —
	temperature probe PTC 1kOhm cable silicone probe -50 up to +150°C cable -50 up to +180°C probe ø6x40mm cable length 3m without screw connection 2-wire		
	Part No.	379161	Ref. No. —
	temperature probe NTC 10kOhm cable thermoplastic probe -40 up to +110°C cable -40 up to +110°C probe ø6x14mm cable length 3m without screw connection 2-wire		
	Part No.	379782	Ref. No. —
	temperature probe PTC 1kOhm cable thermoplastic probe -50 up to +150°C cable -40 up to +110°C probe ø6x14mm cable length 3m 2-wire resistor 1kOhm		



			
1			
Part No.	379577	Ref. No.	1681108 PO1681108
description	electronic controller ELIWELL type ID974 mounting measurements 71x29mm 230V voltage AC NTC/PTC relay outputs 3 relays -50 up to +150°C display 3½ digits RoomTempIN yes DEF Probe yes DEF Relay 8A fan relay 5A compressor relay 8A		
accessories for	379577		
	Part No.	Ref. No.	—
	379053		temperature probe PTC 1kOhm cable PVC probe -50 up to +150°C cable -10 up to 100°C probe ø6x30mm cable length 3m without screw connection 2-wire
	379064		temperature probe PTC 1kOhm cable silicone probe -50 up to +150°C cable -50 up to +180°C probe ø6x40mm cable length 3m without screw connection 2-wire
	379161		temperature probe NTC 10kOhm cable thermoplastic probe -40 up to +110°C cable -40 up to +110°C probe ø6x14mm cable length 3m without screw connection 2-wire
	379782		temperature probe PTC 1kOhm cable thermoplastic probe -50 up to +150°C cable -40 up to +110°C probe ø6x14mm cable length 3m 2-wire resistor 1kOhm

EVCO - EVERY CONTROL

refrigeration controllers

built-in version

			
1			
Part No.	378506	Ref. No.	32140974 PO32140974
description	electronic controller EVCO type EVKB23N7PXXSX01 mounting measurements 71x29mm 230V PTC/NTC -40 up to +105°C preprogrammed		

probes

universal probes

temperature probes

			
1			
Part No.	379160	Ref. No.	167212 PO167212
description	temperature probe NTC 10kOhm cable thermoplastic probe -40 up to +110°C cable -40 up to +110°C probe ø6x14mm cable length 1.5m without screw connection 2-wire		

			
1			
Part No.	379052	Ref. No.	167201 PO167201
description	temperature probe PTC 1kOhm cable silicone probe -50 up to +150°C cable -50 up to +180°C probe ø6x40mm cable length 1.5m without screw connection 2-wire		

producer-specific probes

core probes

			
1			
Part No.	401756	Ref. No.	167230 PO167230
description	core temperature probe PTC 1kOhm cable silicone probe -40 up to +120°C cable -50 up to +180°C connection 2-wire probe ø4.5x100mm thread cable length 4.5m handle ø 10mm handle length 120mm L1 150mm L2 50mm		

keypads

front foils

			
1			
Part No.	401772	Ref. No.	14261050 PO14261050
description	keypad foil blast chiller L 212mm W 102mm buttons 9 POLARIS		



compressors

ACC/ZEL

R134A

HMBP monophase

High/Medium evaporation temperature above -20/-15 °C



1

Part No.	605008	Ref. No.	141565100030 PO141565100030
description	compressor coolant R134a type GL80TB 220-240V 50Hz HMBP fully hermetic 9.5kg 1/5HP power input 554W cylinder capacity 7.6cm ³ CSIR H 175.5mm 165W 215W 290W 390W 500W 615W 727W 840W test method ASHRAE ambient temperature max. 43°C		

L'UNITE HERMETIQUE / TECUMSEH

R404A

HMBP monophase

High/Medium evaporation temperature above -20/-15 °C



1

Part No.	605023	Ref. No.	141565100040 PO141565100040
description	compressor coolant R404A type AE4450Z 220-240V 50Hz HMBP fully hermetic 12.5kg 3/8HP cylinder capacity 8.85cm ³ CSIR H 207mmWW 434W 567W 734W 927W 1270W 1367W test method EN 12900 1729W		

SECOP DANFOSS

R134A

HMBP monophase

High/Medium evaporation temperature above -20/-15 °C



1

Part No.	605089	Ref. No.	141514208850 PO141514208850
description	compressor coolant R134a type NL8.4MF 220-240V 50Hz HMBP fully hermetic 10.5kg 1/4HP cylinder capacity 8.35cm ³ RSIR/CSIR H 197mmW 235W 305W 390W 491W 610W 749W 912W test method ASHRAE		
spare parts for	605089		
	Part No.	381528	Ref. No. —
	start relay DANFOSS 117U6016 HST		

evaporation and condensing trays

condensing trays heated

universal

heating cartridges



1

Part No.	417227	Ref. No.	1666090 PO1666090
description	heating cartridge 90W 230V ø 12mm L 124mm thread 3/8" cable length 4000mm Hmm Wmm condensate evaporation		





fans

axial fans

import





1

Part No.	601080 ¹	Ref. No.	1648110155 PO1648110155
description	axial fan L 119mm W 119mm H 38mm 230VAC 50/60Hz 23/20W bearing ball bearing connection male faston 2.8mm metal ADDA fan wheel ø 110mm temp.-resist. 70°C		
accessories for	601080		
	Part No.	550898	Ref. No. —
	connecting cable cable length 2000mm connection F 2.8 connection distance 7.9mm for axial flow fan		
	Part No.	692519	Ref. No. —
	guard L 120mm W 120mm plastic		

¹with ball bearings

1

Part No.	601055 ¹	Ref. No.	1648110150 PO1648110150
description	axial fan L 92mm W 92mm H 25mm 230VAC 50/60Hz 14.5/14W bearing ball bearing connection male faston 2.8mm metal ADDA fan wheel ø 85mm temp.-resist. 70°C		
accessories for	601055		
	Part No.	550898	Ref. No. —
	connecting cable cable length 2000mm connection F 2.8 connection distance 7.9mm for axial flow fan		
	Part No.	691103	Ref. No. —
	guard ø 90mm mounting distance 83mm for axial fan 92mm		

¹with ball bearings

refrigeration fans

refrigeration motors universal

IMPORT

multi fit fan motors



1

Part No.	601022	Ref. No.	1648001015 PO1648001015
description	fan motor 10W 230V 50-60Hz L1 44mm L2 54mm L3 85mm W 84mm cable length 500mm 1300rpm YZF10-20-18/26 5 mounting options bearing slide bearing		

cross flow fans

ebm-papst



1

Part No.	601000	Ref. No.	1648106045 PO1648106045
description	cross flow fan ebm-papst QLK45/0006-2513 roller ø 45mm roller length 60mm laminated core thickness 13mm motor position left 230V/50Hz 15W refrigeration bearing rubber connection male faston 6.3mm airflow 36m³/h 0 up to +60°C		



1

Part No.	601505	Ref. No.	51470402
description	cross flow fan QLN65/2400A17-3030L roller ø 65mm roller length 240mm laminated core thickness 29mm motor position right 230V/50Hz 22W refrigeration bearing silicone connection F 6.3 0 up to +60°C 230V throughput 200m³/h 50Hz		









EMMEVI - FERGAS			
with moulded coils			
			
1			
Part No.	601110	Ref. No.	1648106018 PO1648106018
description	cross flow fan TGO 60/1-180/20 roller ø 60mm roller length 180mm laminated core thickness 20mm motor position left 230V/50Hz 28W refrigeration bearing rubber connection male faston 6.3mm -30 up to +100°C 230V cable length 1800mm		

gas taps

alternatives to EGA

GPEL21 series				
with nozzle outlet				
				
1				
Part No.	101615	Ref. No.	52110220	
description	gas tap alternatives to EGA type GPEL21D with nozzle outlet (without nozzle) gas inlet M15x1 (tube ø 10mm) external nozzle ømm internal nozzle ømm bypass nozzle ø 0.35mm mixing pipe connection M17x1 thermocouple connection M8x1 pilot connection M10x1 shaft ø 8x6.5mm shaft L 31/15mm shaft flat upper and bottom			
spare parts for	101615			
	Part No.	100408	Ref. No.	—
bypass nozzle type PEL20/21 bore ø 0.35mm thread M5x0.5				
	Part No.	101060	Ref. No.	—
magnet unit standard L 39mm D1 ø 15.4mm D2 ø 11mm suitable for PEL20-21/JUNKERS/EGA				
	Part No.	101230	Ref. No.	—
thermocouple nut T1: M8x1 T2: M18x1 aluminium				
	Part No.	101808	Ref. No.	—
gas tap front part shaft ø 8x6.5mm shaft L 31/15mm shaft flat upper and bottom suitable for PEL21				
accessories for	101615			
	Part No.	100908	Ref. No.	—
union screw thread M10x1 for pipe ø 4mm Qty 1 pcs				
	Part No.	100909	Ref. No.	—
union screw thread M10x1 for pipe ø 6mm Qty 1 pcs				
	Part No.	100926	Ref. No.	—
centring piece thread M17x1				
	Part No.	100927	Ref. No.	—
torsion spring L 2.8-8.0mm for internal nozzle ø 3mm bore ømm				

accessories for	101615			
	Part No.	100942	Ref. No.	—
union nut thread M15x1 for pipe ø 10mm				
	Part No.	100943	Ref. No.	52150025
union nut thread M17x1 tube ø 10mm				
	Part No.	101246	Ref. No.	—
olive for pipe ø 4mm Qty 1 pcs				
	Part No.	101278	Ref. No.	52150320
olive for pipe ø 10mm Qty 1 pcs				
	Part No.	101286	Ref. No.	—
olive ID ø 6mm Qty 1 pcs				
	Part No.	110217	Ref. No.	—
knob gas tap with ignition flame ø 64mm shaft ø 9x7mm shaft flat horizontal black				

STN3R

			
1			
Part No.	107335	Ref. No.	52113010 52113035
description	gas tap STN3R gas inlet pipe flange ø21mm gas outlet M17x1 (tube ø 10mm) thermocouple connection M8x1 shaft ø 6x4.6mm shaft L 25/15mm shaft flat lower with pipe outlet suitable for LOHBERGER		

ignition parts

pilot burners















JUNKERS				
CB 503 series				
pilot burners				
				
1				
Part No.	100058	Ref. No.	F2119021	
description	pilot burner JUNKERS type CB503006 natural gas nozzle no.26 gas connection 4mm			
spare parts for	100058			
	Part No.	100224	Ref. No.	—
pilot burner nozzle natural gas gas pressure 25mbar code 26 Qty 1 pcs suitable for JUNKERS CB503_				
	Part No.	101281	Ref. No.	—
olive for pipe ø 4mm L 8.7mm Qty 1 pcs suitable for CB 502/503				

Table continues overleaf



spare parts for 100058	
	Part No. 101283 Ref. No. — union screw thread M10x1 for pipe ø 4mm Qty 1 pcs
accessories for 100058	
	Part No. 100220 Ref. No. — pilot burner nozzle LPG gas pressure 50mbar code 2 Qty 1 pcs suitable for JUNKERS CB503_
	Part No. 100221 Ref. No. — pilot burner nozzle LPG gas pressure 30mbar code 29 Qty 1 pcs suitable for JUNKERS CB50203_
	Part No. 100222 Ref. No. — pilot burner nozzle LPG gas pressure 50mbar code 5 Qty 1 pcs suitable for JUNKERS CB50203_
	Part No. 100223 Ref. No. — pilot burner nozzle natural gas gas pressure 20mbar code 3 Qty 1 pcs suitable for JUNKERS CB503_
	Part No. 100226 Ref. No. — pilot burner nozzle LPG gas pressure 50mbar code 15 suitable for JUNKERS
	Part No. 100227 Ref. No. — pilot burner nozzle natural gas gas pressure 25mbar code 6 Qty 1 pcs suitable for JUNKERS CB50203_
	Part No. 100228 Ref. No. — pilot burner nozzle town gas gas pressure 8mbar code 4 Qty 1 pcs suitable for JUNKERS CB50203_
	Part No. 100909 Ref. No. — union screw thread M10x1 for pipe ø 6mm Qty 1 pcs
	Part No. 101287 Ref. No. — olive for pipe ø 6mm Qty 1 pcs
	Part No. 102110 Ref. No. — pilot tube copper pipe ø 4mm thickness 1mm L 3000mm
	Part No. 102111 Ref. No. — pilot tube copper pipe ø 6mm thickness 1mm L 3000mm

producer-specific pilot burners

LOHBERGER

old version



1	Part No. 102956	Ref. No. -
description pilot burner type C without nozzle		

1	
Part No. 102957	Ref. No. -
description pilot burner type D without nozzle	

1	
Part No. 102958	Ref. No. -
description pilot burner type E without nozzle	

electrodes

1	
Part No. 102965	Ref. No. 52165040
description ignition electrode connection F 2.8x0.8mm	

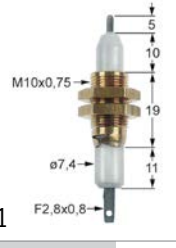
1	
Part No. 103247	Ref. No. 52152050
description ignition electrode D1 ø 7.4mm L1 5mm BL1 10mm BL2 19mm BL3 11mm connection F 2.8x0.8mm M10x0.75	

piezoelectric igniters

mounting diameter 22mm

1	
Part No. 100008	Ref. No. F2119024
description piezoelectric igniter body plastic blowing mounting ø 22mm connection ø2mm cable lengthmm	



thermocouples

threaded thermocouples

threaded thermocouples standard

with socket with thread M8x1

SIT

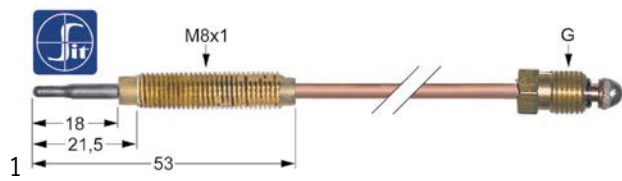

Part No.	107632	Ref. No.	52120050
description	thermocouple SIT M8x1 L 1000mm M8x1		
accessories for	107632		
	Part No.	102067	Ref. No. 52150110
	nut thread M8x1 H 3mm brass Qty 1 pcs type SEF 1		

accessories

nuts



Part No.	102067	Ref. No.	52150110
description	nut thread M8x1 H 3mm brass Qty 1 pcs type SEF 1		

gas burners

accessories

nozzle holders



Part No.	104522	Ref. No.	52165016
description	nozzle holder ID ø 10mm ET M17x1		

gas nozzles

pilot burner nozzles

pilot burner nozzles EGA





Part No.	100214	Ref. No.	52140300
description	pilot burner nozzle LPG bore ø 0.16mm Qty 1 pcs		

auxiliary gas parts



screw connections

olives



Part No.	101278	Ref. No.	52150320
description	olive for pipe ø 10mm Qty 1 pcs		
accessories for	101278		
	Part No.	100943	Ref. No. 52150025
	union nut thread M17x1 tube ø 10mm		
	Part No.	101300	Ref. No. —
	union nut thread M16x1.5 tube ø 10mm		
	Part No.	101478	Ref. No. —
	union nut thread 3/8" for pipe ø 10mm		



Part No.	101284	Ref. No.	52150310
description	olive for pipe ø 4mm Qty 1 pcs		
accessories for	101284		
	Part No.	101259	Ref. No. —
	union nut thread M8x1 for pipe ø 4mm		
	Part No.	101285	Ref. No. 52150210
	union screw thread M8x1 for pipe ø 4mm Qty 1 pcs JUNKERS		
	Part No.	101294	Ref. No. —
	union nut thread M10x1 for pipe ø 4mm WS 14 L 12mm Qty 1 pcs		

union nuts



Part No.	100943	Ref. No.	52150025
description	union nut thread M17x1 tube ø 10mm		
accessories for	100943		
	Part No.	101278	Ref. No. 52150320
	olive for pipe ø 10mm Qty 1 pcs		



union screws



1

Part No.	101285	Ref. No.	52150210
description	union screw thread M8x1 for pipe ø 4mm Qty 1 pcs JUNKERS		
accessories for	101285		
	Part No.	101284	Ref. No. 52150310
	olive for pipe ø 4mm Qty 1 pcs		

equipment-specific units

for espresso machines

brewing units

filter holder gaskets

O-rings



1

Part No.	510409	Ref. No.	H67500-118
description	O-ring EPDM thickness 5.34mm ID ø 56.52mm Qty 1 pcs		

locks

locking devices

producer-specific

LOHBERGER



1

Part No.	690462	Ref. No.	1483001 1483003 PO1483001 PO1483003
description	key cylinder ø 23mm thread M19x1 mounting measurements 16.5x19mm hub 38-45mm shaft ø 11mm thread L 12mm		
spare parts for	690462		
	Part No.	691589	Ref. No. —
	spare keys for key cylinder 690462 key number 9233		



1

Part No.	690637	Ref. No.	14830061 PO14830061
description	key cylinder with slide latch ø 23mm thread M19x1 mounting measurements 16.5x19mm hub 38-45mm shaft ø 11mm thread L 24mm		

hinges

spring assisted hinges

universal

CAFF/FERMOD

group 2



1

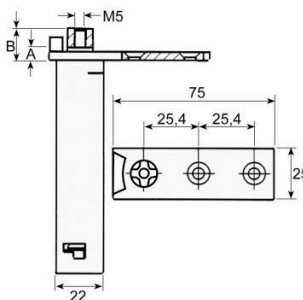

Part No.	690494	Ref. No.	1412001 PO1412001
description	spring assisted hinge series 175 mounting pos. left/right torx L 75mm W 25.6mm H 100mm A 4mm B 11mm mounting measurements 22x22mm intake torx refrigeration units mounting distance 25mm		



INTERKLIMAT

hinges



1

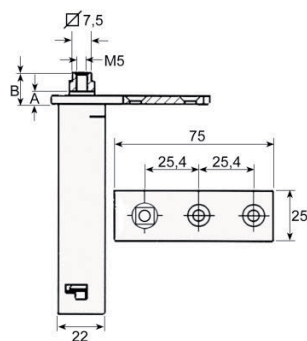

Part No.	690622	Ref. No.	1412050 PO1412050
description	spring assisted hinge series 28L mounting pos. left/right L 75mm W 25mm H 103mm A 13mm B 18mm mounting measurements 22x22mm intake 7.5x7.5 refrigeration units		

shelves and shelf rails

grates

universal

with upstand



1

Part No.	970807	Ref. No.	1440050530 PO1440050530
description	grate W 530mm D 500mm H 40mm plastic-coated steel wire gauge frame 8.8mm lengthwise wires gauge 4.8mm crossing wires 1 grey		



1

Part No.	970556	Ref. No.	1440065530 PO1440065530
description	grate W 530mm D 650mm GN 2/1 plastic-coated steel with hinge camp wire gauge frame 9mm lengthwise wires gauge 5mm crossing wires 2 white suitable for refrigerator		
accessories for	970556		
	Part No.	690330	Ref. No. —
	rack L 1000mm W 22mm H 4mm aperture 3x8mm hole distance 12.5mm stainless steel		

accessories for	970556		
	Part No.	690332	Ref. No. —
	shelf support L 31/28mm W 22mm H 17mm SS with hook Qty 1 pcs		
	Part No.	694700	Ref. No. —
	shelf support L 31/28mm W 22mm H 18mm SS Qty 12 pcs		
	Part No.	694701	Ref. No. —
	shelf support L 31/28mm W 22mm H 17mm SS with hook Qty 12 pcs		

producer-specific



1

Part No.	970662	Ref. No.	1440055535 PO1440055535
description	grate W 530mm D 550mm with layer RILSAN		

grid attachments



1

Part No.	970661	Ref. No.	33510070 PO33510070
description	bearing rail L 600mm H 34.2mm W 17mm		

shelf rails and supports

producer-specific

1

Part No.	700846	Ref. No.	3351300030 PO3351300030
description	pair of setting bar U-shape L 540mm W 30mm		

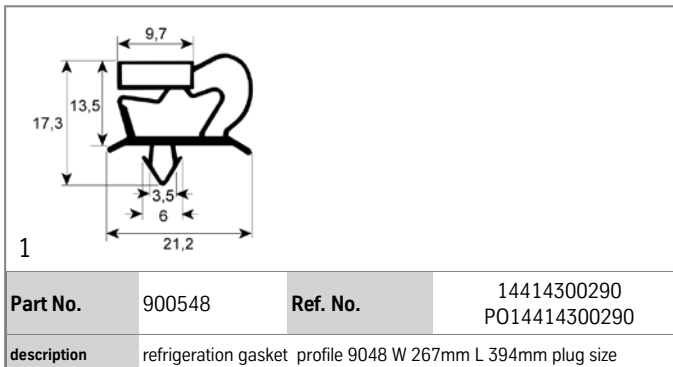
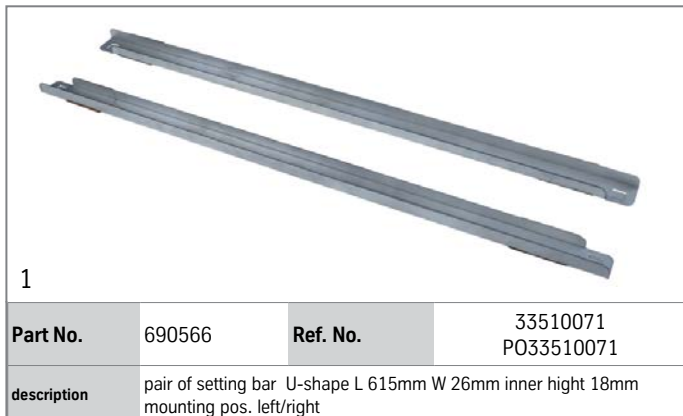

gaskets

refrigeration gaskets

plug-in gaskets

profile 9048

We offer custom-made gaskets for this profile

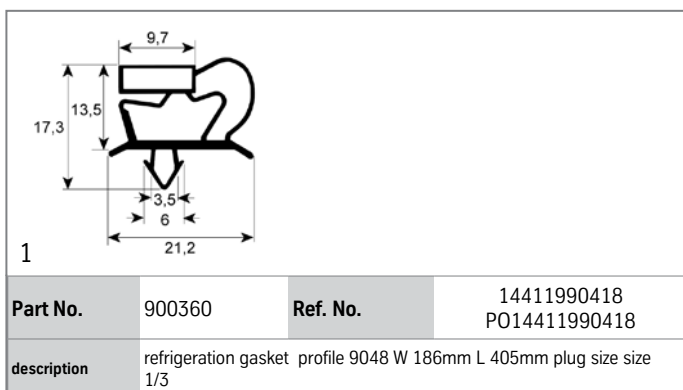
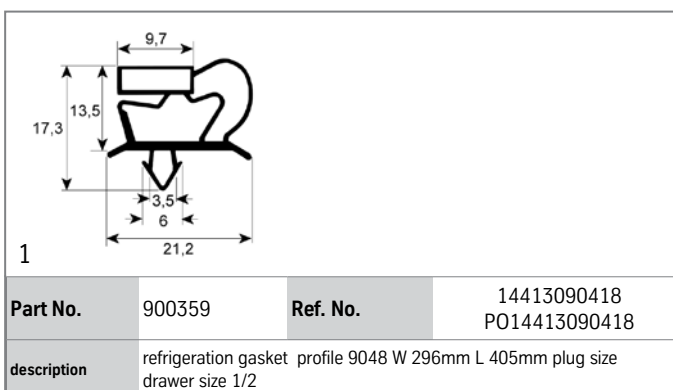
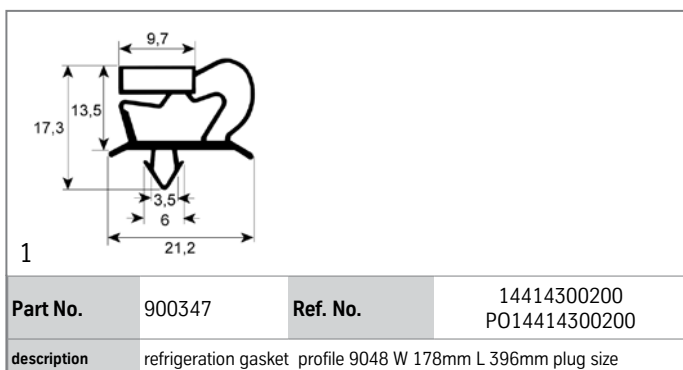
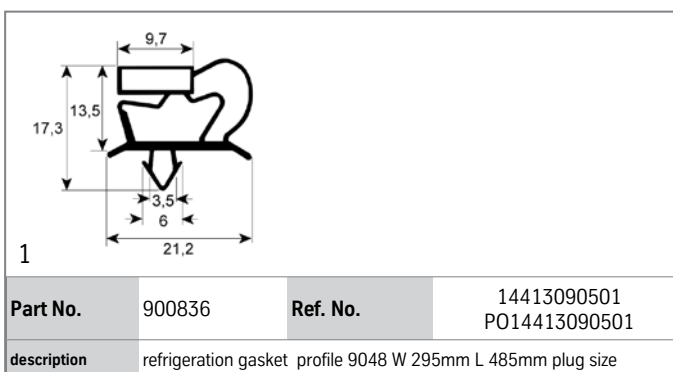
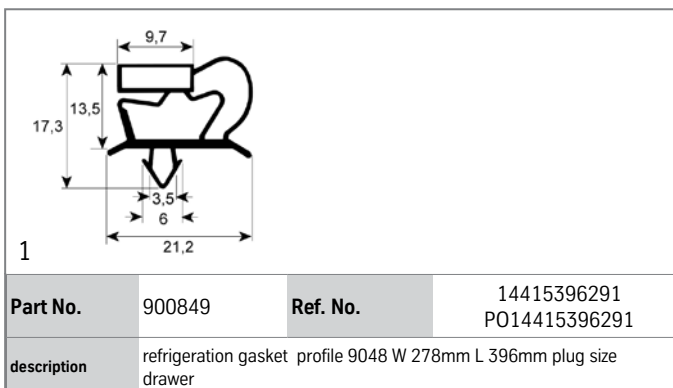
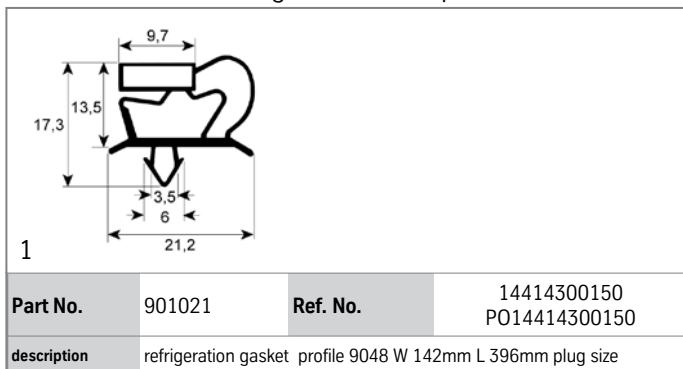



1

Part No.	901778	Ref. No.	14412950408 PO14412950408
description	refrigeration gasket profile 9048 W 300mm L 410mm plug size		

1

Part No.	901020	Ref. No.	14414020516 PO14414020516
description	refrigeration gasket profile 9048 W 402mm L 516mm plug size		

1

Part No.	900831	Ref. No.	14414300390 PO14414300390
description	refrigeration gasket profile 9048 W 354mm L 396mm plug size drawer size 2/3		

1

Part No.	900358	Ref. No.	14414180418 PO14414180418
description	refrigeration gasket profile 9048 W 405mm L 405mm plug size drawer size 2/3		

1

Part No.	901234	Ref. No.	14416600390 PO14416600390
description	refrigeration gasket profile 9048 W 390mm L 660mm plug size for blast chiller		

1

Part No.	900830	Ref. No.	14414080540 PO14414080540
description	refrigeration gasket profile 9048 W 405mm L 535mm plug size door		

1

Part No.	900731	Ref. No.	14414300620 PO14414300620
description	refrigeration gasket profile 9048 W 396mm L 566mm plug size		

1

Part No.	900357	Ref. No.	14414180640 PO14414180640
description	refrigeration gasket profile 9048 W 405mm L 627mm plug size door for refrigerated counter size 1/1		



1

Part No.	901015	Ref. No.	14415601460 PO14415601460
description	refrigeration gasket profile 9048 W 560mm L 1460mm plug size		

1

Part No.	900355	Ref. No.	14416760784 PO14416760784
description	refrigeration gasket profile 9048 W 663mm L 767mm plug size		

1

Part No.	900838	Ref. No.	14416451606 PO14416451606
description	refrigeration gasket profile 9048 W 606mm L 1566mm plug size		

1

Part No.	900732	Ref. No.	14416801580 PO14416801580
description	refrigeration gasket profile 9048 W 684mm L 1584mm plug size		

1

Part No.	900839	Ref. No.	14415990738 PO14415990738
description	refrigeration gasket profile 9048 W 606mm L 744mm plug size door		

1

Part No.	900733	Ref. No.	14416800759 PO14416800759
description	refrigeration gasket profile 9048 W 684mm L 762mm plug size		

1

Part No.	900795	Ref. No.	14416451605 PO14416451605
description	refrigeration gasket profile 9048 W 645mm L 1605mm plug size door		

1

Part No.	900841	Ref. No.	14417000780 PO14417000780
description	refrigeration gasket profile 9048 W 700mm L 780mm plug size		

1

Part No.	900356	Ref. No.	14416761594 PO14416761594
description	refrigeration gasket profile 9048 W 660mm L 1580mm plug size		

1

Part No.	900837	Ref. No.	14417321850 PO14417321850
description	refrigeration gasket profile 9048 W 732mm L 1848mm plug size		



profile 9703

We offer custom-made gaskets for this profile

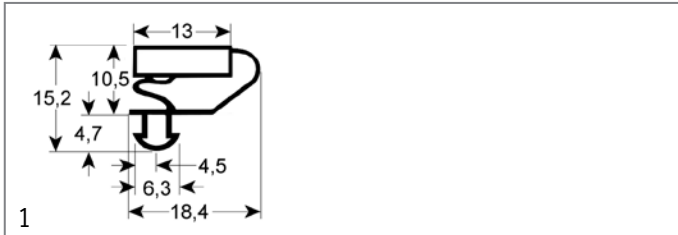

Part No.	900843	Ref. No.	14426761595 PO14426761595
description	refrigeration gasket profile 9703 W 712mm L 1610mm plug size door		

profile 9794

We offer custom-made gaskets for this profile

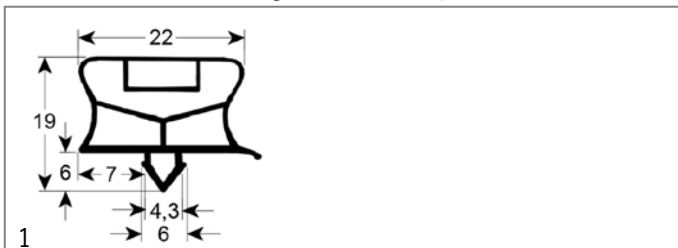

Part No.	901413	Ref. No.	14415010640 PO14415010640
description	refrigeration gasket profile 9794 W 480mm L 625mm plug size		

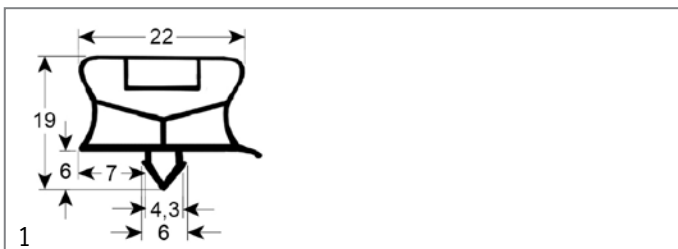

Part No.	900344	Ref. No.	14415991559 PO14415991559
description	refrigeration gasket profile 9794 W 595mm L 1565mm plug size		

gaskets for heated units

door seals

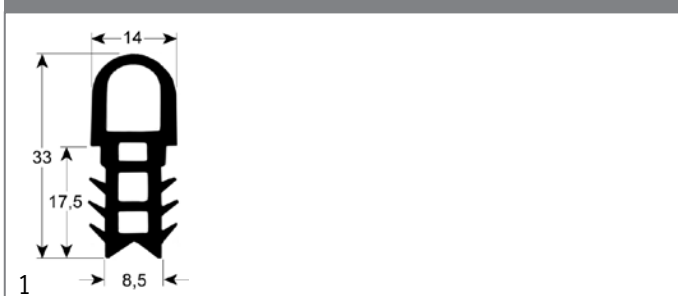

Part No.	900064	Ref. No.	F5070120
description	door seal profile 2060 W 705mm L 1080mm outer plug size Qty 1 suitable for CONVOTHERM short side open		

O-rings

EPDM

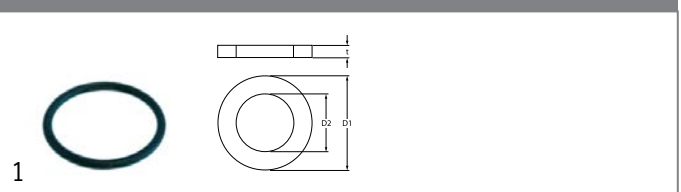

Part No.	510409	Ref. No.	H67500-118
description	O-ring EPDM thickness 5.34mm ID ø 56.52mm Qty 1 pcs		

evaporators

for fridges

producer-specific

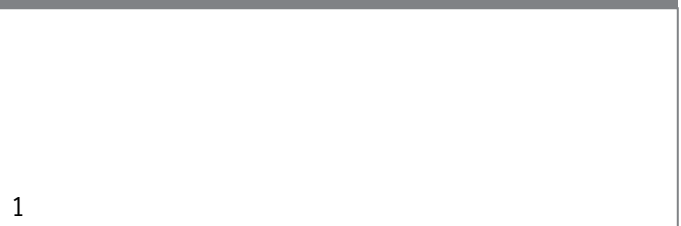

Part No.	750267	Ref. No.	14330309240 PO14330309240
description	evaporator		

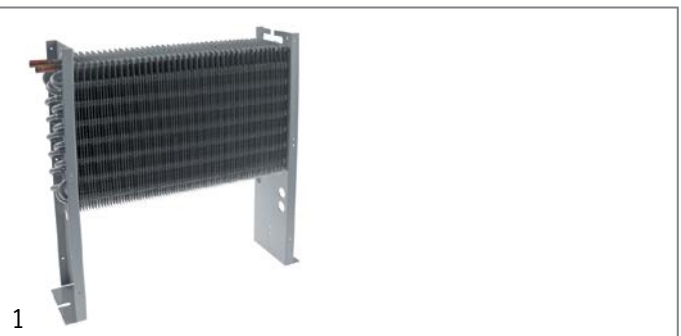

Part No.	750386	Ref. No.	14330210187 PO14330210187
description	evaporator L 350mm W 90mm H 375mm Dmm overall width 395mm connection 3/8"mm mounting distance 1 350mm		



Part No.	750269	Ref. No.	14330210186 PO14330210186
description	evaporator L 350mm W 90mm H 375mm overall width 400mm connection 3/8"mm mounting distance 1 350mm with boiler		



1

Part No.	750306	Ref. No.	14330210175 PO14330210175
description	evaporator L 380mm W 75mm H 270mm		



1

Part No.	750292	Ref. No.	14330210167 14330210168 PO14330210167 PO14330210168
description	evaporator L 400mm W 70mm H 390mm		



1

Part No.	750362	Ref. No.	1433110401 PO1433110401
description	evaporator L 435mm W 405mm H 120mm complete with fan		



1

Part No.	750268	Ref. No.	14330312410 PO14330312410
description	evaporator L 500mm W 70mm H 160mm		

hose reels and spray guns

spray guns



1

Part No.	540302	Ref. No.	20601006 VO-2060.1006	
description	spray gun for appliances 1/2" ET L 135mm type RATIONAL			
spare parts for	540302			
	Part No.	517056	Ref. No.	—
	O-ring EPDM thickness 2mm ID ø 6.5mm Qty 1 pcs			
	Part No.	532535	Ref. No.	—
	O-ring EPDM thickness 5mm ID ø 10mm Qty 1 pcs			
	Part No.	548016	Ref. No.	—
	compression spring ø 10mm L 17mm wire gauge ø 0.9mm for hand spray			
	Part No.	548017	Ref. No.	—
	pressure bolt for hand spray			

valves and tank inlets

tank inlets

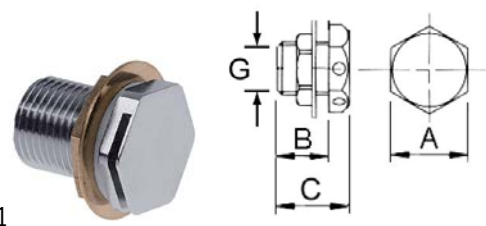

1

Part No.	691605	Ref. No.	519.10300
description	tank inlet connection 1/2" WS 27 L1 26mm L2 32mm with non-return valve		

fastening material

screws

hexagonal screws



1

Part No.	560084	Ref. No.	51272162
description	hexagonal screw thread M5 thread L 16mm SS WS 8 Qty 20 pcs DIN 933 / ISO 4017		



nuts

hexagonal nuts

hexagonal nuts metric (without norm)



1

Part No.	102067	Ref. No.	52150110
-----------------	--------	-----------------	----------

description	nut thread M8x1 H 3mm brass Qty 1 pcs type SEF 1		
--------------------	--	--	--

fasteners

slot nuts



1

Part No.	697784	Ref. No.	52423002
-----------------	--------	-----------------	----------

description	slot nut W 8mm H 7mm L 20mm		
--------------------	-----------------------------	--	--



1

Part No.	560288	Ref. No.	52423004
-----------------	--------	-----------------	----------

description	slot nut W 8mm H 7mm L 25mm		
--------------------	-----------------------------	--	--

GASTROPARTS.COM

