



**GASTROPARTS**

# LineaBlanca

- [EN]** Equipment
- [DE]** Geräte
- [ES]** Aparatos
- [FR]** Équipement
- [IT]** Attrezzature
- [PL]** Urządzenia
- [RU]** Оборудование

✉ [gastroparts@gastroparts.com](mailto:gastroparts@gastroparts.com)

☎ +48 56 657 00 66

📘 [fb.com/gastroparts.global](https://fb.com/gastroparts.global)

**GASTROPARTS.COM**





# heating elements

## immersion heating elements

### 3 hole flange ø38.5mm



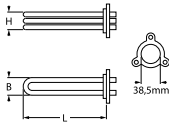

1

<b>Part No.</b>	416367	<b>Ref. No.</b>	A030019 A030019/1
<b>description</b>	heating element 2700W 230V mounting ø 38.5mm heating circuits 1 L 280mm W 26mm H 26mm tube ø 6mm hole distance 59mm hole ø 10mm 3 hole flange connection male faston 6.3mm immersion heater		
<b>accessories for</b>	416367		
	Part No.	532577	Ref. No.
	O-ring EPDM thickness 5.34mm ID ø 40.65mm Qty 1 pcs		



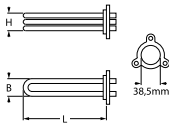

1

<b>Part No.</b>	418787	<b>Ref. No.</b>	A030020 A030020/1
<b>description</b>	heating element 3000W 230V mounting ø 38.5mm heating circuits 1 L 280mm W 25mm H 28mm tube ø 6.25mm connection male faston 6.3mm		

1

<b>Part No.</b>	418788	<b>Ref. No.</b>	A030013
<b>description</b>	heating element 4500W 230V mounting ø 38.5mm heating circuits 3 L 280mm W 30mm H 27mm number of thermostat sleeves 1 tube ø 6.25mm hole distance 59mm hole ø 10mm connection male faston 6.3mm		
<b>accessories for</b>	418788		
	Part No.	532577	Ref. No.
	O-ring EPDM thickness 5.34mm ID ø 40.65mm Qty 1 pcs		

### 3 hole flange ø47.5mm





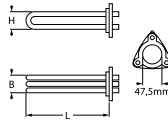

1

<b>Part No.</b>	419073	<b>Ref. No.</b>	A030017
<b>description</b>	heating element 6000W 230V mounting ø 47.5mm heating circuits 3 L 315mm W 33mm H 36mm thermostat sleeves ø 7mm length thermostat sleeves 280mm thermostat sleeve eccentric, non clinging tube ø 6.5mm connection male faston 6.3mm		
<b>accessories for</b>	419073		
	Part No.	510408	Ref. No.
	O-ring EPDM thickness 5.34mm ID ø 47mm Qty 1 pcs		

1

<b>Part No.</b>	416241	<b>Ref. No.</b>	I030007
<b>description</b>	heating element 8000W 230V mounting ø 47.5mm heating circuits 3 L 355mm W 35mm H 35mm number of thermostat sleeves 1 thermostat sleeves ø 7.5mm length thermostat sleeves 185mm thermostat sleeve not clinging tube ø 6.3mm hole distance 64mm hole ø 8mm connection M4 3 hole flange immersion heater		
<b>spare parts for</b>	416241		
	Part No.	510408	Ref. No.
	O-ring EPDM thickness 5.34mm ID ø 47mm Qty 1 pcs		
<b>accessories for</b>	416241		
	Part No.	510093	Ref. No.
	protection cap		
	Part No.	510408	Ref. No.
	O-ring EPDM thickness 5.34mm ID ø 47mm Qty 1 pcs		
	Part No.	510562	Ref. No.
	O-ring silicone thickness 5.34mm ID ø 47mm Qty 1 pcs		



### with expansion flange 70 x 18mm



1

<b>Part No.</b>	416357	<b>Ref. No.</b>	A030021
<b>description</b>	heating element 2000W 230V heating circuits 1 flange 70x18mm L 265mm W 65mm connection M4 tube ø 8.5mm		





			
1			
<b>Part No.</b>	416366	<b>Ref. No.</b>	A030022
<b>description</b>	heating element 2700W 230V heating circuits 1 flange 70x18mm L 265mm W 65mm tube ø 8.5mm connection length 32mm		
<b>accessories for</b>	416366		
	<b>Part No.</b>	510429	<b>Ref. No.</b> —
<b>description</b>	gasket L 76mm W 23mm hole distance 25mm 3 holes for heating element type DB 70 without thermostat sensor hole		
	<b>Part No.</b>	520238	<b>Ref. No.</b> —
<b>description</b>	flange L 80mm W 28mm hole distance 13mm 5 holes type DB 70 code L		

## with round flange ø47.5mm

			
1			
<b>Part No.</b>	418784	<b>Ref. No.</b>	A030014
<b>description</b>	heating element 2500W 230V heating circuits 3 mounting ø 47.5mm L 345mm W 42mm H 45mm connection male faston 6.3mm tube ø 6.5mm H1 22mm H2 23mm		

			
1			
<b>Part No.</b>	418785	<b>Ref. No.</b>	A030016
<b>description</b>	heating element 3000W 230V heating circuits 3 mounting ø 47.5mm L 345mm W 41mm H 55mm connection male faston 6.3mm tube ø 6.5mm H1 26mm H2 29mm		

			
1			
<b>Part No.</b>	418783	<b>Ref. No.</b>	A030015
<b>description</b>	heating element 5000W 230V heating circuits 3 mounting ø 47.5mm L 350mm W 41mm H 55mm connection male faston 6.3mm tube ø 6.5mm H1 28mm H2 27mm		

			
1			
<b>Part No.</b>	418789	<b>Ref. No.</b>	A030018PL A030018PLF
<b>description</b>	heating element 2000W 230V heating circuits 1 L 325mm W 85mm H 25mm L1 65mm L2 260mm W1 50mm W2 35mm thread M12x1 mounting distance 30mm tube ø 6.25mm connection length 25mm 2 hole fixing connection male faston 6.3mm immersion heater		

## accessories

## hexagonal nuts

			
1			
<b>Part No.</b>	560131	<b>Ref. No.</b>	A060001
<b>description</b>	hexagonal nut thread M4 H 3.2mm WS 7 SS DIN/ISO DIN 934 / ISO 4032/8673 Qty 20 pcs		

			
1			
<b>Part No.</b>	560132	<b>Ref. No.</b>	A060050
<b>description</b>	hexagonal nut thread M5 H 4mm WS 8 SS DIN/ISO DIN 934 / ISO 4032/8673 Qty 20 pcs		

			
1			
<b>Part No.</b>	521131	<b>Ref. No.</b>	A030403
<b>description</b>	nut thread M12x1 H 3.5mm WS 17 SS Qty 1 pcs		

## washers

			
1			
<b>Part No.</b>	560111	<b>Ref. No.</b>	A060163
<b>description</b>	plain washer ID ø 4.3mm ED ø 9mm thickness 0.8mm SS Qty 20 pcs DIN 125A for thread M4		

## sealing washers

## fibre gaskets

			
1			
<b>Part No.</b>	521110	<b>Ref. No.</b>	A030402
<b>description</b>	flat gasket fibre ED ø 20mm ID ø 13mm thickness 2mm Qty 1 pcs		

			
1			
<b>Part No.</b>	503106	<b>Ref. No.</b>	A040043
<b>description</b>	flat gasket fibre ED ø 32mm ID ø 26mm thickness 3mm Qty 1 pcs		



O-rings			
1			
<b>Part No.</b>	510408	<b>Ref. No.</b>	A040026
<b>description</b>	O-ring EPDM thickness 5.34mm ID ø 47mm Qty 1 pcs		

## thermostats

### bi-metal thermostats

#### safety bi-metal thermostats

1			
<b>Part No.</b>	390318	<b>Ref. No.</b>	A030067/1
<b>description</b>	bi-metal safety thermostat switch-off temp. 95°C 1-pole 2 hole fixing		

### control and safety thermostats

#### IMIT / TEMPOMATIC / AR THERMO

#### control thermostats

1			
<b>Part No.</b>	375921	<b>Ref. No.</b>	A030067
<b>description</b>	thermostat t.max. 90°C temperature range 30-90°C 1-pole 1CO 16A probe ø 6.5mm probe L 98mm capillary pipe 1030mm capillary pipe isolated 970mm gland nut shaft ø 6x4.6mm shaft L 18mm shaft position +135° rotation 270° probe material copper 250V		

## switches and momentary switches

### rocker/momentary rocker switches

30x22mm			
1			
<b>Part No.</b>	301003	<b>Ref. No.</b>	A030037
<b>description</b>	rocker switch mounting measurements 30x22mm green 2NO 250V 16A illuminated 0-I connection male faston 6.3mm ambient temperature max. 125/55°C protection IP65		
<b>accessories for</b>	301003		
	<b>Part No.</b>	301036	<b>Ref. No.</b>
			—
	protective cover internal size 30x22mm for rocker switch mounting measurementsmm		

1			
<b>Part No.</b>	301015	<b>Ref. No.</b>	A030041
<b>description</b>	rocker switch mounting measurements 30x22mm red 2CO 250V 16A illuminated connection male faston 6.3mm ambient temperature max. 125/55°C protection IP40		

1			
<b>Part No.</b>	346409	<b>Ref. No.</b>	A030045
<b>description</b>	momentary rocker switch mounting measurements 30x22mm yellow 2NO 250V 10A illuminated connection male faston 6.3mm ambient temperature max. 100/55°C protection IP40		
<b>accessories for</b>	346409		
	<b>Part No.</b>	301036	<b>Ref. No.</b>
			—
	protective cover internal size 30x22mm for rocker switch mounting measurementsmm		

### push/momentary push switches

#### ø25mm

1			
<b>Part No.</b>	345161 <sup>1</sup>	<b>Ref. No.</b>	A030049
<b>description</b>	push switch mounting ø 25mm green 2NO 250V 16A illuminated connection male faston 6.3mm ambient temperature max. 85°C protection IP40		

<sup>1</sup>illuminated

1			
<b>Part No.</b>	345011	<b>Ref. No.</b>	A030049C
<b>description</b>	push switch mounting ø 25mm green 2NO 250V 16A illuminated connection male faston 6.3mm ambient temperature max. 85°C protection IP65		
<b>accessories for</b>	345011		
	<b>Part No.</b>	345039	<b>Ref. No.</b>
			—
	protective cover round ED ø 33mm external size 23mm internal size 21mm H 12mm clear mounting ø 25mm		



## magnetic switches

36x13mm

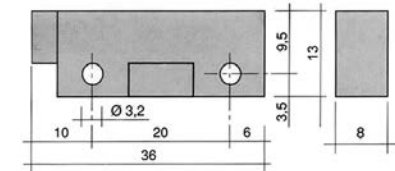
**Part No.** 345335 **Ref. No.** A030250**description** magnetic switch L 36mm W 13mm 1NO 250V 0.04A P max. 10W connection cable length 960mm**accessories for** 345335**Part No.** 519049 **Ref. No.** —  
magnet ømm L 63mm H 10.7mm W 18.8mm hole distance 52mm M2 hole ø 2mm

## accessories

## magnets

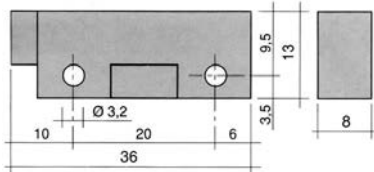
**Part No.** 345398 **Ref. No.** A030252**description** magnet ømm L 36mm H 8mm W 13mm hole distance 20mm M3 hole ø 3mm

## lamps

## indicator lights

## indicator lights (complete)

ø12mm

with plug-in socket

**Part No.** 359041 **Ref. No.** A030099**description** indicator light ø 12mm green 230V connection male faston 6.3mm temp.-resist. 120°C Qty 1 pcs

1

**Part No.** 359043 **Ref. No.** A030097**description** indicator light ø 12mm red 230V connection male faston 6.3mm temp.-resist. 120°C Qty 1 pcs

1

**Part No.** 359042 **Ref. No.** A030098**description** indicator light ø 12mm yellow 230V connection male faston 6.3mm temp.-resist. 120°C Qty 1 pcs

## ø25mm



1

**Part No.** 359204 **Ref. No.** A030074**description** indicator light ø 25mm 230V green connection male faston 6.3mm temp.-resist. 85°C**accessories for** 359204**Part No.** 345039 **Ref. No.** —  
protective cover round ED ø 33mm external size 23mm internal size 21mm H 12mm clear mounting ø 25mm

1

**Part No.** 359202 **Ref. No.** A030072**description** indicator light ø 25mm 230V red connection male faston 6.3mm

1

**Part No.** 359203 **Ref. No.** A030073**description** indicator light ø 25mm 230V yellow connection male faston 6.3mm

## 30x22mm



1

**Part No.** 359157 **Ref. No.** N/A**description** indicator light mounting measurements 30x22mm 230V green connection male faston 6.3mm temp.-resist. 125/55°C type RL2**accessories for** 359157**Part No.** 301036 **Ref. No.** —  
protective cover internal size 30x22mm for rocker switch mounting measurementsmm



			
1			
<b>Part No.</b>	359155	<b>Ref. No.</b>	A030033
<b>description</b>	indicator light mounting measurements 30x22mm 230V red connection male faston 6.3mm temp.-resist. 125°C type RL2		

			
1			
<b>Part No.</b>	346968	<b>Ref. No.</b>	A030035
<b>description</b>	indicator light mounting measurements 30x22mm 230V yellow/red connection male faston 6.3mm		

## timers

### programme timers

			
1			
<b>Part No.</b>	360433	<b>Ref. No.</b>	A030060
<b>description</b>	timer CROUZET engines 1 chambers 2 operation time 120s 230V shaft ø 6x4.6mm shaft L 20mm motor type 82340		

## contactors

### ALLEN BRADLEY

#### power contactors

			
1			
<b>Part No.</b>	380458	<b>Ref. No.</b>	A030043
<b>description</b>	power contactor resistive load 20A 230VAC (AC3/400V) 9A/4kW main contacts 3NO auxiliary contacts 1NO connection screw connection type 100-K09KF10		

			
1			
<b>Part No.</b>	381121	<b>Ref. No.</b>	A030261
<b>description</b>	power contactor resistive load 32A 230VAC (AC3/400V) 16A/7.5kW main contacts 3NO auxiliary contacts 1NO connection screw connection type 100-C16KF10		

			
1			
<b>Part No.</b>	380931	<b>Ref. No.</b>	A030260
<b>description</b>	power contactor resistive load 32A 230VAC (AC3/400V) 23A/11kW main contacts 3NO auxiliary contacts 1NO connection screw connection type 100-C23KF10		

			
1			
<b>Part No.</b>	380459	<b>Ref. No.</b>	A030042
<b>description</b>	power contactor resistive load 65A 230VAC (AC3/400V) 30A/15kW main contacts 3NO connection screw connection type 100-C30KF00 50/60Hz		

## relays

### power relays

#### with bracket mounting

			
1			
<b>Part No.</b>	380815	<b>Ref. No.</b>	A030059
<b>description</b>	power relays 230VAC 16A 2NO connection male faston 6.3mm flange dimensions 36x38x68mm		







			
1			
<b>Part No.</b>	380139	<b>Ref. No.</b>	A030063
<b>description</b>	power relays FINDER 230VAC 16A 2CO connection F6.3 bracket mounting dimensions 68x38.2x35.8mm manuf. no. 62.82.8.230.0000		



			
1			
<b>Part No.</b>	380687	<b>Ref. No.</b>	A030055
<b>description</b>	power relays FINDER 230VAC 30A 2NO connection F6.3 bracket mounting manuf. no. 66.82.8.230.0300		

## with male contacts

## female contact 4.8mm

			
1			
<b>Part No.</b>	380475	<b>Ref. No.</b>	A030056/1
<b>description</b>	power relays FINDER 220-240VAC 12A 2CO connection F4.8 raster size 10mm plug-in connection manuf. no. 56.32.8.230.0040 250V 2-pole connection 4.8mm		
<b>accessories for</b>	380475		
	<b>Part No.</b>	380476	<b>Ref. No.</b>
			—
	relay socket dimensions 78x27x33.5mm 250V voltage AC 10A FINDER manuf. no. 96.72		

## female contact 6.3mm

			
1			
<b>Part No.</b>	380866	<b>Ref. No.</b>	A030063/2
<b>description</b>	plug-in relay FINDER 230VAC 16A 2NO connection F6.3 plug-in connection manuf. no. 62.82.8.230.0309 250V connection 6.3mm		
<b>accessories for</b>	380866		
	<b>Part No.</b>	381039	<b>Ref. No.</b>
			—
	adapter for DIN rail mounting suitable for FINDER relay 62 series.		

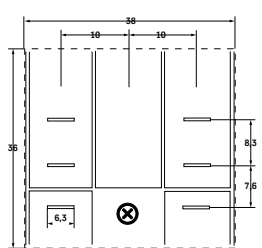

## accessories

			
1			
<b>Part No.</b>	380447	<b>Ref. No.</b>	A030057/1
<b>description</b>	adapter for DIN rail mounting suitable for FINDER relay 56.32 series.		

## solenoid valves

## solenoid valves (water)























TP			
			
1			
<b>Part No.</b>	370017	<b>Ref. No.</b>	A020030
<b>description</b>	solenoid valve single straight 230VAC inlet 3/4" outlet 11.5mm DN10 TP p max 10bar		
<b>spare parts for</b>	370017		
	<b>Part No.</b>	371013	<b>Ref. No.</b>
			—
	solenoid coil TP 230VAC 50/60Hz		
<b>accessories for</b>	370017		
	<b>Part No.</b>	371220	<b>Ref. No.</b>
			—
	reducer TP flow rate 3l/min red tolerance ±15%		
	<b>Part No.</b>	371221	<b>Ref. No.</b>
			—
	reducer TP flow rate 5.5l/min yellow tolerance ±15%		
	<b>Part No.</b>	371222	<b>Ref. No.</b>
			—
	reducer TP flow rate 6l/min grey tolerance ±15%		
	<b>Part No.</b>	371223	<b>Ref. No.</b>
			—
	reducer TP flow rate 10l/min white tolerance ±15%		
	<b>Part No.</b>	371224	<b>Ref. No.</b>
			—
	reducer TP flow rate 12l/min bronze tolerance ±15%		
	<b>Part No.</b>	371225	<b>Ref. No.</b>
			—
	reducer TP flow rate 16l/min light brown tolerance ±15%		
	<b>Part No.</b>	371226	<b>Ref. No.</b>
			—
	reducer TP flow rate 20l/min red tolerance ±15%		
	<b>Part No.</b>	371230	<b>Ref. No.</b>
			—
	reducer TP flow rate 0.25l/min red tolerance ±25%		
	<b>Part No.</b>	371231	<b>Ref. No.</b>
			—
	reducer TP flow rate 0.35l/min violet tolerance ±25%		

Table continues overleaf



accessories for 370017		Part No.	371232	Ref. No.	—
	reducer TP flow rate 0.5l/min orange tolerance ±25%	Part No.	371233	Ref. No.	—
	reducer TP flow rate 0.8l/min white tolerance ±25%	Part No.	371234	Ref. No.	—
	reducer TP flow rate 1l/min light blue tolerance ±25%	Part No.	371235	Ref. No.	—
	reducer TP flow rate 1.2l/min brown tolerance ±25%	Part No.	371236	Ref. No.	—
	reducer TP flow rate 1.5l/min light brown tolerance ±25%	Part No.	371237	Ref. No.	—
	reducer TP flow rate 2.5l/min yellow tolerance ±25%	Part No.	371238	Ref. No.	—
	reducer TP flow rate 3.4l/min dark green tolerance ±25%	Part No.	371239	Ref. No.	—
	reducer TP flow rate 5l/min black tolerance ±25%	Part No.	371240	Ref. No.	—
	reducer TP flow rate 8l/min blue tolerance ±20%				

	1		
<b>Part No.</b>	370409	<b>Ref. No.</b>	A029020
<b>description</b>	solenoid valve single straight 230VAC inlet 3/4" outlet 11.5mm output 3.4l/min t.max. 90°C TP plastic flow regulating valve outlet green flow regulating valve inlet white		

metal			
PARKER			
spare parts and accessories			
solenoid coils			
	1		
<b>Part No.</b>	371033	<b>Ref. No.</b>	A039001 A039820
<b>description</b>	solenoid coil PARKER 230VAC 9VA coil type YB09 with cable seat ø 14mm		

solenoid valves with reducers

	1		
<b>Part No.</b>	370410	<b>Ref. No.</b>	A029024
<b>description</b>	solenoid valve double straight 230VAC inlet 3/4" input 10l/min t.max. 90°C TP plastic outlet 11.5mm output A 3.4l/min output B 3.4l/min		

pressure switches  
for warewashing

73x43mm with coded plug			
	1		
<b>Part No.</b>	541955	<b>Ref. No.</b>	A030062
<b>description</b>	pressure control pressure range 75/50mbar connection 6mm size 73x43mm pressure connection ø 5.5mm		

	1		
<b>Part No.</b>	370411	<b>Ref. No.</b>	A029021
<b>description</b>	solenoid valve double straight 230VAC inlet 3/4" t.max. 90°C TP plastic flow regulating valve inlet white outlet 11.5mm output B 3.4l/min flow regulating valve outlet B green output A w/t membrane (constantly open)		





## compressors

### L'UNITE HERMETIQUE / TECUMSEH

R404A

HMBP monophasé

High/Medium evaporation temperature above -20/-15 °C



1

<b>Part No.</b>	605025	<b>Ref. No.</b>	A029058
<b>description</b>	compressor coolant R404A type AE4430Z-FZ 220-240V 50Hz HMBP fully hermetic 10.2kg 1/4HP power input 427W cylinder capacity 5.7cm <sup>3</sup> CSIR H 186mmWW 258W 346W 441W 550W 682W 794W test method EN 12900 908W		
<b>spare parts for</b>	605025		
	<b>Part No.</b>	380061	<b>Ref. No.</b> —
	start relay MTRP0027-31 120/240V voltage AC 8A 1NO		

## fans

### refrigeration fans

refrigeration motors universal

IMPORT

multi fit fan motors



1

<b>Part No.</b>	601023	<b>Ref. No.</b>	A039204
<b>description</b>	fan motor 16W 230V 50-60Hz L1 45mm L2 61mm L3 92mm W 84mm cable length 500mm 1300rpm YZF16-25-18/26 5 mounting options bearing slide bearing		



1

<b>Part No.</b>	601020	<b>Ref. No.</b>	A039200
<b>description</b>	fan motor 5W 230V 50-60Hz L1 44mm L2 48mm L3 79mm W 84mm cable length 500mm 1300rpm YZF5-13-18/26 5 mounting options bearing slide bearing		

### accessories

#### fan wheels

#### aluminium

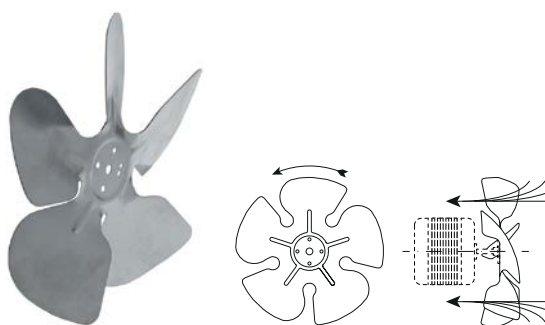

1

<b>Part No.</b>	601070	<b>Ref. No.</b>	A039211
<b>description</b>	fan wheel sucking ø 200mm fan wheel mounting 25.4mm blade angle 28° W 38mm aluminium		

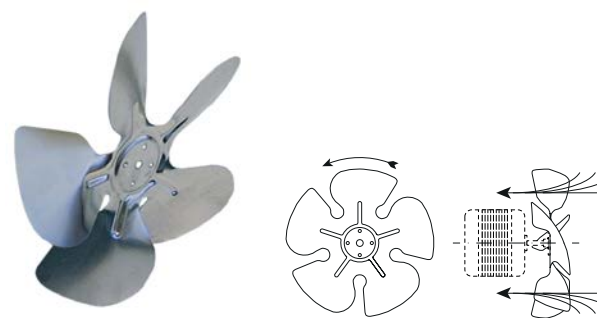

1

<b>Part No.</b>	601072	<b>Ref. No.</b>	A039210
<b>description</b>	fan wheel sucking ø 250mm fan wheel mounting 25.4mm blade angle 25° W 50mm aluminium		

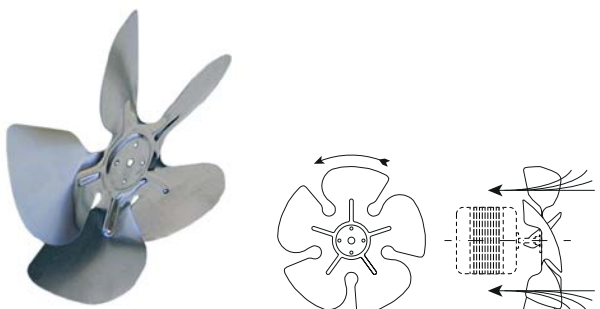
1

<b>Part No.</b>	601073	<b>Ref. No.</b>	A039212
<b>description</b>	fan wheel sucking ø 300mm fan wheel mounting 25.4mm blade angle 22° W 41mm aluminium		

## pumps

### wash and rinse pumps

#### FIR

#### pumps





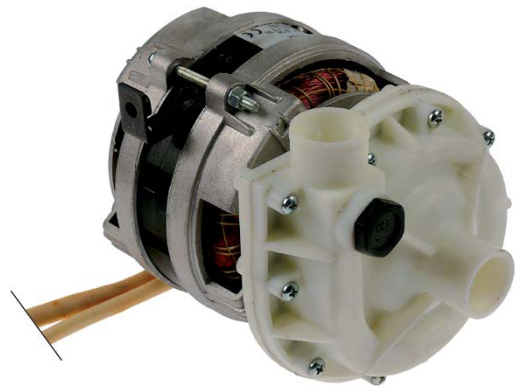

1

<b>Part No.</b>	500685	<b>Ref. No.</b>	A020006 A020006/A
<b>description</b>	pump inlet ø 28mm outlet ø 26mm type 2214.1403 230V 50Hz 1 phase 0.11kW 0.15HP L 197mm rotation direction right capacitor 6.3µF FIR		
<b>spare parts for</b>	500685		
	<b>Part No.</b>	365012	<b>Ref. No.</b> A030304
	operating capacitor capacity 6.3µF 450V tolerance 5% 50Hz ambient temperature max. -25 to +85°C ø 30mm L 61mm M8 plastic connection male faston 6.3mm protection		
	<b>Part No.</b>	510510	<b>Ref. No.</b> —
	pump cover pump type 2212/2228/2229/2211		
	<b>Part No.</b>	510695	<b>Ref. No.</b> —
	mechanical shaft seal height counter ring 5.5mm ID ø 11mm		
	<b>Part No.</b>	521203	<b>Ref. No.</b> A020909
	impellor ø 72mm H 18mm thread M7 shaft ø 11mm shaft length 32mm blades 3		
	<b>Part No.</b>	521703	<b>Ref. No.</b> A020944
	pump cover gasket EPDM thickness 2.5mm ID ø 75mm Qty 1 pcs		



1

<b>Part No.</b>	500686	<b>Ref. No.</b>	A020001 A020001/A
<b>description</b>	pump inlet ø 30mm outlet ø 30mm type 1252.1401 230V 50Hz 1 phase 0.19kW 0.25HP L 180mm rotation direction right capacitor 10µF FIR		
<b>spare parts for</b>	500686		
	<b>Part No.</b>	365015	<b>Ref. No.</b> A030300
	operating capacitor capacity 10µF 400V tolerance 5%Hz ambient temperature max. -25 to +85°C ø 35.5mm L 59mm M8 plastic connection male faston 6.3mm protection		
	<b>Part No.</b>	510605	<b>Ref. No.</b> A020910
	impellor ø 80mm H 21mm M7L		
	<b>Part No.</b>	510702	<b>Ref. No.</b> —
	mechanical shaft seal height counter ring 5.5mm ID ø 12mm		
	<b>Part No.</b>	521571	<b>Ref. No.</b> A020900
	pump cover FIR inlet ø 30mm outlet ø 30mm turn direction right ø 128mm ID ø 100mm inner height 21mm		
	<b>Part No.</b>	521701	<b>Ref. No.</b> A020941
	pump cover gasket		

## booster pumps II

### accessories



1

<b>Part No.</b>	365015	<b>Ref. No.</b>	A030300
<b>description</b>	operating capacitor capacity 10µF 400V tolerance 5%Hz ambient temperature max. -25 to +85°C ø 35.5mm L 59mm M8 plastic connection male faston 6.3mm protection		



			
1			
<b>Part No.</b>	365012	<b>Ref. No.</b>	A030304
<b>description</b>	operating capacitor capacity 6.3µF 450V tolerance 5% 50Hz ambient temperature max. -25 to +85°C ø 30mm L 61mm M8 plastic connection male faston 6.3mm protection		

## condensators & interference suppression filters

### starting capacitors

#### starting capacitors

			
1			
<b>Part No.</b>	365059	<b>Ref. No.</b>	A039322
<b>description</b>	starting capacitor 330V duty cycle 1.7% capacity 64µF		

### operating capacitors

#### plastic

			
1			
<b>Part No.</b>	365015	<b>Ref. No.</b>	A030300
<b>description</b>	operating capacitor capacity 10µF 400V tolerance 5%Hz ambient temperature max. -25 to +85°C ø 35.5mm L 59mm M8 plastic connection male faston 6.3mm protection		

			
1			
<b>Part No.</b>	365014	<b>Ref. No.</b>	A030301
<b>description</b>	operating capacitor capacity 12.5µF 450V tolerance 5%Hz ambient temperature max. -25 to +85°C ø 35mm L 70mm M8 plastic connection male faston 6.3mm 45S.C3DS.12.5 protection		

			
1			
<b>Part No.</b>	365021	<b>Ref. No.</b>	A030305
<b>description</b>	operating capacitor capacity 16µF 425V tolerance 5% 50/60Hz ambient temperature max. -25 to +85°C ø 35mm L 73mm single M8 plastic connection male faston 6.3mm 416.10.99 protection		

			
1			
<b>Part No.</b>	365016	<b>Ref. No.</b>	A030303
<b>description</b>	operating capacitor capacity 31.5µF 400V tolerance 5%Hz ambient temperature max. -25 to +85°C ø 45mm L 95mm M8 plastic connection male faston 6.3mm protection		

			
1			
<b>Part No.</b>	365012	<b>Ref. No.</b>	A030304
<b>description</b>	operating capacitor capacity 6.3µF 450V tolerance 5% 50Hz ambient temperature max. -25 to +85°C ø 30mm L 61mm M8 plastic connection male faston 6.3mm protection		

## electric accessories

### cables

#### accessories

#### cable glands

#### threaded cable glands

#### screw connections

			
1			
<b>Part No.</b>	550971	<b>Ref. No.</b>	A030065/1
<b>description</b>	cable gland thread PG16 cable ø 14mm mounting ø 22.5mm Qty 1 pcs plastic WS 27		





			
1			
<b>Part No.</b>	550973	<b>Ref. No.</b>	A030065
<b>description</b>	cable gland thread PG21 cable ø 17mm mounting ø 28mm Qty 1 pcs plastic WS 34		

terminals

connection terminals with screw/faston connections

			
1			
<b>Part No.</b>	550278	<b>Ref. No.</b>	A030108
<b>description</b>	power terminal block 3-pole max. 40A max 400V connection ø6mm <sup>2</sup> / F6.3 temp.-resist. 150°C cross section 6mm <sup>2</sup>		

			
1			
<b>Part No.</b>	550349	<b>Ref. No.</b>	A030109
<b>description</b>	power terminal block 4-pole max. 40A max 400V connection ø6mm <sup>2</sup> / F6.3 temp.-resist. 150°C cross section 6mm <sup>2</sup>		

			
1			
<b>Part No.</b>	550411	<b>Ref. No.</b>	A030113
<b>description</b>	power terminal block 6-pole max. 40A max 450V connection ø6mm <sup>2</sup> / F6.3 temp.-resist. 150°C cross section 6mm <sup>2</sup>		

terminal boards

			
1			
<b>Part No.</b>	550413	<b>Ref. No.</b>	A030106
<b>description</b>	terminal board 3-pole thread M5 L 55mm W 36mm		

equipment-specific units

for ice-cube maker

doors

doors

			
1			
<b>Part No.</b>	695409	<b>Ref. No.</b>	A309007
<b>description</b>	door for ice-cube maker W 400mm H 250mm thickness 22mm		

			
1			
<b>Part No.</b>	695410	<b>Ref. No.</b>	A309008
<b>description</b>	door for ice-cube maker W 528mm H 260mm thickness 21mm		

			
1			
<b>Part No.</b>	695411	<b>Ref. No.</b>	A309009
<b>description</b>	door for ice-cube maker W 757mm H 260mm thickness 22mm		

curtains

accessories

holders

			
1			
<b>Part No.</b>	695405	<b>Ref. No.</b>	A709107
<b>description</b>	bracket for shaft		

			
1			
<b>Part No.</b>	695404	<b>Ref. No.</b>	A049052
<b>description</b>	curtain holder for ice maker W 340mm H 115mm		



## lamellas



1

<b>Part No.</b>	695408	<b>Ref. No.</b>	A049054
-----------------	--------	-----------------	---------

<b>description</b>	lamella for curtain W 10mm H 120mm ø 6mm
--------------------	--



1

<b>Part No.</b>	695407	<b>Ref. No.</b>	A049053
-----------------	--------	-----------------	---------

<b>description</b>	lamella for curtain W 25mm H 120mm ø 6mm
--------------------	--

## curtain rods



1

<b>Part No.</b>	695406	<b>Ref. No.</b>	A059053
-----------------	--------	-----------------	---------

<b>description</b>	curtain rod for ice-cube maker L 275mm ø 6mm
--------------------	--

## pan mechanics

## spare parts and accessories



1

<b>Part No.</b>	695394	<b>Ref. No.</b>	A049059
-----------------	--------	-----------------	---------

<b>description</b>	bracket for bearing
--------------------	---------------------



1

<b>Part No.</b>	695402	<b>Ref. No.</b>	A479050
-----------------	--------	-----------------	---------

<b>description</b>	breakwater for sump L 285mm
--------------------	-----------------------------



1

<b>Part No.</b>	695390	<b>Ref. No.</b>	A049061
-----------------	--------	-----------------	---------

<b>description</b>	paddle type A
--------------------	---------------



1

<b>Part No.</b>	695392	<b>Ref. No.</b>	A049063
-----------------	--------	-----------------	---------

<b>description</b>	spacer bush ID ø 16mm
--------------------	-----------------------

## gaskets

## miscellaneous



1

<b>Part No.</b>	695395	<b>Ref. No.</b>	A049505
-----------------	--------	-----------------	---------

<b>description</b>	gasket
--------------------	--------

## knobs

## producer-specific knobs

## LINEA BLANCA



1

<b>Part No.</b>	110145	<b>Ref. No.</b>	A030068
-----------------	--------	-----------------	---------

<b>description</b>	knob thermostat t.max. 90°C 0-90°C ø 42mm shaft ø 6x4.6mm shaft flat -45° black
--------------------	---

## pullouts

## rollers

## rollers

## accessories



1

<b>Part No.</b>	560133	<b>Ref. No.</b>	A060002
-----------------	--------	-----------------	---------

<b>description</b>	hexagonal nut thread M6 H 5mm WS 10 SS DIN/ISO DIN 934 / ISO 4032/8673 Qty 20 pcs
--------------------	---

## baskets

## warewashing baskets

## steel wire baskets square

## mix baskets



1

<b>Part No.</b>	971001 <sup>1</sup>	<b>Ref. No.</b>	A050350
-----------------	---------------------	-----------------	---------

<b>description</b>	mix basket L 350mm W 350mm H 120mm mesh type wide-meshed
--------------------	--

<sup>1</sup>wide-meshed



1 

<b>Part No.</b>	970067 <sup>1</sup>	<b>Ref. No.</b>	A050306
<b>description</b>	mix basket L 400mm W 400mm H 100mm		

<sup>1</sup>wide-meshed

plate baskets

1 

<b>Part No.</b>	970069	<b>Ref. No.</b>	A050341
<b>description</b>	plate basket L 400mm W 400mm H 110mm plates 16 plate ø 200mm		

accessories

cutlery inserts

1 

<b>Part No.</b>	976011	<b>Ref. No.</b>	A050346
<b>description</b>	cutlery insert Lmm Wmm ø 110mm H 130mm		

sliding corners

1 

<b>Part No.</b>	970001	<b>Ref. No.</b>	A040242
<b>description</b>	sliding corner wire gauge ø 5mm L 120mm W 120mm H 12mm L-shape		

plate inserts

1 

<b>Part No.</b>	970047	<b>Ref. No.</b>	A050345
<b>description</b>	plate insert L 308mm W 100mm plates 15		

## gaskets

### O-rings

#### EPDM

1 

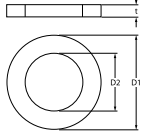

<b>Part No.</b>	528485	<b>Ref. No.</b>	A040029
<b>description</b>	O-ring EPDM thickness 1.78mm ID ø 6.07mm Qty 1 pcs		

1 

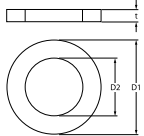

<b>Part No.</b>	530293	<b>Ref. No.</b>	A040021
<b>description</b>	O-ring EPDM thickness 1.78mm ID ø 8.73mm Qty 1 pcs		

1 

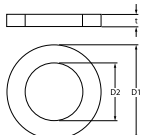

<b>Part No.</b>	361080	<b>Ref. No.</b>	A040023
<b>description</b>	O-ring EPDM thickness 2mm ID ø 16mm Qty 1 pcs		

1 

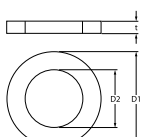

<b>Part No.</b>	510408	<b>Ref. No.</b>	A040026
<b>description</b>	O-ring EPDM thickness 5.34mm ID ø 47mm Qty 1 pcs		

### sealing washers

#### fibre gaskets

1 

<b>Part No.</b>	521110	<b>Ref. No.</b>	A030402
<b>description</b>	flat gasket fibre ED ø 20mm ID ø 13mm thickness 2mm Qty 1 pcs		

1 

<b>Part No.</b>	503106	<b>Ref. No.</b>	A040043
<b>description</b>	flat gasket fibre ED ø 32mm ID ø 26mm thickness 3mm Qty 1 pcs		





## refrigeration cycle components

## cooling water regulators

## JOHNSON CONTROLS



1

<b>Part No.</b>	541188	<b>Ref. No.</b>	A029011
<b>description</b>	cooling water regulator 3/8" type V46AA-9600 connection 7/16" UNF (1/4" SAE) pressure range 5-18bar water pressure max. 10bar water temperature max. 90°C capillary pipe 750mm L 160mm		

## evaporators

## for ice-cube maker

## for ice cube maker



1

<b>Part No.</b>	750192	<b>Ref. No.</b>	A709301
<b>description</b>	evaporator for ice-cube maker 36 cubes L 335mm W 200mm H 45mm HA/HW35-50		

## transmission technology and ball bearings

## ball bearings

## deep-groove ball bearings 2RS



1

<b>Part No.</b>	523509	<b>Ref. No.</b>	A050109
<b>description</b>	deep-groove ball bearing type 6201-2RS shaft $\varnothing$ 12mm ED $\varnothing$ 32mm W 10mm with sealing discs deep-groove ball bearing DIN 625-1		

## angular contact ball bearings



1

<b>Part No.</b>	523546	<b>Ref. No.</b>	A050108I
<b>description</b>	deep-groove ball bearing shaft $\varnothing$ 12mm ED $\varnothing$ 32mm W 15.9mm type 3201-2RS DIN 628		

## dosing pumps

## peristaltic dosing pumps

## GERMAC



## built-in version



## with frequency control



1

<b>Part No.</b>	361268	<b>Ref. No.</b>	A040067
<b>description</b>	dosing pump GERMAC frequency control 3l/h 230VAC detergent hose $\varnothing$ 4x6mm hose thermoplastic type G300 built-in version dimensions 67x72x101mm		

<b>spare parts for</b>	361268			
	<b>Part No.</b>	361467	<b>Ref. No.</b>	—
	pump hose GERMAC detergent hose type thermoplastic hose $\varnothing$ 6x10mm for model G43/G45/G53/G54/G55/G300/G305			
	<b>Part No.</b>	361557	<b>Ref. No.</b>	—
	control PCB type G300/G302/G305 GERMAC			
	<b>Part No.</b>	361589	<b>Ref. No.</b>	—
	roller assembly GERMAC suitable for G42/43/45/53/54/55/300/302/305/705			

<b>accessories for</b>	361268			
	<b>Part No.</b>	361106	<b>Ref. No.</b>	—
	container filter with weight and non-return valve SS hose $\varnothing$ 4x6mm $\varnothing$ 21mm L 51mm non return valve lip valve			
	<b>Part No.</b>	520090	<b>Ref. No.</b>	—
	PVC hose ID $\varnothing$ 4mm ED $\varnothing$ 6mm L 2m thickness 1mm t.max. 60°C transparent			
	<b>Part No.</b>	520091	<b>Ref. No.</b>	—
	nylon hose ID $\varnothing$ 4mm ED $\varnothing$ 6mm L 2m thickness 1mm operating p. 10bar burst p. 50bar t.max. 100°C transparent			



## hoses

### industrial hoses

#### extraction and pressure hoses



1

<b>Part No.</b>	530347	<b>Ref. No.</b>	A040233
<b>description</b>	universal hose ID ø 45mm ED ø 59mm L 0.5m operating p. 10bar burst p. 30bar temp.-resist. -30 up to +80°C		

## fittings, hose and pipe connectors

### hose connectors

#### without screw connection



1

<b>Part No.</b>	518347	<b>Ref. No.</b>	A040262
<b>description</b>	T-piece plastic hose ø 10-10-10mm 3-way		

## ancillary products

### clamps

#### hose clamps

##### DIN 3017 - W2



1

<b>Part No.</b>	520111	<b>Ref. No.</b>	A060170
<b>description</b>	hose clamp ø 10-16mm width 9mm Qty 10 pcs DIN 3017		



1

<b>Part No.</b>	520112	<b>Ref. No.</b>	A060171
<b>description</b>	hose clamp ø 12-20mm width 9mm Qty 10 pcs DIN 3017		



1

<b>Part No.</b>	520115	<b>Ref. No.</b>	A060172
<b>description</b>	hose clamp ø 25-40mm width 9mm Qty 10 pcs DIN 3017		



1

<b>Part No.</b>	520117	<b>Ref. No.</b>	A060173 A060174
<b>description</b>	hose clamp stainless steel ø 40-60mm width 9mm Qty 5 pcs DIN 3017		

## fastening material

### screws

#### sheet metal screws



1

<b>Part No.</b>	560108	<b>Ref. No.</b>	A060123
<b>description</b>	sheet metal screws ø 4.2mm L 13mm SS Qty 20 pcs DIN 7981/ISO 7049 head ø 8.2mm oval head		

#### countersunk screws



1

<b>Part No.</b>	560370	<b>Ref. No.</b>	A060134
<b>description</b>	countersunk screw thread M5 L 16mm stainless steel DIN 965/ISO 7046 Qty 1 pcs intake Phillips head ø 9mm		

#### flat-headed bolts



1

<b>Part No.</b>	560063	<b>Ref. No.</b>	A060081
<b>description</b>	flat-headed bolt thread M4 thread L 16mm SS DIN 7985/ISO 7045 Qty 20 pcs intake Phillips head ø 8mm head thickness 2mm		





			
1			
<b>Part No.</b>	560060	<b>Ref. No.</b>	A060078
<b>description</b>	flat-headed bolt thread M4 thread L 5mm SS DIN 7985/ISO 7045 Qty 20 pcs head ø 8mm head thickness 2mm		

## hexagonal screws

			
1			
<b>Part No.</b>	560309	<b>Ref. No.</b>	A060086
<b>description</b>	hexagonal screw thread M10 thread L 16mm SS WS 17 Qty 1 pcs DIN 933 / ISO 4017		

			
1			
<b>Part No.</b>	560311	<b>Ref. No.</b>	A060110
<b>description</b>	hexagonal screw thread M10 thread L 20mm SS WS 17 Qty 1 pcs DIN 933 / ISO 4017		

			
1			
<b>Part No.</b>	560083	<b>Ref. No.</b>	A060092
<b>description</b>	hexagonal screw thread M5 thread L 10mm SS WS 8 Qty 20 pcs DIN 933 / ISO 4017		

			
1			
<b>Part No.</b>	524423	<b>Ref. No.</b>	A060082 A060115
<b>description</b>	hexagonal screw thread M6 thread L 10mm SS WS 10 Qty 1 pcs DIN 933 / ISO 4017		

			
1			
<b>Part No.</b>	524118	<b>Ref. No.</b>	A060089 A060133
<b>description</b>	hexagonal screw thread M6 thread L 16mm SS WS 10 Qty 1 pcs DIN 933 / ISO 4017		

			
1			
<b>Part No.</b>	560089	<b>Ref. No.</b>	A060083
<b>description</b>	hexagonal screw thread M6 thread L 25mm SS WS 10 Qty 20 pcs DIN 933 / ISO 4017		

			
1			
<b>Part No.</b>	503122	<b>Ref. No.</b>	A060104
<b>description</b>	hexagonal screw thread M8 thread L 10mm SS WS 13 Qty 1 pcs DIN 933 / ISO 4017		

			
1			
<b>Part No.</b>	506447	<b>Ref. No.</b>	A060105
<b>description</b>	hexagonal screw thread M8 thread L 16mm SS WS 13 Qty 1 pcs DIN 933 / ISO 4017		

			
1			
<b>Part No.</b>	550682	<b>Ref. No.</b>	A060084
<b>description</b>	hexagonal screw thread M8 thread L 20mm SS WS 13 Qty 1 pcs DIN 933 / ISO 4017		

## cylinder head bolts

## DIN 912/ISO 4762

			
1			
<b>Part No.</b>	560033	<b>Ref. No.</b>	A060103/1
<b>description</b>	cylinder head bolt thread M6 thread L 20mm WS 5 SS Qty 20 pcs DIN 912/ISO 4762		

## grub screws

## DIN 914/ISO 4027

			
1			
<b>Part No.</b>	560457	<b>Ref. No.</b>	A060252
<b>description</b>	grub screw thread M5 L 25mm stainless steel DIN 914/ISO 4027 intake hexagonal WS 2.5 Qty 1 pcs		

			
1			
<b>Part No.</b>	697410	<b>Ref. No.</b>	A060131
<b>description</b>	grub screw thread M5 L 6mm stainless steel DIN 914/ISO 4027 WS 2.5 with spike Qty 1 pcs		



nuts

hexagonal nuts

DIN 934 / ISO 4032/8673

1 

<b>Part No.</b>	560199	<b>Ref. No.</b>	A060004
<b>description</b>	hexagonal nut thread M10 H 8mm WS 17 SS DIN/ISO DIN 934 / ISO 4032/8673 Qty 10 pcs		

1 

<b>Part No.</b>	560223	<b>Ref. No.</b>	A060019
<b>description</b>	hexagonal nut thread M3 H 2.4mm WS 5.5 SS DIN/ISO DIN 934 / ISO 4032/8673 Qty 1 pcs		

1 

<b>Part No.</b>	560340	<b>Ref. No.</b>	A060020
<b>description</b>	hexagonal nut thread M4 H 3.2mm WS 7 SS DIN/ISO DIN 934 / ISO 4032/8673 Qty 1 pcs		

1 

<b>Part No.</b>	560131	<b>Ref. No.</b>	A060001
<b>description</b>	hexagonal nut thread M4 H 3.2mm WS 7 SS DIN/ISO DIN 934 / ISO 4032/8673 Qty 20 pcs		

1 

<b>Part No.</b>	560129	<b>Ref. No.</b>	A060021
<b>description</b>	hexagonal nut thread M5 H 4mm WS 8 SS DIN/ISO DIN 934 / ISO 4032/8673 Qty 1 pcs		

1 

<b>Part No.</b>	560132	<b>Ref. No.</b>	A060050
<b>description</b>	hexagonal nut thread M5 H 4mm WS 8 SS DIN/ISO DIN 934 / ISO 4032/8673 Qty 20 pcs		

1 

<b>Part No.</b>	511212	<b>Ref. No.</b>	A060024
<b>description</b>	hexagonal nut thread M6 H 5mm WS 10 SS DIN/ISO DIN 934 / ISO 4032/8673 Qty 1 pcs		

1 

<b>Part No.</b>	560133	<b>Ref. No.</b>	A060002
<b>description</b>	hexagonal nut thread M6 H 5mm WS 10 SS DIN/ISO DIN 934 / ISO 4032/8673 Qty 20 pcs		

1 

<b>Part No.</b>	560134	<b>Ref. No.</b>	A060003 A060022
<b>description</b>	hexagonal nut thread M8 H 6.5mm WS 13 SS DIN/ISO DIN 934 / ISO 4032/8673 Qty 20 pcs		

1 

<b>Part No.</b>	560197	<b>Ref. No.</b>	A060023
<b>description</b>	nut thread M10 H 8mm WS 17 SS DIN/ISO DIN 934 / ISO 4032/8673 Qty 1 pcs		

1 

<b>Part No.</b>	506166	<b>Ref. No.</b>	A060025
<b>description</b>	nut thread M12 H 10mm WS 19 SS DIN/ISO DIN 934 / ISO 4032/8673 Qty 1 pcs		

DIN 985

1 

<b>Part No.</b>	560142	<b>Ref. No.</b>	A060024/1
<b>description</b>	hexagonal nut thread M6 H 6mm SS WS 10 Qty 20 pcs DIN/ISO DIN 985 self-locking		



## hexagonal nuts metric (without norm)



1

<b>Part No.</b>	521131	<b>Ref. No.</b>	A030403
-----------------	--------	-----------------	---------

<b>description</b>	nut thread M12x1 H 3.5mm WS 17 SS Qty 1 pcs		
--------------------	---	--	--

## washers

## spring rings



1

<b>Part No.</b>	560209	<b>Ref. No.</b>	A060155 A060156
-----------------	--------	-----------------	--------------------

<b>description</b>	lock washer ID $\varnothing$ 10.3mm ED $\varnothing$ 17.2mm SS Qty 1 pcs for thread M10		
--------------------	---	--	--



1

<b>Part No.</b>	560121	<b>Ref. No.</b>	A060165
-----------------	--------	-----------------	---------

<b>description</b>	lock washer ID $\varnothing$ 4.2mm ED $\varnothing$ 8mm SS DIN127 Qty 20 pcs for thread M4		
--------------------	--	--	--



1

<b>Part No.</b>	560123	<b>Ref. No.</b>	A060161
-----------------	--------	-----------------	---------

<b>description</b>	lock washer ID $\varnothing$ 6.3mm ED $\varnothing$ 11mm SS DIN127 Qty 20 pcs for thread M6		
--------------------	---	--	--



1

<b>Part No.</b>	560208	<b>Ref. No.</b>	A060160
-----------------	--------	-----------------	---------

<b>description</b>	lock washer ID $\varnothing$ 8.3mm ED $\varnothing$ 15mm SS Qty 1 pcs		
--------------------	---	--	--

## washers

## DIN 125A



1

<b>Part No.</b>	560111	<b>Ref. No.</b>	A060163
-----------------	--------	-----------------	---------

<b>description</b>	plain washer ID $\varnothing$ 4.3mm ED $\varnothing$ 9mm thickness 0.8mm SS Qty 20 pcs DIN 125A for thread M4		
--------------------	---	--	--

## tooth lock washers

## DIN 6798A



1

<b>Part No.</b>	560127	<b>Ref. No.</b>	A060151
-----------------	--------	-----------------	---------

<b>description</b>	tooth lock washer ID $\varnothing$ 6.2mm ED $\varnothing$ 11mm SS DIN/ISO DIN 6798A Qty 20 pcs for thread M6		
--------------------	--	--	--



1

<b>Part No.</b>	560128	<b>Ref. No.</b>	A060152
-----------------	--------	-----------------	---------

<b>description</b>	tooth lock washer ID $\varnothing$ 8.3mm ED $\varnothing$ 15mm SS DIN/ISO DIN 6798A Qty 20 pcs for thread M8		
--------------------	--	--	--

## fasteners

## clamps

## hose clamps

## DIN 3017 - W2



1

<b>Part No.</b>	520111	<b>Ref. No.</b>	A060170
-----------------	--------	-----------------	---------

<b>description</b>	hose clamp $\varnothing$ 10-16mm width 9mm Qty 10 pcs DIN 3017		
--------------------	--	--	--



1

<b>Part No.</b>	520112	<b>Ref. No.</b>	A060171
-----------------	--------	-----------------	---------

<b>description</b>	hose clamp $\varnothing$ 12-20mm width 9mm Qty 10 pcs DIN 3017		
--------------------	--	--	--





1

<b>Part No.</b>	520115	<b>Ref. No.</b>	A060172
-----------------	--------	-----------------	---------

<b>description</b>	hose clamp $\varnothing$ 25-40mm width 9mm Qty 10 pcs DIN 3017		
--------------------	--	--	--



			
1			
<b>Part No.</b>	520117	<b>Ref. No.</b>	A060173 A060174
<b>description</b>	hose clamp stainless steel ø 40-60mm width 9mm Qty 5 pcs DIN 3017		

<p>DIN 6799</p> 			
1			
<b>Part No.</b>	691470	<b>Ref. No.</b>	A060153
<b>description</b>	retaining ring E D1 ø 8mm D2 ø 16mm SS DIN 6799 thickness 1mm for shaft ø 9-12mm		

retaining rings			
DIN 471			
			
1			
<b>Part No.</b>	523107	<b>Ref. No.</b>	A060166
<b>description</b>	retaining ring shaft ø 11mm thickness 1mm SS DIN 471		



**GASTRO**PARTS.COM

