



GASTROPARTS

La-Sommeliere

- [EN]** Equipment
- [DE]** Geräte
- [ES]** Aparatos
- [FR]** Équipement
- [IT]** Attrezzature
- [PL]** Urządzenia
- [RU]** Оборудование

✉ gastroparts@gastroparts.com

☎ +48 56 657 00 66

📘 fb.com/gastroparts.global

GASTROPARTS.COM





thermostats

refrigeration thermostats

DANFOSS

service thermostats DANFOSS

All Danfoss thermostats are supplied with fastening material application:
 390552 - **fridges
 390553 - **Refrigerators with defrosting push button 390554 -
 / Refrigerators with automatic defrosting 390555 -
 absorption refrigerators
 390557 - Deep cooler with active signal
 390558 - Freezing with passive signal
 390559 - bottle cooler 390559



Part No.	390668	Ref. No.	077B0338 7038042
description	thermostat type 077B0338 capillary pipe 2000mm		

control thermostats



Part No.	390669	Ref. No.	7038257 (old version)
description	thermostat type 077B0303L capillary pipe 2000mm temperature range -8.5 up to -1°C probe ø 2mm probe Lmm DANFOSS		



Part No.	391036	Ref. No.	7038257
description	thermostat type 077B2220 capillary pipe 860mm temperature range -34 up to -15°C probe ø 2mm		

RANCO

K50 series



Part No.	390670	Ref. No.	A6004206
description	thermostat RANCO type K50-L3363 capillary pipe 2050mm probe ø9.5x130mm		

miscellaneous producers



Part No.	390671	Ref. No.	152783
description	thermostat capillary pipe 800mm		



Part No.	380869	Ref. No.	7038042
description	thermostat probe ø 3mm capillary pipe 500mm		

switches and momentary switches

push/momentary push switches

ø12mm



Part No.	346594	Ref. No.	A07025
description	momentary push switch mounting ø 12mm black 1NO 250V 4A connection male faston 6.3mm ambient temperature max. 85°C protection IP40		



lamps

LED

indicator lamps

miscellaneous



1

Part No.	700842	Ref. No.	BSF17019
description	lamp LED cable length 115mm ø 140mm		

fluorescent lamps

fluorescent lamps

G13



1

Part No.	359455	Ref. No.	Z0370019
description	fluorescent lamp socket G13 L 438mm 15W with starter		



1

Part No.	357007	Ref. No.	AM100B18 AM100B21
description	fluorescent lamp socket G13 L 895mm 30W ø 27mm 230V Qty 1 pcs		
accessories for	357007		



1

Part No.	380464	Ref. No.	AM100B19
description	starter 4-65W		



1

Part No.	401505	Ref. No.	—
description	electrical ballast 36W 230V Qty 1 pcs		



1

Part No.	402065	Ref. No.	—
description	electrical ballast 30W 230V for fluorescent lamps Qty 1 pcs		

accessories

starter



1

Part No.	380464	Ref. No.	AM100B19
description	starter 4-65W		

lamp accessories

fascias



1

Part No.	692054	Ref. No.	AM100B24
description	bezel for lighting W 1200mm H 220mm D 45mm		



1

Part No.	694235	Ref. No.	CF100009
description	cover for lamp L 1260mm W 60mm		

relays

power relays

with bracket mounting



1

Part No.	380867	Ref. No.	AM100B11
description	relay SHANGFANG 12VDC 30A 1NO connection male faston 6.3mm screw mounting at 250V 30A manuf. no. 855AW-1A-C1		

miscellaneous



1

Part No.	380868	Ref. No.	153122
description	relay 230V		



electronic controllers









SHANGFANG

refrigeration controllers

built-in version



1

Part No.	402150 ¹	Ref. No.	LG208H09
description	electronic controller SHANGFANG type SF-101S-2 mounting measurements 71x29mm 12V voltage AC NTC relay outputs 1 12VDC NTC front measurements 77x35mm built-in depth 40mm protection IP54 accuracy 1% built-in version alarm yes without accessories defr. funct. yes -45 up to +45°C display 3 digits		
spare parts for	402150		
	Part No.	379054	Ref. No. —
	transformer primary 230VAC secondary 12VAC 3VA secondary 0.25A H 40mm L 45mm W 50mm connection screw 50/60Hz type 153/M		
	Part No.	380867	Ref. No. AM100B11
	relay SHANGFANG 12VDC 30A 1NO connection male faston 6.3mm screw mounting at 250V 30A manuf. no. 855AW-1A-C1		
	Part No.	381318	Ref. No. —
	temperature probe NTC cable silicone cable colours white cable length 3m probe -40 up to +110°C cable -50 up to +180°C probe ø7x25mm coded plug		
	Part No.	381319	Ref. No. —
	temperature probe NTC cable silicone cable colours black cable length 3m evaporator probe -40 up to +110°C cable -50 up to +180°C probe ø7x25mm coded plug		
accessories for	402150		
	Part No.	379054	Ref. No. —
	transformer primary 230VAC secondary 12VAC 3VA secondary 0.25A H 40mm L 45mm W 50mm connection screw 50/60Hz type 153/M		
	Part No.	380867	Ref. No. AM100B11
	relay SHANGFANG 12VDC 30A 1NO connection male faston 6.3mm screw mounting at 250V 30A manuf. no. 855AW-1A-C1		
	Part No.	381318	Ref. No. —
	temperature probe NTC cable silicone cable colours white cable length 3m probe -40 up to +110°C cable -50 up to +180°C probe ø7x25mm coded plug		
	Part No.	381319	Ref. No. —
	temperature probe NTC cable silicone cable colours black cable length 3m evaporator probe -40 up to +110°C cable -50 up to +180°C probe ø7x25mm coded plug		

¹without relay, cable harness, probe and transformer



1

Part No.	402156	Ref. No.	CF100005
description	electronic controller SHANGFANG type SF-821 mounting measurements 71x29mm 230V voltage AC NTC relay outputs 1 NO-16A NTC front measurements 77x35mm built-in depth 60mm accuracy 1% defr. funct. yes -45 up to +100°C		

built-in version 2-piece



1

Part No.	402148 ¹	Ref. No.	AM100B10 AM33643
description	electronic controller SHANGFANG type SF-104S mounting measurements 71x29mm 230V voltage AC NTC relay outputs 2 NO-30A NO-30A NTC NTC Comp front measurements 77x35mm built-in depth 40mm protection IP54 accuracy 1% built-in version alarm incl. relay, cable harness, probe and transformer defr. funct. yes -45 up to +45°C display 3 digits		
spare parts for	402148		
	Part No.	379054	Ref. No. —
	transformer primary 230VAC secondary 12VAC 3VA secondary 0.25A H 40mm L 45mm W 50mm connection screw 50/60Hz type 153/M		
	Part No.	380867	Ref. No. AM100B11
	relay SHANGFANG 12VDC 30A 1NO connection male faston 6.3mm screw mounting at 250V 30A manuf. no. 855AW-1A-C1		
	Part No.	381318	Ref. No. —
	temperature probe NTC cable silicone cable colours white cable length 3m probe -40 up to +110°C cable -50 up to +180°C probe ø7x25mm coded plug		
	Part No.	381319	Ref. No. —
	temperature probe NTC cable silicone cable colours black cable length 3m evaporator probe -40 up to +110°C cable -50 up to +180°C probe ø7x25mm coded plug		
accessories for	402148		
	Part No.	379054	Ref. No. —
	transformer primary 230VAC secondary 12VAC 3VA secondary 0.25A H 40mm L 45mm W 50mm connection screw 50/60Hz type 153/M		
	Part No.	380867	Ref. No. AM100B11
	relay SHANGFANG 12VDC 30A 1NO connection male faston 6.3mm screw mounting at 250V 30A manuf. no. 855AW-1A-C1		
	Part No.	381318	Ref. No. —
	temperature probe NTC cable silicone cable colours white cable length 3m probe -40 up to +110°C cable -50 up to +180°C probe ø7x25mm coded plug		
	Part No.	381319	Ref. No. —
	temperature probe NTC cable silicone cable colours black cable length 3m evaporator probe -40 up to +110°C cable -50 up to +180°C probe ø7x25mm coded plug		

¹incl. relay, cable harness, probe and transformer



accessories



1

Part No.	380867	Ref. No.	AM100B11
description	relay SHANGFANG 12VDC 30A 1NO connection male faston 6.3mm screw mounting at 250V 30A manuf. no. 855AW-1A-C1		

electronics

PCBs



1

Part No.	401852	Ref. No.	CVH21021 CVH21021_BIS
description	keypad PCB refrigeration L 180mm W 42mm with display buttons 4		



1

Part No.	402151	Ref. No.	D123BP0302
description	PCB refrigerator L 100mm W 98mm suitable for CM270		



1

Part No.	401845	Ref. No.	CVH21046
description	power PCB L 235mm W 70mm suitable for MC209/CVH210 230V 15A		

compressors

EMBRACO / ASPERA

R134A

LBP monophase

Lower evaporation temperature below -20°C



1

Part No.	605119	Ref. No.	A6001206
description	compressor coolant R134a type NE2121Z 220-240V 50Hz LBP fully hermetic 11.7kg 1/4HP cylinder capacity 9.26cm ³ CSIR H 215mm 163W 217W 285W 368W 465W 575W test method EN 12900		

HBP monophase

High evaporation temperature above -15°C



1

Part No.	605115	Ref. No.	A6001256
description	compressor coolant R134a type T6217Z 220-240V 50Hz HBP fully hermetic 16.8kg 1/2HP cylinder capacity 22.4cm ³ CSIR H 225mmWWW 718W 973W 1275W 1624W 2020W 2464W test method ASHRAE		



SECOP DANFOSS

R134A

LBP monophase

Lower evaporation temperature below -20°C



1

Part No.	605052	Ref. No.	AC2PT37
description	compressor coolant R134a type TL5G 220-240V 50Hz LBP/HBP fully hermetic 7.5kg 1/6HP cylinder capacity 5.08cm ³ RSIR/CSIR H 173mm 69W 97W 132W 172W 220W 277W 345W 423W 461W test method ASHRAE		
spare parts for	605052		
	Part No.	380076	Ref. No. —
	start relay DANFOSS 117U6000 HST		

HBP monophase

High evaporation temperature above -15°C



1

Part No.	605052	Ref. No.	AC2PT37
description	compressor coolant R134a type TL5G 220-240V 50Hz LBP/HBP fully hermetic 7.5kg 1/6HP cylinder capacity 5.08cm ³ RSIR/CSIR H 173mm 69W 97W 132W 172W 220W 277W 345W 423W 461W test method ASHRAE		
spare parts for	605052		
	Part No.	380076	Ref. No. —
	start relay DANFOSS 117U6000 HST		

HMBP monophase

High/Medium evaporation temperature above -20/-15 °C



1

Part No.	605091	Ref. No.	195B0193
description	compressor coolant R134a type FR8.5G 220-240V 50Hz HMBP 10.6kg 1/4HP power input 261W cylinder capacity 7.95cm ³ RSIR/CSIR H 196mm 85W 123W 171W 228W 298W 381W 478W 592W 722WW		
spare parts for	605091		
	Part No.	380484	Ref. No. —
	start relay DANFOSS 117U6015/F394 HST		



1

Part No.	605193	Ref. No.	LG330H19
description	compressor coolant R134a type NL11MF 220-240V 50Hz HMBP 10.5kg 1/3HP cylinder capacity 11.15cm ³ RSIR/CSIR H 203mmWW 321W 418W 534W 670W 832W 1020W 1239W test method ASHRAE		
spare parts for	605193		
	Part No.	381530	Ref. No. —
	start relay DANFOSS 117U6022 HST		



1

Part No.	605087	Ref. No.	153117
description	compressor coolant R134a type SC12G 220-240V 50Hz HMBP fully hermetic 12.6kg 1/3HP power input 470W cylinder capacity 12.9cm ³ RSIR/CSIR H 203mm 140W 216W 312W 430W 574W 746W 951W 1191W 1469W test method ASHRAE 79.6W 1790W		
spare parts for	605087		
	Part No.	380483	Ref. No.
			—
	start relay DANFOSS 117U6003 HST		



1

Part No.	605118	Ref. No.	AM100B5 CF100031
description	compressor Guangzhou type AQAW91 coolant R134a 220V 50Hz		

miscellaneous

various



1

Part No.	605121	Ref. No.	BSF17026
description	compressor BAIXUE type QDH28G coolant R134a 230V 50Hz		



1

Part No.	605117	Ref. No.	BC82A11
description	compressor Guangzhou type AS30 coolant R134a 230V 50Hz		



1

Part No.	605116	Ref. No.	AM33633
description	compressor Guangzhou type AQAW77 coolant R134a 220V 50Hz		



1

Part No.	605120	Ref. No.	MB88NAEM134
description	compressor LG type MA57LAEG coolant R134a 230V 50Hz		



fans

axial fans

import



1

Part No.	601609 ¹	Ref. No.	AC2P-T15 AC2PW04
description	axial fan L 119mm W 119mm H 25mm 230VAC 50-60Hz 14W bearing ball bearing connection male faston 2.8mm input current 0.07A housing aluminium		

¹with ball bearings



1

Part No.	601604 ¹	Ref. No.	AC2PT33 AM33615 LG208H16
description	axial fan L 119mm W 119mm H 38mm 230VAC 50/60Hz 17/15W bearing slide bearing manuf. no. AA1282HS-AT connection cable 300mm fan wheel ø 110mm temp.-resist. 70°C input current 0.1A airflow 130m³/h 2600rpm		

¹with slide bearings



1

Part No.	601601 ¹	Ref. No.	SA03018
description	axial fan L 119mm W 119mm H 38mm 230VAC 50/60Hz 22W bearing slide bearing manuf. no. DP200A2123XST.GN SUNON input current 0.14A		

¹with slide bearings

1

Part No.	601606	Ref. No.	AM100B30
description	axial fan L 119mm W 119mm H 38mm 230VAC 50/60Hz bearing slide bearing set 4-piece		

refrigeration fans

refrigeration motors universal

IMPORT

multi fit fan motors



1

Part No.	601050	Ref. No.	S1000112
description	fan motor 34W 230V 50-60Hz L2 90mm L3 121mm W 84mm cable length 500mm 1300rpm YZF34-45-18/26 5 mounting options bearing slide bearing		



1

Part No.	601020	Ref. No.	A6002001
description	fan motor 5W 230V 50-60Hz L1 44mm L2 48mm L3 79mm W 84mm cable length 500mm 1300rpm YZF5-13-18/26 5 mounting options bearing slide bearing		



cooling motors (complete)



1			
Part No.	601610	Ref. No.	CF100023
description	fan 230V 5W 50/60Hz fan wheel ø 172mm shaft L 20mm W 105mm blade angle 28° connection with cable mounting distance 208mm ø 220mm		

cold air circulating fans (other)



1			
Part No.	601605	Ref. No.	A6002088
description	fan motor 230V 50-60Hz 26W shaft ø 4.5mm shaft L 42mm		

cross flow fans

EMMEVI - FER GAS

with standard coil



1			
Part No.	601018	Ref. No.	A6002035 A6002036
description	cross flow fan TG 180 roller ø 60mm roller length 180mm motor position right 230V/50Hz 25W universal bearing silicone connection male faston 6.3mm -10 up to +60°C 230V connections 1-2 1950U/min connections 1-4 1500U/min		

equipment-specific units

for fridges

bottom parts

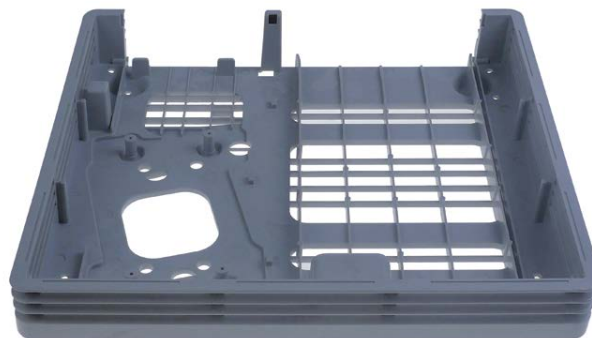

1			
Part No.	691934	Ref. No.	BSF17027
description	bottom L 423mm W 378mm H 58mm for condenser Mini 4F		

housing and bezels

covers



1			
Part No.	691933	Ref. No.	AM100B39
description	cover LG1000 L 1200mm W 68mm H 305mm		



1			
Part No.	691935	Ref. No.	AM3363
description	cover LG336 L 615mm W 180mm plate thickness max. 1mm		
accessories for	691935		



	Part No.	691936	Ref. No.	AM3364
description	side panel mounting pos. left W 72mm H 183mm thickness 28mm LG336			



1			
Part No.	691936	Ref. No.	AM3364
description	side panel mounting pos. left W 72mm H 183mm thickness 28mm LG336		
accessories for	691936		



	Part No.	691935	Ref. No.	AM3363
description	cover LG336 L 615mm W 180mm plate thickness max. 1mm			



lids



1

Part No.	694242	Ref. No.	N1S418* N6A608
description	lid mounting pos. upper W 860mm D 560mm thickness 60mm plastic		

doors

doors



1

Part No.	694250	Ref. No.	CF100013G
description	door right suitable for refrigerator W 670mm H 1570mm thickness 40mm		



1

Part No.	694233	Ref. No.	CF100013D
description	door right W 670mm H 1570mm thickness 40mm		



1

Part No.	195003	Ref. No.	BSF17012
description	door W 425mm H 565mm thickness 17mm glas		

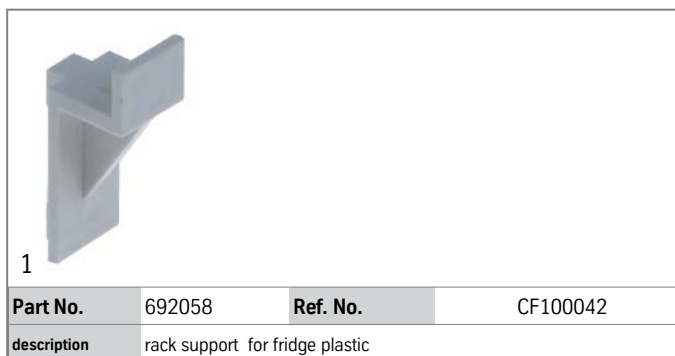
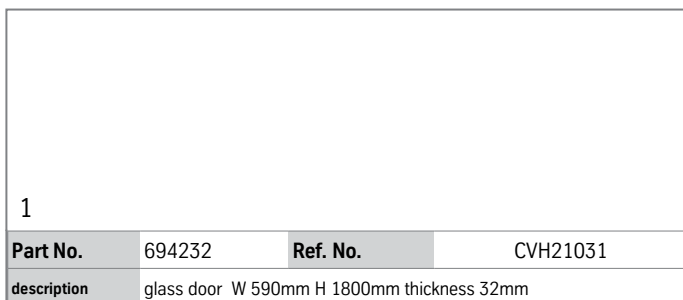
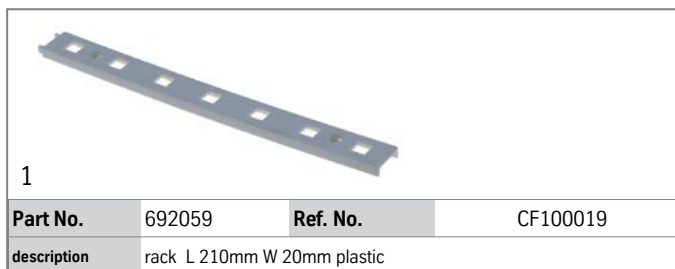
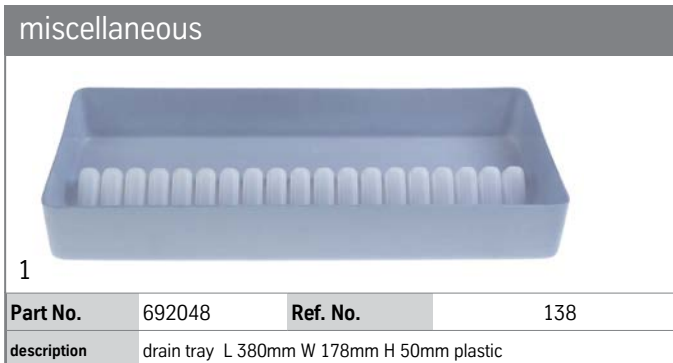
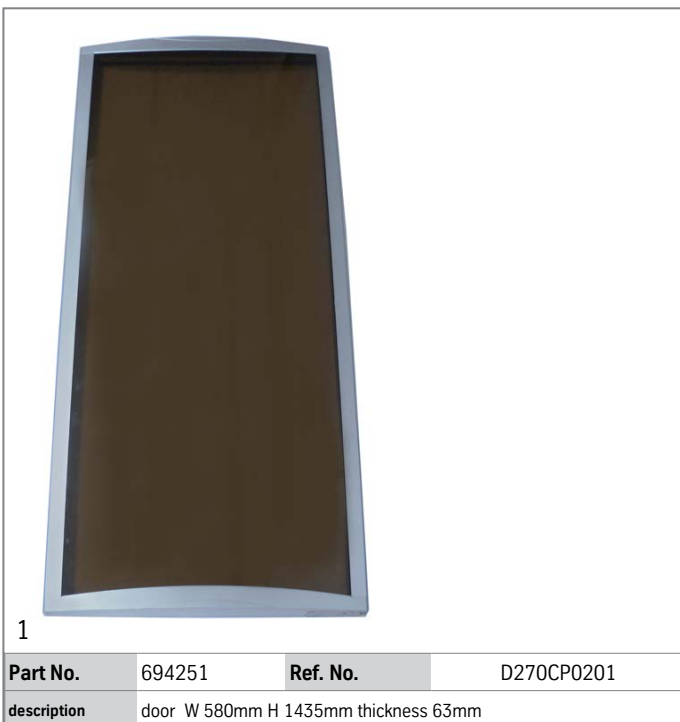



for freezer cabinets

lids



1

Part No.	692049	Ref. No.	BG706103
description	lid for deep freezer W 1010mm D 720mm H 60mm with gasket		

housing and bezels

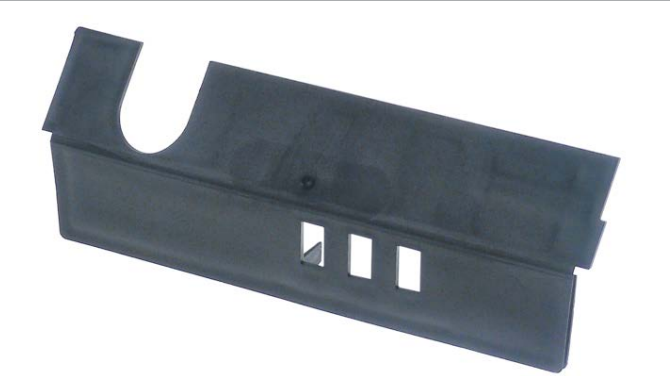

1

Part No.	692052	Ref. No.	127862
description	front panel for deep freezer W 170mm H 55mm		

for display coolers

glass panels

glass panels

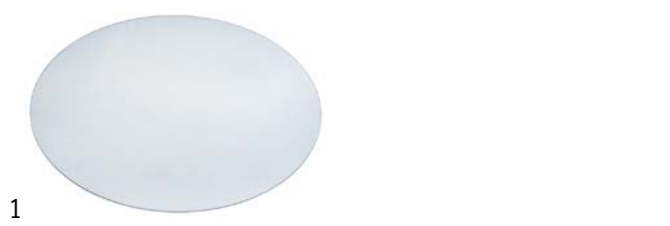

1

Part No.	692050	Ref. No.	SH01017
description	glass panel H 5mm ø 575mm for fridge glas		

doors

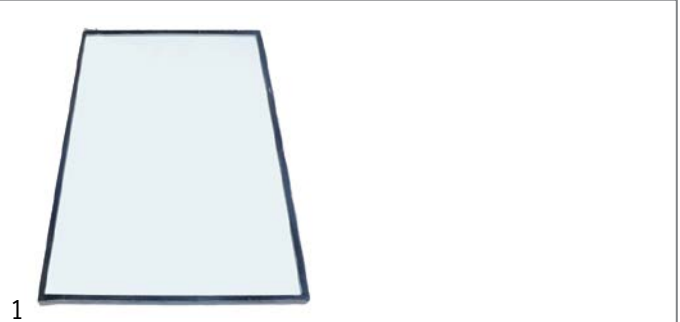

1

Part No.	694228	Ref. No.	BSF17037
description	door W 575mm H 330mm mounting pos. lateral glas thickness 10.6mm		

for ovens

glass panels



1

Part No.	691932	Ref. No.	BSF17038
description	glass panel L 570mm W 389mm thickness 7mm mounting pos. rear Mini 4F		

locks

locking devices

universal

articles not yet classified



1

Part No.	692341	Ref. No.	3414900023
description	key cylinder with key cam length 12mm hole distance 35mm hole ø 4mm ring ø 10.5mm		



hinges

door bearing



1

Part No. 700844 **Ref. No.** SB060420**description** hinge L 34mm W 8mm H 18mm with bolt suitable for VT/VF

equipment feet and end caps

screw-in feet



1

Part No. 701004 **Ref. No.** C6025141**description** equipment foot thread M10 thread L 45mm ø 42mm H 63.5mm Qty 1 pcs suitable for S1000

baskets

miscellaneous

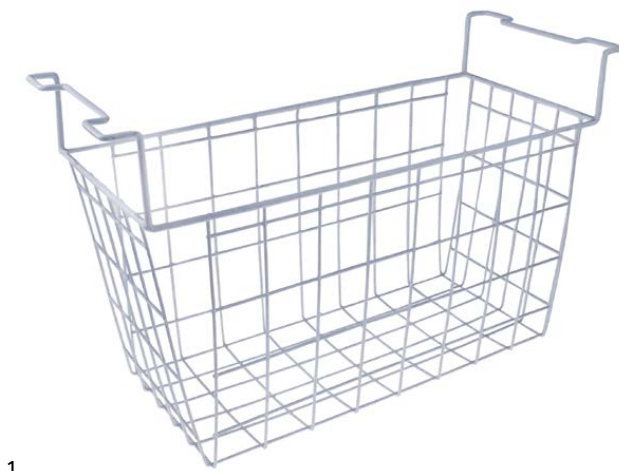

1

Part No. 692051 **Ref. No.** 157585**description** grid basket L 550mm W 220mm H 340mm for deep freezer

shelves and shelf rails

bottle racks

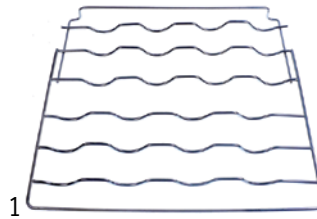

1

Part No. 970657 **Ref. No.** CL270M**description** bottle rack mounting pos. upper & center L 493mm H 40mm W 460mm chrome-plated steel

grates

producer-specific



1

Part No. 970655 **Ref. No.** BSF17010**description** grate W 355mm D 305mm H 18mm chrome-plated steel suitable for Mini 4F

1

Part No. 970656 **Ref. No.** AM33620**description** grate W 438mm D 500mm H 20mm plastic-coated wire gauge frame 6mm lengthwise wires gauge 3mm crossing wires 2 white suitable for LG336

1

Part No. 970702 **Ref. No.** ECO1P20**description** grate W 505mm D 405mm H 23mm plastic-coated steel wire gauge frame 6mm lengthwise wires gauge 4mm crossing wires 3 white

1

Part No. 970658 **Ref. No.** CL1000**description** grate W 550mm D 900mm H 35mm plastic-coated steel 4 shelf supports inclusive wire gauge frame 8mm lengthwise wires gauge 3mm crossing wires 3 suitable for S1000**accessories for** 970658**Part No.** 692044 **Ref. No.** AM100B32

shelf support W 22mm H 18mm L1 31mm L2 30mm



shelf rails and supports

producer-specific



1

Part No.	692046	Ref. No.	LG208H11
description	shelf support aluminium		



1

Part No.	690969	Ref. No.	B6012054
description	shelf support L 33/28mm W 22mm H 18mm		



1

Part No.	692045	Ref. No.	BSF17016
description	shelf support plastic		



1

Part No.	692044	Ref. No.	AM100B32
description	shelf support W 22mm H 18mm L1 31mm L2 30mm		

gaskets

refrigeration gaskets

plug-in gaskets

profile 9049

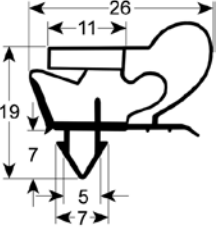

1

Part No.	900920	Ref. No.	A6010056
description	refrigeration gasket profile 9049 W 560mm L 775mm plug size		

profile 9011

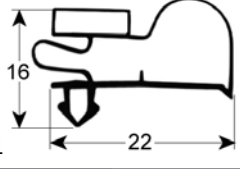

1

Part No.	900942	Ref. No.	CVH13030
description	refrigeration gasket profile 9011 W 560mm L 1175mm plug size		

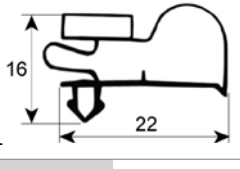

1

Part No.	900943	Ref. No.	CVH21032
description	refrigeration gasket profile 9011 W 560mm L 1770mm plug size		

profile 9156

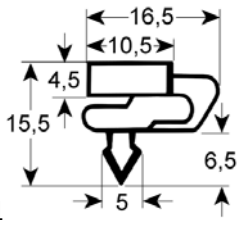

1

Part No.	901648	Ref. No.	AM100B46
description	refrigeration gasket profile 9156 W 595mm L 1340mm plug size Qty 1 pcs		

profile 9967

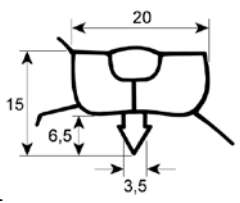

1

Part No.	900921	Ref. No.	BG706102 BG706102/1
description	refrigeration gasket profile 9967 W 960mm L 640mm plug size		



evaporators

for fridges

producer-specific



1

Part No.	750273	Ref. No.	9200005049 AC2PT07
description	evaporator L 375mm W 50mm H 330mm		

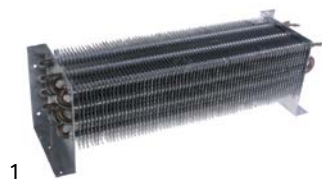

1

Part No.	750265	Ref. No.	AM33646
description	evaporator L 458mm W 138mm H 145mm suitable for LG336		



1

Part No.	750264	Ref. No.	CF100002
description	evaporator L 570mm W 140mm H 150mm with capillary pipe		



1

Part No.	750266	Ref. No.	A6006060
description	evaporator L 775mm W 105mm H 217mm suitable for S1000		

condensers

condensers



1

Part No.	750274	Ref. No.	CF100024
description	condenser W 410mm D 110mm H 220mm		

evaporation and condensing trays

evaporation trays



1

Part No.	750275	Ref. No.	B6030249
description	evaporation tray L 887mm W 228mm H 40mm for evaporator		

hoses

industrial hoses

silicone hoses

without fabric

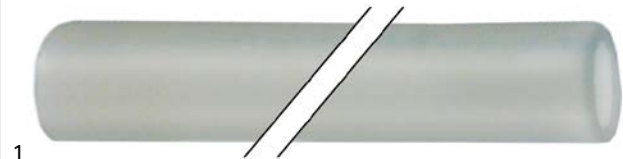

1

Part No.	530053	Ref. No.	7
description	silicone hose ID ø 8mm ED ø 13mm L 1.85m thickness 2.5mm transparent		

GASTROPARTS.COM

