



GASTROPARTS

Jemi

[EN] Equipment

[DE] Geräte

[ES] Aparatos

[FR] Équipement

[IT] Attrezzature

[PL] Urządzenia

[RU] Оборудование

✉ gastroparts@gastroparts.com

☎ +48 56 657 00 66

📘 fb.com/gastroparts.global

GASTROPARTS.COM





heating elements

dry heating elements for dishwashers









Part No.	420321	Ref. No.	2001302
description	heating element 1100W 240V heating circuits 1 L 185mm W 220mm tube \varnothing 6.5mm connection male faston 6.3mm for drying warewashing 2 hole fixing thread 1/4" mounting distance 214mm		
For models:	A-1500-T, A-1500-TDI, A-1500-TDICV, A-1500-TID, A-1500-TIDCV, A-2460-T, MA-MC		

immersion heating elements

with round flange \varnothing 47.5mm



Part No.	418076	Ref. No.	2001120 2001121
description	heating element 2400W 230V heating circuits 1 mounting \varnothing 47.5mm L 245mm W 33mm H 29mm round flange connection male faston 6.3mm immersion heater tube \varnothing 6.5mm thermostat sleeves \varnothing 6mm number of thermostat sleeves 1 length thermostat sleeves 210mm		
For models:	GS-1, GS-16, GS-18, GS-19, GS-2, GS-3, GS-4-2, GS-4-2AF, GS-5AF, GS-6, GS-6AF, GS-7, GS-8-2, GS-9		
spare parts for	418076		
	Part No.	510408	Ref. No. 2514180
	O-ring EPDM thickness 5.34mm ID \varnothing 47mm Qty 1 pcs		
accessories for	418076		
	Part No.	510408	Ref. No. 2514180
	O-ring EPDM thickness 5.34mm ID \varnothing 47mm Qty 1 pcs		
	Part No.	510562	Ref. No. —
	O-ring silicone thickness 5.34mm ID \varnothing 47mm Qty 1 pcs		
	Part No.	520235	Ref. No. —
	3 hole flange hole distance 70.5mm perforation \varnothing 6.5mm ID \varnothing 53.5mm		
	Part No.	520236	Ref. No. —
	flange for heating element ID \varnothing 50mm ED \varnothing 90mm hole \varnothing 6.5mm 3 holes		
	Part No.	550002	Ref. No. —
	tension strap H 10mm L 21mm W 10mm hole \varnothing 6.5mm for heating element		
	Part No.	550362	Ref. No. —
	blind flange \varnothing 64mm mounting \varnothing 47.5mm		



Part No.	418756	Ref. No.	2001211 2001225
description	heating element 2600W 240V heating circuits 1 mounting \varnothing 47.5mm L 185mm W 43mm H 35mm round flange connection male faston 6.3mm immersion heater tube \varnothing 6.5mm H1 20mm H2 15mm connection length 25mm		
For models:	GS-1, GS-16, GS-18, GS-19, GS-2, GS-3, GS-4-2, GS-4-2AF, GS-5AF, GS-6, GS-6AF, GS-7, GS-8-2, GS-9		
accessories for	418756		
	Part No.	510408	Ref. No. 2514180
	O-ring EPDM thickness 5.34mm ID \varnothing 47mm Qty 1 pcs		
	Part No.	510562	Ref. No. —
	O-ring silicone thickness 5.34mm ID \varnothing 47mm Qty 1 pcs		
	Part No.	520235	Ref. No. —
	3 hole flange hole distance 70.5mm perforation \varnothing 6.5mm ID \varnothing 53.5mm		
	Part No.	520236	Ref. No. —
	flange for heating element ID \varnothing 50mm ED \varnothing 90mm hole \varnothing 6.5mm 3 holes		
	Part No.	550002	Ref. No. —
	tension strap H 10mm L 21mm W 10mm hole \varnothing 6.5mm for heating element		
	Part No.	550362	Ref. No. —
	blind flange \varnothing 64mm mounting \varnothing 47.5mm		











Part No.	420546	Ref. No.	2001182
description	heating element 4500W 240V heating circuits 3 mounting \varnothing 47.5mm L 285mm W 30mm H 35mm tube \varnothing 6.5mm thermostat sleeves \varnothing 6mm number of thermostat sleeves 1 thermostat sleeve 215		
For models:	A-1200, A-1200DI, A-1200DICV, A-1200ID, A-1200IDCV, A-1500-T, A-1500-TDI, A-1500-TDICV, A-1500-TID, A-1500-TIDCV, A-2160, A-2460-T, GS-100, GS-102, GS-19, GS-20, GS-43, GS-7, GS-82, GS-82M, GS-83H, GS-83M, GS-9		



Part No.	420547	Ref. No.	2001188
description	heating element 6000W 254V heating circuits 3 mounting \varnothing 47.5mm L 284mm W 30mm H 45mm cable length 2000mm tube \varnothing 6.5mm L1 30mm L2 70mm L3 165mm thermostat sleeves \varnothing 6mm number of thermostat sleeves 1		
For models:	A-1200, A-1500-T, A-2160, A-2460-T, GS-100, GS-102, GS-30, GS-82, GS-82M, GS-83H, GS-83M, GSP-45, GSP-46, MA-MC		











			
Part No.	415493	Ref. No.	2001187
description	heating element 6600W 240V heating circuits 3 mounting ϕ 47.5mm L 282mm W 35mm H 57mm round flange connection male faston 6.3mm immersion heater H1 35mm H2 22mm L1 20mm L2 52mm L3 210mm thermostat sleeves ϕ 7mm number of thermostat sleeves 1 length thermostat sleeves 215mm thermostat sleeve eccentric, non clinging		
For models:	A-1200, A-1200DI, A-1200DICV, A-1200ID, A-1200IDCV, A-1500-T, A-1500-TDI, A-1500-TDICV, A-1500-TID, A-1500-TIDCV, A-2160, A-2460-T, A-2980-TDI, A-2980-TDICV, A-2980-TID, A-2980-TIDCV, GS-100, GS-102, GS-30, GS-82, GS-82M, GS-83H, GS-83M, GSP-45, GSP-46, MA-MC		
accessories for	415493		
	Part No.	510562	Ref. No. —
	O-ring silicone thickness 5.34mm ID ϕ 47mm Qty 1 pcs		
	Part No.	520235	Ref. No. —
	3 hole flange hole distance 70.5mm perforation ϕ 6.5mm ID ϕ 53.5mm		
	Part No.	520236	Ref. No. —
	flange for heating element ID ϕ 50mm ED ϕ 90mm hole ϕ 6.5mm 3 holes		
	Part No.	550002	Ref. No. —
	tension strap H 10mm L 21mm W 10mm hole ϕ 6.5mm for heating element		
	Part No.	550362	Ref. No. —
	blind flange ϕ 64mm mounting ϕ 47.5mm		

			
Part No.	417743	Ref. No.	2001192
description	heating element 9000W 240V heating circuits 3 mounting ϕ 47.5mm L 425mm W 25mm H 50mm round flange connection male faston 6.3mm tube ϕ 6.5mm H1 30mm H2 20mm L1 30mm L2 70mm L3 325mm thermostat sleeves ϕ 7.5mm number of thermostat sleeves 1 length thermostat sleeves 217mm		
For models:	A-2980-TDI, A-2980-TDICV, A-2980-TID, A-2980-TIDCV, GS-102, GS-83H, GS-83M, GSP-45, MA-MC		
spare parts for	417743		
	Part No.	510408	Ref. No. 2514180
	O-ring EPDM thickness 5.34mm ID ϕ 47mm Qty 1 pcs		

with round flange ϕ 60.0mm

			
Part No.	418840	Ref. No.	2001232
description	heating element 4800W 240V heating circuits 3 mounting ϕ 60mm L 295mm W 58mm tube ϕ 6.3mm		
For models:	GS-19, GS-20, GS-30, GS-43, GS-7, GS-9		

			
Part No.	420114	Ref. No.	240001
description	heating element 500W 230V heating circuits 1 L 365mm W 40mm thread M12x1 mounting distance 31.5mm tube ϕ 8.5mm connection length 18mm immersion heater connection M4 for bain marie		
accessories for	420114		
	Part No.	520229	Ref. No. —
	nut thread M12x1 H 4mm WS 16 zinc-coated steel Qty 1 pcs		
	Part No.	521110	Ref. No. —
	flat gasket fibre ED ϕ 20mm ID ϕ 13mm thickness 2mm Qty 1 pcs		
	Part No.	521131	Ref. No. —
	nut thread M12x1 H 3.5mm WS 17 SS Qty 1 pcs		

			
Part No.	420115	Ref. No.	240002
description	heating element 750W 230V heating circuits 1 L 533mm W 40mm thread M12x1 mounting distance 31.5mm tube ϕ 8.5mm connection length 18mm immersion heater connection M4 for bain marie		
accessories for	420115		
	Part No.	520229	Ref. No. —
	nut thread M12x1 H 4mm WS 16 zinc-coated steel Qty 1 pcs		
	Part No.	521110	Ref. No. —
	flat gasket fibre ED ϕ 20mm ID ϕ 13mm thickness 2mm Qty 1 pcs		
	Part No.	521131	Ref. No. —
	nut thread M12x1 H 3.5mm WS 17 SS Qty 1 pcs		

accessories

sealing washers

O-rings

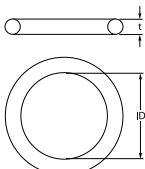
			
			
Part No.	510408	Ref. No.	2514180
description	O-ring EPDM thickness 5.34mm ID ϕ 47mm Qty 1 pcs		
For models:	A-1200, A-1200DI, A-1200DICV, A-1200ID, A-1200IDCV, A-1500-T, A-1500-TDI, A-1500-TDICV, A-1500-TID, A-1500-TIDCV, A-2160, A-2460-T, A-2980-TDI, A-2980-TDICV, A-2980-TID, A-2980-TIDCV, GS-1, GS-100, GS-102, GS-16, GS-18, GS-19, GS-2, GS-20, GS-3, GS-30, GS-4-2, GS-4-2AF, GS-43, GS-5AF, GS-6, GS-6AF, GS-7, GS-80, GS-82, GS-8-2, GS-82M, GS-83H, GS-83M, GS-9, GSP-45, GSP-46, MA-MC		



hot plates

round

with radiused edge

for domestic and commercial kitchens



1

Part No.	490016	Ref. No.	240023
description	hot plate ø 180mm 2000W 230V connection 4 screw clamps with 8mm spill ring		



1

Part No.	490020	Ref. No.	240044	
description	hot plate ø 220mm 2600W 230V connection 4 screw clamps with 8mm spill ring			
accessories for	490020			
	Part No.	550796	Ref. No.	—
	fixing plate for hot plate ø220mm			

thermostats

control and safety thermostats

EGO

control thermostats

55.13_ series



1

Part No.	375527	Ref. No.	2006001 2006005
description	thermostat t.max. 200°C temperature range 60-200°C 1-pole 1N0 16A probe ø 6mm probe L 77mm capillary pipe 870mm capillary pipe isolatedmm gland nut M9x1 shaft L 23mm shaft position upper rotation 270°		



1

Part No.	375505	Ref. No.	2006061
description	thermostat t.max. 320°C temperature range 50-320°C 1-pole 1N0 16A probe ø 3mm probe L 160mm capillary pipe 870mm capillary pipe isolatedmm gland nut shaft ø 6x4.6mm shaft L 23mm shaft position upper rotation 270°		
For models:	A-1500-T, A-1500-TDI, A-1500-TDICV, A-1500-TID, A-1500-TIDCV, A-2460-T, A-2980-TDI, A-2980-TDICV, A-2980-TID, A-2980-TIDCV, MA-MC		



1

Part No.	375526	Ref. No.	2006053
description	thermostat t.max. 93°C temperature range 31-93°C 1-pole 1C0 16A probe ø 6mm probe L 98mm capillary pipe 2380mm capillary pipe isolatedmm gland nut M9x1 shaft L 23mm shaft position upper rotation 270°		
For models:	A-1200, A-1200DI, A-1200DICV, A-1200ID, A-1200IDCV, A-1500-T, A-1500-TDI, A-1500-TDICV, A-1500-TID, A-1500-TIDCV, A-2160, A-2460-T, A-2980-TDI, A-2980-TDICV, A-2980-TID, A-2980-TIDCV, GS-1, GS-100, GS-102, GS-16, GS-18, GS-19, GS-2, GS-20, GS-3, GS-30, GS-4-2, GS-4-2AF, GS-5AF, GS-6, GS-6AF, GS-7, GS-80, GS-82, GS-8-2, GS-82M, GS-83H, GS-83M, GS-9, GSP-45, GSP-46, MA-MC		

safety thermostats

55.13_ series



1

Part No.	375214	Ref. No.	2006062
description	safety thermostat switch-off temp. 140°C 1-pole 16A probe ø 6mm probe L 77mm capillary pipe 1540mm capillary pipe isolated 1350mm gland nut probe SS		
For models:	A-1200, A-1200DI, A-1200DICV, A-1200ID, A-1200IDCV, A-1500-T, A-1500-TDI, A-1500-TDICV, A-1500-TID, A-1500-TIDCV, A-2160, A-2460-T, A-2980-TDI, A-2980-TDICV, A-2980-TID, A-2980-TIDCV, GS-1, GS-100, GS-102, GS-16, GS-18, GS-19, GS-2, GS-20, GS-30, GS-5AF, GS-6, GS-6AF, GS-7, GS-82, GS-82M, GS-83H, GS-83M, GSP-45, GSP-46, MA-MC		



accessories

gland nut accessories

ducts

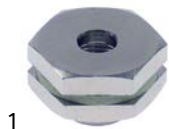

1

Part No.	551229	Ref. No.	2037051
description	gland duct ET M14x1 IT M9x1 probe ø max. 7mm WS 22 FIBER SS L 15mm		
For models:	A-1200, A-1200DI, A-1200DICV, A-1200ID, A-1200IDCV, A-1500-T, A-1500-TDI, A-1500-TDICV, A-1500-TID, A-1500-TIDCV, A-2160, A-2460-T, A-2980-TDI, A-2980-TDICV, A-2980-TID, A-2980-TIDCV, GS-100, GS-102, GS-18, GS-19, GS-3, GS-4-2, GS-4-2AF, GS-6, GS-6AF, GS-80, GS-82, GS-8-2, GS-82M, GSP-46, MA-MC		

washers with slot



1

Part No.	510241	Ref. No.	1502060
description	washer with slot ED ø 7.8mm slit width 1.3mm Qty 10		
For models:	A-1500-T, A-2460-T, MA-MC		

gaskets





1

Part No.	510655	Ref. No.	2519002
description	gasket silicone ø 7.8mm L 5mm blue Shore 55° Qty 10 pcs		
For models:	A-1500-T, A-2460-T, MA-MC		

bolts with slot



1

Part No.	520243	Ref. No.	2037050	
description	bolt with slot thread M9x1 Qty 10 pcs nickel-plated brass			
For models:	A-1500-T, A-2460-T, GS-30, GS-43, MA-MC			
accessories for	520243			
	Part No.	510591	Ref. No.	—
	washer with slot ED ø 8.8mm slit width 1.2mm Qty 10			
	Part No.	510592	Ref. No.	—
	gasket ø 8x8.7mm Qty 10 pcs slotted silicone			

switches and momentary switches

rocker/momentary rocker switches

25.5x25mm



1

Part No.	346869 ¹	Ref. No.	2002048 2002049	
description	rocker switch mounting measurements 25.5x25mm green 2NO 250V 16A illuminated main switch connection male faston 6.3mm ambient temperature max. 85°C protection IP40			
For models:	A-1200, A-1500-T, A-2160, A-2460-T, GS-100, GS-18, GS-19, GS-2, GS-20, GS-3, GS-6, GS-6AF, GS-7, GS-82, GS-82M			
accessories for	346869			
	Part No.	301323	Ref. No.	—
	protective cover external size 35x35mm H 11mm transparent suitable for rocker switch mounting measurements 25.5x25mm L 35mm W 35mm			

¹illuminated

27.8x25mm



1

Part No.	347868	Ref. No.	2003046
description	momentary rocker switch mounting measurements 27.8x25mm white 1NO/indicator light 250V 16A drain pump connection male faston 6.3mm ambient temperature max. 85°C protection IP40		
For models:	GS-18, GS-2		



1

Part No.	347173 ¹	Ref. No.	2003049
description	momentary rocker switch mounting measurements 27.8x25mm white 2NO 250V 16A illuminated programme connection male faston 6.3mm ambient temperature max. 85°C protection IP40		
For models:	A-1200, A-1500-T, A-2160, A-2460-T, GS-100, GS-18, GS-19, GS-2, GS-20, GS-3, GS-6, GS-6AF, GS-7, GS-82		

¹illuminated



1

Part No.	510281	Ref. No.	4030009
description	blank black mounting measurements 27.8x25mm		
For models:	GS-18, GS-19, GS-2, GS-20, GS-3, GS-30, GS-43, GS-6, GS-6AF, GS-7		



push/momentary push switches

30x22mm



Part No.	347024	Ref. No.	2003302
description	momentary push switch mounting measurements 30x22mm white 1NO/indicator light 250V 16A connection male faston 6.3mm ambient temperature max. 85/55°C protection IP40		
For models:	A-1200, A-1500-T, A-2160, A-2460-T, GS-102, GS-83H, GS-83M		



Part No.	345235 ¹	Ref. No.	2002423
description	push switch mounting measurements 30x22mm green 2NO 250V 16A illuminated connection male faston 6.3mm ambient temperature max. 85°C protection IP40		
For models:	A-1200, A-1500-T, A-2160, A-2460-T, GS-1, GS-102, GS-16, GS-5AF, GS-83H, GS-83M, GSP-45, GSP-46		

¹illuminated

cam switches

on/off



Part No.	301281	Ref. No.	2004051
description	cam switch 2 operating positions 2NO sequence 0-1 25A shaft \varnothing 6x4.6mm shaft L 23mm connection male faston 6.3mm plastic		
For models:	GS-18, GS-19, GS-30, GS-4-2, GS-4-2AF, GS-6, GS-6AF, GS-82, GS-8-2, GS-82M, GS-9		

4-position



Part No.	300023	Ref. No.	240045
description	cam switch 4 operating positions 1NO/2CO sequence 0-1-2-3 16A shaft \varnothing 6x4.6mm shaft L 23mm connection screw 4-position ceramic		

rotary switches

accessories

levers



Part No.	347866	Ref. No.	2016102
description	lever ON-OFF lever length 115mm L 90mm W 90mm shaft 8x8mm mounting distance 68mm		
For models:	A-2980-TDI, A-2980-TDICV, A-2980-TID, A-2980-TIDCV, MA-MC		

magnetic switches

29x19mm

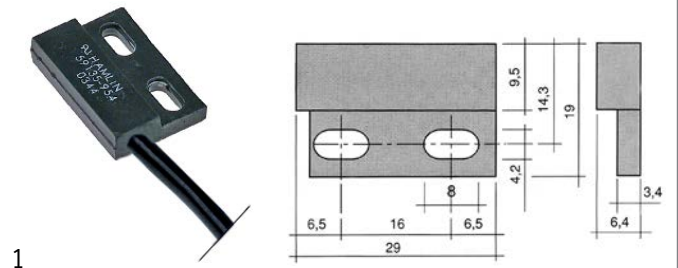

Part No.	347025	Ref. No.	2019118 2019119
description	magnetic switch with holder L 29mm W 19mm 1NO 250V 0.04A P max. 10W cable length 1000mm		
For models:	GS-1, GS-16, GS-18, GS-19, GS-2, GS-20, GS-5AF, GS-6, GS-6AF, GS-7		
spare parts for	347025		
	Part No.	345117	Ref. No. —
	magnetic switch L 28.5mm W 19mm 1NO 250V 0.04A P max. 10W connection cable cable length 1000mm		

36x13mm

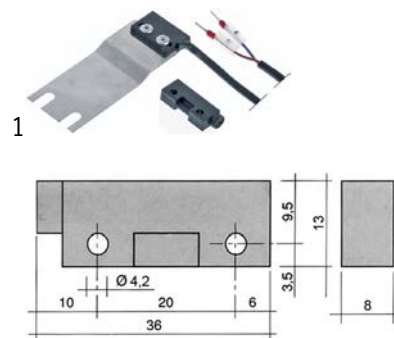

Part No.	347867	Ref. No.	2019183
description	magnetic switch complete incl. holder L 29mm W 19mm 1NO 250V 0.4A P max. 100W connection cable cable length 1000mm STEM		
For models:	GS-102, GS-83H, GS-83M		
spare parts for	347867		
	Part No.	345398	Ref. No. —
	magnet \varnothing mm L 36mm H 8mm W 13mm hole distance 20mm M3 hole \varnothing 3mm		



65x20mm

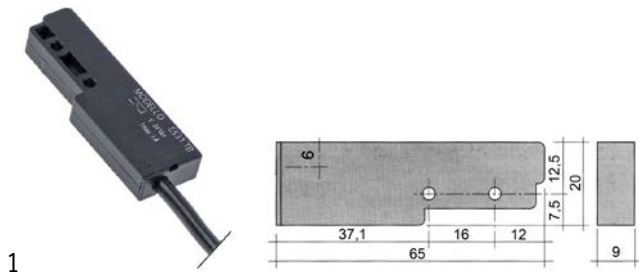

1	Part No.	347911	Ref. No.	2019101
---	-----------------	--------	-----------------	---------

description	magnetic switch L 65mm W 20mm 1NO 24V 3A P max. 72W connection cable cable length 2000mm
For models:	A-1200DI, A-1200DICV, A-1200ID, A-1200IDCV, A-1500-TDI, A-1500-TDICV, A-1500-TID, A-1500-TIDCV, A-2980-TDI, A-2980-TDICV, A-2980-TID, A-2980-TIDCV, MA-MC

accessories

magnets

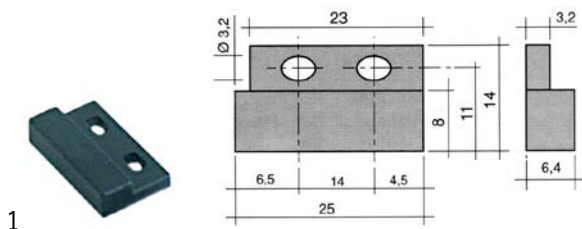

1	Part No.	345432	Ref. No.	2019120
---	-----------------	--------	-----------------	---------

description	magnet \varnothing mm L 25mm H 6.4mm W 14mm hole distance 13mm M3 hole \varnothing 3.2mm
For models:	GS-1, GS-16, GS-18, GS-19, GS-2, GS-20, GS-5AF, GS-6, GS-6AF, GS-7

lamps

indicator lights

indicator lights (complete)

 \varnothing 13mm

with screw socket



1	Part No.	357076	Ref. No.	240048
---	-----------------	--------	-----------------	--------

description	indicator light \varnothing 13mm 400V green connection screw
--------------------	--



1	Part No.	357077	Ref. No.	240049
---	-----------------	--------	-----------------	--------

description	indicator light \varnothing 13mm 400V yellow connection screw
--------------------	---

26.5x25.6mm



1	Part No.	358102	Ref. No.	2014030
---	-----------------	--------	-----------------	---------

description	indicator light mounting measurements 27.8x25mm green 220-250V connection male faston 6.3mm temp.-resist. 85°C
--------------------	--

For models:	GS-18, GS-19, GS-30, GS-43, GS-6, GS-6AF
--------------------	--



1	Part No.	345796	Ref. No.	2014025 2014032
---	-----------------	--------	-----------------	--------------------

description	indicator light mounting measurements 27.8x25mm white 230V connection male faston 6.3mm
--------------------	---

For models:	GS-100, GS-18, GS-19, GS-2, GS-20, GS-3, GS-30, GS-4-2, GS-4-2AF, GS-43, GS-6, GS-6AF, GS-7, GS-82, GS-8-2, GS-82M, GS-9
--------------------	--



1	Part No.	347869	Ref. No.	2014031
---	-----------------	--------	-----------------	---------

description	indicator light mounting measurements 27.8x25mm white 250V connection male faston 6.3mm type cycle
--------------------	--

For models:	GS-18, GS-19, GS-30, GS-43, GS-6, GS-6AF, GS-82, GS-82M
--------------------	---

30x22mm



1	Part No.	357011	Ref. No.	2014146
---	-----------------	--------	-----------------	---------

description	indicator light mounting measurements 30x22mm 230V white connection male faston 6.3mm temp.-resist. 85°C type Marquardt 1667..
--------------------	--

For models:	A-1200, A-1500-T, A-2160, A-2460-T, GS-1, GS-102, GS-16, GS-5AF, GS-83H, GS-83M, GSP-45
--------------------	---



timers

programme timers



1

Part No.	360430	Ref. No.	2005003 old
description	timer AKO-DIEHL 514 chambers 3 240V shaft \varnothing 6x4.6mm shaft L 13mm manif. no. 514028		



1

Part No.	360412	Ref. No.	2005003 2005103
description	timer CDC 11804 engines 1 chambers 4 operation time 120s 230V shaft \varnothing 6x4.6mm shaft L 23mm manif. no. 11804F1PMD run-time 120s		
For models:	GS-1, GS-100, GS-16, GS-18, GS-19, GS-2, GS-20, GS-3, GS-30, GS-4-2, GS-4-2AF, GS-43, GS-5AF, GS-6, GS-6AF, GS-7, GS-80, GS-82, GS-8-2, GS-82M, GS-9, GSP-45, GSP-46		

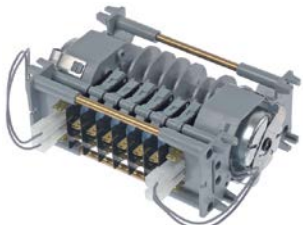

1

Part No.	360561	Ref. No.	2005083
description	timer CDC 7806DV engines 2 chambers 6 operation time 6s / 2min 230V 50Hz shaft \varnothing 6mm shaft Lmm manif. no. 7806DV motor type M37R/M37L voltage AC		
For models:	GS-102, GS-83H, GS-83M		



1

Part No.	360764	Ref. No.	2005107
description	timer CROUZET 600 engines 1 chambers 3 operation time 20min 230V shaft \varnothing 6x4.6mm shaft L 13mm manif. no. 2030/2555T7588233679		



1

Part No.	360429	Ref. No.	2005007
description	timer FIBER P25 engines 1 chambers 3 operation time 20min 230V shaft \varnothing 6mm shaft Lmm manif. no. P255J03L193		
For models:	GS-18, GS-19, GS-2, GS-20, GS-3, GS-4-2, GS-4-2AF, GS-6, GS-6AF, GS-7, GS-8-2, GS-9		
spare parts for	360429		
		Part No.	360673
		Ref. No.	—
	motor kit pinion \varnothing 6.8mm teeth 15 230V voltage AC 50/60Hz turn direction clockwise motor \varnothing 48mm H 18.5mm motor type UDS-40NE1RNZ165 cable length 150mm with holder		

contactors

TELEMECANIQUE (Schneider Electric)

power contactors



1

Part No.	380967	Ref. No.	2008321
description	power contactor resistive load 20A 230VAC (AC3/400V) 9A/4kW main contacts 3NO auxiliary contacts 1NO connection screw connection type LC1K0910M7		
For models:	GS-19, GS-20, GS-3, GS-30, GS-4-2, GS-4-2AF, GS-6, GS-6AF, GS-7, GS-8-2, GS-9		



1

Part No.	380479	Ref. No.	2008325
description	power contactor resistive load 25A 230VAC (AC3/400V) 9A/4kW main contacts 3NO auxiliary contacts 1NO/1NC connection screw connection type LC1D09P7		
For models:	GS-100, GS-102, GS-43, GS-82, GS-82M, GS-83H, GS-83M, GSP-45, GSP-46		







relays

power relays

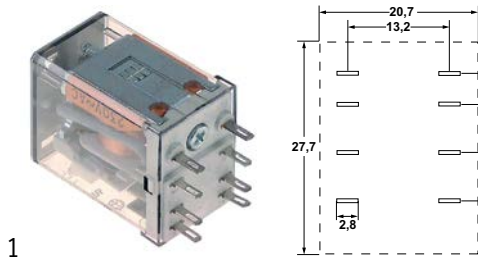
with male contacts



female contact 2.0mm



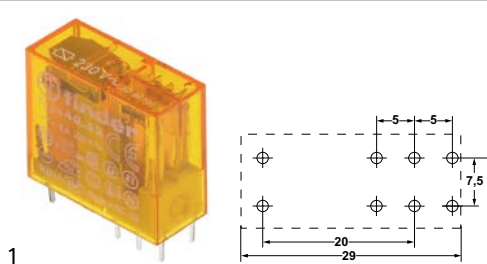

Part No.	380377	Ref. No.	2054010
description	power relays FINDER 220-240VAC 10A 2CO connection F2 plug-in connection manuf. no. 55.32.8.230.0000 94.92.3 250V		
For models:	A-1200, A-1500-T, A-2160, A-2460-T, GS-102, GS-83H, GS-83M, GSP-45, GSP-46		
accessories for	380377		
	Part No.	380341	Ref. No. —
	relay socket 4-pole contacts 12 300V voltage AC 6A Italiana Relè manuf. no. ZMD4		
	Part No.	380378	Ref. No. —
	relay socket 2-pole 55/85 dimensions 70.5x30x27mm 250V voltage AC 10A FINDER manuf. no. 94.72		
	Part No.	380384	Ref. No. —
	relay socket 2-pole contacts male faston 2.8mm 250V voltage AC 10A W 23mm for		
	Part No.	380399	Ref. No. —
	relay socket 4-pole dimensions 76.2x27x86.1mm 250V voltage AC 1A FINDER manuf. no. 94.94.3		

plug-in/print relays

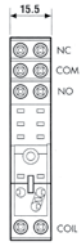

Part No.	380333	Ref. No.	2054012
description	print relay 230VAC 2CO at 250V 8A connection pins raster size 5mm FINDER manuf. no. 40.52.8.230.0000 95.65/95.75		
For models:	GS-1, GS-16, GS-18, GS-19, GS-2, GS-20, GS-5AF, GS-6, GS-6AF, GS-7		
accessories for	380333		
	Part No.	380340	Ref. No. —
	relay socket dimensions 62x36x15mm 250V voltage AC 10A Italiana Relè manuf. no. ZMEM/5		
	Part No.	380505	Ref. No. —
	relay socket 2CO 40.52 dimensions 81.9x15.5x75mm 250V voltage AC 10A FINDER manuf. no. 95.95.3		
	Part No.	381181	Ref. No. 2054013
	relay socket 2-pole 40.51/40.52/40.61 connection screw clamp dimensions 15.8x78.6mm 250V voltage AC 10A FINDER manuf. no. 95.75		

relay sockets

			
Part No.	381181	Ref. No.	2054013
description	relay socket 2-pole 40.51/40.52/40.61 connection screw clamp dimensions 15.8x78.6mm 250V voltage AC 10A FINDER manuf. no. 95.75		
For models:	GS-16, GS-18, GS-19, GS-2, GS-20, GS-5AF, GS-6, GS-6AF, GS-7		
accessories for	381181		
	Part No.	381455	Ref. No. —
	support bracket		

time relays

time relays

			
Part No.	360554	Ref. No.	2054101
description	time relay TELEMECANIQUE RE17RMMU time range 0.1s-100h 24-240VAC/24VDC 8A mounting measurements DIN railmm 1CO connection screw connection		
For models:	A-1200, A-1200DI, A-1200DICV, A-1200ID, A-1200IDCV, A-1500-T, A-1500-TDI, A-1500-TDICV, A-1500-TID, A-1500-TIDCV, A-2160, A-2460-T, A-2980-TDI, A-2980-TDICV, A-2980-TID, A-2980-TIDCV, GS-18, GS-19, GS-2, GS-20, GS-43, GS-6, GS-6AF, GS-7, GS-83H, GS-83M, GSP-45, GSP-46, MA-MC		

probes

producer-specific probes

probes

			
Part No.	378338	Ref. No.	2028024
description	temperature probe Pt100 cable silicone probe -100 up to 450°C cable -50 up to +180°C connection 3-wire thread M11x1.25 probe ø6x90mm cable length 2m		
For models:	A-1200DI, A-1200DICV, A-1200ID, A-1200IDCV, A-1500-TDI, A-1500-TDICV, A-1500-TID, A-1500-TIDCV, A-2980-TDI, A-2980-TDICV, A-2980-TID, A-2980-TIDCV, MA-MC		



solenoid valves

solenoid valves (water)

ROBERTSHAW/INVENSYS

medium temperature: 90°C 90°C 60°C
 ambient temperature: 60°C 25°C 60°C
 duty cycle: 40% 100% 100%



1

Part No.	372021	Ref. No.	2017022
description	solenoid valve double straight 230VAC inlet 3/4" outlet 11.5mm DN10 EATON (INVENSYS)		
For models:	A-1200, A-1500-T, A-2160, A-2460-T, GS-100, GS-102, GS-18, GS-19, GS-2, GS-20, GS-3, GS-4-2, GS-4-2AF, GS-6, GS-6AF, GS-7, GS-82, GS-8-2, GS-83H, GS-9, GSP-45, MA-MC		

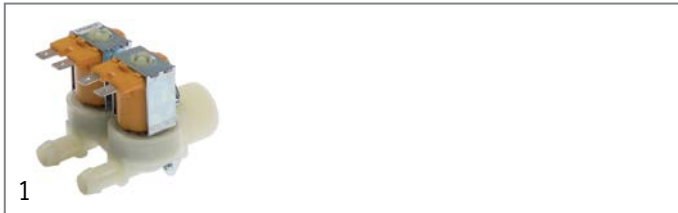

1

Part No.	370724	Ref. No.	2017024
description	solenoid valve double straight 24VAC inlet 3/4" outlet 11.5mm DN10 t.max. 90°C Invensys plastic		
For models:	A-1200DI, A-1200DICV, A-1200ID, A-1200IDCV, A-1500-TDI, A-1500-TDICV, A-1500-TID, A-1500-TIDCV, A-2980-TDI, A-2980-TDICV, A-2980-TID, A-2980-TIDCV, MA-MC		



1

Part No.	372017	Ref. No.	2017007
description	solenoid valve single straight 230VAC inlet 3/4" outlet 11.5mm DN10 EATON (INVENSYS)		
For models:	A-2160, A-2460-T, GS-100, GS-102, GS-18, GS-19, GS-2, GS-20, GS-3, GS-30, GS-4-2, GS-4-2AF, GS-6, GS-6AF, GS-7, GS-82, GS-8-2, GS-82M, GS-83H, GS-83M, GS-9, GSP-45, GSP-46		



1

Part No.	370723	Ref. No.	2017010
description	solenoid valve single straight 24VAC/DC inlet 3/4" outlet 11.5mm DN10 Invensys plastic		
For models:	A-2160, A-2460-T, A-2980-TDI, A-2980-TDICV, A-2980-TID, A-2980-TIDCV, MA-MC		

spare parts and accessories

reducers

outlet side



1

Part No.	371327	Ref. No.	1026001
description	reducer Invensys ø 8mm mounting measurements 8mm dark blue		
For models:	GS-18, GS-19, GS-2, GS-20, GS-3, GS-4-2, GS-4-2AF, GS-6, GS-6AF, GS-7, GS-8-2, GS-9		

pressure switches

for warewashing

ø 58mm with male faston 6.3mm

with connection horizontal



1

Part No.	541911	Ref. No.	2007004
description	pressure control pressure range 108/78mbar connection 6mm ø 58mm pressure connection horizontal warewashing pressure connection ø 6mm		
For models:	A-2160, A-2460-T, A-2980-TDI, A-2980-TDICV, A-2980-TID, A-2980-TIDCV, MA-MC		

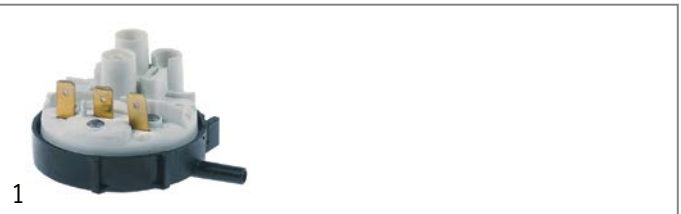

1

Part No.	541569	Ref. No.	2007001
description	pressure control pressure range 35/15mbar connection 6mm ø 58mm pressure connection horizontal warewashing		
For models:	GS-1, GS-100, GS-16, GS-18, GS-19, GS-2, GS-20, GS-3, GS-30, GS-4-2, GS-4-2AF, GS-5AF, GS-6, GS-6AF, GS-7, GS-82, GS-8-2, GS-82M, GS-9		



∅ 84mm with coded plug



1

Part No.	541990	Ref. No.	2007106
description	pressure control 2 pressure ranges pressure range 62/20 105/25mbar connection 6mm ∅ 84mm pressure connection horizontal warewashing suitable for JEMI pressure connection ∅ 6mm		
For models:	A-1200DI, A-1200DICV, A-1200ID, A-1200IDCV, A-1500-TDI, A-1500-TDICV, A-1500-TID, A-1500-TIDCV, A-2980-TDI, A-2980-TDICV, A-2980-TID, A-2980-TIDCV		



2

Part No.	541910	Ref. No.	2007006
description	pressure control pressure range 62/25 - 90/50mbar connection coded plug ∅ 84mm pressure connection horizontal warewashing suitable for JEMI pressure connection ∅ 6mm		
For models:	A-1200, A-1500-T, A-2160, A-2460-T, MA-MC		

compressors

accessories

starting relays

miscellaneous



1

Part No.	381177	Ref. No.	2042010
description	start relay AL6S/5A 230V voltage AC 5A		
For models:	GS-18, GS-6, GS-6AF		

pumps





wash and rinse pumps

FIR

pumps



1

Part No.	500948	Ref. No.	2011003
description	pump inlet ∅ 28mm outlet ∅ 26mm type 2214.1600 230V 50Hz 1 phase 0.11kW 0.15HP L 197mm rotation direction right capacitor 6.3μF FIR		
For models:	GS-1, GS-2, GS-3		
spare parts for	500948		
	Part No.	365012	Ref. No. 2013002
	operating capacitor capacity 6.3μF 450V tolerance 5% 50Hz ambient temperature max. -25 to +85°C ∅ 30mm L 61mm M8 plastic connection male faston 6.3mm protection		
	Part No.	510510	Ref. No. —
	pump cover pump type 2212/2228/2229/2211		
	Part No.	510695	Ref. No. —
	mechanical shaft seal height counter ring 5.5mm ID ∅ 11mm		
	Part No.	521203	Ref. No. —
	impellor ∅ 72mm H 18mm thread M7 shaft ∅ 11mm shaft length 32mm blades 3		
	Part No.	521703	Ref. No. —
	pump cover gasket EPDM thickness 2.5mm ID ∅ 75mm Qty 1 pcs		



1

Part No.	501401	Ref. No.	2011002
description	pump inlet \varnothing 45mm outlet \varnothing 40mm type 5283 230V 50Hz 1 phase 0.37kW L 205mm FIR		
For models:	GS-4-2, GS-5AF, GS-6, GS-6AF		
spare parts for	501401		
	Part No.	365014	Ref. No. —
	operating capacitor capacity 12.5 μ F 450V tolerance 5%Hz ambient temperature max. -25 to +85°C \varnothing 35mm L 70mm M8 plastic connection male faston 6.3mm 45S.C3DS.12.5 protection		
	Part No.	510608	Ref. No. —
	impellor \varnothing 93mm H 32mm shaft intake \varnothing 9/8mm blades 6 inner height 11mm		
	Part No.	510692	Ref. No. 2041003
	mechanical shaft seal for shaft \varnothing 11mm slide ring ext. \varnothing 24mm slide ring H 13mm counter ring mounting \varnothing 26mm height counter ring 8mm counter ring int. \varnothing 14mm		
	Part No.	521506	Ref. No. —
	pump cover FIR inlet \varnothing 45mm outlet \varnothing 40mm turn direction right \varnothing 160mm ID \varnothing 125mm inner height 25mm		
	Part No.	521702	Ref. No. 2514600
	pump cover gasket thickness 3.5x4.5mm Qty 1 pcs		



1





Part No.	501400	Ref. No.	2011008
description	pump inlet \varnothing 45mm outlet \varnothing 40mm type B206.1500 230V 50Hz 1 phase 0.55kW L 235mm FIR		
For models:	GS-18, GS-19, GS-7, GS-8-2		
spare parts for	501400		
	Part No.	365014	Ref. No. —
	operating capacitor capacity 12.5 μ F 450V tolerance 5%Hz ambient temperature max. -25 to +85°C \varnothing 35mm L 70mm M8 plastic connection male faston 6.3mm 45S.C3DS.12.5 protection		
	Part No.	510508	Ref. No. —
	pump cover FIR inlet \varnothing 45mm outlet \varnothing 40mm pump type PU 0.5/3911 turn direction right \varnothing 160mm ID \varnothing 125mm inner height 25mm		
	Part No.	510600	Ref. No. 4042003
	impellor \varnothing 102mm H 29mm shaft intake \varnothing 9/8mm rotation direction right blades 6		
	Part No.	510692	Ref. No. 2041003
	mechanical shaft seal for shaft \varnothing 11mm slide ring ext. \varnothing 24mm slide ring H 13mm counter ring mounting \varnothing 26mm height counter ring 8mm counter ring int. \varnothing 14mm		
	Part No.	521023	Ref. No. —
	fanwheel cover ED \varnothing 150mm H 70mm for wash pump		
	Part No.	521702	Ref. No. 2514600
	pump cover gasket thickness 3.5x4.5mm Qty 1 pcs		



Part No.	499231	Ref. No.	2011125
description	pump inlet \varnothing 60mm outlet \varnothing 50mm type 2233A2350 230V 50Hz 1 phase 0.75kW L 255mm rotation direction right capacitor 16 μ F FIR inlet \varnothing 60mm outlet \varnothing 50mm		
For models:	GS-20		
spare parts for	499231		
	Part No.	365021	Ref. No. —
	operating capacitor capacity 16 μ F 425V tolerance 5% 50/60Hz ambient temperature max. -25 to +85°C \varnothing 35mm L 73mm single M8 plastic connection male faston 6.3mm 416.10.99 protection		
	Part No.	510529	Ref. No. —
	impeller \varnothing 103mm H 30mm shaft intake \varnothing 9/8mm rotation direction right blades 6		
	Part No.	510552	Ref. No. —
	pump cover gasket pump type 1292-2/3942/3981/3911/3983		
	Part No.	510692	Ref. No. 2041003
	mechanical shaft seal for shaft \varnothing 11mm slide ring ext. \varnothing 24mm slide ring H 13mm counter ring mounting \varnothing 26mm height counter ring 8mm counter ring int. \varnothing 14mm		
	Part No.	521512	Ref. No. —
	pump cover FIR inlet \varnothing 60mm outlet \varnothing 50mm		

LGB



Part No.	500586	Ref. No.	2011004
description	pump inlet \varnothing 45mm outlet \varnothing 39mm type FM4023SX 230V 50Hz 1 phase 0.8kW 1.09HP L 297mm rotation direction right capacitor 16 μ F LGB		
For models:	GS-19, GS-9		
spare parts for	500586		
	Part No.	365021	Ref. No. —
	operating capacitor capacity 16 μ F 425V tolerance 5% 50/60Hz ambient temperature max. -25 to +85°C \varnothing 35mm L 73mm single M8 plastic connection male faston 6.3mm 416.10.99 protection		
	Part No.	510703	Ref. No. —
	mechanical shaft seal for shaft \varnothing 13mm slide ring H 13mm height counter ring 5.5mm ED \varnothing 26mm		
	Part No.	521246	Ref. No. —
	impeller \varnothing 103mm H 26mm thread M8L shaft \varnothing 20mm shaft length 7mm seat \varnothing 8.2mm blades 6		
	Part No.	521542	Ref. No. —
	pump cover LGB inlet \varnothing 45mm outlet \varnothing 40mm auxiliary pressure connection 13mm supporting pressure open \varnothing 150mm ID \varnothing 120mm inner height 25mm		
	Part No.	521714	Ref. No. —
	pump cover gasket thickness 4x4mm Qty 1 pcs		

drain pumps

HANNING



Part No.	500573	Ref. No.	2030002
description	drain pump 30W 4-piece 230V inlet \varnothing 24/30mm outlet \varnothing 24mm 50Hz HANNING type DPS25-032 1x pump, 3x pump cover		
For models:	GS-18, GS-19, GS-2, GS-20, GS-3, GS-4-2, GS-4-2AF, GS-6, GS-6AF, GS-7, GS-8-2, GS-9		



service kits



1

Part No.	500573	Ref. No.	2030002
description	drain pump 30W 4-piece 230V inlet ø 24/30mm outlet ø 24mm 50Hz HANNING type DPS25-032 1x pump, 3x pump cover		
For models:	GS-18, GS-19, GS-2, GS-20, GS-3, GS-4-2, GS-4-2AF, GS-6, GS-6AF, GS-7, GS-8-2, GS-9		

booster pumps II

accessories



1

Part No.	365012	Ref. No.	2013002
description	operating capacitor capacity 6.3µF 450V tolerance 5% 50Hz ambient temperature max. -25 to +85°C ø 30mm L 61mm M8 plastic connection male faston 6.3mm protection		
For models:	GS-1, GS-2, GS-3		

accessories

pump cover gaskets



1

Part No.	521063	Ref. No.	2514380
description	pump cover gasket		
For models:	A-1200, A-1200DI, A-1200DICV, A-1200ID, A-1200IDCV, A-1500-T, A-1500-TDI, A-1500-TDICV, A-1500-TID, A-1500-TIDCV, A-2160, A-2460-T, A-2980-TDI, A-2980-TDICV, A-2980-TID, A-2980-TIDCV, GS-100, GS-102, GS-30, GS-43, GS-82, GS-82M, GS-83H, GS-83M		

condensators & interference suppression filters

operating capacitors

plastic



1

Part No.	365150	Ref. No.	2013003
description	operating capacitor capacity 20µF 425V tolerance 5% 50Hz ambient temperature max. -25 to +85°C ø 40mm L 70mm M8 plastic connection male faston 6.3mm 416.10.25 protection		
For models:	GS-18, GS-9		



1

Part No.	365012	Ref. No.	2013002
description	operating capacitor capacity 6.3µF 450V tolerance 5% 50Hz ambient temperature max. -25 to +85°C ø 30mm L 61mm M8 plastic connection male faston 6.3mm protection		
For models:	GS-1, GS-2, GS-3		

gas taps

PEL

21S series



1





Part No.	106523	Ref. No.	998026	
description	gas tap PEL type 21S gas inlet M16x1.5 (tube ø 10mm) bypass nozzle ø 0mm gas outlet M16x1.5 (tube ø 10/8mm) thermocouple connection M8x1 pilot connection M10x1 shaft ø 8x6.5mm shaft L 22/15mm shaft flat left			
spare parts for	106523			
	Part No.	101060	Ref. No.	—
	magnet unit standard L 39mm D1 ø 15.4mm D2 ø 11mm suitable for PEL20-21/JUNKERS/EGA			
	Part No.	101206	Ref. No.	—
	gas tap front part shaft ø 8x6.5mm shaft L 22/15mm shaft flat upper/lower suitable for PEL21			
	Part No.	101231	Ref. No.	—
	thermocouple nut T1: M9x1 T2: M18x1			
	Part No.	106202	Ref. No.	—
	bypass nozzle type PEL20/21 bore ø 0mm thread M5x0.5			

Table continues overleaf



accessories for		106523		
	Part No.	100908	Ref. No.	—
	union screw thread M10x1 for pipe ø 4mm Qty 1 pcs			
	Part No.	100909	Ref. No.	—
	union screw thread M10x1 for pipe ø 6mm Qty 1 pcs			
	Part No.	101246	Ref. No.	—
	olive for pipe ø 4mm Qty 1 pcs			
	Part No.	101278	Ref. No.	—
	olive for pipe ø 10mm Qty 1 pcs			
	Part No.	101286	Ref. No.	—
	olive ID ø 6mm Qty 1 pcs			
	Part No.	101300	Ref. No.	—
	union nut thread M16x1.5 tube ø 10mm			
	Part No.	101450	Ref. No.	—
	olive for pipe ø 8mm L 12.7mm Qty 1 pcs ED ø 10mm			
	Part No.	101451	Ref. No.	—
	union nut thread M16x1.5 tube ø 8mm			
	Part No.	110081	Ref. No.	—
	knob ø 70mm shaft ø 8x6.5mm shaft flat universal			
	Part No.	112206	Ref. No.	—
	knob dial plate silver gas tap PEL21/22/23 t.max.°C ED ø 63mm ID ø 45.5mm			

GAI

	1		
Part No.	106565	Ref. No.	998132
description	gas tap GAI gas inlet pipe flange ø30mm gas outlet 3/8" (tube ø 10mm) thermocouple connection M9x1 pilot connection M10x1 shaft ø 10x8mm shaft L 39/15mm shaft flat right		

	1		
Part No.	106506	Ref. No.	508005
description	gas tap GAI type G-1 ADB gas inlet pipe flange ø23mm bypass nozzle ø 0mm gas outlet 3/8" (tube ø 5mm) thermocouple connection 2x M8x1 pilot connection shaft ø 8x6.5mm shaft L 36/12mm shaft flat upper		



1

Part No.	106855	Ref. No.	578007
description	gas tap GAI type G-1 ASB-D gas inlet pipe flange ø23mm gas outlet M16x1.25 / M7x0.75 front fixing thermocouple connection M8x1 pilot connection shaft ø 8x6.5mm shaft L 36/12mm shaft flat upper tube ø 8mm		

gas thermostats

PEL

25ST series



1

Part No.	101332	Ref. No.	998130	
description	gas thermostat PEL type 25ST 120-320°C gas inlet M16x1.5 (tube ø 10mm) bypass nozzle ø 0mm gas outlet M16x1.5 (tube ø 10/8mm) thermocouple connection M9x1 pilot connection M10x1 capillary pipe 1200mm probe ø 6mm probe L 100mm shaft ø 8x6.5mm shaft L 21/15mm shaft flat upper			
accessories for	101332			
	Part No.	101060	Ref. No.	—
	magnet unit standard L 39mm D1 ø 15.4mm D2 ø 11mm suitable for PEL20-21/JUNKERS/EGA			
	Part No.	106191	Ref. No.	—
	bypass nozzle type PEL22 bore ø 0mm thread M6x0.5			
	Part No.	106200	Ref. No.	—
	nut thread M9x1 suitable for PEL 24/25S			
accessories for	101332			
	Part No.	101278	Ref. No.	—
	olive for pipe ø 10mm Qty 1 pcs			
	Part No.	101300	Ref. No.	—
	union nut thread M16x1.5 tube ø 10mm			
	Part No.	101450	Ref. No.	—
	olive for pipe ø 8mm L 12.7mm Qty 1 pcs ED ø 10mm			
	Part No.	101451	Ref. No.	—
	union nut thread M16x1.5 tube ø 8mm			
	Part No.	110079	Ref. No.	—
	knob dial plate gas thermostat 1-8 silver			
	Part No.	110081	Ref. No.	—
	knob ø 70mm shaft ø 8x6.5mm shaft flat universal			



gas valves and ignition boxes





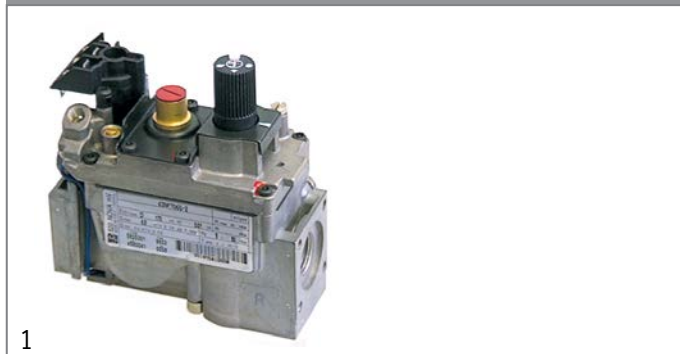

gas control valves

SIT

NOVASIT



1

Part No.	101187	Ref. No.	998161
description	gas valve SIT series Novasit 820 0.17VHz gas inlet 1/2" gas outlet 1/2" thermocouple connection M9x1 pilot connection M10x1 ignition pressure bar pressure range 5-50mbar pressure regulator connection blind equiv. no. 0.820.301 supply Operator millivolt		
spare parts for	101187		
	Part No.	101065	Ref. No. —
	magnet unit with cable L 44mm D1 ø 30mm D2 ø 20mm suitable for NOVASIT		
accessories for	101187		
	Part No.	100110	Ref. No. —
	pilot burner SIT type 190 series 3 flames nozzle ømm gas connectionmm		
	Part No.	101305	Ref. No. —
	gas connection straight 1/2" flange 45x45mm ELETROSIT/V4400/4600/4605 suitable for SIT/HONEYWELL hole distance 36x36mm		
	Part No.	101306	Ref. No. —
	gas connection angled flange 45x45mm hole distance 36x36mm 1/2" ELETROSIT/V4400/4600/4605 screw with O-ring suitable for SIT/HONEYWELL		
	Part No.	101307	Ref. No. —
	gas connection straight flange 45x45mm hole distance 36x36mm 3/4" ELETROSIT/V4400/4600/4605 screw with O-ring suitable for SIT/HONEYWELL		
	Part No.	101308	Ref. No. —
	gas connection angled flange 45x45mm hole distance 36x36mm 3/4" ELETROSIT/V4400/4600/4605 screw with O-ring suitable for SIT/HONEYWELL		
	Part No.	102116	Ref. No. —
	thermopile ROBERTSHAW L 900mm probe ø 9mm probe L 57mm 250-750mV screw connection 7/16"		

ignition parts

pilot burners

SIT

100 series

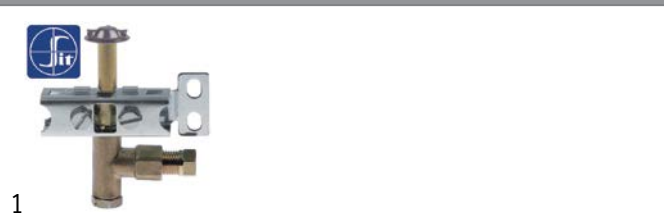

1

















Part No.	106906	Ref. No.	998137 998142
description	pilot burner SIT type 100 series 3 flames nozzle ø 0.2mm gas connection 6mm		
spare parts for	106906		
	Part No.	100245	Ref. No. —
	pilot burner nozzle LPG code 20 bore ø 0.2mm Qty 1 pcs thread M8x0.75		
	Part No.	100855	Ref. No. —
	pilot burner bracket triple		
	Part No.	100885	Ref. No. —
	air mixing sleeve for pilot burner Qty 1 pcs		
	Part No.	100916	Ref. No. —
	compression spring for pilot burner Qty 1 pcs		
	Part No.	100917	Ref. No. —
	gasket for pilot burner Qty 1 pcs aluminium		
	Part No.	100918	Ref. No. —
	screw for pilot burner		
	Part No.	107162	Ref. No. —
	pilot burner cap SIT 3 flames Hmm Lmm Qty 1 pcs		
	Part No.	107701	Ref. No. —
	pilot burner bottom part SIT 100 series nozzle ø 0.2mm		
accessories for	106906		
	Part No.	100245	Ref. No. —
	pilot burner nozzle LPG code 20 bore ø 0.2mm Qty 1 pcs thread M8x0.75		
	Part No.	100246	Ref. No. —
	pilot burner nozzle natural gas bore ø 0.35mm Qty 1 pcs thread M8x0.75		
	Part No.	100904	Ref. No. —
	locking screw M10x1 for pipe ø 4mm Qty 1 pcs		
	Part No.	100905	Ref. No. —
	locking screw M10x1 for pipe ø 6mm Qty 1 pcs		
	Part No.	102110	Ref. No. —
	pilot tube copper pipe ø 4mm thickness 1mm L 3000mm		
	Part No.	102111	Ref. No. —
	pilot tube copper pipe ø 6mm thickness 1mm L 3000mm		

Table continues overleaf















accessories for		106906	
Part No.	107171	Ref. No.	—
	pilot burner nozzle SIT natural/liquid gas bore ø 0.25mm Qty 1 pcs		
Part No.	107700	Ref. No.	—
	pilot burner bottom part SIT 100 series nozzle ø 0.25mm		
Part No.	107702	Ref. No.	—
	pilot burner bottom part SIT 100 series nozzle ø 0.35mm		

160 series



1



Part No.	100056	Ref. No.	998166
description	pilot burner SIT type 160 series 3 flames nozzle ømm gas connectionmm		
spare parts for	100056		
	Part No.	100907	Ref. No. —
	screw connection thread M10x1 Qty 1 pcs type SEF 1 ømm for thermocouple		
accessories for	100056		
	Part No.	100202	Ref. No. —
	pilot burner nozzle natural gas code 41 Qty 1 pcs nozzle ø 0.41mm		
	Part No.	100203	Ref. No. —
	pilot burner nozzle LPG code 25 Qty 1 pcs nozzle ø 0.25mm		
	Part No.	100701	Ref. No. —
	ignition electrode connection M4 Qty 1 pcs		
	Part No.	100801	Ref. No. —
	gasket for pilot burner Qty 1 pcs		
	Part No.	100869	Ref. No. —
	pilot burner nozzle natural gas code 51 Qty 1 pcs suitable for 160 series nozzle ø 0.51mm		
	Part No.	100870	Ref. No. 997048
	olive for pipe ø 4mm Qty 1 pcs suitable for 160 series for pilot burner		
	Part No.	100906	Ref. No. —
	screw connection thread M10x1 for ignition electrode brass Qty 1 pcs WS 10		
	Part No.	100908	Ref. No. —
	union screw thread M10x1 for pipe ø 4mm Qty 1 pcs		
	Part No.	100909	Ref. No. —
	union screw thread M10x1 for pipe ø 6mm Qty 1 pcs		
	Part No.	101287	Ref. No. —
	olive for pipe ø 6mm Qty 1 pcs		
	Part No.	102110	Ref. No. —
	pilot tube copper pipe ø 4mm thickness 1mm L 3000mm		
	Part No.	102111	Ref. No. —
	pilot tube copper pipe ø 6mm thickness 1mm L 3000mm		

accessories for		100056	
Part No.	107650	Ref. No.	—
	pilot burner nozzle SIT LPG code 30 Qty 1 pcs		

producer-specific pilot burners

JEMI



1

Part No.	106511	Ref. No.	998141
description	pilot burner 1 flame LPG code 0.2		



1

Part No.	106513	Ref. No.	990040
description	pilot burner 1 flame LPG code 0.2 M4x0.5		



1

Part No.	106509	Ref. No.	998177
description	pilot burner 1 flame natural gas code 0.4		



1

Part No.	106512	Ref. No.	990084
description	pilot burner 1 flame natural gas code 0.4		

1

Part No.	106507	Ref. No.	090036
description	pilot burner SIT type 100 series 3 flames LPG nozzle ϕ 0.21mm gas connection 4mm		



1

Part No.	106508	Ref. No.	090037
description	pilot burner SIT type 100 series 3 flames LPG nozzle ϕ 0.21mm gas connection 4mm		

electrodes



1

Part No.	106505	Ref. No.	210067
description	ignition electrode D1 ϕ 7mm D2 ϕ 8.5mm connection male faston 2.8mm L1 16mm BL1 18mm BL2 3mm BL3 23mm to clip		

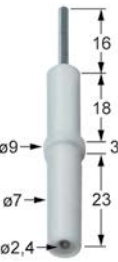

1

Part No.	102330	Ref. No.	210202
description	ignition electrode D1 ϕ 7mm D2 ϕ 9mm L1 16mm BL1 18mm BL2 3mm BL3 23mm to clip connection ϕ 2.4mm		



1

Part No.	100711	Ref. No.	210003
description	ignition electrode flange length 23mm flange width 15mm D1 ϕ 7mm L1 50mm BL1 25mm BL2 29mm connection F 2.8x0.8mm fixing dimensions ϕ 5x4mm with flange		

ignition cables

pre-assembled cables



1

Part No.	100014	Ref. No.	241116
description	ignition cable cable length 300mm connection ϕ 2.4mm / ϕ 2.4mm		

piezoelectric igniters

mounting diameter 18mm



1

Part No.	100009	Ref. No.	210075	
description	piezoelectric igniter body plastic blowing mounting ϕ 18mm connection ϕ 2.4mm front measurements 26mm M18x1.5			
accessories for	100009			
	Part No.	101339	Ref. No.	—
	cover cap for piezoelectric igniter			
	Part No.	106869	Ref. No.	—
	cover cap for piezoelectric igniter ID ϕ 22mm ED ϕ 35mm H 25mm			
	Part No.	107931	Ref. No.	—
	cover cap for piezoelectric igniter ID ϕ 21mm ED ϕ 36mm			



thermocouples

plug-in thermocouples

plug-in thermocouples standard

with barrel socket $\varnothing 6(6.5)$ mm

thermocouples SIT

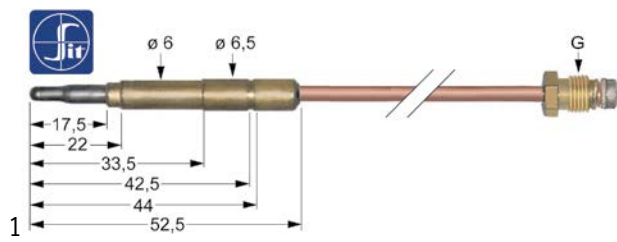

Part No.	107613	Ref. No.	998022
description	thermocouple SIT M9x1 L 1200mm plug connection $\varnothing 6.0(6.5)$ mm		

gas burners

hob burners

producer-specific hob burners

JEMI

universal



Part No.	104270	Ref. No.	990909 999035
description	air mixing tube $\varnothing 19$ mm		



Part No.	104248	Ref. No.	990405
description	burner cap $\varnothing 125$ mm		



Part No.	104670	Ref. No.	998216
description	burner cap $\varnothing 150$ mm		
accessories for	104670		
	Part No.	104669	Ref. No. 998208
	burner head for burner cap $\varnothing 150$ mm		



Part No.	104671	Ref. No.	998218
description	burner cap $\varnothing 150$ mm		
accessories for	104671		
	Part No.	104669	Ref. No. 998208
	burner head for burner cap $\varnothing 150$ mm		



Part No.	104249	Ref. No.	590406
description	burner cap $\varnothing 155$ mm		
accessories for	104249		
	Part No.	104239	Ref. No. 590404
	burner head for burner cap $\varnothing 155$ mm		





Part No.	104237	Ref. No.	590403
description	burner head for burner cap $\varnothing 125$ mm		





Part No.	104238	Ref. No.	070414
description	burner head for burner cap $\varnothing 125$ mm		



Part No.	104669	Ref. No.	998208
description	burner head for burner cap $\varnothing 150$ mm		
accessories for	104669		
	Part No.	104670	Ref. No. 998216
	burner cap $\varnothing 150$ mm		
	Part No.	104671	Ref. No. 998218
	burner cap $\varnothing 150$ mm		



			
1			
Part No.	104239	Ref. No.	590404
description	burner head for burner cap ø 155mm		
accessories for	104239		
	Part No.	Ref. No.	
	104249	590406	
	 burner cap ø 155mm		

gas nozzles

pilot burner nozzles

pilot burner nozzles SIT

160 series

			
1			
Part No.	107175	Ref. No.	998168
description	pilot burner nozzle SIT natural gas code 51 Qty 1 pcs suitable for 160 series		

auxiliary gas parts

screw connections

olives

			
1			
Part No.	100870	Ref. No.	997048
description	olive for pipe ø 4mm Qty 1 pcs suitable for 160 series for pilot burner		

equipment-specific units

for dishwashers

drain and intake components

JEMI

drain /intake bodies

			
1			
Part No.	502074	Ref. No.	1009020
description	drain fitting ID ø 37mm L 58mm hose ø 28mm with nut		
For models:	GS-1, GS-100, GS-18, GS-19, GS-2, GS-3, GS-30, GS-4-2, GS-4-2AF, GS-43, GS-6, GS-6AF, GS-82, GS-8-2, GS-82M, GS-9		

			
1			
Part No.	506240	Ref. No.	2510168
description	flat gasket rubber ED ø 56mm ID ø 47mm thickness 2mm Qty 1 pcs		
For models:	A-2980-TDI, A-2980-TDICV, A-2980-TID, A-2980-TIDCV, GS-1, GS-18, GS-19, GS-2, GS-3, GS-4-2, GS-4-2AF, GS-6, GS-6AF, GS-8-2, GS-9		

			
1			
Part No.	511556	Ref. No.	2510325
description	gasket rubber ED ø 142mm ID ø 112mm thickness 3mm Qty 1 pcs		
For models:	A-1200DI, A-1200DICV, A-1200ID, A-1200IDCV, A-1500-TDI, A-1500-TDICV, A-1500-TID, A-1500-TIDCV, A-2980-TDI, A-2980-TDICV, A-2980-TID, A-2980-TIDCV, GS-102, GS-16, GS-18, GS-19, GS-20, GS-5AF, GS-7, GS-83H, GS-83M		

			
1			
Part No.	524994	Ref. No.	1014270
description	inlet valve ø 57mm H 55mm hose ø 45mm		
For models:	GS-1, GS-18, GS-19, GS-2, GS-3, GS-4-2, GS-4-2AF, GS-6, GS-6AF, GS-8-2, GS-9		
spare parts for	524994		
	Part No.	Ref. No.	
	506240	2510168	
	 flat gasket rubber ED ø 56mm ID ø 47mm thickness 2mm Qty 1 pcs		

			
1			
Part No.	511974	Ref. No.	1009254
description	intake body ED ø 150mm outlet ø 36 H 150mm		
For models:	A-1200DI, A-1200DICV, A-1200ID, A-1200IDCV, A-1500-TDI, A-1500-TDICV, A-1500-TID, A-1500-TIDCV, A-2980-TDI, A-2980-TDICV, A-2980-TID, A-2980-TIDCV, GS-102, GS-83H, GS-83M		

			
1			
Part No.	511555	Ref. No.	1009257
description	intake/drain body ED ø 150mm ID ø 100mm hose ø 45/30mm		
For models:	GS-16, GS-18, GS-19, GS-20, GS-5AF, GS-7		



filters



1

Part No.	511554	Ref. No.	0522119
description	combi filter ø 130mm H 60mm		
For models:	GS-16, GS-18, GS-19, GS-20, GS-5AF, GS-7		



1

Part No.	511975	Ref. No.	0522080
description	round filters ø 125mm H 59mm SS		
For models:	GS-19, GS-8-2, GS-9		

overflow pipes



1

Part No.	502075	Ref. No.	1016003
description	overflow pipe L 113mm ø 37mm		
For models:	GS-1, GS-18, GS-19, GS-2, GS-3, GS-4-2, GS-4-2AF, GS-6, GS-6AF, GS-8-2, GS-9		



1

Part No.	511553	Ref. No.	1016119
description	overflow pipe L 200mm ø 37mm		
For models:	GS-16, GS-18, GS-19, GS-20, GS-5AF		



1

Part No.	694946	Ref. No.	1016101
description	overflow pipe L 235mm with chain ø 35mm		
For models:	A-2160, A-2460-T, MA-MC		



1

Part No.	507530	Ref. No.	1016083
description	overflow pipe L 500mm ø 37mm		
For models:	A-2980-TDI, A-2980-TDICV, A-2980-TID, A-2980-TIDCV, GS-102, GS-83H, GS-83M		

boilers

boilers for dishwashers



1

Part No.	524984	Ref. No.	1405091
description	boiler left 12000W ø 180mm L 500mm inlet ø 1/2" ET		
For models:	A-2980-TDI, A-2980-TDICV, A-2980-TID, A-2980-TIDCV, MA-MC		



1

Part No.	524983	Ref. No.	0502083
description	boiler ø 135mm L 465mm inlet ø 11		
For models:	GS-102, GS-83H, GS-83M		



1

Part No.	524985	Ref. No.	1405092
description	boiler right 12000W ø 180mm L 500mm inlet ø 1/2" ET		
For models:	A-2980-TDI, A-2980-TDICV, A-2980-TID, A-2980-TIDCV, MA-MC		

softener cartridges

softening columns



1

Part No.	530065	Ref. No.	1024001
description	softener 4-fold L 380mm W 180mm		
For models:	GS-18, GS-19, GS-2, GS-20, GS-3, GS-4-2, GS-4-2AF, GS-6, GS-6AF, GS-7, GS-8-2, GS-9		



hood mechanics for dishwashers

springs



1

Part No.	531212	Ref. No.	2521082
description	compression spring \varnothing 19mm L 33mm wire gauge \varnothing 3mm steel		
For models:	GS-82M		

air traps



1

Part No.	518435	Ref. No.	4055001
description	air trap L 80mm W 36mm \varnothing 25mm H 68mm thread 3/4" hose \varnothing 7mm plastic		
For models:	A-1200, A-1200DI, A-1200DICV, A-1200ID, A-1200IDCV, A-1500-T, A-1500-TDI, A-1500-TDICV, A-1500-TID, A-1500-TIDCV, A-2160, A-2460-T, A-2980-TDI, A-2980-TDICV, A-2980-TID, A-2980-TIDCV, GS-100, GS-102, GS-16, GS-18, GS-19, GS-2, GS-20, GS-3, GS-30, GS-4-2, GS-4-2AF, GS-43, GS-5AF, GS-6, GS-6AF, GS-7, GS-80, GS-82, GS-8-2, GS-82M, GS-83H, GS-83M, GS-9, MA-MC		

door mechanics



1

Part No.	524518	Ref. No.	2521120
description	tension spring \varnothing 10mm wire gauge \varnothing 2mm total length 125mm for door mechanism		
For models:	GS-18, GS-19, GS-20, GS-6, GS-6AF, GS-7		

door guides



1

Part No.	524828	Ref. No.	4038019
description	guide L 50mm W 10mm H 6mm for dishwasher JEMI		
For models:	GS-18, GS-19, GS-2, GS-20, GS-6, GS-6AF, GS-7		

locks



1

Part No.	508417	Ref. No.	0814030
description	door opener model GS-30 JEMI		
For models:	GS-30		

washing and rinsing systems





1

Part No.	524516	Ref. No.	4047001
description	bearing for rinse arm \varnothing 26mm H 34.5mm		
For models:	GS-30, GS-4-2, GS-4-2AF, GS-43, GS-82, GS-82M, GS-83H, GS-83M		



1

Part No.	524530	Ref. No.	4050119
description	bush for wash arm mounting pos. upper/lower \varnothing 37mm H 27mm thread 3/4" with gasket		
For models:	A-1200DI, A-1200DICV, A-1200ID, A-1200IDCV, A-1500-TDI, A-1500-TDICV, A-1500-TID, A-1500-TIDCV, A-2980-TDI, A-2980-TDICV, A-2980-TID, A-2980-TIDCV, GS-1, GS-102, GS-16, GS-18, GS-19, GS-2, GS-20, GS-3, GS-30, GS-5AF, GS-6, GS-6AF, GS-7, GS-82, GS-82M, GS-83H, GS-83M, GSP-45, GSP-46, MA-MC		
spare parts for	524530		
	Part No.	Ref. No.	2514090
		O-ring EPDM thickness 2.5mm ID \varnothing 28mm Qty 1 pcs	



1

Part No.	524993	Ref. No.	4030002
description	end cap for wash distributor thickness 19mm ED \varnothing 63mm		
For models:	A-1200DI, A-1200DICV, A-1200ID, A-1200IDCV, A-1500-TDI, A-1500-TDICV, A-1500-TID, A-1500-TIDCV, A-2980-TDI, A-2980-TDICV, A-2980-TID, A-2980-TIDCV, GS-18, GS-19, GS-20, GS-30, GS-4-2, GS-4-2AF, GS-43, GS-6, GS-6AF, GS-7, GS-8-2, GS-83H, GS-83M, GS-9, MA-MC		



1

Part No.	506239	Ref. No.	2510020
description	flat gasket rubber ED \varnothing 35.5mm ID \varnothing 24mm thickness 4mm Qty 1 pcs		
For models:	GS-1, GS-102, GS-2, GS-3, GS-4-2, GS-4-2AF, GS-6, GS-6AF, GS-8-2, GS-83H, GS-83M, GS-9, MA-MC		



1



Part No.	524517	Ref. No.	1515608
description	screw internal hexagon thread M10x1 thread L 10mm WS 6 for rinse arm		
For models:	GS-1, GS-102, GS-16, GS-18, GS-19, GS-2, GS-20, GS-3, GS-30, GS-4-2, GS-4-2AF, GS-43, GS-5AF, GS-6, GS-6AF, GS-7, GS-82, GS-8-2, GS-82M, GS-83H, GS-83M, GS-9, GSP-45, GSP-46		

1



Part No.	518436	Ref. No.	4047002
description	screw connection thread 1/2" thread L 8mm WS 23 for rinse arm		
For models:	GS-1, GS-102, GS-16, GS-18, GS-19, GS-2, GS-20, GS-5AF, GS-6, GS-6AF, GS-7, GS-8-2, GS-83H, GS-83M, GS-9, GSP-45, GSP-46		

1



Part No.	524990	Ref. No.	4035051
description	wash distributor mounting pos. lower ø 48mm L 425mm plastic		
For models:	GS-18, GS-19, GS-20, GS-30, GS-4-2AF, GS-6AF, GS-7, GS-8-2, GS-9		
spare parts for	524990		
	Part No.	524993	Ref. No. 4030002
	end cap for wash distributor thickness 19mm ED ø 63mm		

washing and rinsing systems (sorted by producer)

JEMI

1



Part No.	524989	Ref. No.	8040014
description	wash arm complete mounting pos. upper/lower L 545mm W 42mm H 44mm nozzles 6		
For models:	GS-100, GS-80		

1



Part No.	511568	Ref. No.	8040001
description	wash arm L 360mm W 28mm H 45mm nozzles 4		
For models:	GS-3		

1



Part No.	511569	Ref. No.	8040002
description	wash arm L 363mm W 55mm H 45mm nozzles 4		
For models:	GS-8-2		

1



Part No.	502032	Ref. No.	2521268
description	D-lock		
For models:	A-1200, A-1500-T, A-2160, A-2460-T, GS-100, GS-3, GS-4-2, GS-4-2AF, GS-80, GS-8-2, GS-9, MA-MC		

1



Part No.	502034	Ref. No.	2521248
description	D-lock		
For models:	GS-100, GS-4-2, GS-4-2AF, GS-80, GS-8-2, GS-9		

1



Part No.	511570	Ref. No.	4033002 4033002+4032001+4051001
description	end piece for wash arm L 112mm W 22mm H 47mm nozzles 1		
For models:	GS-100, GS-80, GS-8-2		

1





Part No.	511572	Ref. No.	2514130
description	O-ring EPDM thickness 4.5mm ID ø 25mm Qty 1 pcs		
For models:	A-1200, A-1500-T, A-2160, A-2460-T, GS-100, GS-3, GS-4-2, GS-4-2AF, GS-80, GS-8-2, GS-9, GSP-45, MA-MC		









			
1			
Part No.	511956	Ref. No.	4051001
description	wash jet body 2 bores thread M20x1.75		
For models:	GS-100, GS-4-2AF, GS-80		



			
1			
Part No.	511957	Ref. No.	4051003
description	wash jet body helix form thread M20x1.75		
For models:	GS-3, GS-4-2AF, GS-43, GS-8-2, GS-9, GSP-45, GSP-46		

			
1			
Part No.	511958	Ref. No.	4032001
description	wash jet cap hole ø 5mm thread M20x1.75		
For models:	GS-100, GS-3, GS-4-2AF, GS-8-2, GS-9		

			
1			
Part No.	524872	Ref. No.	8040103
description	wash arm L 348mm W 37mm H 44mm nozzles 4		
For models:	GS-1, GS-2, GS-3		

			
1			
Part No.	524528	Ref. No.	8040183
description	wash arm L 570mm nozzles 6 mounting ø 32mm mounting pos. upper/lower H 44mm W 37mm		
For models:	GS-102, GS-83H, GS-83M		
spare parts for	524528		
	Part No.	Ref. No.	
	511466	4032122	
description	swirl hole ø 2.5mm H 11mm ø 17mm		
	Part No.	Ref. No.	
	511976	4032119	
description	wash jet mounting pos. upper/lower thread 1/2" H 12mm WS 25		
accessories for	524528		
	Part No.	Ref. No.	
	524529	4050120	
description	wash arm support mounting pos. upper/lower ø 49mm H 28mm		
	Part No.	Ref. No.	
	524530	4050119	
description	bush for wash arm mounting pos. upper/lower ø 37mm H 27mm thread 3/4" with gasket		

			
1			
Part No.	524986	Ref. No.	8040119
description	wash arm mounting pos. upper/lower L 500mm W 38mm H 44mm nozzles 6		
For models:	GS-102, GS-16, GS-18, GS-19, GS-20, GS-30, GS-7, GS-83H, GS-83M		

			
1			
Part No.	524987	Ref. No.	8040182
description	wash arm mounting pos. upper/lower L 550mm W 38mm H 44mm nozzles 6		
For models:	GS-82, GS-82M		
spare parts for	524987		
	Part No.	Ref. No.	
	511976	4032119	
description	wash jet mounting pos. upper/lower thread 1/2" H 12mm WS 25		



			
1			
Part No.	524988	Ref. No.	4028183
description	wash arm mounting pos. upper/lower L 570mm W 37mm H 41mm nozzles 6		
For models:	A-1200DI, A-1200DICV, A-1200ID, A-1200IDCV, A-1500-TDI, A-1500-TDICV, A-1500-TID, A-1500-TIDCV, A-2980-TDI, A-2980-TDICV, A-2980-TID, A-2980-TIDCV, GS-102, GS-83H, GS-83M		



			
1			
Part No.	511466	Ref. No.	4032122
description	swirl hole ø 2.5mm H 11mm ø 17mm		
For models:	GS-1, GS-102, GS-16, GS-18, GS-19, GS-2, GS-20, GS-3, GS-30, GS-5AF, GS-6, GS-6AF, GS-7, GS-82, GS-82M, GS-83H, GS-83M		

			
1			
Part No.	511976	Ref. No.	4032119
description	wash jet mounting pos. upper/lower thread 1/2" H 12mm WS 25		
For models:	GS-1, GS-102, GS-16, GS-18, GS-19, GS-2, GS-20, GS-3, GS-30, GS-5AF, GS-6, GS-6AF, GS-7, GS-82, GS-82M, GS-83H, GS-83M		





			
1			
Part No.	531316	Ref. No.	0807083
description	rinse arm L 530mm mounting pos. lower r. jets 8 1/2"		
For models:	GS-102, GS-83H, GS-83M		

			
1			
Part No.	524992	Ref. No.	0807001
description	rinse arm mounting pos. lower L 370mm nozzles 4 1/2"		
For models:	GS-4-2, GS-4-2AF, GS-6, GS-6AF		
spare parts for	524992		
	Part No.	518436	Ref. No. 4047002
	screw connection thread 1/2" thread L 8mm WS 23 for rinse arm		

			
1			
Part No.	524991	Ref. No.	0807004
description	rinse arm mounting pos. lower L 420mm nozzles 8 1/2"		
For models:	GS-18, GS-19, GS-8-2, GS-9		
spare parts for	524991		
	Part No.	518436	Ref. No. 4047002
	screw connection thread 1/2" thread L 8mm WS 23 for rinse arm		

			
1			
Part No.	531318	Ref. No.	0841040
description	rinse jet thread M6 thread L 6.5mm stainless steel WS M10		
For models:	A-1200DI, A-1200DICV, A-1200ID, A-1200IDCV, A-1500-TDI, A-1500-TDICV, A-1500-TID, A-1500-TIDCV, A-2980-TDI, A-2980-TDICV, A-2980-TID, A-2980-TIDCV, GS-1, GS-102, GS-16, GS-18, GS-19, GS-2, GS-20, GS-3, GS-30, GS-4-2, GS-4-2AF, GS-43, GS-5AF, GS-6, GS-6AF, GS-7, GS-82, GS-8-2, GS-82M, GS-83H, GS-83M, GS-9		

			
1			
Part No.	524531	Ref. No.	0843007
description	rinse jet mounting pos. upper/lower ø 14mm H 21mm thread M11x1		
For models:	GS-1, GS-100, GS-102, GS-16, GS-18, GS-19, GS-2, GS-20, GS-30, GS-5AF, GS-6, GS-6AF, GS-7, GS-82, GS-82M, GS-83H, GS-83M, GSP-45, GSP-46		

			
1			
Part No.	524532	Ref. No.	0832006
description	swirl for rinse jet mounting pos. upper/lower H 16mm ø 8mm 2.4mm		
For models:	GS-1, GS-100, GS-102, GS-16, GS-18, GS-19, GS-2, GS-20, GS-30, GS-43, GS-5AF, GS-6, GS-6AF, GS-7, GS-82, GS-82M, GS-83H, GS-83M, GSP-45, GSP-46		

			
1			
Part No.	531317	Ref. No.	4034102
description	wash jet ø 23mm L 54mm bore ø 6x12mm 1/2"		
For models:	A-1200, A-1500-T, A-2160, A-2460-T		

			
1			
Part No.	531320	Ref. No.	4033120
description	end piece thread 1/2" ø 12.5mm L 42mm		
For models:	A-1200DI, A-1200DICV, A-1200ID, A-1200IDCV, A-1500-TDI, A-1500-TDICV, A-1500-TID, A-1500-TIDCV, A-2980-TDI, A-2980-TDICV, A-2980-TID, A-2980-TIDCV, GS-102, GS-82, GS-82M, GS-83H, GS-83M		

			
1			
Part No.	524529	Ref. No.	4050120
description	wash arm support mounting pos. upper/lower ø 49mm H 28mm		
For models:	A-1200DI, A-1200DICV, A-1200ID, A-1200IDCV, A-1500-TDI, A-1500-TDICV, A-1500-TID, A-1500-TIDCV, A-2980-TDI, A-2980-TDICV, A-2980-TID, A-2980-TIDCV, GS-1, GS-102, GS-16, GS-18, GS-19, GS-2, GS-20, GS-3, GS-30, GS-5AF, GS-6, GS-6AF, GS-7, GS-82, GS-82M, GS-83H, GS-83M, GSP-46, MA-MC		

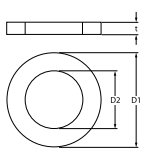

			
1			
Part No.	531319	Ref. No.	4080183
description	wash arm support ø 20mm H 20mm L 35mm		
For models:	GS-102, GS-16, GS-18, GS-19, GS-20, GS-30, GS-7, GS-83H, GS-83M		

			
1			
Part No.	511572	Ref. No.	2514130
description	O-ring EPDM thickness 4.5mm ID ø 25mm Qty 1 pcs		
For models:	A-1200, A-1500-T, A-2160, A-2460-T, GS-100, GS-3, GS-4-2, GS-4-2AF, GS-80, GS-8-2, GS-9, GSP-45, MA-MC		

handles and hand wheels

accessories

end caps

			
1			
Part No.	518077	Ref. No.	4030021
description	end cap oval ø 15x42mm		
For models:	GS-18, GS-19, GS-3, GS-6, GS-6AF		

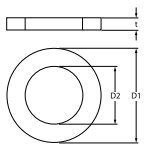
			
1			
Part No.	532732	Ref. No.	2514142
description	O-ring EPDM thickness 4mm ID ø 42mm Qty 1 pcs		
For models:	A-1200DI, A-1200DICV, A-1200ID, A-1200IDCV, A-1500-TDI, A-1500-TDICV, A-1500-TID, A-1500-TIDCV, A-2980-TDI, A-2980-TDICV, A-2980-TID, A-2980-TIDCV, GS-18, GS-19, GS-20, GS-4-2, GS-4-2AF, GS-6, GS-6AF, GS-7, GS-8-2, GS-83H, GS-83M, GS-9, MA-MC		

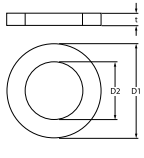
			
1			
Part No.	510408	Ref. No.	2514180
description	O-ring EPDM thickness 5.34mm ID ø 47mm Qty 1 pcs		
For models:	A-1200, A-1200DI, A-1200DICV, A-1200ID, A-1200IDCV, A-1500-T, A-1500-TDI, A-1500-TDICV, A-1500-TID, A-1500-TIDCV, A-2160, A-2460-T, A-2980-TDI, A-2980-TDICV, A-2980-TID, A-2980-TIDCV, GS-1, GS-100, GS-102, GS-16, GS-18, GS-19, GS-2, GS-20, GS-3, GS-30, GS-4-2, GS-4-2AF, GS-43, GS-5AF, GS-6, GS-6AF, GS-7, GS-80, GS-82, GS-8-2, GS-82M, GS-83H, GS-83M, GS-9, GSP-45, GSP-46, MA-MC		

hinges

oven hinges

			
1			
Part No.	694397 ¹	Ref. No.	920600
description	oven hinge mounting distance 173mm lug mounting 14mm lever length 117mm groove distance 9mm spring thickness 3.5mm mounting ear position left/right spring length 113mm L 206mm W 26mm with opposite support		

¹with opposite support

sealing washers

fibre gaskets

			
1			
Part No.	506237	Ref. No.	2511187
description	flat gasket FIBER ED ø 28mm ID ø 21mm thickness 2mm Qty 1 pcs		
For models:	GS-102, GS-18, GS-19, GS-2, GS-20, GS-6, GS-6AF, GS-7, GS-83H, GS-83M, GSP-45, GSP-46		

gaskets

O-rings

EPDM

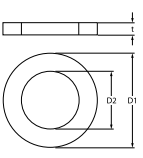
			
1			
Part No.	532621	Ref. No.	2514090
description	O-ring EPDM thickness 2.5mm ID ø 28mm Qty 1 pcs		
For models:	GS-102, GS-18, GS-19, GS-2, GS-20, GS-3, GS-30, GS-6, GS-6AF, GS-7, GS-82, GS-82M, GS-83H, GS-83M, MA-MC		

			
1			
Part No.	524898	Ref. No.	2411121 2511121
description	flat gasket FIBER ED ø 35mm ID ø 22mm thickness 2mm Qty 1 pcs		
For models:	GS-102, GS-18, GS-19, GS-2, GS-20, GS-6, GS-6AF, GS-7, GS-83H, GS-83M, GSP-45, GSP-46		





			
1			
Part No.	506238	Ref. No.	2511250
description	flat gasket FIBER ED ø 38mm ID ø 32mm thickness 2mm Qty 1 pcs		
For models:	MA-MC		

rubber gaskets			
			
1			
Part No.	506239	Ref. No.	2510020
description	flat gasket rubber ED ø 35.5mm ID ø 24mm thickness 4mm Qty 1 pcs		
For models:	GS-1, GS-102, GS-2, GS-3, GS-4-2, GS-4-2AF, GS-6, GS-6AF, GS-8-2, GS-83H, GS-83M, GS-9, MA-MC		

			
1			
Part No.	506240	Ref. No.	2510168
description	flat gasket rubber ED ø 56mm ID ø 47mm thickness 2mm Qty 1 pcs		
For models:	A-2980-TDI, A-2980-TDICV, A-2980-TID, A-2980-TIDCV, GS-1, GS-18, GS-19, GS-2, GS-3, GS-4-2, GS-4-2AF, GS-6, GS-6AF, GS-8-2, GS-9		

			
1			
Part No.	511556	Ref. No.	2510325
description	gasket rubber ED ø 142mm ID ø 112mm thickness 3mm Qty 1 pcs		
For models:	A-1200DI, A-1200DICV, A-1200ID, A-1200IDCV, A-1500-TDI, A-1500-TDICV, A-1500-TID, A-1500-TIDCV, A-2980-TDI, A-2980-TDICV, A-2980-TID, A-2980-TIDCV, GS-102, GS-16, GS-18, GS-19, GS-20, GS-5AF, GS-7, GS-83H, GS-83M		

			
1			
Part No.	560631	Ref. No.	2510012
description	gasket rubber ED ø 19mm ID ø 10mm thickness 2mm Qty 1 pcs		
For models:	A-1200DI, A-1200DICV, A-1200ID, A-1200IDCV, A-1500-TDI, A-1500-TDICV, A-1500-TID, A-1500-TIDCV, A-2980-TDI, A-2980-TDICV, A-2980-TID, A-2980-TIDCV, GS-1, GS-100, GS-102, GS-83H, GS-83M, GSP-46		

			
1			
Part No.	560632	Ref. No.	2510145
description	gasket rubber ED ø 57mm ID ø 42mm thickness 2mm Qty 1 pcs white		
For models:	A-1200, A-1500-T, A-2160, A-2460-T, GS-1, GS-100, GS-18, GS-19, GS-2, GS-3, GS-30, GS-4-2, GS-4-2AF, GS-43, GS-6, GS-6AF, GS-80, GS-82, GS-8-2, GS-82M, GS-9, MA-MC		

springs

compression springs

			
1			
Part No.	531212	Ref. No.	2521082
description	compression spring ø 19mm L 33mm wire gauge ø 3mm steel		
For models:	GS-82M		

tension springs







			
1			
Part No.	524518	Ref. No.	2521120
description	tension spring ø 10mm wire gauge ø 2mm total length 125mm for door mechanism		
For models:	GS-18, GS-19, GS-20, GS-6, GS-6AF, GS-7		

dosing pumps

membrane dosing pumps

electric dosing pumps

Delta

			
1			
Part No.	361003	Ref. No.	2031001
description	dosing pump 220V rinse aid duty cycle 25% type EL-1 valve lip valve		
For models:	GS-100, GS-18, GS-19, GS-3, GS-30, GS-4-2, GS-4-2AF, GS-80, GS-82, GS-8-2, GS-82M, GS-83H, GS-83M, GS-9, GSP-45, GSP-46		
spare parts for	361003		
	Part No.	361122	Ref. No.
			—
		lip valve type DELTA	
	Part No.	361123	Ref. No.
			—
		membrane type DELTA	
	Part No.	361169	Ref. No.
			—
		hose connector type DELTA	
	Part No.	361188	Ref. No.
			—
		disc type DELTA	
	Part No.	361319	Ref. No.
			—
		flat gasket rubber ID ø 9mm ED ø 14.5mm thickness 1mm type DELTA	





self-priming

various



1

Part No.	361370	Ref. No.	2031101
description	dosing pump type model 2 rinse aid inlet 4x6mm outlet 4x6mm pressure connection ø 4x6mm suction connection ø 4x6mm		
For models:	GS-1, GS-102, GS-16, GS-18, GS-19, GS-2, GS-20, GS-3, GS-30, GS-5AF, GS-6, GS-6AF, GS-7, GS-83H, GS-83M		
spare parts for	361370		
	Part No.	361307	Ref. No. —
	membrane dosing pump ø 68mm hole ø 6mm for type DIB3P/DIB5P		
	Part No.	361459	Ref. No. —
	hose connector ø 6mm for dosing pump		

hoses

drain hoses

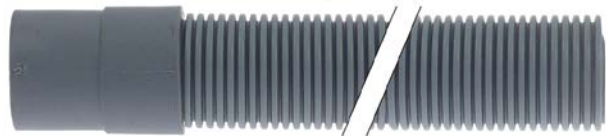

1

Part No.	517825	Ref. No.	1010291
description	drain hose DN28 L 1500mm straight ø inside 28mm straight ext. ø 35mm outer hose ø 33mm		
For models:	A-1200, A-1500-T, A-2160, A-2460-T, GS-100, GS-16, GS-18, GS-19, GS-2, GS-20, GS-3, GS-30, GS-4-2, GS-4-2AF, GS-43, GS-5AF, GS-6, GS-6AF, GS-7, GS-82, GS-8-2, GS-82M, GS-83H, GS-83M, GS-9, GSP-46, MA-MC		

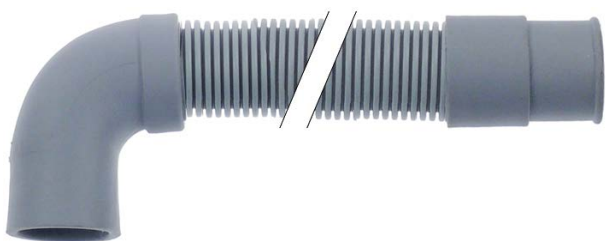

1

Part No.	518600	Ref. No.	1010292
description	drain hose DN19 L 1500mm straight ø inside 19mm straight ext. ø 24mm elbow ø inside 22mm elbow ext. ø 27mm outer hose ø 24mm		
For models:	GS-18, GS-19, GS-2, GS-20, GS-3, GS-30, GS-4-2, GS-4-2AF, GS-43, GS-6, GS-6AF, GS-7, GS-8-2, GS-83H, GS-83M, GS-9		

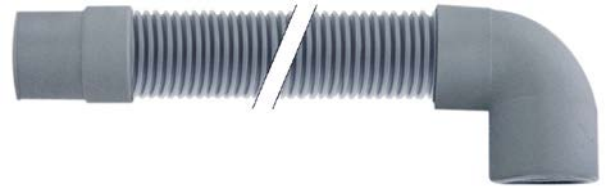

1

Part No.	530571	Ref. No.	1010294
description	drain hose DN24 L 1500mm straight ø inside 24mm straight ext. ø 29mm elbow ø inside 29mm elbow ext. ø 35mm outer hose ø 28mm		
For models:	GS-1, GS-18, GS-19, GS-2, GS-20, GS-3, GS-30, GS-4-2, GS-4-2AF, GS-43, GS-6, GS-6AF, GS-7, GS-8-2, GS-9		

measuring equipment

thermometers

built-in thermometers

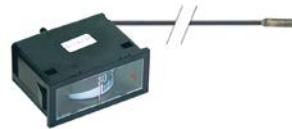

1

Part No.	541063	Ref. No.	2028022
description	thermometer mounting measurements 58x25.5mm 0 up to +120°C capillary pipe 1500mm probe ø 6.5mm probe L 23mm		
For models:	A-1200, A-1500-T, A-2160, A-2460-T, GS-100, GSP-45, GSP-46		



1

Part No.	541305	Ref. No.	2028016
description	thermometer mounting measurements 62x11mm +20 up to +120°C capillary pipe 1500mm probe ø 6.5mm probe L 16mm		
For models:	GS-18, GS-19, GS-20, GS-30, GS-43, GS-6AF, GS-7, GS-82, GS-82M, GS-83H, GS-83M		

GASTROPARTS.COM

