



**GASTROPARTS**

# Grimac

- [EN]** Equipment
- [DE]** Geräte
- [ES]** Aparatos
- [FR]** Équipement
- [IT]** Attrezzature
- [PL]** Urządzenia
- [RU]** Оборудование

✉ [gastroparts@gastroparts.com](mailto:gastroparts@gastroparts.com)

☎ +48 56 657 00 66

📘 [fb.com/gastroparts.global](https://fb.com/gastroparts.global)









**GASTROPARTS.COM**











# heating elements



## heating elements for coffee machine



 <p>1</p>			
<b>Part No.</b>	417026	<b>Ref. No.</b>	SM132
<b>description</b>	heating element 1000W 230V heating circuits 1 L 205mm W 50mm H 18mm L1 30mm L2 35mm L3 140mm mounting distance 28mm thread M10x1 connection M3 tube ø 8.5mm 2 hole fixing immersion heater windings 2		
<b>accessories for</b>	417026		
	<b>Part No.</b>	510416	<b>Ref. No.</b> —
	flat gasket fibre ED ø 19mm ID ø 10.5mm thickness 1.5mm for thread M10 Qty 1 pcs		
	<b>Part No.</b>	510893	<b>Ref. No.</b> —
	O-ring EPDM thickness 2.62mm ID ø 9.92mm Qty 1 pcs		
	<b>Part No.</b>	520231	<b>Ref. No.</b> —
	nut thread M10x1 H 6mm WS 14 zinc-coated steel Qty 1 pcs		
	<b>Part No.</b>	521129	<b>Ref. No.</b> —
	nut thread M10 H 6mm SS WS 17 Qty 1 pcs DIN/ISO DIN 439		
	<b>Part No.</b>	527169	<b>Ref. No.</b> —
	hexagonal nut thread M3 H 2.8mm WS 5.5 brass Qty 1 pcs		
	<b>Part No.</b>	560110	<b>Ref. No.</b> —
	plain washer ID ø 3.2mm ED ø 7mm thickness 0.5mm SS Qty 20 pcs DIN 125A for thread M3		
	<b>Part No.</b>	560130	<b>Ref. No.</b> —
	hexagonal nut thread M3 H 2.4mm WS 5.5 SS DIN/ISO DIN 934 / ISO 4032/8673 Qty 20 pcs		

 <p>1</p>			
<b>Part No.</b>	417027	<b>Ref. No.</b>	SM130
<b>description</b>	heating element 1250W 220V heating circuits 1 L 370mm H 70mm L1 32mm L2 58mm L3 280mm mounting distance 25mm thread M10x1 connection M3x0.6 2 hole fixing immersion heater		

 <p>1</p>			
<b>Part No.</b>	417014	<b>Ref. No.</b>	C405
<b>description</b>	heating element 1300W 230V heating circuits 1 hole distance 59mm L 185mm W 40mm H 18mm hole ø 9mm tube ø 8.5mm connection male faston 6.3mm immersion heater 3 hole flange suitable for CIMBALI		
<b>accessories for</b>	417014		
	<b>Part No.</b>	529484	<b>Ref. No.</b> —
	flat gasket fibre ED ø 58mm ID ø 50mm thickness 2mm Qty 1 pcs		

 <p>1</p>			
<b>Part No.</b>	417006	<b>Ref. No.</b>	1240100216 W902
<b>description</b>	heating element 1300W 230V heating circuits 1 thread 1¼" L 110mm W 27mm H 30mm tube ø 6.4mm connection male faston 6.3mm immersion heater connection length 30mm flange with thread WS 37 with thread for safety thermostat		
<b>accessories for</b>	417006		
	<b>Part No.</b>	510405	<b>Ref. No.</b> —
	flat gasket fibre ED ø 56mm ID ø 42mm thickness 2mm for thread 1¼" Qty 1 pcs		
	<b>Part No.</b>	528021	<b>Ref. No.</b> 1110300016 A1200015 CA020T GRC610
	flat gasket PTFE ED ø 53mm ID ø 42.5mm thickness 3mm Qty 1 pcs equiv. no. 12001/02286 suitable for Astoria/Aurora/Brasilia/Wega		



 <p>1</p>			
<b>Part No.</b>	417002	<b>Ref. No.</b>	F351
<b>description</b>	heating element 1500W 230V heating circuits 2 mounting ø 42mm hole distance 74mm L 140mm W 25mm H 58mm L1 16mm L2 54mm L3 70mm H1 26mm H2 32mm hole ø 11mm tube ø 8mm connection M6x1 immersion heater 2 hole flange suitable for FAEMA		
<b>accessories for</b>	417002		
	<b>Part No.</b>	528002	<b>Ref. No.</b> —
	flat gasket PTFE ED ø 57mm ID ø 42mm thickness 3mm Qty 1 pcs equiv. no. 12001/W10470 suitable for		
	<b>Part No.</b>	528488	<b>Ref. No.</b> —
	flat gasket fibre ED ø 57mm ID ø 42mm thickness 3mm Qty 1 pcs		









 <p>1</p>			
<b>Part No.</b>	417057	<b>Ref. No.</b>	A080
<b>description</b>	heating element 1500W 230V heating circuits 2 thread 1¼" L 145mm W 23mm H 37mm tube ø 8mm connection M4 immersion heater flange with thread		
<b>accessories for</b>	417057		
	<b>Part No.</b>	510405	<b>Ref. No.</b> —
	flat gasket fibre ED ø 56mm ID ø 42mm thickness 2mm for thread 1¼" Qty 1 pcs		
	<b>Part No.</b>	528021	<b>Ref. No.</b> 1110300016 A1200015 CA020T GRC610
	flat gasket PTFE ED ø 53mm ID ø 42.5mm thickness 3mm Qty 1 pcs equiv. no. 12001/02286 suitable for Astoria/Aurora/Brasilia/Wega		

 <p>1</p>			
<b>Part No.</b>	417021	<b>Ref. No.</b>	G346
<b>description</b>	heating element 1500W 230V heating circuits 3 mounting ø 40mm hole distance 52mm L 145mm W 34mm H 30mm hole ø 6.5mm connection male faston 6.3mm immersion heater 8 hole flange		

1 electric components







			
1			
<b>Part No.</b>	417011	<b>Ref. No.</b>	C181
<b>description</b>	heating element 1800W 230V heating circuits 3 hole distance 59mm L 170mm W 34mm H 35mm hole ø 9.7mm thermostat sleeves ø 7mm length thermostat sleeves 170mm number of thermostat sleeves 1 thermostat sleeve eccentric, non clinging tube ø 8.5mm connection male faston 6.3mm immersion heater 3 hole flange suitable for CIMBALI		
<b>accessories for</b>	417011		
	<b>Part No.</b>	528002	<b>Ref. No.</b> —
	flat gasket PTFE ED ø 57mm ID ø 42mm thickness 3mm Qty 1 pcs equiv. no. 12001/W10470 suitable for		
	<b>Part No.</b>	528488	<b>Ref. No.</b> —
	flat gasket fibre ED ø 57mm ID ø 42mm thickness 3mm Qty 1 pcs		

			
1			
<b>Part No.</b>	415006	<b>Ref. No.</b>	BF042
<b>description</b>	heating element 1880W 230V heating circuits 1 thread 1¼" L 147mm W 35mm H 26mm connection M4 immersion heater flange with thread copper		
<b>spare parts for</b>	415006		
	<b>Part No.</b>	510405	<b>Ref. No.</b> —
	flat gasket fibre ED ø 56mm ID ø 42mm thickness 2mm for thread 1¼" Qty 1 pcs		
<b>accessories for</b>	415006		
	<b>Part No.</b>	520232	<b>Ref. No.</b> —
	nut thread 1¼" H 5mm nickel-plated brass WS 47 Qty 1 pcs		
	<b>Part No.</b>	521103	<b>Ref. No.</b> —
	nut thread M4 H 3mm WS 7 brass Qty 20 pcs		
	<b>Part No.</b>	521104	<b>Ref. No.</b> —
	washer ID ø 4.3mm ED ø 8mm thickness 0.5mm brass Qty 20 pcs for thread M4		
	<b>Part No.</b>	528021	<b>Ref. No.</b> 1110300016 A1200015 CA020T GRC610
	flat gasket PTFE ED ø 53mm ID ø 42.5mm thickness 3mm Qty 1 pcs equiv. no. 12001/02286 suitable for Astoria/Aurora/Brasilia/Wega		
	<b>Part No.</b>	560111	<b>Ref. No.</b> —
	plain washer ID ø 4.3mm ED ø 9mm thickness 0.8mm SS Qty 20 pcs DIN 125A for thread M4		
	<b>Part No.</b>	560131	<b>Ref. No.</b> —
	hexagonal nut thread M4 H 3.2mm WS 7 SS DIN/ISO DIN 934 / ISO 4032/8673 Qty 20 pcs		

			
1			
<b>Part No.</b>	417084	<b>Ref. No.</b>	A084
<b>description</b>	heating element 2000W 220V heating circuits 2 hole distance 55mm L 220mm W 35mm H 65mm L1 35mm L2 40mm L3 140mm H1 35mm H2 30mm hole ø 10mm connection M6 immersion heater 4 hole fixing		





			
1			
<b>Part No.</b>	417185	<b>Ref. No.</b>	SM488
<b>description</b>	heating element 2000W 230V heating circuits 1 mounting ø 40mm L 183mm W 28mm H 38mm hole distance 58mm hole ø 9mm length thermostat sleeves 145mm thermostat sleeves ø 5mm number of thermostat sleeves 1 thermostat sleeve lateral, not adjacent windings 3 tube ø 8mm connection 1/8" immersion heater 2 hole flange suitable for SAN MARCO		

			
1			
<b>Part No.</b>	417046	<b>Ref. No.</b>	CA064
<b>description</b>	heating element 2000W 230V heating circuits 1 thread 1¼" L 200mm W 32mm H 26mm tube ø 8.5mm thermostat sleeves ø 6.5mm length thermostat sleeves 152mm connection M4 immersion heater connection length 25mm flange with thread		
<b>accessories for</b>	417046		
	<b>Part No.</b>	510405	<b>Ref. No.</b> —
	flat gasket fibre ED ø 56mm ID ø 42mm thickness 2mm for thread 1¼" Qty 1 pcs		
	<b>Part No.</b>	528021	<b>Ref. No.</b> 1110300016 A1200015 CA020T GRC610
	flat gasket PTFE ED ø 53mm ID ø 42.5mm thickness 3mm Qty 1 pcs equiv. no. 12001/02286 suitable for Astoria/Aurora/Brasilia/Wega		





			
1			
<b>Part No.</b>	417349	<b>Ref. No.</b>	G185
<b>description</b>	heating element 2000W 230V heating circuits 3 mounting ø 40mm hole distance 43mm L 125mm W 33mm H 30mm immersion heater 4 hole flange		



			
1			
<b>Part No.</b>	417019	<b>Ref. No.</b>	G185
<b>description</b>	heating element 2000W 230V heating circuits 3 mounting ø 40mm hole distance 43mm L 139mm W 30mm H 30mm hole ø 10mm tube ø 8.5mm connection male faston 6.3mm immersion heater 4 hole flange		







			
<b>Part No.</b>	417004	<b>Ref. No.</b>	F382
<b>description</b>	heating element 2400W 230V heating circuits 2 mounting ø 42mm hole distance 74mm L 175mm W 27mm H 58mm L1 30mm L2 55mm L3 90mm H1 28mm H2 30mm hole ø 9.5mm tube ø 8.5mm connection M6 immersion heater 2 hole flange suitable for FAEMA		
<b>accessories for</b>	417004		
	<b>Part No.</b>	525652	<b>Ref. No.</b> —
	grub screw thread M10 L 10mm brass DIN 914 intake hexagonal WS 5 Qty 1 pcs		
	<b>Part No.</b>	528002	<b>Ref. No.</b> —
	flat gasket PTFE ED ø 57mm ID ø 42mm thickness 3mm Qty 1 pcs equiv. no. 12001/W10470 suitable for		
	<b>Part No.</b>	528488	<b>Ref. No.</b> —
	flat gasket fibre ED ø 57mm ID ø 42mm thickness 3mm Qty 1 pcs		



			
<b>Part No.</b>	417107	<b>Ref. No.</b>	AS021
<b>description</b>	heating element 2600W 230V heating circuits 2 mounting ø 42mm hole distance 74mm L 295mm W 36mm H 41mm L1 22mm L2 38mm L3 235mm H1 30mm H2 11mm hole ø 10mm tube ø 8.5mm thermostat sleeves ø 6mm length thermostat sleeves 186mm thermostat sleeve not clinging number of thermostat sleeves 1 connection M6x1 immersion heater 2 hole flange		

			
<b>Part No.</b>	417025	<b>Ref. No.</b>	SM246
<b>description</b>	heating element 2600W 230V heating circuits 3 mounting ø 46mm hole distance 62mm L 380mm W 35mm H 58mm L1 30mm L2 60mm L3 290mm H1 32mm H2 28mm hole ø 11mm tube ø 8.5mm thermostat sleeves ø 7mm length thermostat sleeves 208mm thermostat sleeve not clinging number of thermostat sleeves 1 connection M3 immersion heater 3 hole flange suitable for SAN MARCO		
<b>accessories for</b>	417025		
	<b>Part No.</b>	527169	<b>Ref. No.</b> —
	hexagonal nut thread M3 H 2.8mm WS 5.5 brass Qty 1 pcs		
	<b>Part No.</b>	560110	<b>Ref. No.</b> —
	plain washer ID ø 3.2mm ED ø 7mm thickness 0.5mm SS Qty 20 pcs DIN 125A for thread M3		
	<b>Part No.</b>	560130	<b>Ref. No.</b> —
	hexagonal nut thread M3 H 2.4mm WS 5.5 SS DIN/ISO DIN 934 / ISO 4032/8673 Qty 20 pcs		

			
<b>Part No.</b>	417015	<b>Ref. No.</b>	C182
<b>description</b>	heating element 2700W 230V heating circuits 1 mounting ø 54mm hole distance 55mm L 232mm W 35mm H 43mm hole ø 9mm thermostat sleeves ø 7mm length thermostat sleeves 230/240mm number of thermostat sleeves 2 thermostat sleeve not clinging tube ø 8.5mm connection M6x1 immersion heater 4 hole flange suitable for CIMBALI		
<b>accessories for</b>	417015		
	<b>Part No.</b>	529496	<b>Ref. No.</b> —
	gasket fibre D1 ø 54mm D2 ø 98mm thickness 3mm hole ø 6.7mm hole distance 55mm for heating element suitable for CIMBALI M15		



			
<b>Part No.</b>	417354	<b>Ref. No.</b>	A2100146
<b>description</b>	heating element 2700W 230V heating circuits 3 mounting ø 42mm hole distance 74mm L 160mm W 34mm H 45mm L1 20mm L2 70mm L3 80mm H1 32mm H2 13mm hole ø 10mm tube ø 8.3mm thermostat sleeves ø 7mm length thermostat sleeves 140mm thermostat sleeve centre number of thermostat sleeves 1 connection male faston 6.3mm immersion heater 2 hole flange		

			
<b>Part No.</b>	417355	<b>Ref. No.</b>	A2100213
<b>description</b>	heating element 2700W 230V heating circuits 3 thread 1¼" L 160mm W 30mm H 45mm tube ø 8mm connection male faston 6.3mm immersion heater flange with thread WS 37		
<b>accessories for</b>	417355		
	<b>Part No.</b>	528017	<b>Ref. No.</b> —
	flat gasket fibre ED ø 53mm ID ø 42mm thickness 2mm for thread 1¼" Qty 1 pcs		
	<b>Part No.</b>	528022	<b>Ref. No.</b> —
	flat gasket PTFE ED ø 52mm ID ø 41mm thickness 2mm size 1¼" Qty 1 pcs suitable for CARIMALI, FAEMA, MARZOCCO, PAVONI		

			
<b>Part No.</b>	417062	<b>Ref. No.</b>	P073
<b>description</b>	heating element 3000W 230/400V heating circuits 3 thread 1¼" L 238mm W 32mm H 26mm tube ø 8mm connection male faston 6.3mm immersion heater flange with thread		
<b>accessories for</b>	417062		
	<b>Part No.</b>	510405	<b>Ref. No.</b> —
	flat gasket fibre ED ø 56mm ID ø 42mm thickness 2mm for thread 1¼" Qty 1 pcs		
	<b>Part No.</b>	528021	<b>Ref. No.</b> 1110300016 A1200015 CA020T GRC610
	flat gasket PTFE ED ø 53mm ID ø 42.5mm thickness 3mm Qty 1 pcs equiv. no. 12001/02286 suitable for Astoria/Aurora/Brasilia/Wega		





			
<b>Part No.</b>	417029	<b>Ref. No.</b>	SM489
<b>description</b>	heating element 3000W 230V heating circuits 2 mounting ø 40mm L 325mm W 33mm H 28mm hole distance 58mm hole ø 9mm length thermostat sleeves 125mm thermostat sleeves ø 5mm number of thermostat sleeves 1 thermostat sleeve centre not clinging windings 2 tube ø 8mm connection M3 immersion heater 2 hole flange suitable for SAN MARCO		
<b>accessories for</b>	417029		
	<b>Part No.</b>	527169	<b>Ref. No.</b> —
	hexagonal nut thread M3 H 2.8mm WS 5.5 brass Qty 1 pcs		
	<b>Part No.</b>	560110	<b>Ref. No.</b> —
	plain washer ID ø 3.2mm ED ø 7mm thickness 0.5mm SS Qty 20 pcs DIN 125A for thread M3		
	<b>Part No.</b>	560130	<b>Ref. No.</b> —
	hexagonal nut thread M3 H 2.4mm WS 5.5 SS DIN/ISO DIN 934 / ISO 4032/8673 Qty 20 pcs		



			
<b>Part No.</b>	417356	<b>Ref. No.</b>	1240100121 GR705
<b>description</b>	heating element 3200W 230V heating circuits 2 mounting ø 42.5mm hole distance 75mm L 340mm W 33mm H 45mm L1 30mm L2 67mm L3 243mm H1 26mm H2 19mm hole ø 9.5mm tube ø 8.2mm connection M6 immersion heater 2 hole flange		
<b>For models:</b>	Zola-1, Zola-2		
<b>accessories for</b>	417356		
	<b>Part No.</b>	526825	<b>Ref. No.</b> 1110300019 F043T GR709
	flat gasket PTFE ED ø 58mm ID ø 43mm thickness 3mm Qty 1 pcs		



			
<b>Part No.</b>	417358	<b>Ref. No.</b>	1240100127 GRC102
<b>description</b>	heating element 3300W 230V heating circuits 2 thread 1¼" L 230mm W 38mm H 38mm tube ø 8mm connection male faston 6.3mm immersion heater connection length 55mm flange with thread coffee machine WS 37		
<b>For models:</b>	Eclisse, Ten, Twenty		

			
<b>Part No.</b>	417353	<b>Ref. No.</b>	A2100031
<b>description</b>	heating element 3500W 230/400V heating circuits 3 mounting ø 43mm hole distance 74mm L 295mm W 34mm H 45mm L1 35mm L2 55mm L3 205mm H1 31mm H2 14mm hole ø 9.5mm tube ø 8.3mm thermostat sleeves ø 7mm length thermostat sleeves 210mm thermostat sleeve centre number of thermostat sleeves 1 connection male faston 6.3mm immersion heater 2 hole flange		
<b>accessories for</b>	417353		
	<b>Part No.</b>	528021	<b>Ref. No.</b> 1110300016 A1200015 CA020T GRC610
	flat gasket PTFE ED ø 53mm ID ø 42.5mm thickness 3mm Qty 1 pcs equiv. no. 12001/02286 suitable for Astoria/Aurora/Brasilia/Wega		

			
<b>Part No.</b>	417352	<b>Ref. No.</b>	A2100120
<b>description</b>	heating element 4000W 230/400V heating circuits 3 mounting ø 43mm hole distance 74mm L 545mm W 34mm H 45mm L1 35mm L2 55mm L3 455mm H1 31mm H2 14mm hole ø 9.5mm tube ø 8.3mm thermostat sleeves ø 7mm length thermostat sleeves 210mm thermostat sleeve centre number of thermostat sleeves 1 connection male faston 6.3mm immersion heater 2 hole flange		

			
<b>Part No.</b>	417091	<b>Ref. No.</b>	GRIMAC
<b>description</b>	heating element 4000W 230V heating circuits 2 hole distance 53mm L 455mm W 39mm H 58mm L1 30mm L2 50mm L3 380mm H1 26mm H2 32mm hole ø 9mm tube ø 8mm connection M6 immersion heater 4 hole flange		



			
<b>Part No.</b>	417446	<b>Ref. No.</b>	BF050
<b>description</b>	heating element 4000W 230V heating circuits 2 mounting ø 38.5mm hole distance 57mm L 342mm W 26mm H 51mm L1 35mm L2 50mm L3 257mm H1 25mm H2 26mm windings 2 hole ø 10mm tube ø 8mm connection M6 immersion heater 3 hole flange		
<b>accessories for</b>	417446		
	<b>Part No.</b>	528740	<b>Ref. No.</b> —
	gasket ID ø 44mm PTFE thickness 3.5mm hole ø 9.5mm hole distance 58mm suitable for ITALCREM, VISACREM for heating element coffee machine parts		

			
<b>Part No.</b>	417202	<b>Ref. No.</b>	V583/2
<b>description</b>	heating element 4000W 230V heating circuits 3 mounting ø 42mm hole distance 74mm L 295mm W 34mm H 63mm L1 30mm L2 70mm L3 190mm H1 31mm H2 32mm hole ø 9mm tube ø 8.5mm thermostat sleeves ø 6.5mm length thermostat sleeves 199mm thermostat sleeve not clinging number of thermostat sleeves 1 connection male faston 6.3mm immersion heater 2 hole flange		
<b>accessories for</b>	417202		
	<b>Part No.</b>	528022	<b>Ref. No.</b> —
	flat gasket PTFE ED ø 52mm ID ø 41mm thickness 2mm size 1¼" Qty 1 pcs suitable for CARIMALI, FAEMA, MARZOCCO, PAVONI		
	<b>Part No.</b>	528488	<b>Ref. No.</b> —
	flat gasket fibre ED ø 57mm ID ø 42mm thickness 3mm Qty 1 pcs		

			
<b>Part No.</b>	417357	<b>Ref. No.</b>	1240100124 GR706
<b>description</b>	heating element 4500W 230V heating circuits 2 mounting ø 42.5mm hole distance 75mm L 480mm W 33mm H 50mm L1 23mm L2 52mm L3 405mm H1 26mm H2 24mm hole ø 9.5mm tube ø 8mm connection M6 immersion heater 2 hole flange		
<b>For models:</b>	Zola-1, Zola-2		









			
<b>Part No.</b>	417359	<b>Ref. No.</b>	1240100129 GRT103
<b>description</b>	heating element 4500W 230V heating circuits 2 thread 1¼" L 345mm W 35mm H 35mm tube ø 8.2mm connection male faston 6.3mm immersion heater connection length 53mm flange with thread immersion heater WS 37		
<b>For models:</b>	Eclipse, Ten, Twenty		
<b>spare parts for</b>	417359		
	<b>Part No.</b>	510405	<b>Ref. No.</b> —
	flat gasket fibre ED ø 56mm ID ø 42mm thickness 2mm for thread 1¼" Qty 1 pcs		
	<b>Part No.</b>	528021	<b>Ref. No.</b> 1110300016 A1200015 CA020T GRC610
	flat gasket PTFE ED ø 53mm ID ø 42.5mm thickness 3mm Qty 1 pcs equiv. no. 12001/02286 suitable for Astoria/Aurora/Brasilia/Wega		

			
<b>Part No.</b>	417112	<b>Ref. No.</b>	V583/3
<b>description</b>	heating element 4500W 230V heating circuits 3 mounting ø 42mm hole distance 74mm L 390mm W 35mm H 70mm L1 30mm L2 50mm L3 300mm H1 33mm H2 37mm hole ø 9mm tube ø 8mm thermostat sleeves ø 6.5mm length thermostat sleeves 200mm thermostat sleeve not clinging number of thermostat sleeves 1 connection male faston 6.3mm immersion heater 2 hole flange		

			
<b>Part No.</b>	417141	<b>Ref. No.</b>	SM251
<b>description</b>	heating element 4500W 230V heating circuits 3 mounting ø 46mm hole distance 60mm L 553mm W 34mm H 62mm L1 30mm L2 70mm L3 453mm H1 31mm H2 31mm hole ø 11mm tube ø 8mm thermostat sleeves ø 7mm length thermostat sleeves 200mm thermostat sleeve centre not clinging connection M3 immersion heater 3 hole flange suitable for SAN MARCO		
<b>accessories for</b>	417141		
	<b>Part No.</b>	527169	<b>Ref. No.</b> —
	hexagonal nut thread M3 H 2.8mm WS 5.5 brass Qty 1 pcs		
	<b>Part No.</b>	560110	<b>Ref. No.</b> —
	plain washer ID ø 3.2mm ED ø 7mm thickness 0.5mm SS Qty 20 pcs DIN 125A for thread M3		
	<b>Part No.</b>	560130	<b>Ref. No.</b> —
	hexagonal nut thread M3 H 2.4mm WS 5.5 SS DIN/ISO DIN 934 / ISO 4032/8673 Qty 20 pcs		

			
<b>Part No.</b>	417063	<b>Ref. No.</b>	CA058
<b>description</b>	heating element 4500W 230V heating circuits 3 thread 1¼" L 290mm W 30mm H 27mm tube ø 8mm connection male faston 6.3mm immersion heater connection length 35mm flange with thread coffee machine WS 38		
<b>accessories for</b>	417063		
	<b>Part No.</b>	510405	<b>Ref. No.</b> —
	flat gasket fibre ED ø 56mm ID ø 42mm thickness 2mm for thread 1¼" Qty 1 pcs		

<b>accessories for</b>	417063		
	<b>Part No.</b>	528021	<b>Ref. No.</b> 1110300016 A1200015 CA020T GRC610
	flat gasket PTFE ED ø 53mm ID ø 42.5mm thickness 3mm Qty 1 pcs equiv. no. 12001/02286 suitable for Astoria/Aurora/Brasilia/Wega		

			
<b>Part No.</b>	417119	<b>Ref. No.</b>	G187
<b>description</b>	heating element 5000W 220V heating circuits 2 mounting ø 40mm hole distance 43mm L 398mm W 32mm H 33mm hole ø 9mm connection male faston 6.3mm immersion heater 4 hole flange		

## radiation heaters

			
<b>Part No.</b>	416656	<b>Ref. No.</b>	8184544 X064
<b>description</b>	radiation heater rectangular 4000W 230V L 490mm W 245mm heating circuits 2 connections 2+2 IRCA		
<b>spare parts for</b>	416656		
	<b>Part No.</b>	417727	<b>Ref. No.</b> —
	terminal L 20m W 8.2mm		

## accessories

### sealing washers

### PTFE gaskets

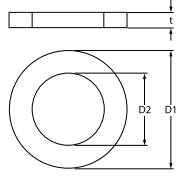
 			
<b>Part No.</b>	528021	<b>Ref. No.</b>	1110300016 A1200015 CA020T GRC610
<b>description</b>	flat gasket PTFE ED ø 53mm ID ø 42.5mm thickness 3mm Qty 1 pcs equiv. no. 12001/02286 suitable for Astoria/Aurora/Brasilia/Wega		
<b>For models:</b>	Eclipse, Ten, Twenty		

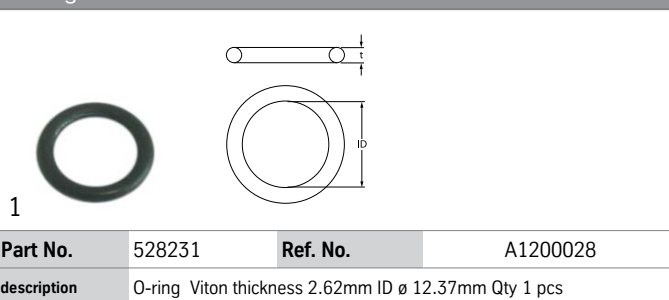

## O-rings

			
1			
<b>Part No.</b>	528231	<b>Ref. No.</b>	A1200028
<b>description</b>	O-ring Viton thickness 2.62mm ID ø 12.37mm Qty 1 pcs		

## thermostats

## bi-metal thermostats

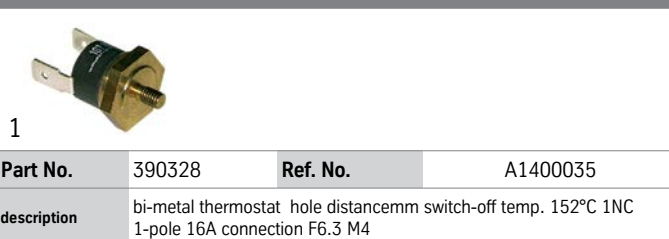

## bi-metal thermostats

			
1			
<b>Part No.</b>	390328	<b>Ref. No.</b>	A1400035
<b>description</b>	bi-metal thermostat hole distance mm switch-off temp. 152°C 1NC 1-pole 16A connection F6.3 M4		

## switches and momentary switches

## rocker/momentary rocker switches

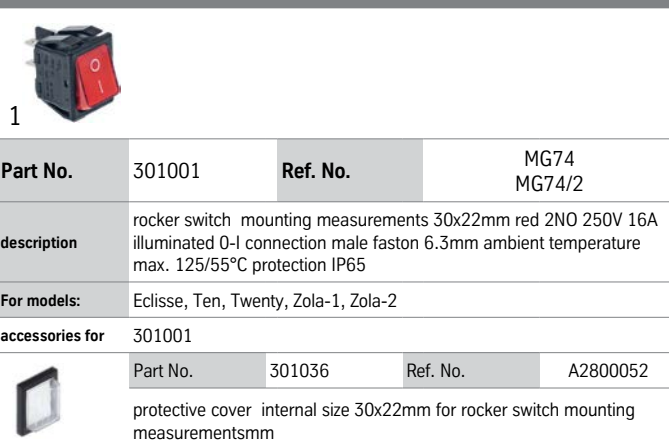

## 30x22mm

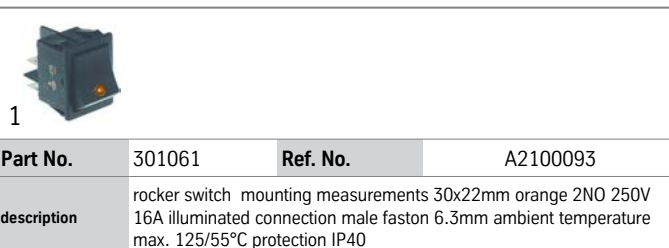
			
1			
<b>Part No.</b>	301001	<b>Ref. No.</b>	MG74 MG74/2
<b>description</b>	rocker switch mounting measurements 30x22mm red 2NO 250V 16A illuminated 0-I connection male faston 6.3mm ambient temperature max. 125/55°C protection IP65		
<b>For models:</b>	Eclisse, Ten, Twenty, Zola-1, Zola-2		
<b>accessories for</b>	301001		
		<b>Part No.</b>	301036
		<b>Ref. No.</b>	A2800052
	protective cover internal size 30x22mm for rocker switch mounting measurementsmm		

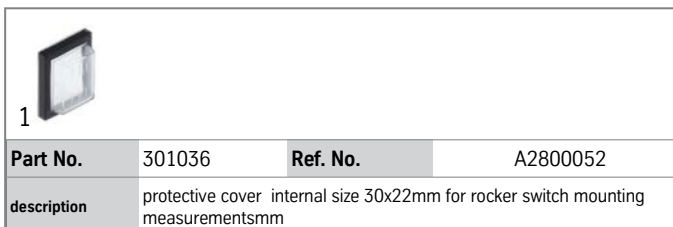

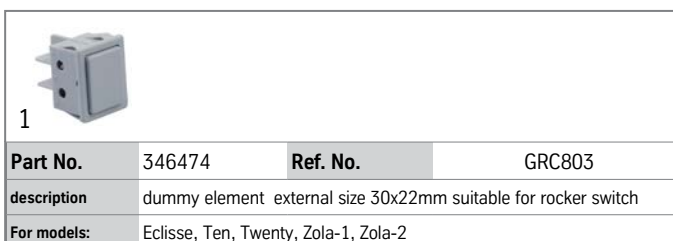
			
1			
<b>Part No.</b>	301061	<b>Ref. No.</b>	A2100093
<b>description</b>	rocker switch mounting measurements 30x22mm orange 2NO 250V 16A illuminated connection male faston 6.3mm ambient temperature max. 125/55°C protection IP40		

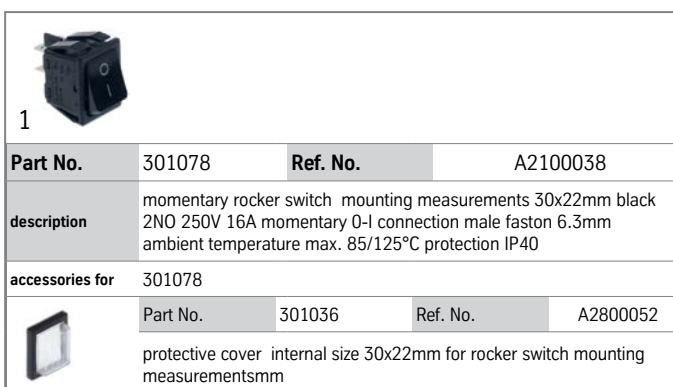
			
1			
<b>Part No.</b>	301036	<b>Ref. No.</b>	A2800052
<b>description</b>	protective cover internal size 30x22mm for rocker switch mounting measurementsmm		

			
1			
<b>Part No.</b>	346474	<b>Ref. No.</b>	GRC803
<b>description</b>	dummy element external size 30x22mm suitable for rocker switch		
<b>For models:</b>	Eclisse, Ten, Twenty, Zola-1, Zola-2		

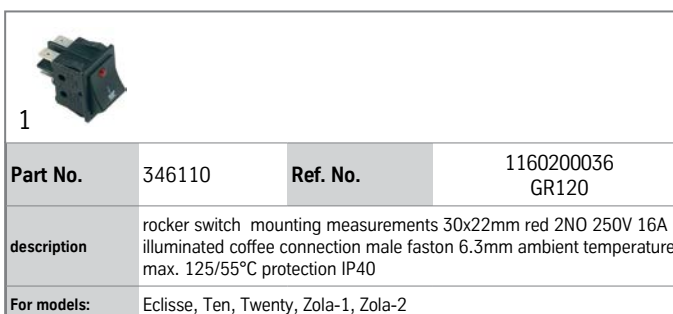
			
1			
<b>Part No.</b>	301078	<b>Ref. No.</b>	A2100038
<b>description</b>	momentary rocker switch mounting measurements 30x22mm black 2NO 250V 16A momentary 0-I connection male faston 6.3mm ambient temperature max. 85/125°C protection IP40		
<b>accessories for</b>	301078		
		<b>Part No.</b>	301036
		<b>Ref. No.</b>	A2800052
	protective cover internal size 30x22mm for rocker switch mounting measurementsmm		

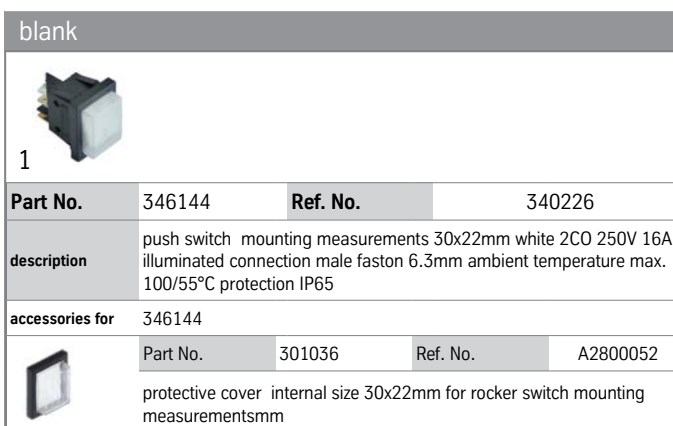
			
1			
<b>Part No.</b>	346110	<b>Ref. No.</b>	1160200036 GR120
<b>description</b>	rocker switch mounting measurements 30x22mm red 2NO 250V 16A illuminated coffee connection male faston 6.3mm ambient temperature max. 125/55°C protection IP40		
<b>For models:</b>	Eclisse, Ten, Twenty, Zola-1, Zola-2		

<b>blank</b>			
			
1			
<b>Part No.</b>	346144	<b>Ref. No.</b>	340226
<b>description</b>	push switch mounting measurements 30x22mm white 2CO 250V 16A illuminated connection male faston 6.3mm ambient temperature max. 100/55°C protection IP65		
<b>accessories for</b>	346144		
		<b>Part No.</b>	301036
		<b>Ref. No.</b>	A2800052
	protective cover internal size 30x22mm for rocker switch mounting measurementsmm		





push/momentary push switches

19x13mm			
			
1			
<b>Part No.</b>	347292 <sup>1</sup>	<b>Ref. No.</b>	A2100043
<b>description</b>	push switch mounting measurements 19x13mm red 2NO 250V 16A illuminated connection male faston 6.3mm ambient temperature max. 105/55°C protection IP65 with cover cap		

<sup>1</sup>illuminated

30x22mm			
			
1			
<b>Part No.</b>	301036	<b>Ref. No.</b>	A2800052
<b>description</b>	protective cover internal size 30x22mm for rocker switch mounting measurementsmm		

ø25mm			
			
1			
<b>Part No.</b>	347295	<b>Ref. No.</b>	A2100041
<b>description</b>	push button mounting ø 25mm black 2NO 250V 16A connection male faston 6.3mm ambient temperature max. 85°C protection IP40		

			
1			
<b>Part No.</b>	347294 <sup>1</sup>	<b>Ref. No.</b>	A2100045
<b>description</b>	push switch mounting ø 25mm red 2NO 250V 16A illuminated connection male faston 6.3mm ambient temperature max. 125/55°C protection IP40		

<sup>1</sup>illuminated

			
1			
<b>Part No.</b>	347293	<b>Ref. No.</b>	A2100094
<b>description</b>	push switch mounting ø 25mm orange 2NO 250V 16A illuminated cup connection male faston 6.3mm ambient temperature max. 85°C protection IP40		

accessories

push buttons			
			
1			
<b>Part No.</b>	347300	<b>Ref. No.</b>	1160200056 MG543
<b>description</b>	push button external size 17x13mm shaft 3.5x3.5mm chrome oval		
<b>For models:</b>	Eclisse, Ten, Twenty, Zola-1, Zola-2		

microswitches

pin-plunger actuated			
			
1			
<b>Part No.</b>	346145	<b>Ref. No.</b>	210031
<b>description</b>	microswitch with plunger 250V 10A 1CO connection male faston 4.8mm ambient temperature max. 125°C mounting distance 22mm black		

			
1			
<b>Part No.</b>	347757	<b>Ref. No.</b>	A2100297
<b>description</b>	microswitch with plunger 250V 16A 1CO connection male faston 4.8mm ambient temperature max. 125°C mounting distance 22mm actuating force: 120g black		

roller actuated

roller 0°			
			
1			
<b>Part No.</b>	346370	<b>Ref. No.</b>	1160300035 GR779 W612
<b>description</b>	microswitch with roller plunger 230V 16A 1CO connection screw L1 49mm ambient temperature max. 125°C thread L 14mm thread M10 mounting distance 25mm actuating force: 300g type MV15-2		
<b>For models:</b>	Eclisse, Ten, Twenty, Zola-1, Zola-2		

roller 90°

			
1			
<b>Part No.</b>	345104	<b>Ref. No.</b>	A2100042
<b>description</b>	microswitch with roller plunger 250V 16A 1CO connection male faston 6.3mm L 24mm ambient temperature max. 125°C thread L 12mm thread M10x0.75 mounting distance 22mm actuating force: 280g type EF83161.1		





## system switches (ROLD)



1

<b>Part No.</b>	345720	<b>Ref. No.</b>	1160200057 MG544
<b>description</b>	switch 2NO 250V 16A connection male faston 6.3mm		
<b>For models:</b>	Eclisse, Ten, Twenty, Zola-1, Zola-2		

## rotary switches

## BREMAS

## accessories



1

<b>Part No.</b>	527259	<b>Ref. No.</b>	1210100086 GR272
<b>description</b>	knob push-in ø 34/60mm shaft ø 5x5mm black H 21.4mm L 49mm		
<b>For models:</b>	Eclisse, Ten, Twenty, Zola-1, Zola-2		

## TECNOMATIC



1

<b>Part No.</b>	347297	<b>Ref. No.</b>	1160100006 GR273 GRC107
<b>description</b>	rotary switch 3 1-0-2 sets of contacts 6 type HD1607R012 600V 16A shaft ø 5x5mm shaft L 23mm shaft square with knob connection screw clamp		
<b>For models:</b>	Eclisse, Ten, Twenty, Zola-1, Zola-2		
<b>accessories for</b>	347297		
	<b>Part No.</b>	111012	<b>Ref. No.</b> —
	knob switch zero mark t.max.°C ø 34/60mm shaft ø 5x5mm shaft flat black H 22mm L 50mm		

## miscellaneous



1

<b>Part No.</b>	347296	<b>Ref. No.</b>	A2100316
<b>description</b>	rotary switch 25A shaft L 15mm with cable 6-pole shaft 5x5mm		

## accessories

## symbol labels



1

<b>Part No.</b>	347342	<b>Ref. No.</b>	1080400014 GR265
<b>description</b>	symbol label CE 0-1-2 L 67mm W 50.5mm bore ø 9mm		
<b>For models:</b>	Eclisse, Ten, Twenty, Zola-1, Zola-2		

## control equipment

## MOELLER/EATON

## LED signal elements



1

<b>Part No.</b>	346487	<b>Ref. No.</b>	A2100319
<b>description</b>	indicator lamp white connection screw LED 85-264VAC		

## lamps

## indicator lights

## indicator lights (complete)

## ø 6mm



1

<b>Part No.</b>	359568	<b>Ref. No.</b>	A2100024
<b>description</b>	indicator light ø 6mm 230V red connection male faston 2.8mm cable length 250mm		

## ø 10mm

## with plug-in socket



1

<b>Part No.</b>	359140	<b>Ref. No.</b>	A2100046
<b>description</b>	indicator light ø 10mm yellow 230V connection male faston 6.3mm Qty 1 pcs		

## miscellaneous



1

<b>Part No.</b>	359006	<b>Ref. No.</b>	359.006
<b>description</b>	indicator light white 230V		



## contactors

## ISKRA (FANAL)

## power contactors



1

<b>Part No.</b>	380413	<b>Ref. No.</b>	21003F
<b>description</b>	power contactor resistive load 20A 400VAC (AC3/400V) 8.5A/5.5kW main contacts 3NO auxiliary contacts 1NC connection screw connection type Fanal DSL7 01 type ISKRA K07M 01		

## SIEMENS

## power contactors



1

<b>Part No.</b>	380526	<b>Ref. No.</b>	A2100154
<b>description</b>	power contactor resistive load 20A 230VAC (AC3/400V) 8.4A/4kW main contacts 4NO auxiliary contacts connection screw connection type 3TG10-10-0A2L2		

## relays

## power relays

## with bracket mounting



1

<b>Part No.</b>	380920	<b>Ref. No.</b>	A3200109
<b>description</b>	power relays FINDER 400VAC 10A 3CO connection male faston 4.8mm with mounting strap manuf. no. 60.63.8.400.0000 250V 3-pole		

## level relays

## GICAR



1

<b>Part No.</b>	400524	<b>Ref. No.</b>	A1500005
<b>description</b>	level relay 230V voltage AC connection F6.3 type RL30 MICRO ST SAFETY PUMP		

## DTI



1

<b>Part No.</b>	402445	<b>Ref. No.</b>	A1500082
<b>description</b>	level controller 230V voltage AC 50/60Hz 8A connection F6.3 type DCLDD11000		

## miscellaneous



1

<b>Part No.</b>	402463	<b>Ref. No.</b>	104010006 F485 GR778 RLC302CF
<b>description</b>	level controller 230-240V 50-60Hz		
<b>For models:</b>	Eclisse, Ten, Twenty, Zola-1, Zola-2		



## electronics

## PCBs



1

<b>Part No.</b>	402447	<b>Ref. No.</b>	A1500096
<b>description</b>	keypad PCB L 125mm W 35mm with front panel buttons 6		



1

<b>Part No.</b>	402497	<b>Ref. No.</b>	A1500098
<b>description</b>	keypad PCB L 83mm W 48mm with display buttons 4		



1

<b>Part No.</b>	402495	<b>Ref. No.</b>	A1500097
<b>description</b>	PCB L 74mm W 64mm 230V		

## central units



1

<b>Part No.</b>	402462	<b>Ref. No.</b>	104020009 GRT104
<b>description</b>	central unit 230V 50/60Hz type DOS 3GR+RL/F-C voltage AC		
<b>For models:</b>	Eclisse, Ten, Twenty, Zola-1, Zola-2		



1

<b>Part No.</b>	402460	<b>Ref. No.</b>	1040200015 GRW157
<b>description</b>	central unit 230V 50/60Hz type DOS7 RL3 4GR+RL+THE voltage AC		
<b>For models:</b>	Eclisse, Ten, Twenty, Zola-1, Zola-2		



1

<b>Part No.</b>	402461	<b>Ref. No.</b>	1040200008 GRC103
<b>description</b>	central unit 240V 50/60Hz type DOS 2GR+RL/F-C voltage AC		
<b>For models:</b>	Eclisse, Ten, Twenty, Zola-1, Zola-2		



1

<b>Part No.</b>	402470	<b>Ref. No.</b>	1040200012 GRW1130
<b>description</b>	central unit 240V 50/60Hz type DOS RLO 1GR+RL+SIC/F voltage AC		
<b>For models:</b>	Eclisse, Ten, Twenty, Zola-1, Zola-2		



1

<b>Part No.</b>	402459	<b>Ref. No.</b>	1040200013 GRW156
<b>description</b>	central unit 240V 50/60Hz type DOS7 RL3 2GR+RL+THE voltage AC		
<b>For models:</b>	Eclisse, Ten, Twenty, Zola-1, Zola-2		



1	<b>Part No.</b>	402456	<b>Ref. No.</b>	A1500095
	<b>description</b>	central unit 3-group 230V 50/60Hz type SDE3D FI3NBV6		



1	<b>Part No.</b>	402454	<b>Ref. No.</b>	A1500070
	<b>description</b>	central unit 3-group 230V type SDE3D FI3NAV6		



1	<b>Part No.</b>	402171	<b>Ref. No.</b>	1040100002 MG307/1
	<b>description</b>	control box for coffee machine 230V type MFC2SG		
	<b>For models:</b>	Eclisse, Ten, Twenty, Zola-1, Zola-2		

dosing electronics

miscellaneous



1	<b>Part No.</b>	402455	<b>Ref. No.</b>	A1500073
	<b>description</b>	dosing electronics 230V 50/60Hz type SDE11		

keypads

front foils

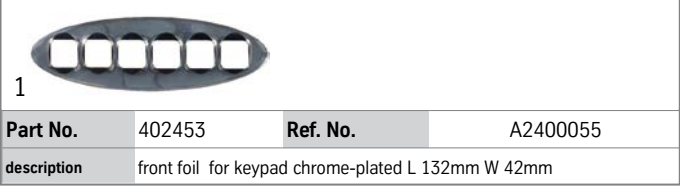

1	<b>Part No.</b>	402453	<b>Ref. No.</b>	A2400055
	<b>description</b>	front foil for keypad chrome-plated L 132mm W 42mm		

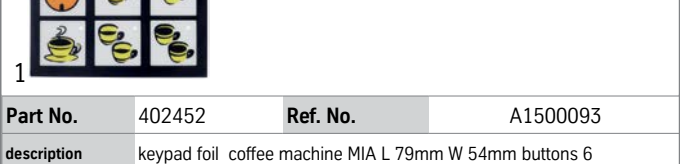

1	<b>Part No.</b>	402452	<b>Ref. No.</b>	A1500093
	<b>description</b>	keypad foil coffee machine MIA L 79mm W 54mm buttons 6		

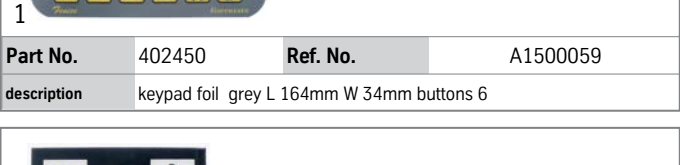

1	<b>Part No.</b>	402450	<b>Ref. No.</b>	A1500059
	<b>description</b>	keypad foil grey L 164mm W 34mm buttons 6		

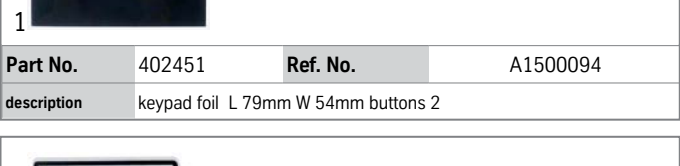

1	<b>Part No.</b>	402451	<b>Ref. No.</b>	A1500094
	<b>description</b>	keypad foil L 79mm W 54mm buttons 2		

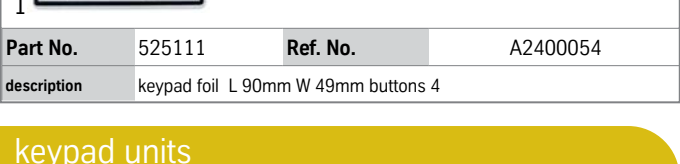

1	<b>Part No.</b>	525111	<b>Ref. No.</b>	A2400054
	<b>description</b>	keypad foil L 90mm W 49mm buttons 4		

keypad units





1	<b>Part No.</b>	402448	<b>Ref. No.</b>	A1500092
	<b>description</b>	keypad unit buttons 2 L 88mm W 60mm		



			
1			
<b>Part No.</b>	402562	<b>Ref. No.</b>	2040300001 GRW159
<b>description</b>	keypad unit buttons 5 black/silver with switch lighting LED L 155mm W 47mm switch		
<b>For models:</b>	Eclisse, Ten, Twenty, Zola-1, Zola-2		

			
2			
<b>Part No.</b>	402446	<b>Ref. No.</b>	A1500034
<b>description</b>	keypad unit buttons 6 grey L 164mm W 34mm		

			
1			
<b>Part No.</b>	402561	<b>Ref. No.</b>	1040300026 GRC104
<b>description</b>	keypad unit coffee machine EDISSE/TEN/TWENTY/ZOLA 1+2 buttons 5 black/white lighting LED L 115mm W 45mm		
<b>For models:</b>	Eclisse, Ten, Twenty, Zola-1, Zola-2		

			
1			
<b>Part No.</b>	402585	<b>Ref. No.</b>	1040200004 GR159
<b>description</b>	keypad unit coffee machine EDISSE/TEN/TWENTY/ZOLA 1+2 buttons 5 yellow/grey type TH SMT 1GR+RL lighting LED		
<b>For models:</b>	Eclisse, Ten, Twenty, Zola-1, Zola-2		

			
1			
<b>Part No.</b>	402449	<b>Ref. No.</b>	A1500091
<b>description</b>	keypad unit coffee machine FIORENZATO buttons 6 L 88mm W 60mm		

## solenoid valves



## solenoid valves (water)

metal

ODE

solenoid valves steam (water)

21A series

			
1			
<b>Part No.</b>	370573	<b>Ref. No.</b>	A1900002
<b>description</b>	solenoid valve brass 2-ways 230VAC inlet 1/8" outlet 1/8" connection 1/8" L 40mm DN 2.5mm -10 up to 140°C type series 21A coil type ADA membranes FKM (water/steam) p max 14bar 50Hz		
<b>accessories for</b>	370573		
	<b>Part No.</b>	371091	<b>Ref. No.</b> —
	power socket plug type DIN 43650B cable lengthmm small		

31A1 series

			
1			
<b>Part No.</b>	370572	<b>Ref. No.</b>	A1900003
<b>description</b>	solenoid valve brass 3-ways 230VAC DN 1.5mm -10 up to 140°C coil type ADA membranes ruby p max 15bar p min 0bar flange 32x32mm		

4827K series

			
1			
<b>Part No.</b>	370571	<b>Ref. No.</b>	A1900068
<b>description</b>	solenoid valve brass 2-ways 230VAC DN 2mm -10 up to 140°C coil type ADA membranes FKM (water/steam) p max 22bar p min 0bar 50Hz flange 32x32mm		



solenoid valves (various)



1			
<b>Part No.</b>	370119	<b>Ref. No.</b>	A1900029
<b>description</b>	solenoid valve 2-ways 230VAC flange 25x25mm		

pressure switches  
for coffee machines

ø 38mm



1			
<b>Part No.</b>	541725	<b>Ref. No.</b>	A2100051
<b>description</b>	pressure control ø 38mm pressure range 0.5-1.2bar 21A 250V connection 1/4" 1CO pressure connection 1/4"		



1			
<b>Part No.</b>	541726	<b>Ref. No.</b>	A2100305
<b>description</b>	pressure control ø 38mm pressure range 0.5-1.5bar 16A 250V connection 1/4" pressure connection 1/4"		

electrodes



1			
<b>Part No.</b>	400214	<b>Ref. No.</b>	GRC605
<b>description</b>	level electrode 1/4" total length 140mm probe L 112mm insulated probe length 26mm connection male faston 6.3mm stainless steel ø 2.5mm		
<b>For models:</b>	Eclisse, Ten, Twenty		



1			
<b>Part No.</b>	402457	<b>Ref. No.</b>	A1400001
<b>description</b>	level electrode 1/4" total length 145mm probe L 124mm insulated probe length 20mm connection curved ø 2.5mm		



1			
<b>Part No.</b>	401242	<b>Ref. No.</b>	2250400001 GR212
<b>description</b>	level electrode 1/4" total length 155mm probe L 128mm insulated probe length 26mm connection male faston 6.3mm stainless steel ø 2.5mm		
<b>For models:</b>	Zola-1, Zola-2		



1			
<b>Part No.</b>	402458	<b>Ref. No.</b>	A1400003
<b>description</b>	level electrode 1/4" total length 75mm probe L 54mm insulated probe length 20mm connection curved ø 2.5mm		

motors

motors

for coffee grinders

components



1			
<b>Part No.</b>	500239	<b>Ref. No.</b>	190067 270012
<b>description</b>	motor 230V 50Hz 1 phase ø 100mm ID ø 65mm H 195mm shaft ø 16mm type T48		



1			
<b>Part No.</b>	500238	<b>Ref. No.</b>	190050 270003
<b>description</b>	motor 230V 50Hz 1 phase ø 110mm ID ø 65mm H 160mm shaft ø 14mm type T80		





1 electric components



## pumps

### booster pumps II

#### pump heads

#### FLUID-O-TECH



1			
<b>Part No.</b>	500065	<b>Ref. No.</b>	1220200004 V510
<b>description</b>	pump head PA204F FLUID-O-TECH L 82mm 200l/h connection 3/8" NPT with bypass brass 3 hole flange for coffee machine shaft ø 11/10mm		
<b>accessories for</b>	500065		
	<b>Part No.</b>	500314	<b>Ref. No.</b> —
	coupling ø 40mm shaft diameter 10/11mm		
	<b>Part No.</b>	520158	<b>Ref. No.</b> —
	elastic coupling ø 40mm rubber		





1			
<b>Part No.</b>	500064	<b>Ref. No.</b>	1220100007 V509/1
<b>description</b>	pump head PO204 FLUID-O-TECH L 82mm 200l/h connection 3/8" GAS with bypass brass clip connection for coffee machine shaft ø 4.8x11mm		
<b>accessories for</b>	500064		
	<b>Part No.</b>	520126	<b>Ref. No.</b> —
	clamp for pump/motor		

### vibration pumps



1			
<b>Part No.</b>	500217	<b>Ref. No.</b>	1220300001 MG044
<b>description</b>	vibration pump type 1106PAALB2N 230V 50Hz 70W inlet ø 1/8" IT outlet ø 1/8" IT outlet conical L 129mm with bypass FLUID-O-TECH		
<b>spare parts for</b>	500217		
	<b>Part No.</b>	520250	<b>Ref. No.</b> —
	by-pass thread 1/8" IT T2: M12x1 IG		



1			
<b>Part No.</b>	500123	<b>Ref. No.</b>	1220300001 MG044
<b>description</b>	vibration pump type 1106PAALM1N 230V 50Hz 70W inlet ø 1/8" IT outlet ø 1/8" IT outlet conical L 129mm FLUID-O-TECH		
<b>accessories for</b>	500123		
	<b>Part No.</b>	371090	<b>Ref. No.</b> —
	power socket plug type DIN 43650A screw		
	<b>Part No.</b>	371120	<b>Ref. No.</b> —
	diode type IN5408		
	<b>Part No.</b>	390698	<b>Ref. No.</b> —
	thermal fuse switch-off temp. 110°C suitable for ULKA pump		

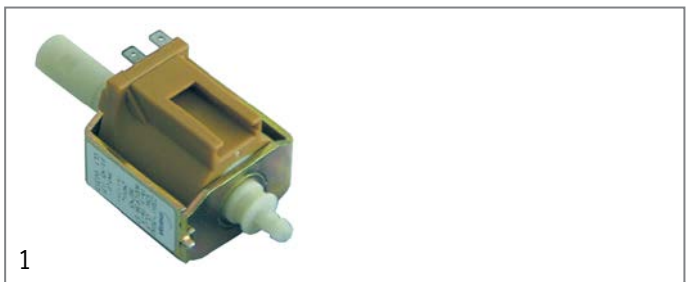

1			
<b>Part No.</b>	500219	<b>Ref. No.</b>	V080/1
<b>description</b>	vibration pump type CP.3A.958.1/ST 230V 65W 50Hz inlet ø 6 outlet ø 1/8" IT EATON (INVENSYS) L 123mm		

## condensators & interference suppression filters

### operating capacitors

#### plastic



1			
<b>Part No.</b>	365019	<b>Ref. No.</b>	A3200030
<b>description</b>	operating capacitor capacity 20µF 400V tolerance 5% 50/60Hz ambient temperature max. -25 to +85°C ø 39.5mm L 70mm M8 plastic connection male faston 6.3mm 16.10.25. protection		



## equipment-specific units

## for espresso machines

## filter holders

## filter holders standard

## filter holders (complete)



1

<b>Part No.</b>	525097	<b>Ref. No.</b>	A2200079
<b>description</b>	filter holder 2-way complete ID ø 61.8mm outlet distance 55mm mounting ø 82.4		



1

<b>Part No.</b>	526832	<b>Ref. No.</b>	2200100028 GR767/1
<b>description</b>	filter holder single ID ø 61.5mm mounting ø 82.7		
<b>For models:</b>	Eclisse, Ten, Twenty, Zola-1, Zola-2		

## filter holder without spout



1

<b>Part No.</b>	525977	<b>Ref. No.</b>	N/A
<b>description</b>	filter holder suitable for CREM-EXPOBAR/WEGA/GRIMAC/SANRAMO without outlet mounting ø 83mm outlet 3/8" ID ø 61.5mm wedge height 10mm wedge position horizontal number of wedges 2 lever inclined		

## filter holders short



1

<b>Part No.</b>	526831	<b>Ref. No.</b>	1200100021 GR767 W561
<b>description</b>	filter holder mounting ø 82.7mm outlet 3/8" ID ø 61.5mm handle M12x1.75 wedge height 10.5mm wedge position horizontal number of wedges 2 lever straight chrome-plated brass		
<b>For models:</b>	Eclisse, Ten, Twenty, Zola-1, Zola-2		

## handles

## with external thread



1

<b>Part No.</b>	529045	<b>Ref. No.</b>	GRC640
<b>description</b>	handle ø 35mm thread M12x1.75 thread L 15mm L 125mm black		

## filters

## for 1 cup



1

<b>Part No.</b>	526261	<b>Ref. No.</b>	A2200221
<b>description</b>	coffee filter ø 70mm mounting ø 60.5mm H 20.5mm cups 1 amount of coffee 6.5g		



1

<b>Part No.</b>	529011	<b>Ref. No.</b>	A2200028
<b>description</b>	coffee filter ø 70mm mounting ø 60mm H 24.5mm cups 1 amount of coffee 7g perforation ø 0.4mm		

## for 2 cups



1

<b>Part No.</b>	529197	<b>Ref. No.</b>	A2200029
<b>description</b>	coffee filter ø 70mm mounting ø 60mm H 24.5mm cups 2 amount of coffee 14g		

## filter holder springs



1

<b>Part No.</b>	526833	<b>Ref. No.</b>	1180100050 F094 GR766
<b>description</b>	filter holder spring L 76mm W 62mm wire gauge ø 1mm for espresso filter holder		
<b>For models:</b>	Eclisse, Ten, Twenty, Zola-1, Zola-2		



## brewing units

## shower screens

## flat



1

<b>Part No.</b>	529228	<b>Ref. No.</b>	A2200235
<b>description</b>	shower screen $\varnothing$ 51.6mm hole $\varnothing$ 6.2mm		

## with upstand



1

<b>Part No.</b>	528417	<b>Ref. No.</b>	1070100007 A2200031 F277 GR761
<b>description</b>	shower screen $\varnothing$ 58mm H 19mm		
<b>For models:</b>	Eclisse, Ten, Twenty, Zola-1, Zola-2		

## filter holder gaskets

## flat

## with internal notch



1

<b>Part No.</b>	526269	<b>Ref. No.</b>	1110600020
<b>description</b>	filter holder gasket D1 $\varnothing$ 71mm D2 $\varnothing$ 56mm H 8.5mm with inside notch Qty 1 pcs		



1

<b>Part No.</b>	525105	<b>Ref. No.</b>	A1200181
<b>description</b>	filter holder gasket with inside notch D1 $\varnothing$ 72mm D2 $\varnothing$ 56mm H 8mm with inside notch Qty 1 pcs		

## standard



1

<b>Part No.</b>	528031	<b>Ref. No.</b>	A1200006
<b>description</b>	filter holder gasket D1 $\varnothing$ 73mm D2 $\varnothing$ 57mm H 8.5mm rubber Qty 1 pcs		



1

<b>Part No.</b>	525104	<b>Ref. No.</b>	A1200007
<b>description</b>	filter holder gasket D1 $\varnothing$ 73mm D2 $\varnothing$ 57mm H 8mm Qty 1 pcs		

## with bevel 45x2



1

<b>Part No.</b>	526834	<b>Ref. No.</b>	1110600035 GR763 W556
<b>description</b>	filter holder gasket with bevel 45x2 D1 $\varnothing$ 73mm D2 $\varnothing$ 57mm H 8.4mm		
<b>For models:</b>	Eclisse, Ten, Twenty, Zola-1, Zola-2		

## shim gaskets



1

<b>Part No.</b>	525103	<b>Ref. No.</b>	A1200033
<b>description</b>	shim gasket D1 $\varnothing$ 72mm D2 $\varnothing$ 58mm thickness 0.6mm paper Qty 1 pcs		



brewing units with solenoid valve

universal



1	<b>Part No.</b>	525495	<b>Ref. No.</b>	1200500018 GR500C
	<b>description</b>	brewing unit for solenoid valve model E61		
	<b>For models:</b>	Eclisse, Ten, Twenty, Zola-1, Zola-2		
	<b>spare parts for</b>	525495		
	<b>Part No.</b>	529081	<b>Ref. No.</b>	—
	<b>description</b>	water distributor ø 30mm hole ø 1.5mm H 15mm ET M10x1 grooves 6 2.5mm brass		
	<b>accessories for</b>	525495		
	<b>Part No.</b>	370057	<b>Ref. No.</b>	—
	<b>description</b>	solenoid valve 3-ways 230VAC body outer cone DN 1.2mm slide-on receptacle DIN -20° up to 140°C PARKER type series VE-128 coil type ZB09 membranes ruby p max 10bar brass flange 32x32mm		
	<b>Part No.</b>	525984	<b>Ref. No.</b>	—
	<b>description</b>	filter holder suitable for AURORA/BRASILIA/FAEMA without outlet mounting ø 82.5mm outlet 3/8" ID ø 62mm wedge height 10.5mm wedge position horizontal number of wedges 2 lever straight		
	<b>Part No.</b>	528030	<b>Ref. No.</b>	—
	<b>description</b>	filter holder gasket D1 ø 72.7mm D2 ø 57.2mm H 8mm Qty 1 pcs		
	<b>Part No.</b>	528165	<b>Ref. No.</b>	—
	<b>description</b>	group gasket L 76mm W 72mm thickness 2.5mm aperture 26x64mm hole distance 55mm		
	<b>Part No.</b>	528417	<b>Ref. No.</b>	1070100007 A2200031 F277 GR761
	<b>description</b>	shower screen ø 58mm H 19mm		

brewing units manual

components

drain units

drain valves

1			
<b>Part No.</b>	526002	<b>Ref. No.</b>	A2200208
<b>description</b>	valve support ø 16mm L 27mm brass shaft triangular D1 ø 10mm D2 ø 7mm		

gaskets

1			
<b>Part No.</b>	529795	<b>Ref. No.</b>	1110100039 A1200160 F001 GR795
<b>description</b>	gasket D1 ø 13mm D2 ø 4mm thickness 4mm coffee machine		
<b>For models:</b>	Eclisse, Ten, Twenty, Zola-1, Zola-2		

1			
<b>Part No.</b>	526488	<b>Ref. No.</b>	1110100042 F005 GR740 GR751
<b>description</b>	gasket D1 ø 13mm ID ø 4mm thickness 4mm EPDM		
<b>For models:</b>	Eclisse, Ten, Twenty, Zola-1, Zola-2		

springs

1			
<b>Part No.</b>	527935	<b>Ref. No.</b>	A2200209
<b>description</b>	compression spring ø 14.6mm L 33mm wire gauge ø 2mm		

1			
<b>Part No.</b>	526813	<b>Ref. No.</b>	1180100193 GR788 W549
<b>description</b>	compression spring ø 15mm L 28mm wire gauge ø 1.8mm		
<b>For models:</b>	Eclisse, Ten, Twenty, Zola-1, Zola-2		

camshafts

1			
<b>Part No.</b>	527940	<b>Ref. No.</b>	A2200188
<b>description</b>	camshaft shaft ø 8mm shaft intake ø 6.2mm L 86.5mm W 20mm H 17mm thread M6 brass		



1			
<b>Part No.</b>	526819	<b>Ref. No.</b>	1200700016 GR784
<b>description</b>	camshaft shaft ø 8mm shaft intake ø 7mm L 84.5mm W 21mm H 17mm thread 4.9 SS		
<b>For models:</b>	Eclisse, Ten, Twenty, Zola-1, Zola-2		



## valves



1

<b>Part No.</b>	526008	<b>Ref. No.</b>	A2200178
<b>description</b>	valve group outflow L 54.3mm ED ø 16mm shaft ø 4.5mm brass		
<b>accessories for</b>	526008		
	<b>Part No.</b>	526003	<b>Ref. No.</b> —
	compression spring ø 13.8mm L 54.5mm wire gauge ø 1.5mm windings 10 drain valve		
	<b>Part No.</b>	532550	<b>Ref. No.</b> —
	O-ring NBR 787/70 thickness 2.62mm ID ø 9.13mm Qty 10 pcs		



1

<b>Part No.</b>	526007	<b>Ref. No.</b>	A2200180
<b>description</b>	valve group supply L 52.8mm ED ø 16mm shaft triangular		

## components

## nozzles

## with thread



1

<b>Part No.</b>	528486	<b>Ref. No.</b>	A2200174
<b>description</b>	nozzle bore ø 0.7mm thread M6x0.75 L 9mm WS 7		



1

<b>Part No.</b>	526491	<b>Ref. No.</b>	1201600004 F212 GR715
<b>description</b>	nozzle bore ø 0.8mm thread M6x0.75 L 9mm		
<b>For models:</b>	Eclisse, Ten, Twenty, Zola-1, Zola-2		

## springs



1

<b>Part No.</b>	526561	<b>Ref. No.</b>	A2200192
<b>description</b>	compression spring ø 14.3mm L 21mm wire gauge ø 1.8mm		

## water dispersions

## water dispersions

## group 3



1

<b>Part No.</b>	527609	<b>Ref. No.</b>	AS101
<b>description</b>	water distributor ø 56.5-59mm conical H 10mm 8 holes hole ø 1.3mm mounting ø 5.6mm brass		

## expansion valves

## with hose connection



1

<b>Part No.</b>	525096	<b>Ref. No.</b>	A1300028 A1300113
<b>description</b>	expansion valve T1: 1/8" ET hose ø 9mm total length 47mm		



1

<b>Part No.</b>	525703	<b>Ref. No.</b>	A1300028 A1300113
<b>description</b>	expansion valve T1: 1/8" ET hose ø 9mm total length 47mm		

## gasket supports



1

<b>Part No.</b>	526017	<b>Ref. No.</b>	A2200203
<b>description</b>	gasket support D1 ø 16mm D2 ø 10mm ID ø 7mm L 25mm square brass		

## compression springs



1

<b>Part No.</b>	526812	<b>Ref. No.</b>	1180100053 F097 GR749
<b>description</b>	compression spring ø 13.3mm L 42.5mm wire gauge ø 1.5mm		
<b>For models:</b>	Eclisse, Ten, Twenty, Zola-1, Zola-2		



drain pans

drain pans



1

<b>Part No.</b>	526821	<b>Ref. No.</b>	1210500016 GR126
<b>description</b>	drain pan L 102mm ø 79mm H 37mm connection 3/8" hose ø 15mm		
<b>For models:</b>	Eclisse, Ten, Twenty, Zola-1, Zola-2		



1

<b>Part No.</b>	527946	<b>Ref. No.</b>	A1600002
<b>description</b>	drain pan L 69mm W 79mm H 54mm hose ø 14mm		



1

<b>Part No.</b>	526564	<b>Ref. No.</b>	A1600134
<b>description</b>	drain pan ø 60mm H 46mm hole ø 20mm hose ø 10mm		

aerators and air bleeders



1

<b>Part No.</b>	527981	<b>Ref. No.</b>	A1300007
<b>description</b>	aerator and air bleeder connection 1/4"		

steam/water taps

steam/water taps



1

<b>Part No.</b>	526829	<b>Ref. No.</b>	2200400036 GR119
<b>description</b>	steam tap L 145mm T1: 1/4" T2: 3/8"		
<b>For models:</b>	Eclisse, Ten, Twenty, Zola-1, Zola-2		



1

<b>Part No.</b>	525098	<b>Ref. No.</b>	A2200021
<b>description</b>	steam/water tap with gasket, spring and bush inlet 3/8" outlet 3/8" shaft 6.5x8 shaft L 30mm brass		

steam taps

steam taps (complete)



1

<b>Part No.</b>	525239	<b>Ref. No.</b>	GR118
<b>description</b>	steam tap inlet 3/8" outlet 3/8"		
<b>For models:</b>	Eclisse, Ten, Twenty, Zola-1, Zola-2		



1

<b>Part No.</b>	527954	<b>Ref. No.</b>	A2200066 F579
<b>description</b>	steam tap mounting pos. external inlet 3/8" outlet 3/8" chrome-plated brass		



1

<b>Part No.</b>	525094	<b>Ref. No.</b>	A2200048
<b>description</b>	steam tap with lever inlet 3/8" outlet 3/8" chrome-plated brass		





			
1			
<b>Part No.</b>	526492	<b>Ref. No.</b>	1200400045 GR329
<b>description</b>	steam tap with pipe inlet 3/8" outlet 3/8" chrome-plated brass pipe length 265mm tube ø 8mm		
<b>For models:</b>	Zola-2		

			
1			
<b>Part No.</b>	526830	<b>Ref. No.</b>	1200400038 GR111
<b>description</b>	steam tap with steam pipe inlet 3/8" outlet 3/8" pipe length 190mm tube ø 8mm		
<b>For models:</b>	Eclisse, Ten, Twenty, Zola-1, Zola-2		

## miscellaneous

			
1			
<b>Part No.</b>	526017	<b>Ref. No.</b>	A2200203
<b>description</b>	gasket support D1 ø 16mm D2 ø 10mm ID ø 7mm L 25mm square brass		

## components

## gaskets

			
1			
<b>Part No.</b>	527970	<b>Ref. No.</b>	1110300034 GR361
<b>description</b>	flat gasket PTFE ED ø 24mm ID ø 18mm thickness 2mm Qty 1 pcs		
<b>For models:</b>	Zola-2		

			
1			
<b>Part No.</b>	529795	<b>Ref. No.</b>	1110100039 A1200160 F001 GR795
<b>description</b>	gasket D1 ø 13mm D2 ø 4mm thickness 4mm coffee machine		
<b>For models:</b>	Eclisse, Ten, Twenty, Zola-1, Zola-2		

			
1			
<b>Part No.</b>	526488	<b>Ref. No.</b>	1110100042 F005 GR740 GR751
<b>description</b>	gasket D1 ø 13mm ID ø 4mm thickness 4mm EPDM		
<b>For models:</b>	Eclisse, Ten, Twenty, Zola-1, Zola-2		

			
1			
<b>Part No.</b>	526487	<b>Ref. No.</b>	GR353
<b>description</b>	gasket D1 ø 15.5mm D2 ø 7.5mm thickness 4mm EPDM		
<b>For models:</b>	Zola-2		

## gasket supports

			
1			
<b>Part No.</b>	525175	<b>Ref. No.</b>	GR741
<b>description</b>	valve ø hexagon 16mm L 14mm brass		
<b>For models:</b>	Eclisse, Ten, Twenty, Zola-1, Zola-2		

## springs

			
1			
<b>Part No.</b>	525093	<b>Ref. No.</b>	1180100097 A2200002 GR362
<b>description</b>	compression spring ø 10.6mm L 29.5mm wire gauge ø 1.4mm		
<b>For models:</b>	Zola-2		

			
1			
<b>Part No.</b>	527968	<b>Ref. No.</b>	1180100076 F777 GR742
<b>description</b>	compression spring ø 12.5mm L 31mm wire gauge ø 1.8mm		
<b>For models:</b>	Eclisse, Ten, Twenty, Zola-1, Zola-2		



			
1			
<b>Part No.</b>	527969	<b>Ref. No.</b>	GR359
<b>description</b>	compression spring $\varnothing$ 8mm L 21mm wire gauge $\varnothing$ 0.4mm		
<b>For models:</b>	Zola-2		

valve bodies

			
1			
<b>Part No.</b>	526818	<b>Ref. No.</b>	1201500068 C411M GRT110
<b>description</b>	valve body for steam-/water-tap		
<b>For models:</b>	Eclisse, Ten, Twenty, Zola-1, Zola-2		

screw connections

			
1			
<b>Part No.</b>	526851	<b>Ref. No.</b>	GR040 GR40
<b>description</b>	screw connection for steam-/water-tap T1: 3/8" T2: M20x1.5 ID $\varnothing$ 8mm WS 30 nickel-plated brass		
<b>For models:</b>	Eclisse, Ten, Twenty, Zola-1, Zola-2		

steam/water pipes

steam pipes

			
1			
<b>Part No.</b>	525102	<b>Ref. No.</b>	A2000090
<b>description</b>	steam pipe H 150mm W 70mm tube $\varnothing$ 8mm chrome-plated brass		

			
1			
<b>Part No.</b>	526493	<b>Ref. No.</b>	1260200034 GR348
<b>description</b>	steam pipe H 268mm tube $\varnothing$ 8mm IT 3/8"		
<b>For models:</b>	Zola-2		

			
1			
<b>Part No.</b>	525100	<b>Ref. No.</b>	A2200014
<b>description</b>	steam pipe mounting pos. left thread 3/8" H 200mm tube $\varnothing$ 8mm chrome-plated brass		

			
1			
<b>Part No.</b>	525101	<b>Ref. No.</b>	A2200015
<b>description</b>	steam pipe mounting pos. right thread 3/8" H 200mm tube $\varnothing$ 8mm chrome-plated brass		

			
1			
<b>Part No.</b>	526494	<b>Ref. No.</b>	1260200031 GR211
<b>description</b>	steam pipe thread 3/8" H 195mm L 220mm $\varnothing$ 14.5mm tube $\varnothing$ 8mm suitable for GRIMAC		
<b>For models:</b>	Eclisse, Ten, Twenty, Zola-1, Zola-2		

nozzles for steam pipes

			
1			
<b>Part No.</b>	525099	<b>Ref. No.</b>	A2200044
<b>description</b>	steam nozzle thread M10x1 $\varnothing$ 12mm L 14mm thread L 6mm 4 holes bore $\varnothing$ 1.5mm chrome-plated brass		



## nozzles for water pipes

## nozzles for water pipes



1

<b>Part No.</b>	525095	<b>Ref. No.</b>	A2200012
<b>description</b>	nozzle D1 ø 24mm H 30mm thread M10x1 int. ø 1 9mm		

## accessories

## bushes



1

<b>Part No.</b>	526485	<b>Ref. No.</b>	1110300003 GR269
<b>description</b>	bush D1 ø 14.5mm D2 ø 11.5mm H 8mm PTFE ID ø 9mm		
<b>For models:</b>	Eclisse, Ten, Twenty, Zola-1, Zola-2		



1

<b>Part No.</b>	526490	<b>Ref. No.</b>	1300900111 GR776 W604
<b>description</b>	bush D1 ø 14.5mm D2 ø 8.35mm H 3.6mm brass ID ø 7mm		
<b>For models:</b>	Eclisse, Ten, Twenty, Zola-1, Zola-2		

## gaskets



1

<b>Part No.</b>	528402	<b>Ref. No.</b>	A1200030
<b>description</b>	O-ring Viton thickness 2.62mm ID ø 10.78mm Qty 1 pcs		



1

<b>Part No.</b>	528231	<b>Ref. No.</b>	A1200028
<b>description</b>	O-ring Viton thickness 2.62mm ID ø 12.37mm Qty 1 pcs		

## springs



1

<b>Part No.</b>	526815	<b>Ref. No.</b>	1180100012 AS035 GR775
<b>description</b>	compression spring ø 11.5mm L 16.5mm wire gauge ø 1.5mm		
<b>For models:</b>	Eclisse, Ten, Twenty, Zola-1, Zola-2		

## tube handles



1

<b>Part No.</b>	528625	<b>Ref. No.</b>	1110100148 GR130
<b>description</b>	tube handle L 35mm rubber ID ø 8mm		
<b>For models:</b>	Eclisse, Ten, Twenty, Zola-1, Zola-2		

## union nuts



1

<b>Part No.</b>	528826	<b>Ref. No.</b>	A2200036
<b>description</b>	union nut thread 3/8" L 21mm hole ø 12.5mm chrome-plated brass		

## gaskets

## flat gaskets

## rubber gaskets



1

<b>Part No.</b>	525107	<b>Ref. No.</b>	A1200155
<b>description</b>	flat gasket rubber ED ø 16mm ID ø 8mm thickness 4mm Qty 1 pcs		

## fine filters

## fine filters



1

<b>Part No.</b>	529979	<b>Ref. No.</b>	A2200175
<b>description</b>	fine filter ø 8.8mm H 22mm		



1

<b>Part No.</b>	528946	<b>Ref. No.</b>	1090500003 GR714 W527
<b>description</b>	fine filter pipe ø 8.5mm H 22mm		
<b>For models:</b>	Eclisse, Ten, Twenty, Zola-1, Zola-2		

## intake valves

## intake valves





1

<b>Part No.</b>	526820	<b>Ref. No.</b>	2200600006 GR001C
<b>description</b>	intake valve complete		





accessories			
springs			
			
1			
<b>Part No.</b>	526560	<b>Ref. No.</b>	A2200177
<b>description</b>	compression spring ø 14.3mm L 46mm wire gauge ø 1.5mm		

miscellaneous			
			
1			
<b>Part No.</b>	528422	<b>Ref. No.</b>	GR360 GR747
<b>description</b>	ball ø 8mm SS		
<b>For models:</b>	Eclisse, Ten, Twenty, Zola-1, Zola-2		

level glasses			
level glasses			
gaskets			
			
1			
<b>Part No.</b>	529408	<b>Ref. No.</b>	GR734 GR850
<b>description</b>	gasket D1 ø 16mm D2 ø 10mm H 8mm water level glass		
<b>For models:</b>	Eclisse, Ten, Twenty, Zola-1, Zola-2		

level glass pipes			
			
1			
<b>Part No.</b>	527990	<b>Ref. No.</b>	1250300034 GR270
<b>description</b>	water level tube ø 11mm H 140mm ID ø 8mm marking Min/Max red		
<b>For models:</b>	Eclisse, Ten, Twenty, Zola-1, Zola-2		

			
1			
<b>Part No.</b>	531177	<b>Ref. No.</b>	A1400008
<b>description</b>	water level tube ø 11mm H 170mm ID ø 8mm		

non-return valves			
gaskets			
			
1			
<b>Part No.</b>	526489	<b>Ref. No.</b>	GR758
<b>description</b>	gasket D1 ø 14.9mm D2 ø 6mm total length 10mm L1 5mm L2 5mm		
<b>For models:</b>	Eclisse, Ten, Twenty, Zola-1, Zola-2		

compression springs			
			
1			
<b>Part No.</b>	526811	<b>Ref. No.</b>	1180100081 FS214 GR748
<b>description</b>	compression spring ø 7.8mm L 35mm wire gauge ø 0.5mm		
<b>For models:</b>	Eclisse, Ten, Twenty, Zola-1, Zola-2		

pistons			
			
1			
<b>Part No.</b>	526009	<b>Ref. No.</b>	A2200215
<b>description</b>	piston for non-return valve with O-ring ø 12mm L 20mm		

complete			
			
1			
<b>Part No.</b>	529335	<b>Ref. No.</b>	A1300056
<b>description</b>	non-return valve inlet 1/8" outlet 1/8" L 30mm		

			
1			
<b>Part No.</b>	527978	<b>Ref. No.</b>	A1300109
<b>description</b>	non-return valve inlet 3/8" outlet 3/8" L 38mm		

screw connections			
washers			
			
1			
<b>Part No.</b>	526483	<b>Ref. No.</b>	1110400017 GR727
<b>description</b>	throttle disc D1 ø 18.3mm D2 ø 4mm thickness 1.6mm copper		
<b>For models:</b>	Eclisse, Ten, Twenty, Zola-1, Zola-2		



## for coffee grinders

## grinding burrs

## grinding burrs straight

## standard



1

<b>Part No.</b>	527227	<b>Ref. No.</b>	260001 260003 A3200063
<b>description</b>	grinding burrs pair turn direction right D1 ø 63mm ID ø 38mm H 9.5mm tooth spacing 3mm hole ø 5.5mm bore ø 8.5mm mounting ø 48 straight suitable for FIORENZATO		



1

<b>Part No.</b>	527228	<b>Ref. No.</b>	260001 260003 A3200083
<b>description</b>	grinding burrs pair turn direction right D1 ø 83mm ID ø 45mm H 10mm tooth spacing 4mm hole ø 5.4mm bore ø 10mm mounting ø 64.5 straight suitable for FIORENZATO		

## grinding burrs conical



1

<b>Part No.</b>	527248	<b>Ref. No.</b>	MAC076
<b>description</b>	grinding burrs pair turn direction right D1 ø 40mm D2 ø 32mm H 20mm shaft ø 10mm with flute suitable for SAECO		

## grinding burrs holders



1

<b>Part No.</b>	527260	<b>Ref. No.</b>	170090 340182
<b>description</b>	grinding burr holder D1 ø 63mm D2 ø 80mm H 31mm type T80 suitable for FIORENZATO		



1

<b>Part No.</b>	527261	<b>Ref. No.</b>	340183
<b>description</b>	grinding burr holder D1 ø 83mm D2 ø 90mm H 34mm type T45 suitable for FIORENZATO		

## miscellaneous



1

<b>Part No.</b>	802047	<b>Ref. No.</b>	160097
<b>description</b>	equipment foot rubber ømm H 22mm mounting measurements 31x18mm T80 Qty 1 pcs		

## dosing containers

## dosing containers (complete)



1

<b>Part No.</b>	527508	<b>Ref. No.</b>	340123 RMT480006 RMUNI0007
<b>description</b>	dosing unit ø 120mm suitable for T80		

## dosing container lids



1

<b>Part No.</b>	527320	<b>Ref. No.</b>	160064
<b>description</b>	lid for dosing container mounting ø 114mm ø 122mm H 22mm suitable for M80		



1

<b>Part No.</b>	525166	<b>Ref. No.</b>	A320008
<b>description</b>	lid for dosing container mounting ø 116mm ø 130mm H 25mm		



1

<b>Part No.</b>	527323	<b>Ref. No.</b>	160078
<b>description</b>	lid for dosing container mounting ø 130mm ø 135mm H 24mm		

adjusting screws



1

<b>Part No.</b>	527500	<b>Ref. No.</b>	340120
<b>description</b>	adjusting screw for dosing container thread M8 L 40mm plastic		

springs

group 1



1

<b>Part No.</b>	525110	<b>Ref. No.</b>	A3200049
<b>description</b>	tension spring ø 7.5mm total length 42mm wire gauge ø 0.8mm L1 29mm		

glass cylinders



1

<b>Part No.</b>	525167	<b>Ref. No.</b>	A320009
<b>description</b>	glass cylinder for dosing container ø 125mm H 53mm plexiglas		



1

<b>Part No.</b>	527322	<b>Ref. No.</b>	160083 340231
<b>description</b>	glass cylinder ø 122mm H 10mm plexiglas		



1

<b>Part No.</b>	527326	<b>Ref. No.</b>	160079
<b>description</b>	glass cylinder ø 132mm H 75mm plexiglas		

levers

levers



1

<b>Part No.</b>	527507	<b>Ref. No.</b>	340159
<b>description</b>	lever complete L 110mm shaft ø 8mm plastic		

coffee presses

components

holders



1

<b>Part No.</b>	525113	<b>Ref. No.</b>	A3200002
<b>description</b>	bracket H 22mm L 65mm plastic		

pressers



1

<b>Part No.</b>	525112	<b>Ref. No.</b>	A3200001
<b>description</b>	coffee press ø 55mm H 34mm plastic		

coffee presses



1

<b>Part No.</b>	527506	<b>Ref. No.</b>	160061
<b>description</b>	coffee press ø 57mm L 83mm H 41mm plastic		





## automatic grinding

## automatic grinding



<b>Part No.</b>	525114	<b>Ref. No.</b>	A3200084
-----------------	--------	-----------------	----------

<b>description</b>	housing for microswitch $\varnothing$ 116mm H 45mm plastic
--------------------	--

## sector plates



<b>Part No.</b>	527502	<b>Ref. No.</b>	160073
-----------------	--------	-----------------	--------

<b>description</b>	sector plates plastic
--------------------	-----------------------

## stars

## central



<b>Part No.</b>	527503	<b>Ref. No.</b>	340196
-----------------	--------	-----------------	--------

<b>description</b>	star mounting pos. centre/bottom
--------------------	----------------------------------

## upper



<b>Part No.</b>	527501	<b>Ref. No.</b>	160072
-----------------	--------	-----------------	--------

<b>description</b>	star mounting pos. upper $\varnothing$ 107mm hole $\varnothing$ 8mm H 39mm
--------------------	--

## bottom



<b>Part No.</b>	527503	<b>Ref. No.</b>	340196
-----------------	--------	-----------------	--------

<b>description</b>	star mounting pos. centre/bottom
--------------------	----------------------------------

## adjustment mechanism

## setting rings



<b>Part No.</b>	527412	<b>Ref. No.</b>	340181
-----------------	--------	-----------------	--------

<b>description</b>	setting ring mounting $\varnothing$ 95mm $\varnothing$ 111mm ID $\varnothing$ 68mm H 41mm suitable for FIORENZATO for T45 equiv. no. 340181
--------------------	---



<b>Part No.</b>	527410	<b>Ref. No.</b>	340147
-----------------	--------	-----------------	--------

<b>description</b>	setting ring $\varnothing$ 106mm ID $\varnothing$ 68mm H 30mm suitable for FIORENZATO for T80
--------------------	---

## coffee beans containers

## container lids



<b>Part No.</b>	527313	<b>Ref. No.</b>	160149
-----------------	--------	-----------------	--------

<b>description</b>	lid for coffee beans container mounting $\varnothing$ 174mm $\varnothing$ 178mm
--------------------	---



<b>Part No.</b>	527315	<b>Ref. No.</b>	160081 A3200028
-----------------	--------	-----------------	--------------------

<b>description</b>	lid for coffee beans container mounting $\varnothing$ 200mm $\varnothing$ 204mm
--------------------	---



coffee beans containers



1

<b>Part No.</b>	527312	<b>Ref. No.</b>	340066
<b>description</b>	coffee beans container 3-piece seat ø 68mm		



1

<b>Part No.</b>	527311	<b>Ref. No.</b>	340068 RMT800012
<b>description</b>	coffee beans container complete ø 175mm H 220mm seat ø 68mm container capacity 1.2kg T80		





1

<b>Part No.</b>	527314	<b>Ref. No.</b>	160080
<b>description</b>	coffee beans container ø 172mm H 222mm seat ø 67mm M80		
<b>accessories for</b>	527314		
	<b>Part No.</b>	527313	<b>Ref. No.</b> 160149
	lid for coffee beans container mounting ø 174mm ø 178mm		
	<b>Part No.</b>	527318	<b>Ref. No.</b> 160063 A3200031
	catch L 86mm W 48mm thickness 2mm plastic		
	<b>Part No.</b>	527319	<b>Ref. No.</b> 160067
	protection cap ø 60mm suitable for FIORENZATO plexiglas		



1

<b>Part No.</b>	527316	<b>Ref. No.</b>	160076 A3200027
<b>description</b>	coffee beans container ø 200mm H 255mm seat ø 67mm M1-T48		
<b>spare parts for</b>	527316		
	<b>Part No.</b>	527315	<b>Ref. No.</b> 160081 A3200028
	lid for coffee beans container mounting ø 200mm ø 204mm		
	<b>Part No.</b>	527318	<b>Ref. No.</b> 160063 A3200031
	catch L 86mm W 48mm thickness 2mm plastic		
	<b>Part No.</b>	527319	<b>Ref. No.</b> 160067
	protection cap ø 60mm suitable for FIORENZATO plexiglas		



### protection caps



1

<b>Part No.</b>	527319	<b>Ref. No.</b>	160067
<b>description</b>	protection cap ø 60mm suitable for FIORENZATO plexiglas		



1

<b>Part No.</b>	527411	<b>Ref. No.</b>	160091
<b>description</b>	protection cap ø 68mm plastic		

### locks



1

<b>Part No.</b>	527318	<b>Ref. No.</b>	160063 A3200031
<b>description</b>	catch L 86mm W 48mm thickness 2mm plastic		

### support for filter holder



1

<b>Part No.</b>	527518	<b>Ref. No.</b>	170033 170044
<b>description</b>	bracket for filter holder L 105mm W 57mm H 15mm aluminium		

### counters

#### counters



1

<b>Part No.</b>	527505	<b>Ref. No.</b>	210033
<b>description</b>	counter ø 20mm lever length 35mm for dosing unit		

### for dishwashers

#### rotation plates

#### rotation plate bearings



1

<b>Part No.</b>	519426	<b>Ref. No.</b>	LAV817
<b>description</b>	spindle for rotation plate		

## EQUIPMENT-SPECIFIC UNITS/KNOBS GRIMAC



1

<b>Part No.</b>	519427	<b>Ref. No.</b>	LAV837
<b>description</b>	spindle for rotation plate		

### door mechanics

#### locks



1

<b>Part No.</b>	512369	<b>Ref. No.</b>	LAV256
<b>description</b>	counterpart door catch		



1

<b>Part No.</b>	512160	<b>Ref. No.</b>	LAV255
<b>description</b>	door catch		

**accessories for** 512160

<b>Part No.</b>	512369	<b>Ref. No.</b>	LAV256
<b>description</b>	counterpart door catch		

### knobs

#### steam/water taps

#### steam/water taps



1

<b>Part No.</b>	111348	<b>Ref. No.</b>	221020009 GR290
<b>description</b>	knob steam ø 53mm shaft ø 8.5mm black		





1

<b>Part No.</b>	526828	<b>Ref. No.</b>	221020009 GR290
<b>description</b>	knob steam ø 53mm shaft ø 8.5mm black		

**For models:** Eclisse, Ten, Twenty, Zola-1, Zola-2



			
1			
<b>Part No.</b>	111347	<b>Ref. No.</b>	2210200011 GR295
<b>description</b>	knob steam ø 53mm shaft ø 8.5mm black/chrome		
<b>For models:</b>	Eclisse, Ten, Twenty, Zola-1, Zola-2		

			
1			
<b>Part No.</b>	111331	<b>Ref. No.</b>	2210200008 GR289
<b>description</b>	knob water ø 53mm shaft ø 8.5mm black		
<b>For models:</b>	Eclisse, Ten, Twenty, Zola-1, Zola-2		

			
1			
<b>Part No.</b>	111332	<b>Ref. No.</b>	2210200010 GR294
<b>description</b>	knob water ø 53mm shaft ø 8.5mm black/chrome		
<b>For models:</b>	Eclisse, Ten, Twenty, Zola-1, Zola-2		

			
1			
<b>Part No.</b>	111328	<b>Ref. No.</b>	A1600012
<b>description</b>	turning handle ø 44mm shaft ø 6x8mm black		

### knob dial plates

			
1			
<b>Part No.</b>	111330	<b>Ref. No.</b>	GR842
<b>description</b>	knob dial plate steam ø 20mm L 7mm black		
<b>For models:</b>	Eclisse, Ten, Twenty, Zola-1, Zola-2		

			
1			
<b>Part No.</b>	111349	<b>Ref. No.</b>	GR843
<b>description</b>	knob dial plate water ø 20mm L 7mm black		
<b>For models:</b>	Eclisse, Ten, Twenty, Zola-1, Zola-2		

### accessories

			
1			
<b>Part No.</b>	111028	<b>Ref. No.</b>	2210200003 F309 GR855
<b>description</b>	star handle shaft 7x7mm ø 64mm L 24mm black		
<b>For models:</b>	Zola-2		

			
1			
<b>Part No.</b>	111329	<b>Ref. No.</b>	GR819
<b>description</b>	star handle thread M8x1.25 ø 40mm L 27mm black		
<b>For models:</b>	Eclisse, Ten, Twenty, Zola-1, Zola-2		

### miscellaneous

			
1			
<b>Part No.</b>	527259	<b>Ref. No.</b>	1210100086 GR272
<b>description</b>	knob push-in ø 34/60mm shaft ø 5x5mm black H 21.4mm L 49mm		
<b>For models:</b>	Eclisse, Ten, Twenty, Zola-1, Zola-2		

## handles and hand wheels

### cone handles

			
1			
<b>Part No.</b>	111327	<b>Ref. No.</b>	A1600172
<b>description</b>	cone handle thread M8 ø 30mm L 66mm thermoplastic black		

### ball handles

			
1			
<b>Part No.</b>	111346	<b>Ref. No.</b>	GRT030
<b>description</b>	ball handle thread M8 ø 25mm black matt		

### star handles

			
1			
<b>Part No.</b>	111333	<b>Ref. No.</b>	A1600004
<b>description</b>	star handle shaft 7x7mm ø 60mm L 24mm black thermoplastic		





1

<b>Part No.</b>	111329	<b>Ref. No.</b>	GR819
<b>description</b>	star handle thread M8x1.25 ø 40mm L 27mm black		
<b>For models:</b>	Eclisse, Ten, Twenty, Zola-1, Zola-2		

## equipment feet and end caps

### equipment feet with stem



1

<b>Part No.</b>	802047	<b>Ref. No.</b>	160097
<b>description</b>	equipment foot rubber ømm H 22mm mounting measurements 31x18mm T80 Qty 1 pcs		

## gaskets

### O-rings

#### EPDM



1

<b>Part No.</b>	510177	<b>Ref. No.</b>	A1200039
<b>description</b>	O-ring EPDM thickness 1.78mm ID ø 7.66mm Qty 1 pcs		



1

<b>Part No.</b>	526824	<b>Ref. No.</b>	GR754
<b>description</b>	O-ring EPDM thickness 1.9mm ID ø 5.7mm Qty 1 pcs		
<b>For models:</b>	Eclisse, Ten, Twenty, Zola-1, Zola-2		



1

<b>Part No.</b>	525255	<b>Ref. No.</b>	GR364
<b>description</b>	O-ring EPDM thickness 1.9mm ID ø 7.2mm Qty 1 pcs		
<b>For models:</b>	Zola-2		



1

<b>Part No.</b>	529412	<b>Ref. No.</b>	A1200040
<b>description</b>	O-ring EPDM thickness 2.62mm ID ø 10.78mm Qty 1 pcs		

### silicone



1

<b>Part No.</b>	525388	<b>Ref. No.</b>	1110100004 MG264
<b>description</b>	O-ring silicone thickness 1.78mm ID ø 9.25mm Qty 1 pcs		

### Viton



1

<b>Part No.</b>	526369	<b>Ref. No.</b>	1110800025 C293 GR847
<b>description</b>	O-ring Viton thickness 1.78mm ID ø 10.82mm Qty 1 pcs		
<b>For models:</b>	Eclisse, Ten, Twenty, Zola-1, Zola-2		



1

<b>Part No.</b>	526822	<b>Ref. No.</b>	1110800040 F067 GR756
<b>description</b>	O-ring Viton thickness 1.9mm ID ø 8mm Qty 1 pcs		
<b>For models:</b>	Eclisse, Ten, Twenty, Zola-1, Zola-2		



1

<b>Part No.</b>	528402	<b>Ref. No.</b>	A1200030
<b>description</b>	O-ring Viton thickness 2.62mm ID ø 10.78mm Qty 1 pcs		

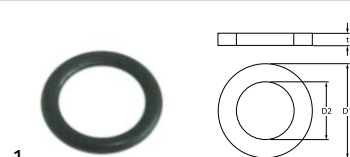
1

<b>Part No.</b>	528231	<b>Ref. No.</b>	A1200028
<b>description</b>	O-ring Viton thickness 2.62mm ID ø 12.37mm Qty 1 pcs		

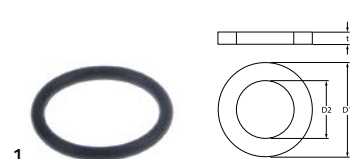

1

<b>Part No.</b>	532560	<b>Ref. No.</b>	A1200151
<b>description</b>	O-ring Viton thickness 2.62mm ID ø 20.63mm Qty 1 pcs		



1

<b>Part No.</b>	528525	<b>Ref. No.</b>	GR718
<b>description</b>	O-ring Viton thickness 3.53mm ID ø 18.64mm Qty 1 pcs		
<b>For models:</b>	Eclisse, Ten, Twenty, Zola-1, Zola-2		

sealing washers

fibre gaskets



1

<b>Part No.</b>	526484	<b>Ref. No.</b>	GR806 GRC606
<b>description</b>	flat gasket fibre ED ø 17mm ID ø 13.2mm thickness 2mm Qty 1 pcs		

rubber gaskets



1

<b>Part No.</b>	525107	<b>Ref. No.</b>	A1200155
<b>description</b>	flat gasket rubber ED ø 16mm ID ø 8mm thickness 4mm Qty 1 pcs		

PTFE gaskets



1

<b>Part No.</b>	527638	<b>Ref. No.</b>	A1200044
<b>description</b>	flat gasket PTFE ED ø 12mm ID ø 10mm thickness 1mm Qty 1 pcs		



1

<b>Part No.</b>	526661	<b>Ref. No.</b>	GR806 GRC606
<b>description</b>	flat gasket PTFE ED ø 17mm ID ø 13mm thickness 2mm Qty 1 pcs		
<b>For models:</b>	Eclisse, Ten, Twenty, Zola-1, Zola-2		



1

<b>Part No.</b>	526481	<b>Ref. No.</b>	GR716 GR755
<b>description</b>	flat gasket PTFE ED ø 21.5mm ID ø 17mm thickness 2mm Qty 1 pcs		
<b>For models:</b>	Eclisse, Ten, Twenty, Zola-1, Zola-2		



1

<b>Part No.</b>	527154	<b>Ref. No.</b>	A1200153
<b>description</b>	flat gasket PTFE ED ø 22mm ID ø 16.8mm thickness 2mm Qty 1 pcs		



1

<b>Part No.</b>	526013	<b>Ref. No.</b>	1110300046 A1200011 GR846 R204
<b>description</b>	flat gasket PTFE ED ø 22mm ID ø 17mm thickness 2mm Qty 1 pcs		
<b>For models:</b>	Eclisse, Ten, Twenty, Zola-1, Zola-2		



1

<b>Part No.</b>	527970	<b>Ref. No.</b>	1110300034 GR361
<b>description</b>	flat gasket PTFE ED ø 24mm ID ø 18mm thickness 2mm Qty 1 pcs		
<b>For models:</b>	Zola-2		



1

<b>Part No.</b>	526265	<b>Ref. No.</b>	A1200009
<b>description</b>	flat gasket PTFE ED ø 24mm ID ø 19mm thickness 2mm Qty 1 pcs		





1

<b>Part No.</b>	526482	<b>Ref. No.</b>	GR743 GR746
<b>description</b>	flat gasket PTFE ED ø 26.5mm ID ø 22mm thickness 2mm Qty 1 pcs		
<b>For models:</b>	Eclisse, Ten, Twenty, Zola-1, Zola-2		







			
1			
<b>Part No.</b>	525106	<b>Ref. No.</b>	A1200158
<b>description</b>	flat gasket PTFE ED ø 26mm ID ø 19mm thickness 2mm Qty 1 pcs		

			
1			
<b>Part No.</b>	526014	<b>Ref. No.</b>	A1200152
<b>description</b>	flat gasket PTFE ED ø 35mm ID ø 30mm thickness 2mm Qty 1 pcs		

			
1			
<b>Part No.</b>	526827	<b>Ref. No.</b>	1110300021 F055T GR719
<b>description</b>	flat gasket PTFE ED ø 36mm ID ø 30mm thickness 2.5mm Qty 1 pcs		
<b>For models:</b>	Eclisse, Ten, Twenty, Zola-1, Zola-2		

			
1			
<b>Part No.</b>	526826	<b>Ref. No.</b>	1110300016 CA020T GRC610
<b>description</b>	flat gasket PTFE ED ø 53mm ID ø 42.5mm thickness 3mm Qty 1 pcs		

			
1			
<b>Part No.</b>	528021	<b>Ref. No.</b>	1110300016 A1200015 CA020T GRC610
<b>description</b>	flat gasket PTFE ED ø 53mm ID ø 42.5mm thickness 3mm Qty 1 pcs equiv. no. 12001/02286 suitable for Astoria/Aurora/Brasilia/Wega		
<b>For models:</b>	Eclisse, Ten, Twenty		

			
1			
<b>Part No.</b>	526825	<b>Ref. No.</b>	1110300019 F043T GR709
<b>description</b>	flat gasket PTFE ED ø 58mm ID ø 43mm thickness 3mm Qty 1 pcs		
<b>For models:</b>	Zola-1, Zola-2		

## Viton gaskets

			
1			
<b>Part No.</b>	526486	<b>Ref. No.</b>	1110100044 F008 GR737
<b>description</b>	gasket Viton ED ø 16mm ID ø 8mm thickness 4mm Qty 1 pcs		
<b>For models:</b>	Eclisse, Ten, Twenty, Zola-1, Zola-2		

## special gaskets

## group gaskets

			
1			
<b>Part No.</b>	526480	<b>Ref. No.</b>	1110500119 A1200162 GR721 W539A
<b>description</b>	group gasket L 75mm W 72mm thickness 3mm aperture 27x66mm hole distance 56.5mm		
<b>For models:</b>	Eclisse, Ten, Twenty, Zola-1, Zola-2		

## springs

## compression springs

			
1			
<b>Part No.</b>	527504	<b>Ref. No.</b>	230023
<b>description</b>	compression spring ø 10.3mm L 60mm wire gauge ø 1.3mm		

			
1			
<b>Part No.</b>	525093	<b>Ref. No.</b>	1180100097 A2200002 GR362
<b>description</b>	compression spring ø 10.6mm L 29.5mm wire gauge ø 1.4mm		
<b>For models:</b>	Zola-2		

			
1			
<b>Part No.</b>	526815	<b>Ref. No.</b>	1180100012 AS035 GR775
<b>description</b>	compression spring ø 11.5mm L 16.5mm wire gauge ø 1.5mm		
<b>For models:</b>	Eclisse, Ten, Twenty, Zola-1, Zola-2		



1 			
<b>Part No.</b>	527968	<b>Ref. No.</b>	1180100076 F777 GR742
<b>description</b>	compression spring ø 12.5mm L 31mm wire gauge ø 1.8mm		
<b>For models:</b>	Eclisse, Ten, Twenty, Zola-1, Zola-2		

1 			
<b>Part No.</b>	525092	<b>Ref. No.</b>	A2200001
<b>description</b>	compression spring ø 12mm L 15mm wire gauge ø 1.5mm		

1 			
<b>Part No.</b>	526812	<b>Ref. No.</b>	1180100053 F097 GR749
<b>description</b>	compression spring ø 13.3mm L 42.5mm wire gauge ø 1.5mm		
<b>For models:</b>	Eclisse, Ten, Twenty, Zola-1, Zola-2		

1 			
<b>Part No.</b>	526814	<b>Ref. No.</b>	1180100052 F096 GR780
<b>description</b>	compression spring ø 13mm L 32.5mm wire gauge ø 1.3mm		
<b>For models:</b>	Eclisse, Ten, Twenty, Zola-1, Zola-2		

1 			
<b>Part No.</b>	526561	<b>Ref. No.</b>	A2200192
<b>description</b>	compression spring ø 14.3mm L 21mm wire gauge ø 1.8mm		

1 			
<b>Part No.</b>	526560	<b>Ref. No.</b>	A2200177
<b>description</b>	compression spring ø 14.3mm L 46mm wire gauge ø 1.5mm		

1 			
<b>Part No.</b>	526816	<b>Ref. No.</b>	1180100054 F098 GR760
<b>description</b>	compression spring ø 14.5mm L 33.4mm wire gauge ø 2mm		
<b>For models:</b>	Eclisse, Ten, Twenty, Zola-1, Zola-2		

1 			
<b>Part No.</b>	527935	<b>Ref. No.</b>	A2200209
<b>description</b>	compression spring ø 14.6mm L 33mm wire gauge ø 2mm		

1 			
<b>Part No.</b>	526817	<b>Ref. No.</b>	GR799
<b>description</b>	compression spring ø 14.8mm L 18mm wire gauge ø 1.8mm		
<b>For models:</b>	Eclisse, Ten, Twenty, Zola-1, Zola-2		

1 			
<b>Part No.</b>	526813	<b>Ref. No.</b>	1180100193 GR788 W549
<b>description</b>	compression spring ø 15mm L 28mm wire gauge ø 1.8mm		
<b>For models:</b>	Eclisse, Ten, Twenty, Zola-1, Zola-2		

1 			
<b>Part No.</b>	526811	<b>Ref. No.</b>	1180100081 FS214 GR748
<b>description</b>	compression spring ø 7.8mm L 35mm wire gauge ø 0.5mm		
<b>For models:</b>	Eclisse, Ten, Twenty, Zola-1, Zola-2		

1 			
<b>Part No.</b>	527969	<b>Ref. No.</b>	GR359
<b>description</b>	compression spring ø 8mm L 21mm wire gauge ø 0.4mm		
<b>For models:</b>	Zola-2		

## tension springs

1 			
<b>Part No.</b>	525110	<b>Ref. No.</b>	A3200049
<b>description</b>	tension spring ø 7.5mm total length 42mm wire gauge ø 0.8mm L1 29mm		





## manometers

1

			
1			
<b>Part No.</b>	541233	<b>Ref. No.</b>	S060
<b>description</b>	manometer double scale ø 60mm pressure range 0-2.5 / 0-15bar connection on the backside thread 1/8"		

			
1			
<b>Part No.</b>	541287	<b>Ref. No.</b>	S060
<b>description</b>	manometer double scale ø 60mm pressure range 0-2.5 / 0-15bar connection on the backside thread 1/8"		

			
1			
<b>Part No.</b>	541410	<b>Ref. No.</b>	A031 P052 W019
<b>description</b>	manometer double scale ø 60mm pressure range 0-2.5 / 0-15bar connection on the backside thread 1/8"		

			
1			
<b>Part No.</b>	541222	<b>Ref. No.</b>	VBM042
<b>description</b>	manometer double scale ø 60mm pressure range 0-2.5 / 0-16bar connection on the backside thread 1/8"		

			
1			
<b>Part No.</b>	541226	<b>Ref. No.</b>	AS057 SP030
<b>description</b>	manometer double scale ø 60mm pressure range 0-2.5 / 0-16bar connection on the backside thread 1/8"		

			
1			
<b>Part No.</b>	541227	<b>Ref. No.</b>	
<b>description</b>	manometer double scale ø 60mm pressure range 0-2.5 / 0-16bar connection on the backside thread 1/8"		

			
1			
<b>Part No.</b>	541708	<b>Ref. No.</b>	1250200034 GRC106
<b>description</b>	manometer double scale ø 60mm pressure range 0-2.5 / 0-16bar connection on the backside thread 1/8"		
<b>For models:</b>	Eclisse, Ten, Twenty, Zola-1, Zola-2		

			
1			
<b>Part No.</b>	541203	<b>Ref. No.</b>	F295
<b>description</b>	manometer double scale ø 63mm pressure range 0-2.5 / 0-15bar connection on the backside thread 1/8"		

			
1			
<b>Part No.</b>	541211	<b>Ref. No.</b>	C145
<b>description</b>	manometer double scale ø 63mm pressure range 0-2.5 / 0-15bar connection on the backside thread 1/8"		

			
1			
<b>Part No.</b>	541732	<b>Ref. No.</b>	1250200033 GR034S
<b>description</b>	manometer double scale ø 63mm pressure range 0-2.5 / 0-15bar connection on the backside thread 1/8" for GRIMAC		

1

<b>Part No.</b>	541266	<b>Ref. No.</b>	1250200031 GR034
<b>description</b>	manometer double scale ø 63mm pressure range 0-2.5 / 0-16bar connection on the backside thread 1/8"		



1

<b>Part No.</b>	541728	<b>Ref. No.</b>	A1400020
<b>description</b>	manometer double scale ø 63mm pressure range 0-3 / 0-18bar connection on the backside thread 1/8"		



1

<b>Part No.</b>	541279	<b>Ref. No.</b>	BF080
<b>description</b>	manometer double scale ø 63mm pressure range 0-2.5 / 0-25bar connection on the backside thread 1/8"		



1

<b>Part No.</b>	541209	<b>Ref. No.</b>	R067
<b>description</b>	manometer double scale ø 70mm pressure range 0-2.5 / 0-16bar connection thread 1/8"		



1

<b>Part No.</b>	541202	<b>Ref. No.</b>	F299 M149
<b>description</b>	manometer double scale ø 63mm pressure range 0-3 / 0-15bar connection on the backside thread 1/8"		



1

<b>Part No.</b>	541206	<b>Ref. No.</b>	F951
<b>description</b>	manometer ø 42mm pressure range 0 up to 16bar thread 1/8" marking 12 connection on the backside		



1

<b>Part No.</b>	541220	<b>Ref. No.</b>	SM098
<b>description</b>	manometer double scale ø 63mm pressure range 0-3 / 0-15bar connection on the backside thread 1/8"		



1

<b>Part No.</b>	541205	<b>Ref. No.</b>	F1069 F950
<b>description</b>	manometer ø 42mm pressure range 0 up to 2.5bar thread 1/8" marking 2 connection on the backside		



1

<b>Part No.</b>	541727	<b>Ref. No.</b>	A1400019
<b>description</b>	manometer double scale ø 63mm pressure range 0-3 / 0-18bar connection on the backside thread 1/8"		



1

<b>Part No.</b>	541217	<b>Ref. No.</b>	G119
<b>description</b>	manometer ø 49.3mm pressure range 0 up to 3bar thread 1/8" marking 2 connection on the backside		



1

<b>Part No.</b>	541221	<b>Ref. No.</b>	SM099
<b>description</b>	manometer ø 50mm pressure range 0 up to 3bar thread 1/4" marking 1-1.25 connection on the backside		



1



<b>Part No.</b>	541225	<b>Ref. No.</b>	AS058
<b>description</b>	manometer ø 51mm pressure range 0 up to 3bar thread 1/4" marking 2 connection on the backside		

1



<b>Part No.</b>	541232	<b>Ref. No.</b>	BE076
<b>description</b>	manometer ø 52mm pressure range 0 up to 3bar thread 1/4" marking 2 connection on the backside		

1



<b>Part No.</b>	541284	<b>Ref. No.</b>	G118
<b>description</b>	manometer ø 52mm pressure range 0 up to 15bar connection on the backside marking 6/7 thread 1/4"		

1



<b>Part No.</b>	541214	<b>Ref. No.</b>	G113
<b>description</b>	manometer ø 52mm pressure range 0 up to 3bar thread 1/8" connection on the backside		

1



<b>Part No.</b>	541200	<b>Ref. No.</b>	A1400042 F298
<b>description</b>	manometer ø 52mm pressure range 0 up to 3bar connection on the backside marking 0.7-1 thread 1/8"		

1



<b>Part No.</b>	541201	<b>Ref. No.</b>	A1400043 F297
<b>description</b>	manometer ø 53.5mm pressure range 0 up to 16bar connection on the backside thread 1/8"		

1



<b>Part No.</b>	541283	<b>Ref. No.</b>	G117
<b>description</b>	manometer ø 52mm pressure range 0 up to 3bar connection on the backside marking 1-1.5 thread 1/4"		

1



<b>Part No.</b>	541215	<b>Ref. No.</b>	G114
<b>description</b>	manometer ø 53mm pressure range 0 up to 16bar thread 1/8" marking 8-10 connection on the backside		

1



<b>Part No.</b>	541248	<b>Ref. No.</b>	F296
<b>description</b>	manometer ø 52mm pressure range 0 up to 3bar marking 1.6 thread 1/8"		

1



<b>Part No.</b>	541216	<b>Ref. No.</b>	G120
<b>description</b>	manometer ø 53mm pressure range 0 up to 16bar thread 1/8" marking 8-10 connection on the backside		

1

<b>Part No.</b>	541213	<b>Ref. No.</b>	C149
<b>description</b>	manometer ø 57mm pressure range 0 up to 15bar thread 1/8" marking 8-10 connection on the backside		



1

<b>Part No.</b>	541212	<b>Ref. No.</b>	C150
<b>description</b>	manometer ø 57mm pressure range 0 up to 2.5bar thread 1/8" connection on the backside		



1

<b>Part No.</b>	541275	<b>Ref. No.</b>	C142
<b>description</b>	manometer ø 57mm pressure range 0 up to 2.5bar thread 1/8" marking 1.6 connection on the backside		



1

<b>Part No.</b>	541286	<b>Ref. No.</b>	P051
<b>description</b>	manometer ø 60mm pressure range 0 up to 3bar thread 1/8" marking 1.5 connection on the backside		

## valves and tank inlets

### ball valves

#### universal

#### mini ball valves



1

<b>Part No.</b>	520722	<b>Ref. No.</b>	GR198 GRC618
<b>description</b>	ball valve connection 1/4" IT - 1/4" ET DN8 total length 39mm chrome-plated brass		
<b>For models:</b>	Eclipse, Ten, Twenty, Zola-1, Zola-2		

## water softeners

### measuring devices

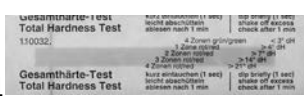

1

<b>Part No.</b>	541754	<b>Ref. No.</b>	V550
<b>description</b>	control strip type water hardness (German)		

## ancillary products

### measuring devices

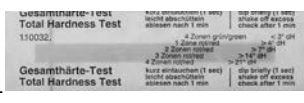

1

<b>Part No.</b>	541754	<b>Ref. No.</b>	V550
<b>description</b>	control strip type water hardness (German)		

## fastening material

### screws

#### countersunk screws



1

<b>Part No.</b>	560215	<b>Ref. No.</b>	A1100187
<b>description</b>	countersunk screw thread M5 L 14mm SS DIN 963/ISO 2009 Qty 20 pcs intake slotted head ø 9.2mm		



**GASTRO**PARTS.COM

