



**GASTROPARTS**

# Fryland

- [EN]** Equipment
- [DE]** Geräte
- [ES]** Aparatos
- [FR]** Équipement
- [IT]** Attrezzature
- [PL]** Urządzenia
- [RU]** Оборудование

✉ [gastroparts@gastroparts.com](mailto:gastroparts@gastroparts.com)

☎ +48 56 657 00 66

📘 [fb.com/gastroparts.global](https://fb.com/gastroparts.global)

**GASTROPARTS.COM**











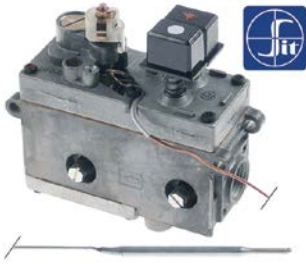













## gas thermostats

### SIT

#### 710 Minisit series



<b>Part No.</b>	101135	<b>Ref. No.</b>	03137
<b>description</b>	gas thermostat SIT type MINISIT 710 t.max. 190°C 110-190°C gas inlet 1/2" gas outlet 3/8" thermocouple connection M9x1 pilot connection M10x1 probe ø 6mm probe L 102mm capillary pipe 1050mm probe type type A3 pressure controller no pressure regulator/mbar gland nut		
<b>For models:</b>	Lt15+15g-ce		
<b>spare parts for</b>	101135		
	<b>Part No.</b>	101053	<b>Ref. No.</b> —
	magnet unit T1: M9x1 T2: M24x1 L 45mm ø 17mm suitable for Minisit		
	<b>Part No.</b>	102118	<b>Ref. No.</b> —
	probe 110-190°C probe ø 6mm probe L 102mm capillary pipe 1050mm t.max. 190°C fryer probe type type A3 suitable for MINISIT 710		
<b>accessories for</b>	101135		
	<b>Part No.</b>	100809	<b>Ref. No.</b> —
	O-ring EPDM thickness 2mm ID ø 21mm Qty 1 pcs		
	<b>Part No.</b>	100820	<b>Ref. No.</b> —
	gland duct ET M14x1.5 IT M10x0.75 probe ø max. 6.5mm WS 22		
	<b>Part No.</b>	100904	<b>Ref. No.</b> —
	locking screw M10x1 for pipe ø 4mm Qty 1 pcs		
	<b>Part No.</b>	100905	<b>Ref. No.</b> —
	locking screw M10x1 for pipe ø 6mm Qty 1 pcs		
	<b>Part No.</b>	101054	<b>Ref. No.</b> —
	magnet unit T1: M10x1 T2: M24x1 L 45mm ø 17mm suitable for Minisit		
	<b>Part No.</b>	101136	<b>Ref. No.</b> —
	piezoelectric igniter suitable for Minisit with cover cap ømm connection F6.3x0.8		
	<b>Part No.</b>	101137	<b>Ref. No.</b> —
	cover cap without piezoelectric igniter		
	<b>Part No.</b>	101267	<b>Ref. No.</b> —
	reducer IT 3/8" ET 1/2" L 21mm		
	<b>Part No.</b>	101268	<b>Ref. No.</b> —
	gas connection thread 3/8" angled with O-ring MINISIT 710		
	<b>Part No.</b>	101269	<b>Ref. No.</b> —
	gas connection thread 1/2" angled with O-ring MINISIT 710		
	<b>Part No.</b>	101270	<b>Ref. No.</b> —
	screw connection IT 3/8" ET 3/8" L 28mm		

<b>accessories for</b>	101135		
	<b>Part No.</b>	101272	<b>Ref. No.</b> —
	screw connection IT 1/2" ET 3/8" L 57mm		
	<b>Part No.</b>	101273	<b>Ref. No.</b> —
	olive for pipe ø 12mm L 9.5mm brass Qty 1 pcs suitable for universal		
	<b>Part No.</b>	101274	<b>Ref. No.</b> —
	olive for pipe ø 16mm Qty 1 pcs		
	<b>Part No.</b>	101275	<b>Ref. No.</b> —
	union screw thread 1/2" for pipe ø 16mm Qty 1 pcs		
	<b>Part No.</b>	101276	<b>Ref. No.</b> —
	union screw thread 3/8" tube ø 12mm Qty 1 pcs		
	<b>Part No.</b>	110068	<b>Ref. No.</b> —
	knob suitable for Minisit ø 37mm		

## ignition parts

### pilot burners

#### SIT

#### 100 series









<b>Part No.</b>	107139	<b>Ref. No.</b>	03139
<b>description</b>	pilot burner SIT type 100 series 1 flame nozzle ø 0.2mm gas connectionmm		
<b>For models:</b>	Lt15+15g-ce		
<b>spare parts for</b>	107139		
	<b>Part No.</b>	100854	<b>Ref. No.</b> —
	pilot burner bracket double		
	<b>Part No.</b>	100885	<b>Ref. No.</b> —
	air mixing sleeve for pilot burner Qty 1 pcs		
	<b>Part No.</b>	107160	<b>Ref. No.</b> —
	pilot burner cap SIT 1 flame Hmm Lmm Qty 1 pcs		
<b>accessories for</b>	107139		
	<b>Part No.</b>	100904	<b>Ref. No.</b> —
	locking screw M10x1 for pipe ø 4mm Qty 1 pcs		
	<b>Part No.</b>	100905	<b>Ref. No.</b> —
	locking screw M10x1 for pipe ø 6mm Qty 1 pcs		
	<b>Part No.</b>	100998	<b>Ref. No.</b> —
	pilot burner bottom part nozzle ø 0.21mm suitable for 100 series		
	<b>Part No.</b>	102110	<b>Ref. No.</b> —
	pilot tube copper pipe ø 4mm thickness 1mm L 3000mm		

Table continues overleaf



<b>accessories for</b>	107139		
	Part No.	102111	Ref. No.
			—
	pilot tube copper pipe ø 6mm thickness 1mm L 3000mm		

**POLIDORO**

**pilot burners**



<b>Part No.</b>	100076	<b>Ref. No.</b>	03479
<b>description</b>	pilot burner POLIDORO 3 flames natural gas code 29.2 gas connection 6mm		
<b>For models:</b>	SC6FG		
<b>spare parts for</b>	100076		
	Part No.	100907	Ref. No.
			—
	screw connection thread M10x1 Qty 1 pcs type SEF 1 ømm for thermocouple		
<b>accessories for</b>	100076		
	Part No.	100000	Ref. No.
			—
	pilot burner nozzle POLIDORO LPG code 22 bore ø 0.22mm Qty 1 pcs		
	Part No.	100208	Ref. No.
			—
	pilot burner nozzle POLIDORO LPG code 20 bore ø 0.2mm Qty 1 pcs		
	Part No.	100209	Ref. No.
			—
	pilot burner nozzle POLIDORO natural gas code 40 bore ø 0.4mm Qty 1 pcs		
	Part No.	100701	Ref. No.
			—
	ignition electrode connection M4 Qty 1 pcs		
	Part No.	100906	Ref. No.
			—
	screw connection thread M10x1 for ignition electrode brass Qty 1 pcs WS 10		
	Part No.	100907	Ref. No.
			—
	screw connection thread M10x1 Qty 1 pcs type SEF 1 ømm for thermocouple		
	Part No.	100908	Ref. No.
			—
	union screw thread M10x1 for pipe ø 4mm Qty 1 pcs		
	Part No.	100909	Ref. No.
			—
	union screw thread M10x1 for pipe ø 6mm Qty 1 pcs		
	Part No.	102110	Ref. No.
			—
	pilot tube copper pipe ø 4mm thickness 1mm L 3000mm		
	Part No.	102111	Ref. No.
			—
	pilot tube copper pipe ø 6mm thickness 1mm L 3000mm		
	Part No.	102508	Ref. No.
			—
	union screw thread M10x1 for pipe ø 4mm Qty 5 pcs		
	Part No.	102509	Ref. No.
			—
	union screw thread M10x1 for pipe ø 6mm Qty 5 pcs		
	Part No.	102699	Ref. No.
			—
	pilot burner nozzle POLIDORO natural gas code 25.2 bore ø 2x0.25mm Qty 1 pcs 2 bores		

<b>accessories for</b>	100076		
	Part No.	102795	Ref. No.
			—
	olive for pipe ø 4mm Qty 1 pcs		
	Part No.	102797	Ref. No.
			—
	olive for pipe ø 6mm Qty 1 pcs		
	Part No.	106703	Ref. No.
			—
	pilot burner nozzle POLIDORO natural gas code 27.2 bore ø 2x0.27mm Qty 1 pcs		
	Part No.	106704	Ref. No.
			—
	pilot burner nozzle POLIDORO LPG code 16.2 bore ø 2x0.16mm Qty 1 pcs		
	Part No.	106763	Ref. No.
			—
	pilot burner nozzle POLIDORO natural gas code 27.2A bore ø 2x 0.27mm Qty 1 pcs		
	Part No.	106859	Ref. No.
			—
	pilot burner nozzle POLIDORO LPG code 24 bore ø 0.24mm Qty 1 pcs		

**piezoelectric igniters**

**miscellaneous**



<b>Part No.</b>	107517	<b>Ref. No.</b>	03288
<b>description</b>	piezoelectric igniter suitable for Minisit connection F6.3x0.8 with cover cap ø 22mm		
<b>spare parts for</b>	107517		
	Part No.	107564	Ref. No.
			—
	piezoelectric igniter body plastic blowing connection F6.3x0.8 ø 22mm		
<b>accessories for</b>	107517		
	Part No.	100025	Ref. No.
			—
	ignition cable cable length 600mm connection ø4mm / F6.3mm		



**hinges**

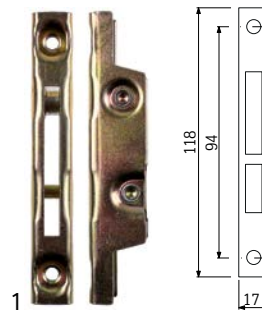

**oven hinges**



<b>Part No.</b>	700001	<b>Ref. No.</b>	03808c
<b>description</b>	opposite support L 118mm W 17mm mounting distance 94mm		

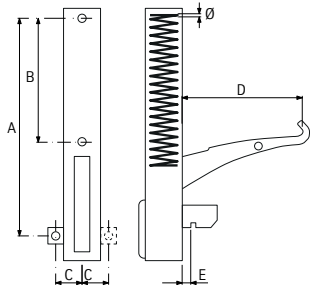

			
1			
<b>Part No.</b>	700006	<b>Ref. No.</b>	03478D
<b>description</b>	oven hinge mounting distance 173mm mounting distance 2 105mm lug mounting 14mm lever length 120mm groove distance 11mm spring thickness 3.5mm mounting ear position left spring length 112mm W 25mm		
<b>accessories for</b>	700006		
	<b>Part No.</b>	700001	<b>Ref. No.</b> 03808c
	opposite support L 118mm W 17mm mounting distance 94mm		
	<b>Part No.</b>	700007	<b>Ref. No.</b> 03478s
	oven hinge mounting distance 173mm mounting distance 2 105mm lug mounting 14mm lever length 120mm groove distance 11mm spring thickness 3.5mm mounting ear position right spring length 112mm W 25mm		

			
1			
<b>Part No.</b>	700007	<b>Ref. No.</b>	03478s
<b>description</b>	oven hinge mounting distance 173mm mounting distance 2 105mm lug mounting 14mm lever length 120mm groove distance 11mm spring thickness 3.5mm mounting ear position right spring length 112mm W 25mm		
<b>accessories for</b>	700007		
	<b>Part No.</b>	700001	<b>Ref. No.</b> 03808c
	opposite support L 118mm W 17mm mounting distance 94mm		
	<b>Part No.</b>	700006	<b>Ref. No.</b> 03478D
	oven hinge mounting distance 173mm mounting distance 2 105mm lug mounting 14mm lever length 120mm groove distance 11mm spring thickness 3.5mm mounting ear position left spring length 112mm W 25mm		

**GASTRO**PARTS.COM

