



GASTROPARTS

Forved

[EN] Equipment

[DE] Geräte

[ES] Aparatos

[FR] Équipement

[IT] Attrezzature

[PL] Urządzenia

[RU] Оборудование

✉ gastroparts@gastroparts.com

☎ +48 56 657 00 66

📘 fb.com/gastroparts.global

GASTROPARTS.COM





heating elements

heating elements for bain maries

1	
Part No.	416887
Ref. No.	SNACKRESIS01
description	heating element 1350W 230V heating circuits 1 L 385mm W 225mm connection male faston 6.3mm connection distance 110mm tube ø 8.5mm dry heating element W1 50mm W2 125mm H 22mm

1	
Part No.	416884
Ref. No.	VETRRES02 VETRRES03
description	heating element 700W 230V heating circuits 1 L 500mm W 270mm connection male faston 6.3mm connection distance 257mm connection length 20mm tube ø 6.3mm dry heating element

heating elements for fryers

2 hole fixing

1	
Part No.	416891
Ref. No.	3108
description	heating element 3000W 230V heating circuits 1 L 362mm W 65mm H 240mm L1 57mm L2 305mm H1 192mm H2 48mm thread 1/4" tube ø 8.5mm 2 hole fixing connection M5 fryer heaters windings 4

Part No.	416891	Ref. No.	3108	
description	heating element 3000W 230V heating circuits 1 L 362mm W 65mm H 240mm L1 57mm L2 305mm H1 192mm H2 48mm thread 1/4" tube ø 8.5mm 2 hole fixing connection M5 fryer heaters windings 4			
spare parts for	416891			
	Part No.	510417	Ref. No.	—
	flat gasket fibre ED ø 20mm ID ø 14mm thickness 2mm Qty 1 pcs			
accessories for	416891			
	Part No.	501318	Ref. No.	—
	nut thread 1/4" H 6.5mm SS WS 22 Qty 1 pcs			
	Part No.	503045	Ref. No.	—
	nut thread 1/4" H 4.5mm brass WS 17 Qty 1 pcs			
	Part No.	560112	Ref. No.	—
	plain washer ID ø 5.3mm ED ø 10mm thickness 1mm SS Qty 20 pcs DIN 125A for thread M5			
	Part No.	560132	Ref. No.	—
	hexagonal nut thread M5 H 4mm WS 8 SS DIN/ISO DIN 934 / ISO 4032/8673 Qty 20 pcs			

1	
Part No.	416892
Ref. No.	3108A
description	heating element 4000W 230V heating circuits 1 L 347mm W 85mm H 235mm L1 47mm L2 300mm H1 195mm H2 40mm thread 1/4" mounting distance 77mm tube ø 8.5mm 2 hole fixing connection M5 fryer heaters windings 4



Part No.	416892	Ref. No.	3108A	
description	heating element 4000W 230V heating circuits 1 L 347mm W 85mm H 235mm L1 47mm L2 300mm H1 195mm H2 40mm thread 1/4" mounting distance 77mm tube ø 8.5mm 2 hole fixing connection M5 fryer heaters windings 4			
accessories for	416892			
	Part No.	361182	Ref. No.	—
	nut thread 1/4" H 5mm nickel-plated brass WS 17 Qty 1 pcs			
	Part No.	510417	Ref. No.	—
	flat gasket fibre ED ø 20mm ID ø 14mm thickness 2mm Qty 1 pcs			
	Part No.	520228	Ref. No.	—
	tooth lock washer ID ø 15.3mm ED ø 24mm steel Qty 1 pcs for thread M14			
	Part No.	550262	Ref. No.	—
	flat gasket copper ED ø 20mm ID ø 14mm thickness 2mm			
	Part No.	560112	Ref. No.	—
	plain washer ID ø 5.3mm ED ø 10mm thickness 1mm SS Qty 20 pcs DIN 125A for thread M5			
	Part No.	560132	Ref. No.	—
	hexagonal nut thread M5 H 4mm WS 8 SS DIN/ISO DIN 934 / ISO 4032/8673 Qty 20 pcs			

1	
Part No.	416890
Ref. No.	3111
description	heating element 1670W 230V heating circuits 1 L 360mm W 85mm H 233mm L1 60mm L2 300mm H1 200mm H2 48mm thread 1/4" mounting distance 77mm tube ø 8.5mm 2 hole fixing connection M5 connection length 25mm fryer heaters windings 3

Part No.	416890	Ref. No.	3111	
description	heating element 1670W 230V heating circuits 1 L 360mm W 85mm H 233mm L1 60mm L2 300mm H1 200mm H2 48mm thread 1/4" mounting distance 77mm tube ø 8.5mm 2 hole fixing connection M5 connection length 25mm fryer heaters windings 3			
accessories for	416890			
	Part No.	361182	Ref. No.	—
	nut thread 1/4" H 5mm nickel-plated brass WS 17 Qty 1 pcs			
	Part No.	510417	Ref. No.	—
	flat gasket fibre ED ø 20mm ID ø 14mm thickness 2mm Qty 1 pcs			
	Part No.	520228	Ref. No.	—
	tooth lock washer ID ø 15.3mm ED ø 24mm steel Qty 1 pcs for thread M14			
	Part No.	550262	Ref. No.	—
	flat gasket copper ED ø 20mm ID ø 14mm thickness 2mm			

Table continues overleaf



accessories for	416890			
	Part No.	560112	Ref. No.	—
	plain washer ID \varnothing 5.3mm ED \varnothing 10mm thickness 1mm SS Qty 20 pcs DIN 125A for thread M5			
	Part No.	560132	Ref. No.	—
	hexagonal nut thread M5 H 4mm WS 8 SS DIN/ISO DIN 934 / ISO 4032/8673 Qty 20 pcs			

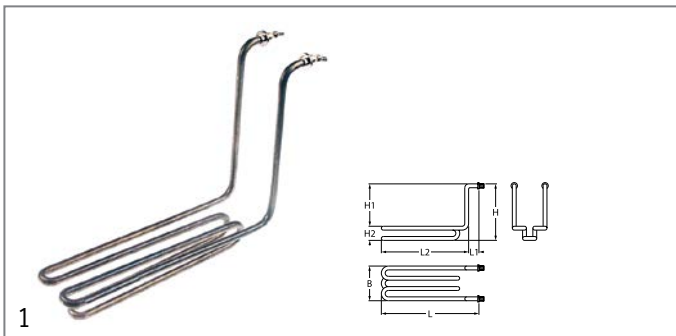

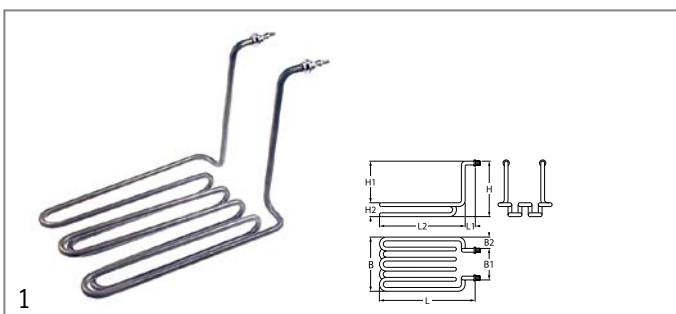

Part No.	416889	Ref. No.	3966
description	heating element 2000W 230V heating circuits 1 L 310mm W 73mm H 225mm L1 40mm L2 270mm H1 190mm H2 36mm thread 1/4" mounting distance 65mm tube \varnothing 8.5mm 2 hole fixing connection M5 fryer heaters windings 3		

accessories for	416889			
	Part No.	361182	Ref. No.	—
	nut thread 1/4" H 5mm nickel-plated brass WS 17 Qty 1 pcs			
	Part No.	510417	Ref. No.	—
	flat gasket fibre ED \varnothing 20mm ID \varnothing 14mm thickness 2mm Qty 1 pcs			
	Part No.	520228	Ref. No.	—
	tooth lock washer ID \varnothing 15.3mm ED \varnothing 24mm steel Qty 1 pcs for thread M14			
	Part No.	550262	Ref. No.	—
	flat gasket copper ED \varnothing 20mm ID \varnothing 14mm thickness 2mm			
	Part No.	560112	Ref. No.	—
	plain washer ID \varnothing 5.3mm ED \varnothing 10mm thickness 1mm SS Qty 20 pcs DIN 125A for thread M5			
	Part No.	560132	Ref. No.	—
	hexagonal nut thread M5 H 4mm WS 8 SS DIN/ISO DIN 934 / ISO 4032/8673 Qty 20 pcs			



Part No.	416888	Ref. No.	3955
description	heating element 3500W 230V heating circuits 2 L 300mm W 115mm H 232mm L1 28mm L2 272mm H1 190mm H2 42mm thread 1/4" tube \varnothing 8.5mm 2 hole fixing connection M5 immersion heater windings 5 W1 70mm W2 45mm		

accessories for	416888			
	Part No.	560112	Ref. No.	—
	plain washer ID \varnothing 5.3mm ED \varnothing 10mm thickness 1mm SS Qty 20 pcs DIN 125A for thread M5			

accessories for	416888			
	Part No.	560132	Ref. No.	—
	hexagonal nut thread M5 H 4mm WS 8 SS DIN/ISO DIN 934 / ISO 4032/8673 Qty 20 pcs			

heating elements for hot counters

1	Part No.	416883	Ref. No.	VETRESSCB80
	description	heating element 230V		

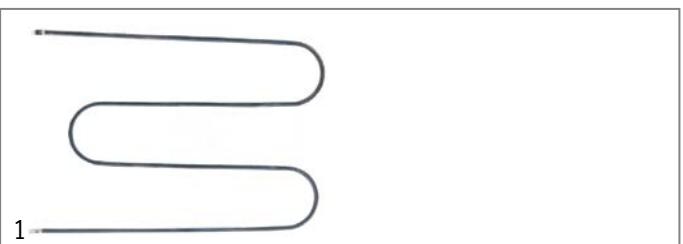

1	Part No.	416881	Ref. No.	VETRES01
	description	heating element 400W 230V heating circuits 1 L 400mm W 280mm tube \varnothing 6.3mm connection male faston 6.3mm dry heating element for vitrine		

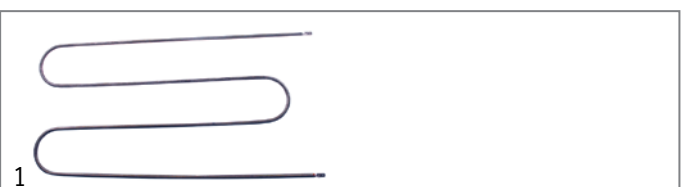

1	Part No.	416882	Ref. No.	VETRES02
	description	heating element 500W 230V heating circuits 1 L 500mm W 275mm connection distance 268mm tube \varnothing 6.3mm connection male faston 6.3mm dry heating element for vitrine		

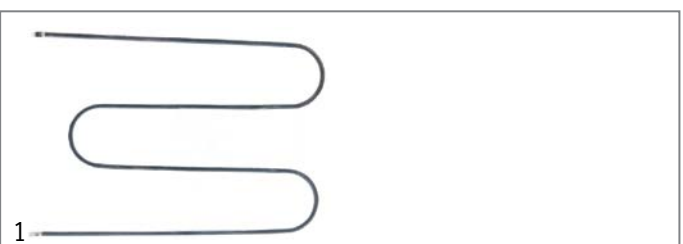

1	Part No.	419010	Ref. No.	VETRES01
	description	heating element 600W 230V heating circuits 1 L 400mm W 280mm tube \varnothing 6.3mm connection male faston 6.3mm dry heating element for vitrine		



1	Part No.	418791	Ref. No.	VETRES03
	description	heating element 900W 230V heating circuits 1 L 615mm W 265mm tube \varnothing 6.3mm connection male faston 6.3mm dry heating element		

1

Part No.	416885	Ref. No.	VETRRES04
description	heating element 900W 230V heating circuits 1 L 870mm W 345mm connection distance 339mm connection length 20mm tube ø 6.3mm connection male faston 6.3mm dry heating element		

heating elements for contact grills



1

Part No.	416877	Ref. No.	GRILLRES02
description	heating element 1000W 230V L 180mm W 192mm H 18mm L1 5mm L2 175mm W1 53mm W2 86mm tube ø 8.5mm mounting pos. upper connection M5 windings 3 dry heating element		



1

Part No.	416879	Ref. No.	GRILLRES03
description	heating element 1200W 230V L 177mm W 257mm H 18mm L1 8mm L2 160mm W1 73mm W2 111mm tube ø 8.5mm connection length 24mm mounting pos. upper connection M4 windings 4 dry heating element		



1

Part No.	416878	Ref. No.	GRILLRES01
description	heating element 1400W 230V L 198mm W 220mm H 46mm W1 60mm W2 100mm tube ø 8.5mm connection M5 connection length 24mm mounting pos. lower dry heating element windings 4		



1

Part No.	416880	Ref. No.	GRILLRES04
description	heating element 1700W 230V L 198mm W 278mm H 40mm W1 60mm W2 168mm tube ø 8.5mm connection M4 connection length 23mm mounting pos. lower dry heating element windings 5		

heating elements for salamanders/toast-



1

Part No.	416874	Ref. No.	TOSTRESOR
description	heating element 450W 115V L 344mm thread M12x1 connection length 23mm tube ø 8.5mm connection male faston 6.3mm heating circuits 1 dry heating element toaster W 8.5mm H 8.5mm		

quartz heating elements



1

Part No.	416187	Ref. No.	TOSTRES01
description	quartz heating element 400W 115V L 260mm ø 12mm connection male faston 6.3mm mounting distance 24.8mm		



1

Part No.	418625	Ref. No.	TOSTRES02
description	quartz heating element 500W 115V L 365mm ø 10mm connection male faston 6.3mm		



1

Part No.	416873	Ref. No.	TOSTRES04
description	quartz heating element 500W 75V L 510mm ø 12mm connection male faston 6.3mm mounting distance 495mm 110hm		



1

Part No.	416871	Ref. No.	TOSTRES01
description	quartz heating element 800W 230V L 285mm		



hot plates

round

with radiused edge

for domestic and commercial kitchens



1

Part No.	490129	Ref. No.	SNACKPIAS1
description	hot plate ø 180mm 1500W 230V connection 4 screw clamps with 8mm spill ring		



1

Part No.	490130	Ref. No.	SNACKPIAS2
description	hot plate ø 220mm 2000W 230V connection 4 screw clamps with 8mm spill ring		

thermostats

bi-metal thermostats

bi-metal thermostats



1

Part No.	390323	Ref. No.	VETRTERMSICU
description	bi-metal thermostat hole distancemm switch-off temp. 145°C 1NC 1-pole 16A connection F6.3 M4		

control and safety thermostats

EGO

control thermostats

55.10/19_ series



1

Part No.	375777	Ref. No.	3064
description	thermostat t.max. 180°C temperature range 70-180°C 1-pole 1NO 16A probe ø 6mm probe L 87mm capillary pipe 600mm capillary pipe isolated 350mm gland nut shaft ø 6x4.6mm shaft L 23mm shaft position upper rotation 270°		



1

Part No.	375002	Ref. No.	GRILLTERMOS
description	thermostat t.max. 320°C temperature range 55-320°C 1-pole 1NO 16A probe ø 3.1mm probe L 226mm capillary pipe 870mm capillary pipe isolated 850mm gland nut shaft L 23mm shaft position upper rotation 270°		

safety thermostats

55.32_ series



1

Part No.	375724	Ref. No.	03299/A
description	safety thermostat switch-off temp. 246°C 3-pole 20A probe ø 6mm probe L 79mm capillary pipe 1300mm capillary pipe isolated 1100mm gland nut probe SS		

IMIT / TEMPOMATIC / ARTERMO

control thermostats



1

Part No.	375620	Ref. No.	VETRTER120
description	thermostat t.max. 120°C temperature range 30-120°C 1-pole 1CO 15A probe ø 6.5mm probe L 95mm capillary pipe 1000mm capillary pipe isolated 1000mm gland nut shaft ø 6x4.6mm shaft L 19mm shaft position upper rotation 270°		

1

Part No.	375543	Ref. No.	3064
description	thermostat t.max. 190°C 1-pole gland nut shaft ø 6x4.6mm		

safety thermostats



1

Part No.	375542	Ref. No.	9004
description	safety thermostat LS1 8174 switch-off temp. 238°C 1-pole 15A probe ø 5mm probe L 100mm capillary pipe 550mm capillary pipe isolatedmm gland nut probe SS		

Part No.	375509	Ref. No.	9004
description	thermostat switch-off temp. 230°C 1-pole 1NC 16A probe ø 6mm probe L 62mm capillary pipe 450mm capillary pipe isolated 40mm gland nut probe screw connection M10x1 connection male faston 6.3mm		

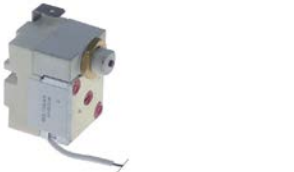

1

Part No.	375509	Ref. No.	9004
description	thermostat switch-off temp. 230°C 1-pole 1NC 16A probe ø 6mm probe L 62mm capillary pipe 450mm capillary pipe isolated 40mm gland nut probe screw connection M10x1 connection male faston 6.3mm		

CAMPINI safety thermostats



1

Part No.	375915	Ref. No.	9004
description	safety thermostat switch-off temp. 232°C 1-pole 1NC 16A probe ø 5mm probe L 68mm capillary pipe 960mm capillary pipe isolated 70mm screw connection M10		

Part No.	375915	Ref. No.	9004
description	safety thermostat switch-off temp. 232°C 1-pole 1NC 16A probe ø 5mm probe L 68mm capillary pipe 960mm capillary pipe isolated 70mm screw connection M10		

various

control thermostats



1

Part No.	375820	Ref. No.	3064
description	thermostat t.max. 190°C temperature range 0-190°C 1-pole 1CO 16A probe ø 4.5mm probe L 130mm capillary pipe 550mm shaft ø 6x4.6mm shaft L 19mm shaft position upper rotation 270° 250V		

Part No.	375820	Ref. No.	3064
description	thermostat t.max. 190°C temperature range 0-190°C 1-pole 1CO 16A probe ø 4.5mm probe L 130mm capillary pipe 550mm shaft ø 6x4.6mm shaft L 19mm shaft position upper rotation 270° 250V		

switches and momentary switches

rocker/momentary rocker switches

30x22mm



1

Part No.	301003	Ref. No.	TOSTINTER
description	rocker switch mounting measurements 30x22mm green 2NO 250V 16A illuminated 0-I connection male faston 6.3mm ambient temperature max. 125/55°C protection IP65		

Part No.	301003	Ref. No.	TOSTINTER
description	rocker switch mounting measurements 30x22mm green 2NO 250V 16A illuminated 0-I connection male faston 6.3mm ambient temperature max. 125/55°C protection IP65		

accessories for 301003



Part No.	301036	Ref. No.	—
description	protective cover internal size 30x22mm for rocker switch mounting measurementsmm		

microswitches

lever actuated



1

Part No.	345255	Ref. No.	03041/A
description	microswitch with lever 250V 16A 1CO connection male faston 6.3mm L 35mm L1 28mm ambient temperature max. 125°C mounting distance 22mm actuating force: 136g lever length 27mm		

Part No.	345255	Ref. No.	03041/A
description	microswitch with lever 250V 16A 1CO connection male faston 6.3mm L 35mm L1 28mm ambient temperature max. 125°C mounting distance 22mm actuating force: 136g lever length 27mm		



1

Part No.	347684	Ref. No.	03041/B
description	microswitch with lever 250V 16A 2NO connection male faston 6.3mm L 36mm ambient temperature max. 125°C mounting distance 22.2mm type VRSR01AA1 actuating force: 145g		

Part No.	347684	Ref. No.	03041/B
description	microswitch with lever 250V 16A 2NO connection male faston 6.3mm L 36mm ambient temperature max. 125°C mounting distance 22.2mm type VRSR01AA1 actuating force: 145g		



cam switches

on/off

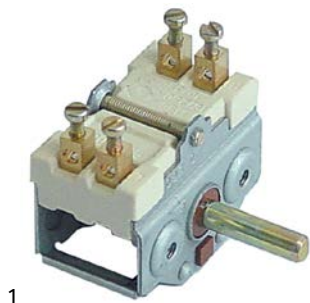

1

Part No.	300151	Ref. No.	03227/B
description	cam switch 2 operating positions 2NO sequence 0-1 16A shaft \varnothing 6x4.6mm shaft L 23mm connection screw ceramic		



1

Part No.	300176	Ref. No.	03227/A
description	cam switch 2 operating positions 4NO sequence 0-1 16A shaft \varnothing 6x4.6mm shaft L 23mm connection screw		

7-position

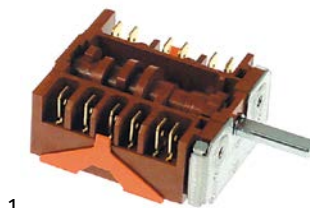

1

Part No.	300177	Ref. No.	SNACKCOMMUT
description	cam switch 7 operating positions 6NO sequence 0-1-2-3-4-5-6 16A shaft \varnothing 6x4.6mm shaft L 23mm connection male faston 6.3mm 7-position		

lamps

indicator lights

indicator light lenses

 \varnothing 10mm (type SR-3)

1

Part No.	359815	Ref. No.	3066
description	indicator light housings mounting measurements \varnothing 10mm clear Qty 1 pcs		



1

Part No.	359816	Ref. No.	3067
description	indicator light housings mounting measurements \varnothing 10mm green Qty 1 pcs		

indicator lamps for socket type SA / SC / SD / SF / SR



1

Part No.	359814	Ref. No.	3676
description	indicator lamp 230V clear connection cable 400mm cable material silicone Qty 1 pcs		

indicator lights (complete)

 \varnothing 10mm

with plug-in socket



1

Part No.	359374	Ref. No.	TOSTGEMMA
description	indicator light \varnothing 10mm 230V green		

 \varnothing 13mm

with plug-in socket



1

Part No.	359142	Ref. No.	GRILLAMPAD
description	indicator light \varnothing 13mm green 230V connection male faston 6.3mm temp.-resist. 120°C Qty 1 pcs		





1

Part No.	359143	Ref. No.	GRILLAMPAD GRILLGEMMA TOSTLAMP VETRIGEMMA
description	indicator light \varnothing 13mm yellow 230V connection male faston 6.3mm temp.-resist. 120°C Qty 1 pcs		



timers

mechanical timers

 <p>1</p>			
Part No.	350032	Ref. No.	Tosttimer
description	timer M2 2-pole operation time 15min impulse mechanical 2NO at 250V 16A permanent position no shaft ø 6x4.6mm shaft 6x4.6mm shaft L 18mm mounting distance 28mm connection rear		
accessories for	350032		
	Part No.	110366	Ref. No. Tosttimerman
	knob switch zero mark t.max.°C ø 44mm shaft ø 6x4.6mm shaft flat upper black		
	Part No.	110371	Ref. No. —
	dial plate graduation 15min permanent position no rotation 30-330° ø 60mm timers knob ø 45mm		

spare parts and accessories

knobs

 <p>1</p>			
Part No.	110366	Ref. No.	Tosttimerman
description	knob switch zero mark t.max.°C ø 44mm shaft ø 6x4.6mm shaft flat upper black		

contactors

GENERAL ELECTRIC (AEG)

power contactors

 <p>1</p>			
Part No.	380238	Ref. No.	9023 SALAMANDCONT
description	power contactor resistive load 20A 230VAC (AC3/400V) 8.4A/4kW main contacts 3NO auxiliary contacts 1NO connection screw connection type LS0510A type AEG LS0510A type GE MC1A 310A		

ignition parts

pilot burners

SIT

100 series

 <p>1</p>			
Part No.	107139	Ref. No.	03139
description	pilot burner SIT type 100 series 1 flame nozzle ø 0.2mm gas connectionmm		
spare parts for	107139		
	Part No.	100854	Ref. No. —
	pilot burner bracket double		
	Part No.	100885	Ref. No. —
	air mixing sleeve for pilot burner Qty 1 pcs		
	Part No.	107160	Ref. No. —
	pilot burner cap SIT 1 flame Hmm Lmm Qty 1 pcs		
accessories for	107139		
	Part No.	100904	Ref. No. —
	locking screw M10x1 for pipe ø 4mm Qty 1 pcs		
	Part No.	100905	Ref. No. —
	locking screw M10x1 for pipe ø 6mm Qty 1 pcs		
	Part No.	100998	Ref. No. —
	pilot burner bottom part nozzle ø 0.21mm suitable for 100 series		
	Part No.	102110	Ref. No. —
	pilot tube copper pipe ø 4mm thickness 1mm L 3000mm		
	Part No.	102111	Ref. No. —
	pilot tube copper pipe ø 6mm thickness 1mm L 3000mm		



accessories

ignition electrodes

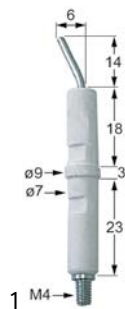

Part No.	100706	Ref. No.	3152
-----------------	--------	-----------------	------

description ignition electrode connection M4 Qty 1 pcs

electrodes

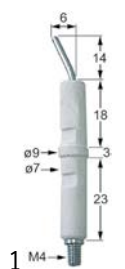

Part No.	100706	Ref. No.	3152
-----------------	--------	-----------------	------

description ignition electrode connection M4 Qty 1 pcs

gas nozzles

main nozzles

gas nozzles M12x1



Part No.	106568	Ref. No.	FRIGUGELLI
-----------------	--------	-----------------	------------

description gas injector thread M12x1 WS 13 bore ø 1.25mm

equipment-specific units

for toasters

pliers

pliers



Part No.	690010	Ref. No.	TOSTPINZA
-----------------	--------	-----------------	-----------

description plier for toaster H 180mm total length 100mm

knobs

producer-specific knobs

FORVED



Part No.	112011	Ref. No.	3096
-----------------	--------	-----------------	------

description knob switch zero mark ø 41mm shaft ø 6x4.6mm shaft flat upper black



Part No.	111550	Ref. No.	SNACKMANCUC VETREMANTERM
-----------------	--------	-----------------	-----------------------------

description knob switch zero mark ø 48mm shaft ø 6x4.6mm shaft flat upper black

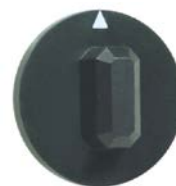

Part No.	110366	Ref. No.	Tosttimerman
-----------------	--------	-----------------	--------------

description knob switch zero mark t.max.°C°C ø 44mm shaft ø 6x4.6mm shaft flat upper black



handles and hand wheels

handle bars

handle bars



1

Part No.	693200	Ref. No.	GRILLIMPEGNO
description	handle rod		

bracket handles



1

Part No.	693440	Ref. No.	3063
description	pull handle mounting distance 88mm for fryer		
For models:	FLT 8+8BS, FLT 8BS, FLT12+12B, FLT12+12BS, FLT12B, FLT12BS, FLT20+20B, FLT20+20BS, FLT20B, FLT20BS		

hinges

oven hinges

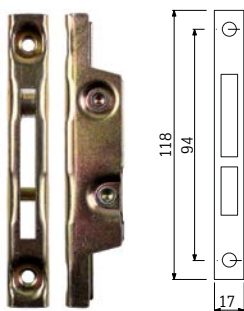



1

Part No.	700001	Ref. No.	03808c
description	opposite support L 118mm W 17mm mounting distance 94mm		



1

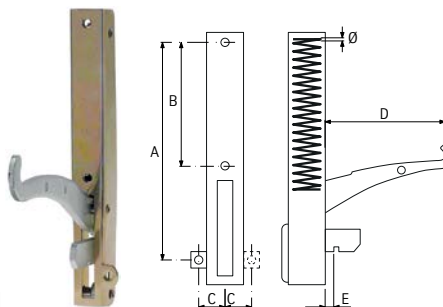

Part No.	700006	Ref. No.	03478D
description	oven hinge mounting distance 173mm mounting distance 2 105mm lug mounting 14mm lever length 120mm groove distance 11mm spring thickness 3.5mm mounting ear position left spring length 112mm W 25mm		
accessories for	700006		
	Part No.	700001	Ref. No.
			03808c
	opposite support L 118mm W 17mm mounting distance 94mm		

accessories for	700006		
	Part No.	700007	Ref. No.
			03478s
	oven hinge mounting distance 173mm mounting distance 2 105mm lug mounting 14mm lever length 120mm groove distance 11mm spring thickness 3.5mm mounting ear position right spring length 112mm W 25mm		



1

Part No.	700007	Ref. No.	03478s
description	oven hinge mounting distance 173mm mounting distance 2 105mm lug mounting 14mm lever length 120mm groove distance 11mm spring thickness 3.5mm mounting ear position right spring length 112mm W 25mm		

accessories for	700007		
	Part No.	700001	Ref. No.
			03808c
	opposite support L 118mm W 17mm mounting distance 94mm		
	Part No.	700006	Ref. No.
			03478D
	oven hinge mounting distance 173mm mounting distance 2 105mm lug mounting 14mm lever length 120mm groove distance 11mm spring thickness 3.5mm mounting ear position left spring length 112mm W 25mm		

fittings for catering equipment

outlet taps

universal

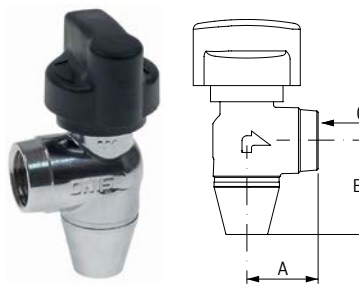

1

Part No.	540747	Ref. No.	FRIGRUBINFR8
description	outlet tap chrome-plated brass angled W 30mm H 40mm thread 1/2" IT		



producer-specific

FORVED



1			
Part No.	514006	Ref. No.	3962
description	drain pipe L 200mm thread ø 22mm		



1			
Part No.	540952	Ref. No.	3964
description	outlet tap L 84mm fryer lever handle grommet ø 30mm grommet length 29mm thread 3/4" IT handle length 81mm		

baskets

fryer baskets

FORVED



1			
Part No.	970372	Ref. No.	3960
description	fryer basket W1 190mm L1 245mm H1 110mm L2 450mm H2 225mm		



1			
Part No.	970373	Ref. No.	3967
description	fryer basket W1 210mm L1 250mm H1 110mm		



1			
Part No.	970701	Ref. No.	3961
description	fryer basket W1 220mm L1 280mm H1 110mm H2 200mm		



1			
Part No.	970374	Ref. No.	3961
description	fryer basket W1 235mm L1 270mm H1 110mm H2 210mm chrome-plated steel		



1			
Part No.	970004	Ref. No.	100117
description	fryer basket W1 313mm L1 490mm H1 115mm		



1			
Part No.	970376	Ref. No.	3323
description	fryer basket W1 337mm L1 606mm H1 115mm		

springs

torsion springs



1			
Part No.	693199	Ref. No.	GRILLMOLLA
description	torsion spring ø 21mm L1 38mm L2 118mm L3 38mm wire gauge ø 3.8mm		



valves and tank inlets

ball valves

universal

ball valves with lever handle



1

Part No.	540910	Ref. No.	3118
description	ball valve connection 3/4" IT - hose ø19mm total length 110mm with lever handle handle length 95mm		

GASTROPARTS.COM

