



GASTROPARTS

Foem

- [EN]** Equipment
- [DE]** Geräte
- [ES]** Aparatos
- [FR]** Équipement
- [IT]** Attrezzature
- [PL]** Urządzenia
- [RU]** Оборудование

✉ gastroparts@gastroparts.com

☎ +48 56 657 00 66

📘 fb.com/gastroparts.global

GASTROPARTS.COM





hot plates

square & rectangular

tiltable



1

Part No.	490085	Ref. No.	05010080750
description	hot plate dimensions 300x300mm 2500W 230V with cast edge tilt boiling plate connection 3 screw clamps H 43mm square		

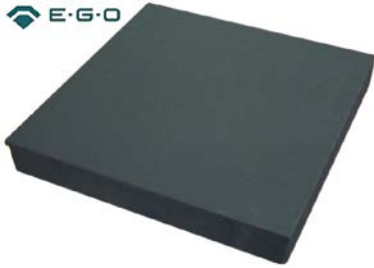

1

Part No.	490089	Ref. No.	05010080850
description	hot plate dimensions 300x300mm 4000W 230V with cast edge tilt boiling plate connection 4 screw clamps H 43mm square		

thermostats

control and safety thermostats

EGO

control thermostats

51._ series



1

Part No.	390070	Ref. No.	390070
description	thermostat t.max. 265°C temperature range 55-265°C 1-pole 1NO 15A probe ø 3mm probe L 219mm capillary pipe 2000mm gland nut shaft ø 6x4.6mm shaft L 23mm shaft position upper rotation 270° probe material SS		

55.10/19_ series



1

Part No.	375004	Ref. No.	05000087150
description	thermostat t.max. 211°C temperature range 35-200°C 1-pole 1CO 16A probe ø 6mm probe L 74mm capillary pipe 1500mm capillary pipe isolatedmm gland nut shaft L 23mm shaft position upper rotation 270° probe material SS		

55.13_ series



1

Part No.	375505	Ref. No.	03051500140
description	thermostat t.max. 320°C temperature range 50-320°C 1-pole 1NO 16A probe ø 3mm probe L 160mm capillary pipe 870mm capillary pipe isolatedmm gland nut shaft ø 6x4.6mm shaft L 23mm shaft position upper rotation 270°		

55.34_ series



1

Part No.	375410	Ref. No.	05050033650
description	thermostat t.max. 180°C temperature range 95-180°C 3-pole 3NO 16A probe ø 6mm probe L 133mm capillary pipe 1780mm capillary pipe isolated 1400mm gland nut M10x1 shaft ø 6x4.6mm shaft L 23mm shaft position upper rotation 270°		



E-G-O



Part No.	375412	Ref. No.	05000087350
description	thermostat t.max. 320°C temperature range 50-320°C 3-pole 3NO 16A probe ø 3.1mm probe L 226mm capillary pipe 1480mm capillary pipe isolated 1400mm gland nut shaft ø 6x4.6mm shaft L 23mm shaft position upper rotation 318°		

E-G-O





Part No.	375411	Ref. No.	05000087250
description	thermostat t.max. 93°C temperature range 30-93°C 3-pole 3NO 16A probe ø 6mm probe L 129mm capillary pipe 1480mm capillary pipe isolated 1100mm gland nut M10x1 shaft ø 6x4.6mm shaft L 23mm shaft position upper rotation 270°		

safety thermostats

55.10/19_series

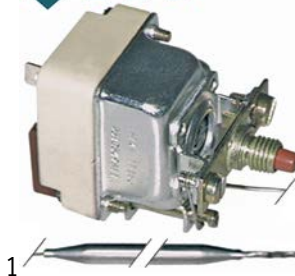
E-G-O



Part No.	390060	Ref. No.	05750107250
description	safety thermostat switch-off temp. 230°C 1-pole 0.5A probe SS probe ø 6mm probe L 77mm capillary pipe 870mm capillary pipe isolatedmm gland nut		
accessories for	390060		
	Part No.	551083	Ref. No. —
	cap for safety thermostat thread M8x1		

switches and momentary switches

cam switches

4-position

E-G-O





Part No.	300103	Ref. No.	05010049940 05010078050
description	cam switch 4 operating positions 1NO/2CO sequence 0-1-2-3 32A shaft ø 6x4.6mm shaft L 23mm connection screw ceramic		

7-position

E-G-O



Part No.	300025	Ref. No.	05000083150
description	cam switch 7 operating positions 1NO/2CO sequence 0-1-2-3-4-5-6 16A shaft ø 6x4.6mm shaft L 23mm connection screw 7-position ceramic		
accessories for	300025		
	Part No.	112172	Ref. No. —
	knob universal ø 70mm black without adaptor/dial plate		
	Part No.	112213	Ref. No. —
	knob dial plate silver switch 7-position t.max. °C ED ø 63mm ID ø 45.5mm		
	Part No.	112311	Ref. No. —
	knob adapter shaft ø 6x4.6mm L 0mm with spring		

E-G-O



Part No.	300106	Ref. No.	05010076150
description	cam switch 7 operating positions 1NO/2CO sequence 0-1-2-3-4-5-6 32A shaft ø 6x4.6mm shaft L 23mm connection screw 7-position shaft flat upper		



timers

mechanical timers

			
1			
Part No.	350049	Ref. No.	305000080050
description	timer M2 with bell 2-pole operation time 30min impulse mechanical 2NO at 250V 16A permanent position yes shaft \varnothing 6x4.6mm shaft 6x4.6mm shaft L 23mm mounting distance 28mm connection lateral		
accessories for	350049		
	Part No.	110366	Ref. No. —
	knob switch zero mark t.max.°C \varnothing 44mm shaft \varnothing 6x4.6mm shaft flat upper black		
	Part No.	111205	Ref. No. —
	dial plate graduation 30min permanent position yes rotation 30-300° \varnothing 60mm		

spare parts and accessories



knobs





			
1			
Part No.	110365	Ref. No.	30500004050
description	knob switch zero mark t.max.°C \varnothing 44mm shaft \varnothing 3.5x3.5mm shaft flat black		

gas taps

PEL

20S series

			
1			
Part No.	101068	Ref. No.	05010014700
description	gas tap PEL type 20S gas inlet M16x1.5 (tube \varnothing 10mm) bypass nozzle \varnothing 0.2mm gas outlet 1/4" (tube \varnothing 6mm) thermocouple connection M8x1 pilot connection shaft \varnothing 8x6.5mm shaft L 22/15mm shaft flat upper conversion kit tube \varnothing 10mm		
spare parts for	101068		
	Part No.	101060	Ref. No. —
	magnet unit standard L 39mm D1 \varnothing 15.4mm D2 \varnothing 11mm suitable for PEL20-21/JUNKERS/EGA		
	Part No.	101205	Ref. No. —
	gas tap front part shaft \varnothing 8x6.5mm shaft L 22/15mm shaft flat upper/lower suitable for PEL20		

spare parts for	101068		
	Part No.	101230	Ref. No. —
	thermocouple nut T1: M8x1 T2: M18x1 aluminium		
	Part No.	101278	Ref. No. —
	olive for pipe \varnothing 10mm Qty 1 pcs		
	Part No.	101300	Ref. No. —
	union nut thread M16x1.5 tube \varnothing 10mm		
accessories for	101068		
	Part No.	110081	Ref. No. —
	knob \varnothing 70mm shaft \varnothing 8x6.5mm shaft flat universal		
	Part No.	110083	Ref. No. —
	knob dial plate gas tap without ignition flame silver		

22S/V series















			
1			
Part No.	101087	Ref. No.	05000070930
description	gas tap PEL type 22S/V gas inlet M20x1.5 (tube \varnothing 12mm) bypass nozzle \varnothing 0.35mm gas outlet M20x1.5 (tube \varnothing 12/10mm) thermocouple connection M9x1 pilot connection M10x1 shaft \varnothing 10x8mm shaft L 25/17mm shaft flat upper		
spare parts for	101087		
	Part No.	100259	Ref. No. —
	bypass nozzle type PEL22 bore \varnothing 0.35mm thread M6x0.5		
	Part No.	101058	Ref. No. —
	magnet unit L 39mm D1 \varnothing 15.4mm D2 \varnothing 13.5mm suitable for PEL22/EGA24197 standard		
	Part No.	101201	Ref. No. —
	gas tap front part shaft \varnothing 10x8mm shaft L 25/17mm shaft flat upper/lower suitable for PEL22		
	Part No.	101231	Ref. No. —
	thermocouple nut T1: M9x1 T2: M18x1		
	Part No.	101241	Ref. No. —
	gas connection thread M20x1.5 tube \varnothing 12/10mm for PEL gas taps vertical		
	Part No.	101460	Ref. No. —
	O-ring \varnothing 12.37mm D1 \varnothing 2.62mm suitable for PEL22		
	Part No.	101461	Ref. No. —
	screw kit suitable for PEL22 Qty 4 pcs		
accessories for	101087		
	Part No.	100908	Ref. No. —
	union screw thread M10x1 for pipe \varnothing 4mm Qty 1 pcs		
	Part No.	100909	Ref. No. —
	union screw thread M10x1 for pipe \varnothing 6mm Qty 1 pcs		

Table continues overleaf









accessories for		101087		
Part No.		Ref. No.		
	gas connection thread M20x1.5 tube ø 12/10mm for PEL gas taps with gasket and screws horizontal	101240	Ref. No.	—
	olive for pipe ø 4mm Qty 1 pcs	101246	Ref. No.	—
	olive for pipe ø 12mm Qty 1 pcs suitable for PEL	101248	Ref. No.	—
	olive for pipe ø 10mm Qty 1 pcs	101249	Ref. No.	—
	union nut thread M20x1.5 for pipe ø 10mm	101250	Ref. No.	—
	union nut thread M20x1.5 for pipe ø 12mm	101251	Ref. No.	—
	olive ID ø 6mm Qty 1 pcs	101286	Ref. No.	—
	knob ø 70mm shaft ø 10x8mm shaft flat universal	110080	Ref. No.	—
	knob dial plate silver gas tap PEL21/22/23 t.max.°C ED ø 63mm ID ø 45.5mm	112206	Ref. No.	—

23S/O series



1



Part No.	101092	Ref. No.	05030043730	
description	gas tap PEL type 23S/O gas inlet M28x1.5 (tube ø 20mm) bypass nozzle ø 0.35mm gas outlet M24x1.5 (tube ø 16mm) thermocouple connection M10x1 pilot connection M10x1 shaft ø 10x8mm shaft L 25/17mm shaft flat upper			
spare parts for	101092			
	Part No.	100455	Ref. No.	—
	bypass nozzle type PEL23/24 bore ø 0.35mm thread M8x0.5			
	Part No.	101059	Ref. No.	—
	magnet unit T1: M10x1 T2: M22x1 L 46mm ø 18mm suitable for PEL23S M10x1			
	Part No.	101204	Ref. No.	—
	gas tap front part shaft ø 10x8mm shaft L 25/17mm shaft flat upper/lower suitable for PEL23S			
	Part No.	101244	Ref. No.	—
	gas connection thread M24x1.5 tube ø 12/16mm horizontal for PEL gas taps			
	Part No.	101463	Ref. No.	—
	screw suitable for PEL23S Qty 4 pcs			
	Part No.	528455	Ref. No.	—
	O-ring Viton thickness 2.62mm ID ø 18.72mm Qty 1 pcs			

accessories for		101092		
Part No.		Ref. No.		
	union screw thread M10x1 for pipe ø 4mm Qty 1 pcs	100908	Ref. No.	—
	union screw thread M10x1 for pipe ø 6mm Qty 1 pcs	100909	Ref. No.	—
	olive for pipe ø 4mm Qty 1 pcs	101246	Ref. No.	—
	union nut thread M24x1.5 for pipe ø 12mm	101252	Ref. No.	—
	union nut thread M24x1.5 PEL for pipe ø 16mm	101253	Ref. No.	—
	union nut thread M28x1.5 tube ø 20mm	101254	Ref. No.	—
	olive for pipe ø 12mm Qty 1 pcs	101255	Ref. No.	—
	olive for pipe ø 16mm Qty 1 pcs	101256	Ref. No.	—
	olive for pipe ø 20mm Qty 1 pcs	101257	Ref. No.	—
	olive ID ø 6mm Qty 1 pcs	101286	Ref. No.	—
	knob ø 70mm shaft ø 10x8mm shaft flat universal	110080	Ref. No.	—
	knob dial plate silver gas tap PEL21/22/23 t.max.°C ED ø 63mm ID ø 45.5mm	112206	Ref. No.	—

JUNKERS











1

Part No.	nla ¹	Ref. No.	05000029000	
description	gas tap JUNKERS type CH110 gas inlet M20x1.5 bypass nozzle ø 0.35mm gas outlet M20x1.5 thermocouple connection M8x1 pilot connection M10x1 shaft ø 10mm shaft L 20.7mm shaft flat pipe outlet ø 12/10mm			
spare parts for	101096			
	Part No.	101060	Ref. No.	—
	magnet unit standard L 39mm D1 ø 15.4mm D2 ø 11mm suitable for PEL20-21/JUNKERS/EGA			
	Part No.	101230	Ref. No.	—
	thermocouple nut T1: M8x1 T2: M18x1 aluminium			

¹no longer available
Table continues overleaf



accessories for		101096		
Part No.	Ref. No.	Ref. No.	Ref. No.	Ref. No.
	100945	—	—	—
roll pin ø 3.2mm L 10mm				
	101219	—	—	—
shaft extension L 25mm JUNKERS				
	101233	—	—	—
union nut thread M10x1 JUNKERS				
	101281	—	—	—
olive for pipe ø 4mm L 8.7mm Qty 1 pcs suitable for CB 502/503				
	101284	—	—	—
olive for pipe ø 4mm Qty 1 pcs				
	101285	—	—	—
union screw thread M8x1 for pipe ø 4mm Qty 1 pcs JUNKERS				
	110064	—	—	—
knob				
	110066	—	—	—
knob screw				
	550396	—	—	—
shaft extension L 25mm JUNKERS				



accessories for		101132		
Part No.	Ref. No.	Ref. No.	Ref. No.	Ref. No.
	100904	—	—	—
locking screw M10x1 for pipe ø 4mm Qty 1 pcs				
	100905	—	—	—
locking screw M10x1 for pipe ø 6mm Qty 1 pcs				
	101054	—	—	—
magnet unit T1: M10x1 T2: M24x1 L 45mm ø 17mm suitable for Minisit				
	101136	—	—	—
piezoelectric igniter suitable for Minisit with cover cap ømm connection F6.3x0.8				
	101137	05010014700	—	—
cover cap without piezoelectric igniter				
	101267	—	—	—
reducer IT 3/8" ET 1/2" L 21mm				
	101268	—	—	—
gas connection thread 3/8" angled with O-ring MINISIT 710				
	101269	—	—	—
gas connection thread 1/2" angled with O-ring MINISIT 710				
	101270	—	—	—
screw connection IT 3/8" ET 3/8" L 28mm				
	101272	—	—	—
screw connection IT 1/2" ET 3/8" L 57mm				
	101273	—	—	—
olive for pipe ø 12mm L 9.5mm brass Qty 1 pcs suitable for universal				
	101274	—	—	—
olive for pipe ø 16mm Qty 1 pcs				
	101275	—	—	—
union screw thread 1/2" for pipe ø 16mm Qty 1 pcs				
	101276	—	—	—
union screw thread 3/8" tube ø 12mm Qty 1 pcs				
	110068	—	—	—
knob suitable for Minisit ø 37mm				

gas thermostats

SIT

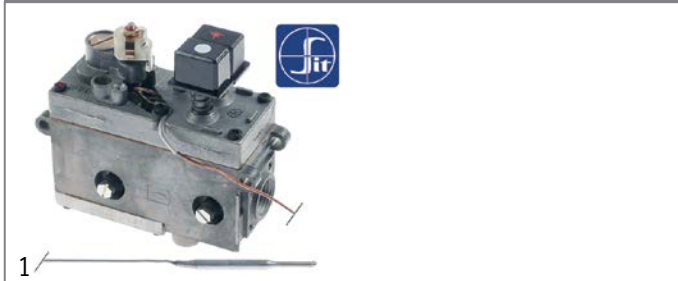
710 Minisit series



Part No.	Ref. No.	Ref. No.	Ref. No.	Ref. No.
101132	05010014700	—	—	—
description gas thermostat SIT type MINISIT 710 t.max. 340°C 100-340°C gas inlet 1/2" gas outlet 3/8" thermocouple connection M9x1 pilot connection M10x1 probe ø 5mm probe L 68mm capillary pipe 1050mm probe type type B1 pressure controller no pressure regulator mbar gland nut ignition gas no				
spare parts for		101132		
	101053	—	—	—
magnet unit T1: M9x1 T2: M24x1 L 45mm ø 17mm suitable for Minisit				
	102102	—	—	—
probe 100-340°C probe ø 5mm probe L 68mm capillary pipe 1750mm t.max. 340°C oven/grill probe type type B1 suitable for MINISIT 710				
accessories for		101132		
	100809	—	—	—
O-ring EPDM thickness 2mm ID ø 21mm Qty 1 pcs				



gas valves and ignition boxes









gas control valves

SIT

ELETTROSIT



1

Part No.	101126	Ref. No.	305150036150
description	gas valve SIT type ELETTROSIT 230V gas inlet 1/2" gas outlet 1/2" thermocouple connection M9x1 pilot connection M10x1 bottom equiv. no. 0.810.136		
spare parts for	101126		
	Part No.	101312	Ref. No. —
	microswitch		
	Part No.	101352	Ref. No. —
	solenoid coil 230V 50Hz suitable for ELETTROSIT		
accessories for	101126		
	Part No.	100006	Ref. No. —
	piezoelectric igniter suitable for ELETTROSIT body plastic blowing connection ø2.4mm ø 14mm		
	Part No.	100904	Ref. No. —
	locking screw M10x1 for pipe ø 4mm Qty 1 pcs		
	Part No.	100905	Ref. No. —
	locking screw M10x1 for pipe ø 6mm Qty 1 pcs		
	Part No.	101301	Ref. No. —
	gas connection thread 1/2" straight ELETTROSIT screw with O-ring		
	Part No.	101303	Ref. No. —
	gas connection straight thread 3/4" ELETTROSIT		
	Part No.	101309	Ref. No. —
	extension		

ignition parts









pilot burners

SIT

100 series



1

Part No.	106901	Ref. No.	05019906800
description	pilot burner SIT type 100 series 1 flame nozzle ø 0.2mm gas connection 6mm		
spare parts for	106901		
	Part No.	100854	Ref. No. —
	pilot burner bracket double		
	Part No.	100916	Ref. No. —
	compression spring for pilot burner Qty 1 pcs		
	Part No.	100917	Ref. No. —
	gasket for pilot burner Qty 1 pcs aluminium		
	Part No.	100918	Ref. No. —
	screw for pilot burner		
accessories for	106901		
	Part No.	100904	Ref. No. —
	locking screw M10x1 for pipe ø 4mm Qty 1 pcs		
	Part No.	100905	Ref. No. —
	locking screw M10x1 for pipe ø 6mm Qty 1 pcs		
	Part No.	102110	Ref. No. —
	pilot tube copper pipe ø 4mm thickness 1mm L 3000mm		
	Part No.	102111	Ref. No. —
	pilot tube copper pipe ø 6mm thickness 1mm L 3000mm		
	Part No.	102742	Ref. No. —
	pilot burner nozzle LPG code 25 bore ø 0.25mm Qty 1 pcs		



1

















Part No.	106906	Ref. No.	05000010100 05000027300
description	pilot burner SIT type 100 series 3 flames nozzle ø 0.2mm gas connection 6mm		
spare parts for	106906		
	Part No.	100245	Ref. No. —
	pilot burner nozzle LPG code 20 bore ø 0.2mm Qty 1 pcs thread M8x0.75		

Table continues overleaf



spare parts for 106906	
	Part No. 100855 Ref. No. — pilot burner bracket triple
	Part No. 100885 Ref. No. — air mixing sleeve for pilot burner Qty 1 pcs
	Part No. 100916 Ref. No. — compression spring for pilot burner Qty 1 pcs
	Part No. 100917 Ref. No. — gasket for pilot burner Qty 1 pcs aluminium
	Part No. 100918 Ref. No. — screw for pilot burner
	Part No. 107162 Ref. No. — pilot burner cap SIT 3 flames Hmm Lmm Qty 1 pcs
	Part No. 107701 Ref. No. — pilot burner bottom part SIT 100 series nozzle ϕ 0.2mm
accessories for 106906	
	Part No. 100245 Ref. No. — pilot burner nozzle LPG code 20 bore ϕ 0.2mm Qty 1 pcs thread M8x0.75
	Part No. 100246 Ref. No. — pilot burner nozzle natural gas bore ϕ 0.35mm Qty 1 pcs thread M8x0.75
	Part No. 100904 Ref. No. — locking screw M10x1 for pipe ϕ 4mm Qty 1 pcs
	Part No. 100905 Ref. No. — locking screw M10x1 for pipe ϕ 6mm Qty 1 pcs
	Part No. 102110 Ref. No. — pilot tube copper pipe ϕ 4mm thickness 1mm L 3000mm
	Part No. 102111 Ref. No. — pilot tube copper pipe ϕ 6mm thickness 1mm L 3000mm
	Part No. 107171 Ref. No. — pilot burner nozzle SIT natural/liquid gas bore ϕ 0.25mm Qty 1 pcs
	Part No. 107700 Ref. No. — pilot burner bottom part SIT 100 series nozzle ϕ 0.25mm
	Part No. 107702 Ref. No. — pilot burner bottom part SIT 100 series nozzle ϕ 0.35mm

accessories			
ignition electrodes			
			
Part No.	100706	Ref. No.	05000078750
description	ignition electrode connection M4 Qty 1 pcs		

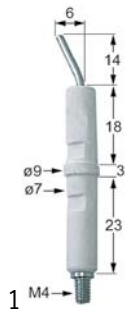













JUNKERS			
CB 503 series			
pilot burners			
			
Part No.	100101	Ref. No.	05010055800
description	pilot burner JUNKERS type CB503003 LPG nozzle no.2 gas connection 4mm with primary air		
spare parts for 100101			
	Part No. 100224	Ref. No.	—
pilot burner nozzle natural gas gas pressure 25mbar code 26 Qty 1 pcs suitable for JUNKERS CB503_			
	Part No. 101281	Ref. No.	—
olive for pipe ϕ 4mm L 8.7mm Qty 1 pcs suitable for CB 502/503			
	Part No. 101283	Ref. No.	—
union screw thread M10x1 for pipe ϕ 4mm Qty 1 pcs			
accessories for 100101			
	Part No. 100220	Ref. No.	—
pilot burner nozzle LPG gas pressure 50mbar code 2 Qty 1 pcs suitable for JUNKERS CB503_			
	Part No. 100221	Ref. No.	—
pilot burner nozzle LPG gas pressure 30mbar code 29 Qty 1 pcs suitable for JUNKERS CB50203_			
	Part No. 100222	Ref. No.	—
pilot burner nozzle LPG gas pressure 50mbar code 5 Qty 1 pcs suitable for JUNKERS CB50203_			
	Part No. 100223	Ref. No.	—
pilot burner nozzle natural gas gas pressure 20mbar code 3 Qty 1 pcs suitable for JUNKERS CB503_			
	Part No. 100226	Ref. No.	—
pilot burner nozzle LPG gas pressure 50mbar code 15 suitable for JUNKERS			
	Part No. 100227	Ref. No.	—
pilot burner nozzle natural gas gas pressure 25mbar code 6 Qty 1 pcs suitable for JUNKERS CB50203_			

Table continues overleaf



accessories for 100101	
	Part No. 100228 Ref. No. — pilot burner nozzle town gas gas pressure 8mbar code 4 Qty 1 pcs suitable for JUNKERS CB50203_
	Part No. 100909 Ref. No. — union screw thread M10x1 for pipe ø 6mm Qty 1 pcs
	Part No. 101287 Ref. No. — olive for pipe ø 6mm Qty 1 pcs
	Part No. 102110 Ref. No. — pilot tube copper pipe ø 4mm thickness 1mm L 3000mm
	Part No. 102111 Ref. No. — pilot tube copper pipe ø 6mm thickness 1mm L 3000mm

electrodes

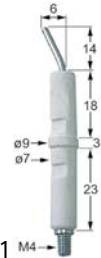
	Part No. 100706 Ref. No. 05000078750
description ignition electrode connection M4 Qty 1 pcs	

ignition cables

pre-assembled cables

	Part No. 100026 Ref. No. 05000080350
description ignition cable cable length 1000mm connection ø4mm / F6.3mm	

piezoelectric igniters

mounting diameter 18mm

	Part No. 100003 Ref. No. 05000080200
description piezoelectric igniter body metal blowing mounting ø 18mm connection F2.8x0.8	

thermocouples

plug-in thermocouples

plug-in thermocouples standard

with barrel socket ø6(6.5)mm

thermocouples SIT

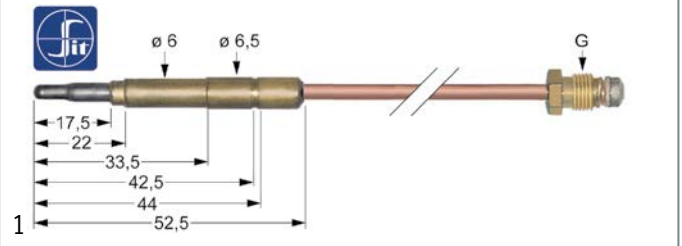

Part No. 107619 Ref. No. 05050103900
description thermocouple SIT M10x1 L 1000mm plug connection ø6.0(6.5)mm

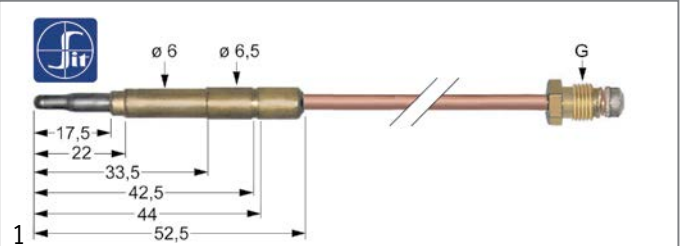

Part No. 107613 Ref. No. 05000097100
description thermocouple SIT M9x1 L 1200mm plug connection ø6.0(6.5)mm

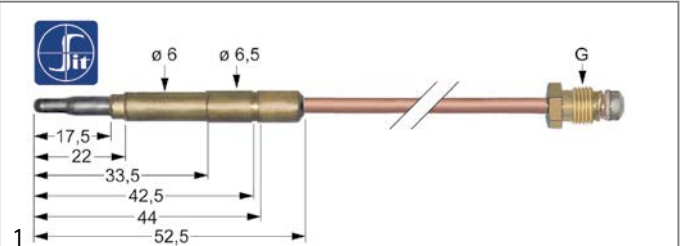

Part No. 107614 Ref. No. 05000026900
description thermocouple SIT M9x1 L 1500mm plug connection ø6.0(6.5)mm

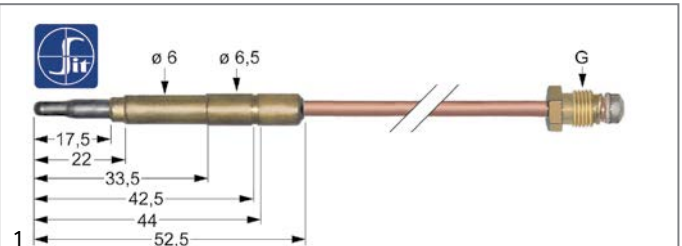

Part No. 107606 Ref. No. 05021300200
description thermocouple SIT M9x1 L 320mm plug connection ø6.0(6.5)mm



Part No.	107611	Ref. No.	05019906600
description	thermocouple SIT M9x1 L 850mm plug connection ϕ 6.0(6.5)mm		

gas burners

hob burners

producer-specific hob burners

FOEM

universal

Part No.	103046	Ref. No.	05000012530 050099108902
description	burner cap ϕ 110mm with central hole		

Part No.	103045	Ref. No.	05000012630 05019909102
description	burner cap ϕ 80mm		
accessories for	103045		
Part No.	104070	Ref. No.	—
description	burner head for burner cap ϕ 70mm		

knobs

producer-specific knobs

FOEM

Part No.	110365	Ref. No.	30500004050
description	knob switch zero mark t.max. °C ϕ 44mm shaft ϕ 3.5x3.5mm shaft flat black		

hinges

oven hinges

Part No.	700016	Ref. No.	05150024501
description	oven hinge mounting distance 118mm mounting distance 2mm lug mounting 13mm lever length 116mm groove distance 11mm spring thickness 3.5mm mounting ear position left spring length 61mm L 153mm W 20mm		
accessories for	700016		
Part No.	700003	Ref. No.	—
description	opposite support L 110mm W 12mm mounting distance 94mm		

Part No.	700015	Ref. No.	05150024401
description	oven hinge mounting distance 118mm mounting distance 2mm lug mounting 13mm lever length 116mm groove distance 11mm spring thickness 3.5mm mounting ear position right spring length 61mm L 153mm W 20mm		
accessories for	700015		
Part No.	700003	Ref. No.	—
description	opposite support L 110mm W 12mm mounting distance 94mm		

Part No.	700006	Ref. No.	0501001101
description	oven hinge mounting distance 173mm mounting distance 2 105mm lug mounting 14mm lever length 120mm groove distance 11mm spring thickness 3.5mm mounting ear position left spring length 112mm W 25mm		
accessories for	700006		
Part No.	700001	Ref. No.	—
description	opposite support L 118mm W 17mm mounting distance 94mm		



Table continues overleaf

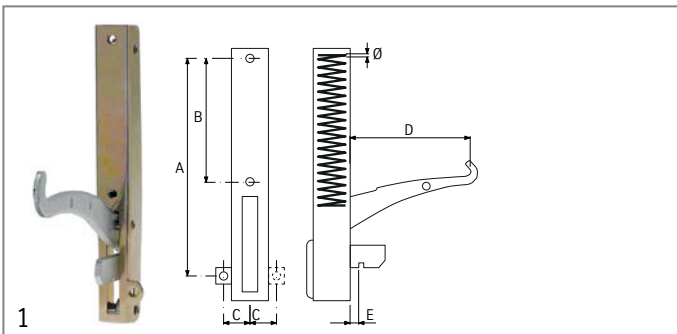

accessories for	700006		
Part No.	700007	Ref. No.	05010001201
	oven hinge mounting distance 173mm mounting distance 2 105mm lug mounting 14mm lever length 120mm groove distance 11mm spring thickness 3.5mm mounting ear position right spring length 112mm W 25mm		



Part No.	700007	Ref. No.	05010001201
description	oven hinge mounting distance 173mm mounting distance 2 105mm lug mounting 14mm lever length 120mm groove distance 11mm spring thickness 3.5mm mounting ear position right spring length 112mm W 25mm		

accessories for	700007			
	Part No.	700001	Ref. No.	—
	opposite support L 118mm W 17mm mounting distance 94mm			
	Part No.	700006	Ref. No.	0501001101
	oven hinge mounting distance 173mm mounting distance 2 105mm lug mounting 14mm lever length 120mm groove distance 11mm spring thickness 3.5mm mounting ear position left spring length 112mm W 25mm			

safety fittings

safety fittings



Part No.	540744	Ref. No.	05030033801	
description	safety fitting thread 1 1/4" 0.5bar with manometer 3kg H 269mm			
spare parts for	540744			
	Part No.	514121	Ref. No.	—
	safety valve triggering pressure 0.5bar with CE approval M88 thread 1 1/4"			
	Part No.	540821	Ref. No.	—
	fitting support thread 1 1/4"			
	Part No.	540827	Ref. No.	05030032301
	aerator and air bleeder thread 3/4" ET chrome-plated L 45mm ø 36mm			
	Part No.	540829	Ref. No.	—
	manometer siphon thread 1/2"			
	Part No.	540830	Ref. No.	05030034401
	pressure gauge tap IT 1/4" ET 1/4"			
	Part No.	541062	Ref. No.	05030033701
	manometer ø 63mm pressure range 0 up to 1bar connection marking adjustable kettle thread 1/4"			

fittings for catering equipment

aerators and air bleeders



Part No.	540827	Ref. No.	05030032301
description	aerator and air bleeder thread 3/4" ET chrome-plated L 45mm ø 36mm		

accessories



Part No.	540836	Ref. No.	05030031601
description	funnel thread 1/2" with shut-off valve		



Part No.	540830	Ref. No.	05030034401
description	pressure gauge tap IT 1/4" ET 1/4"		



safety valves



1

Part No.	540721	Ref. No.	05030032201
description	safety valve triggering pressure 0.5bar M88 thread 1¼"		
accessories for	540721		
	Part No.	541501	Ref. No. —
	reducer for safety fitting IT 1¼" ET 3/4"		

measuring equipment

thermometers

built-in thermometers

ø60mm



1

Part No.	379593	Ref. No.	05159905800
description	thermometer mounting ø 60mm t.max. 300°C 50-300°C probe ø 4mm probe L 135mm capillary pipe 1050mm		

manometers



1

Part No.	541062	Ref. No.	05030033701
description	manometer ø 63mm pressure range 0 up to 1bar connection marking adjustable kettle thread 1/4"		
spare parts for	541062		
	Part No.	541130	Ref. No. —
	glass panel ø 58mm thickness 2mm		

GASTROPARTS.COM

