



**GASTROPARTS**

# Fiorenzato-CS

- [EN]** Equipment
- [DE]** Geräte
- [ES]** Aparatos
- [FR]** Équipement
- [IT]** Attrezzature
- [PL]** Urządzenia
- [RU]** Оборудование

✉ [gastroparts@gastroparts.com](mailto:gastroparts@gastroparts.com)

☎ +48 56 657 00 66

📘 [fb.com/gastroparts.global](https://fb.com/gastroparts.global)

**GASTROPARTS.COM**











## heating elements

### heating elements for coffee machine

			
1			
<b>Part No.</b>	417354	<b>Ref. No.</b>	A2100146
<b>description</b>	heating element 2700W 230V heating circuits 3 mounting $\varnothing$ 42mm hole distance 74mm L 160mm W 34mm H 45mm L1 20mm L2 70mm L3 80mm H1 32mm H2 13mm hole $\varnothing$ 10mm tube $\varnothing$ 8.3mm thermostat sleeves $\varnothing$ 7mm length thermostat sleeves 140mm thermostat sleeve centre number of thermostat sleeves 1 connection male faston 6.3mm immersion heater 2 hole flange		

			
1			
<b>Part No.</b>	417355	<b>Ref. No.</b>	A2100213
<b>description</b>	heating element 2700W 230V heating circuits 3 thread 1 1/4" L 160mm W 30mm H 45mm tube $\varnothing$ 8mm connection male faston 6.3mm immersion heater flange with thread WS 37		
<b>accessories for</b>	417355		
	<b>Part No.</b>	528017	<b>Ref. No.</b> -
	flat gasket fibre ED $\varnothing$ 53mm ID $\varnothing$ 42mm thickness 2mm for thread 1 1/4" Qty 1 pcs		
	<b>Part No.</b>	528022	<b>Ref. No.</b> -
	flat gasket PTFE ED $\varnothing$ 52mm ID $\varnothing$ 41mm thickness 2mm size 1 1/4" Qty 1 pcs suitable for CARIMALI, FAEMA, MARZOCCO, PAVONI		

			
1			
<b>Part No.</b>	417353	<b>Ref. No.</b>	A2100031
<b>description</b>	heating element 3500W 230/400V heating circuits 3 mounting $\varnothing$ 43mm hole distance 74mm L 295mm W 34mm H 45mm L1 35mm L2 55mm L3 205mm H1 31mm H2 14mm hole $\varnothing$ 9.5mm tube $\varnothing$ 8.3mm thermostat sleeves $\varnothing$ 7mm length thermostat sleeves 210mm thermostat sleeve centre number of thermostat sleeves 1 connection male faston 6.3mm immersion heater 2 hole flange		
<b>accessories for</b>	417353		
	<b>Part No.</b>	528021	<b>Ref. No.</b> A1200015
	flat gasket PTFE ED $\varnothing$ 53mm ID $\varnothing$ 42.5mm thickness 3mm Qty 1 pcs equiv. no. 12001/02286 suitable for Astoria/Aurora/Brasilia/Wega		

			
1			
<b>Part No.</b>	417352	<b>Ref. No.</b>	A2100120
<b>description</b>	heating element 4000W 230/400V heating circuits 3 mounting $\varnothing$ 43mm hole distance 74mm L 545mm W 34mm H 45mm L1 35mm L2 55mm L3 455mm H1 31mm H2 14mm hole $\varnothing$ 9.5mm tube $\varnothing$ 8.3mm thermostat sleeves $\varnothing$ 7mm length thermostat sleeves 210mm thermostat sleeve centre number of thermostat sleeves 1 connection male faston 6.3mm immersion heater 2 hole flange		

## accessories

### sealing washers

#### PTFE gaskets

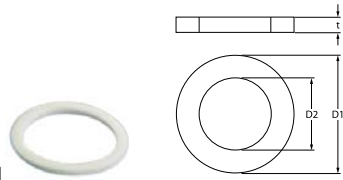
			
1			
<b>Part No.</b>	528021	<b>Ref. No.</b>	A1200015
<b>description</b>	flat gasket PTFE ED $\varnothing$ 53mm ID $\varnothing$ 42.5mm thickness 3mm Qty 1 pcs equiv. no. 12001/02286 suitable for Astoria/Aurora/Brasilia/Wega		

### O-rings

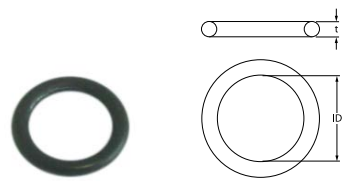
			
1			
<b>Part No.</b>	528231	<b>Ref. No.</b>	A1200028
<b>description</b>	O-ring Viton thickness 2.62mm ID $\varnothing$ 12.37mm Qty 1 pcs		

## thermostats

### bi-metal thermostats

#### bi-metal thermostats

			
1			
<b>Part No.</b>	390328	<b>Ref. No.</b>	A1400035
<b>description</b>	bi-metal thermostat hole distance mm switch-off temp. 152°C 1NC 1-pole 16A connection F6.3 M4		

## switches and momentary switches



### rocker/momentary rocker switches



#### 30x22mm

			
1			
<b>Part No.</b>	301061	<b>Ref. No.</b>	A2100093
<b>description</b>	rocker switch mounting measurements 30x22mm orange 2NO 250V 16A illuminated connection male faston 6.3mm ambient temperature max. 125/55°C protection IP40		



			
1			
<b>Part No.</b>	301036	<b>Ref. No.</b>	A2800052
<b>description</b>	protective cover internal size 30x22mm for rocker switch mounting measurementsmm		

			
1			
<b>Part No.</b>	301078	<b>Ref. No.</b>	A2100038
<b>description</b>	momentary rocker switch mounting measurements 30x22mm black 2NO 250V 16A momentary 0-I connection male faston 6.3mm ambient temperature max. 85/125°C protection IP40		
<b>accessories for</b>	301078		
	<b>Part No.</b>	301036	<b>Ref. No.</b> A2800052
	protective cover internal size 30x22mm for rocker switch mounting measurementsmm		

blank			
			
1			
<b>Part No.</b>	346144	<b>Ref. No.</b>	340226
<b>description</b>	push switch mounting measurements 30x22mm white 2CO 250V 16A illuminated connection male faston 6.3mm ambient temperature max. 100/55°C protection IP65		
<b>accessories for</b>	346144		
	<b>Part No.</b>	301036	<b>Ref. No.</b> A2800052
	protective cover internal size 30x22mm for rocker switch mounting measurementsmm		

## push/momentary push switches

19x13mm			
			
1			
<b>Part No.</b>	347292 <sup>1</sup>	<b>Ref. No.</b>	A2100043
<b>description</b>	push switch mounting measurements 19x13mm red 2NO 250V 16A illuminated connection male faston 6.3mm ambient temperature max. 105/55°C protection IP65 with cover cap		

<sup>1</sup>illuminated

30x22mm			
			
1			
<b>Part No.</b>	301036	<b>Ref. No.</b>	A2800052
<b>description</b>	protective cover internal size 30x22mm for rocker switch mounting measurementsmm		

ø25mm			
			
1			
<b>Part No.</b>	347295	<b>Ref. No.</b>	A2100041
<b>description</b>	push button mounting ø 25mm black 2NO 250V 16A connection male faston 6.3mm ambient temperature max. 85°C protection IP40		

			
1			
<b>Part No.</b>	347294 <sup>1</sup>	<b>Ref. No.</b>	A2100045
<b>description</b>	push switch mounting ø 25mm red 2NO 250V 16A illuminated connection male faston 6.3mm ambient temperature max. 125/55°C protection IP40		

<sup>1</sup>illuminated

			
1			
<b>Part No.</b>	347293	<b>Ref. No.</b>	A2100094
<b>description</b>	push switch mounting ø 25mm orange 2NO 250V 16A illuminated cup connection male faston 6.3mm ambient temperature max. 85°C protection IP40		

## microswitches

pin-plunger actuated			
			
1			
<b>Part No.</b>	346145	<b>Ref. No.</b>	210031
<b>description</b>	microswitch with plunger 250V 10A 1CO connection male faston 4.8mm ambient temperature max. 125°C mounting distance 22mm black		

			
1			
<b>Part No.</b>	347757	<b>Ref. No.</b>	A2100297
<b>description</b>	microswitch with plunger 250V 16A 1CO connection male faston 4.8mm ambient temperature max. 125°C mounting distance 22mm actuating force: 120g black		



roller actuated			
roller 90°			
			
1			
<b>Part No.</b>	345104	<b>Ref. No.</b>	A2100042
<b>description</b>	microswitch with roller plunger 250V 16A 1CO connection male faston 6.3mm L 24mm ambient temperature max. 125°C thread L 12mm thread M10x0.75 mounting distance 22mm actuating force: 280g type EF83161.1		

rotary switches			
miscellaneous			
			
1			
<b>Part No.</b>	347296	<b>Ref. No.</b>	A2100103 A2100316
<b>description</b>	rotary switch 25A shaft L 15mm with cable 6-pole shaft 5x5mm		

## control equipment

MOELLER/EATON			
LED signal elements			
			
1			
<b>Part No.</b>	346487	<b>Ref. No.</b>	A2100319
<b>description</b>	indicator lamp white connection screw LED 85-264VAC		

## lamps

indicator lights			
indicator lights (complete)			
ø 6mm			
			
1			
<b>Part No.</b>	359568	<b>Ref. No.</b>	A2100024
<b>description</b>	indicator light ø 6mm 230V red connection male faston 2.8mm cable length 250mm		

ø10mm			
with plug-in socket			
			
1			
<b>Part No.</b>	359140	<b>Ref. No.</b>	A2100046
<b>description</b>	indicator light ø 10mm yellow 230V connection male faston 6.3mm Qty 1 pcs		

## contactors

ISKRA (FANAL)			
power contactors			
			
1			
<b>Part No.</b>	380413	<b>Ref. No.</b>	21003F
<b>description</b>	power contactor resistive load 20A 400VAC (AC3/400V) 8.5A/5.5kW main contacts 3NO auxiliary contacts 1NC connection screw connection type Fanal DSL7 01 type ISKRA K07M 01		

SIEMENS			
power contactors			
			
1			
<b>Part No.</b>	380526	<b>Ref. No.</b>	A2100154
<b>description</b>	power contactor resistive load 20A 230VAC (AC3/400V) 8.4A/4kW main contacts 4NO auxiliary contacts connection screw connection type 3TG10-10-0A2L2		



## relays

## power relays

with bracket mounting



1

<b>Part No.</b>	380920	<b>Ref. No.</b>	A3200109
<b>description</b>	power relays FINDER 400VAC 10A 3CO connection male faston 4.8mm with mounting strap manuf. no. 60.63.8.400.0000 250V 3-pole		

## level relays

GICAR



1

<b>Part No.</b>	400524	<b>Ref. No.</b>	A1500005
<b>description</b>	level relay 230V voltage AC connection F6.3 type RL30 MICRO ST SAFETY PUMP		

DTI



1

<b>Part No.</b>	402445	<b>Ref. No.</b>	A1500082
<b>description</b>	level controller 230V voltage AC 50/60Hz 8A connection F6.3 type DCLDD11000		

## electronics

## PCBs



1

<b>Part No.</b>	402447	<b>Ref. No.</b>	A1500096
<b>description</b>	keypad PCB L 125mm W 35mm with front panel buttons 6		



1

<b>Part No.</b>	402497	<b>Ref. No.</b>	A1500098
<b>description</b>	keypad PCB L 83mm W 48mm with display buttons 4		



1

<b>Part No.</b>	402495	<b>Ref. No.</b>	A1500097
<b>description</b>	PCB L 74mm W 64mm 230V		

## central units



1

<b>Part No.</b>	402456	<b>Ref. No.</b>	A1500095
<b>description</b>	central unit 3-group 230V 50/60Hz type SDE3D FI3NBV6		

1

Part No.	402454	Ref. No.	A1500070
description	central unit 3-group 230V type SDE3D FI3NAV6		

dosing electronics

miscellaneous



1

Part No.	402455	Ref. No.	A1500073
description	dosing electronics 230V 50/60Hz type SDE11		

keypads

front foils



1

Part No.	402453	Ref. No.	A2400055
description	front foil for keypad chrome-plated L 132mm W 42mm		



1

Part No.	402452	Ref. No.	A1500093
description	keypad foil coffee machine MIA L 79mm W 54mm buttons 6		



1

Part No.	402450	Ref. No.	A1500059
description	keypad foil grey L 164mm W 34mm buttons 6		



1

Part No.	402451	Ref. No.	A1500094
description	keypad foil L 79mm W 54mm buttons 2		



1

Part No.	525111	Ref. No.	A2400054
description	keypad foil L 90mm W 49mm buttons 4		

keypad units



1

Part No.	402448	Ref. No.	A1500092
description	keypad unit buttons 2 L 88mm W 60mm		



1

Part No.	402446	Ref. No.	A1500034
description	keypad unit buttons 6 grey L 164mm W 34mm		



1

Part No.	402449	Ref. No.	A1500091
description	keypad unit coffee machine FIorenzato buttons 6 L 88mm W 60mm		

solenoid valves

solenoid valves (water)

metal

ODE

solenoid valves steam (water)

21A series



1

Part No.	370573	Ref. No.	A1900002
description	solenoid valve brass 2-ways 230VAC inlet 1/8" outlet 1/8" connection 1/8" L 40mm DN 2.5mm -10 up to 140°C type series 21A coil type ADA membranes FKM (water/steam) p max 14bar 50Hz		
accessories for	370573		
	Part No.	371091	Ref. No. -
	power socket plug type DIN 43650B cable lengthmm small		





31A1 series



1

<b>Part No.</b>	370572	<b>Ref. No.</b>	A1900003
<b>description</b>	solenoid valve brass 3-ways 230VAC DN 1.5mm -10 up to 140°C coil type ADA membranes ruby p max 15bar p min 0bar flange 32x32mm		

4827K series



1

<b>Part No.</b>	370571	<b>Ref. No.</b>	A1900068
<b>description</b>	solenoid valve brass 2-ways 230VAC DN 2mm -10 up to 140°C coil type ADA membranes FKM (water/steam) p max 22bar p min 0bar 50Hz flange 32x32mm		

solenoid valves (various)



1

<b>Part No.</b>	370119	<b>Ref. No.</b>	A1900029
<b>description</b>	solenoid valve 2-ways 230VAC flange 25x25mm		

pressure switches

for coffee machines

ø 38mm



1

<b>Part No.</b>	541725	<b>Ref. No.</b>	A2100051
<b>description</b>	pressure control ø 38mm pressure range 0.5-1.2bar 21A 250V connection 1/4" 1CO pressure connection 1/4"		



1

<b>Part No.</b>	541726	<b>Ref. No.</b>	A2100305
<b>description</b>	pressure control ø 38mm pressure range 0.5-1.5bar 16A 250V connection 1/4" pressure connection 1/4"		

electrodes



1

<b>Part No.</b>	402457	<b>Ref. No.</b>	A1400001
<b>description</b>	level electrode 1/4" total length 145mm probe L 124mm insulated probe length 20mm connection curved ø 2.5mm		



1

<b>Part No.</b>	402458	<b>Ref. No.</b>	A1400003
<b>description</b>	level electrode 1/4" total length 75mm probe L 54mm insulated probe length 20mm connection curved ø 2.5mm		

motors

motors

for coffee grinders

components



1

<b>Part No.</b>	500239	<b>Ref. No.</b>	190067 270012
<b>description</b>	motor 230V 50Hz 1 phase ø 100mm ID ø 65mm H 195mm shaft ø 16mm type T48		

1

<b>Part No.</b>	500238	<b>Ref. No.</b>	190050 270003
<b>description</b>	motor 230V 50Hz 1 phase ø 110mm ID ø 65mm H 160mm shaft ø 14mm type T80		

## condensators & interference suppression filters

### operating capacitors

plastic



1

<b>Part No.</b>	365019	<b>Ref. No.</b>	A3200030
<b>description</b>	operating capacitor capacity 20µF 400V tolerance 5% 50/60Hz ambient temperature max. -25 to +85°C ø 39.5mm L 70mm M8 plastic connection male faston 6.3mm 16.10.25. protection		

## equipment-specific units

### for espresso machines

#### filter holders

#### filter holders standard

#### filter holders (complete)



1

<b>Part No.</b>	525097	<b>Ref. No.</b>	A2200079
<b>description</b>	filter holder 2-way complete ID ø 61.8mm outlet distance 55mm mounting ø 82.4		

filters

for 1 cup



1

<b>Part No.</b>	526261	<b>Ref. No.</b>	A2200221
<b>description</b>	coffee filter ø 70mm mounting ø 60.5mm H 20.5mm cups 1 amount of coffee 6.5g		



1

<b>Part No.</b>	529011	<b>Ref. No.</b>	A2200028
<b>description</b>	coffee filter ø 70mm mounting ø 60mm H 24.5mm cups 1 amount of coffee 7g perforation ø 0.4mm		

for 2 cups



1

<b>Part No.</b>	529197	<b>Ref. No.</b>	A2200029
<b>description</b>	coffee filter ø 70mm mounting ø 60mm H 24.5mm cups 2 amount of coffee 14g		

#### filter holder springs



1

<b>Part No.</b>	531243	<b>Ref. No.</b>	N/A
<b>description</b>	filter holder spring L 70mm W 60mm wire gauge ø 1.3mm for espresso filter holder Qty 20 pcs		

#### brewing units

#### shower screens

#### flat



1

<b>Part No.</b>	529228	<b>Ref. No.</b>	A2200235
<b>description</b>	shower screen ø 51.6mm hole ø 6.2mm		





## with upstand



1

<b>Part No.</b>	528417	<b>Ref. No.</b>	A2200031
<b>description</b>	shower screen $\varnothing$ 58mm H 19mm		

## filter holder gaskets

## flat

## with internal notch



1

<b>Part No.</b>	525105	<b>Ref. No.</b>	A1200181
<b>description</b>	filter holder gasket with inside notch D1 $\varnothing$ 72mm D2 $\varnothing$ 56mm H 8mm with inside notch Qty 1 pcs		

## standard



1

<b>Part No.</b>	528031	<b>Ref. No.</b>	A1200006
<b>description</b>	filter holder gasket D1 $\varnothing$ 73mm D2 $\varnothing$ 57mm H 8.5mm rubber Qty 1 pcs		



1

<b>Part No.</b>	525104	<b>Ref. No.</b>	A1200007
<b>description</b>	filter holder gasket D1 $\varnothing$ 73mm D2 $\varnothing$ 57mm H 8mm Qty 1 pcs		

## shim gaskets



1







<b>Part No.</b>	525103	<b>Ref. No.</b>	A1200033
<b>description</b>	shim gasket D1 $\varnothing$ 72mm D2 $\varnothing$ 58mm thickness 0.6mm paper Qty 1 pcs		

## brewing units with solenoid valve

## universal



1

<b>Part No.</b>	525495	<b>Ref. No.</b>	A2200035	
<b>description</b>	brewing unit for solenoid valve model E61			
<b>spare parts for</b>	525495			
	<b>Part No.</b>	529081	<b>Ref. No.</b>	—
	<b>description</b>	water distributor $\varnothing$ 30mm hole $\varnothing$ 1.5mm H 15mm ET M10x1 grooves 6 2.5mm brass		
<b>accessories for</b>	525495			
	<b>Part No.</b>	370057	<b>Ref. No.</b>	—
	<b>description</b>	solenoid valve 3-ways 230VAC body outer cone DN 1.2mm slide-on receptacle DIN -20° up to 140°C PARKER type series VE-128 coil type ZB09 membranes ruby p max 10bar brass flange 32x32mm		
	<b>Part No.</b>	525984	<b>Ref. No.</b>	—
	<b>description</b>	filter holder suitable for AURORA/BRASILIA/FAEMA without outlet mounting $\varnothing$ 82.5mm outlet 3/8" ID $\varnothing$ 62mm wedge height 10.5mm wedge position horizontal number of wedges 2 lever straight		
	<b>Part No.</b>	528030	<b>Ref. No.</b>	—
	<b>description</b>	filter holder gasket D1 $\varnothing$ 72.7mm D2 $\varnothing$ 57.2mm H 8mm Qty 1 pcs		
	<b>Part No.</b>	528165	<b>Ref. No.</b>	—
	<b>description</b>	group gasket L 76mm W 72mm thickness 2.5mm aperture 26x64mm hole distance 55mm		
	<b>Part No.</b>	528417	<b>Ref. No.</b>	A2200031
	<b>description</b>	shower screen $\varnothing$ 58mm H 19mm		

## brewing units manual

## components

## drain units

## drain valves



1

<b>Part No.</b>	526002	<b>Ref. No.</b>	A2200208
<b>description</b>	valve support $\varnothing$ 16mm L 27mm brass shaft triangular D1 $\varnothing$ 10mm D2 $\varnothing$ 7mm		



gaskets			
1			
<b>Part No.</b>	529795	<b>Ref. No.</b>	A1200160
<b>description</b>	gasket D1 ø 13mm D2 ø 4mm thickness 4mm coffee machine		

nozzle holders			
1			
<b>Part No.</b>	526783	<b>Ref. No.</b>	02102300
<b>description</b>	nozzle holder thread M30x1.5 IT M16x1.5 IT 1 M8 ø 26mm int. ø 1 15mm int. ø 2 17.5mm L 66.5mm total length 82mm WS 36 chrome-plated brass		

springs			
1			
<b>Part No.</b>	527935	<b>Ref. No.</b>	A2200209
<b>description</b>	compression spring ø 14.6mm L 33mm wire gauge ø 2mm		

camshafts			
1			
<b>Part No.</b>	527940	<b>Ref. No.</b>	A2200188
<b>description</b>	camshaft shaft ø 8mm shaft intake ø 6.2mm L 86.5mm W 20mm H 17mm thread M6 brass		

valves			
1			
<b>Part No.</b>	526008	<b>Ref. No.</b>	A2200178
<b>description</b>	valve group outflow L 54.3mm ED ø 16mm shaft ø 4.5mm brass		
<b>accessories for</b>	526008		
	<b>Part No.</b>	<b>Ref. No.</b>	—
	compression spring ø 13.8mm L 54.5mm wire gauge ø 1.5mm windings 10 drain valve		
	<b>Part No.</b>	<b>Ref. No.</b>	—
	O-ring NBR 787/70 thickness 2.62mm ID ø 9.13mm Qty 10 pcs		

1			
<b>Part No.</b>	526007	<b>Ref. No.</b>	A2200180
<b>description</b>	valve group supply L 52.8mm ED ø 16mm shaft triangular		

components			
nozzles			
with thread			
1			
<b>Part No.</b>	528486	<b>Ref. No.</b>	A2200174
<b>description</b>	nozzle bore ø 0.7mm thread M6x0.75 L 9mm WS 7		

springs			
1			
<b>Part No.</b>	526561	<b>Ref. No.</b>	A2200192
<b>description</b>	compression spring ø 14.3mm L 21mm wire gauge ø 1.8mm		

expansion valves			
with hose connection			
1			
<b>Part No.</b>	525096	<b>Ref. No.</b>	A1300028 A1300113
<b>description</b>	expansion valve T1: 1/8" ET hose ø 9mm total length 47mm		

1			
<b>Part No.</b>	525703	<b>Ref. No.</b>	A1300028 A1300113
<b>description</b>	expansion valve T1: 1/8" ET hose ø 9mm total length 47mm		

gasket supports			
1			
<b>Part No.</b>	526017	<b>Ref. No.</b>	A2200203
<b>description</b>	gasket support D1 ø 16mm D2 ø 10mm ID ø 7mm L 25mm square brass		



## drain pans

## drain pans



1

Part No.	527946	Ref. No.	A1600002
description	drain pan L 69mm W 79mm H 54mm hose ø 14mm		



1

Part No.	526564	Ref. No.	A1600134
description	drain pan ø 60mm H 46mm hole ø 20mm hose ø 10mm		

## aerators and air bleeders



1

Part No.	527981	Ref. No.	A1300007
description	aerator and air bleeder connection 1/4"		

## steam/water taps

## steam/water taps

## steam/water taps



1

Part No.	525098	Ref. No.	A2200021
description	steam/water tap with gasket, spring and bush inlet 3/8" outlet 3/8" shaft 6.5x8 shaft L 30mm brass		

## steam taps

## steam taps (complete)



1

Part No.	527954	Ref. No.	A2200066
description	steam tap mounting pos. external inlet 3/8" outlet 3/8" chrome-plated brass		



1

Part No.	525094	Ref. No.	A2200048
description	steam tap with lever inlet 3/8" outlet 3/8" chrome-plated brass		

## miscellaneous



1

Part No.	526017	Ref. No.	A2200203
description	gasket support D1 ø 16mm D2 ø 10mm ID ø 7mm L 25mm square brass		

## components

## gaskets



1

Part No.	529795	Ref. No.	A1200160
description	gasket D1 ø 13mm D2 ø 4mm thickness 4mm coffee machine		

## springs



1

Part No.	525093	Ref. No.	A2200002
description	compression spring ø 10.6mm L 29.5mm wire gauge ø 1.4mm		

## steam/water pipes

## steam pipes



1

Part No.	525102	Ref. No.	A2000090
description	steam pipe H 150mm W 70mm tube ø 8mm chrome-plated brass		



1

<b>Part No.</b>	525100	<b>Ref. No.</b>	A2200014
<b>description</b>	steam pipe mounting pos. left thread 3/8" H 200mm tube ø 8mm chrome-plated brass		

1

<b>Part No.</b>	525101	<b>Ref. No.</b>	A2200015
<b>description</b>	steam pipe mounting pos. right thread 3/8" H 200mm tube ø 8mm chrome-plated brass		

nozzles for steam pipes

1

<b>Part No.</b>	525099	<b>Ref. No.</b>	A2200044
<b>description</b>	steam nozzle thread M10x1 ø 12mm L 14mm thread L 6mm 4 holes bore ø 1.5mm chrome-plated brass		

nozzles for water pipes

1

<b>Part No.</b>	525095	<b>Ref. No.</b>	A2200012
<b>description</b>	nozzle D1 ø 24mm H 30mm thread M10x1 int. ø 19mm		

accessories

gaskets

1

<b>Part No.</b>	528402	<b>Ref. No.</b>	A1200030
<b>description</b>	O-ring Viton thickness 2.62mm ID ø 10.78mm Qty 1 pcs		

1

<b>Part No.</b>	528231	<b>Ref. No.</b>	A1200028
<b>description</b>	O-ring Viton thickness 2.62mm ID ø 12.37mm Qty 1 pcs		

union nuts

1

<b>Part No.</b>	528826	<b>Ref. No.</b>	A2200036
<b>description</b>	union nut thread 3/8" L 21mm hole ø 12.5mm chrome-plated brass		

gaskets

flat gaskets

rubber gaskets

1

<b>Part No.</b>	525107	<b>Ref. No.</b>	A1200155
<b>description</b>	flat gasket rubber ED ø 16mm ID ø 8mm thickness 4mm Qty 1 pcs		

fine filters

1

<b>Part No.</b>	529979	<b>Ref. No.</b>	A2200175
<b>description</b>	fine filter ø 8.8mm H 22mm		

intake valves

accessories

springs

1

<b>Part No.</b>	526560	<b>Ref. No.</b>	A2200177
<b>description</b>	compression spring ø 14.3mm L 46mm wire gauge ø 1.5mm		

level glasses

level glasses

level glass pipes

1

<b>Part No.</b>	529407	<b>Ref. No.</b>	A1400008
<b>description</b>	water level tube ø 11mm H 170mm ID ø 8mm		



## non-return valves

## pistons



1

<b>Part No.</b>	526009	<b>Ref. No.</b>	A2200215
-----------------	--------	-----------------	----------

<b>description</b>	piston for non-return valve with O-ring $\varnothing$ 12mm L 20mm		
--------------------	---	--	--

## complete



1

<b>Part No.</b>	529335	<b>Ref. No.</b>	A1300056
-----------------	--------	-----------------	----------

<b>description</b>	non-return valve inlet 1/8" outlet 1/8" L 30mm		
--------------------	--	--	--



1

<b>Part No.</b>	527978	<b>Ref. No.</b>	A1300109
-----------------	--------	-----------------	----------

<b>description</b>	non-return valve inlet 3/8" outlet 3/8" L 38mm		
--------------------	--	--	--

## for coffee grinders

## grinding burrs

## grinding burrs straight

## standard



1

<b>Part No.</b>	527227	<b>Ref. No.</b>	260001 260003 A3200063
-----------------	--------	-----------------	------------------------------

<b>description</b>	grinding burrs pair turn direction right D1 $\varnothing$ 63mm ID $\varnothing$ 38mm H 9.5mm tooth spacing 3mm hole $\varnothing$ 5.5mm bore $\varnothing$ 8.5mm mounting $\varnothing$ 48 straight suitable for FIORENZATO		
--------------------	---	--	--



1

<b>Part No.</b>	527228	<b>Ref. No.</b>	260001 260003 A3200083
-----------------	--------	-----------------	------------------------------

<b>description</b>	grinding burrs pair turn direction right D1 $\varnothing$ 83mm ID $\varnothing$ 45mm H 10mm tooth spacing 4mm hole $\varnothing$ 5.4mm bore $\varnothing$ 10mm mounting $\varnothing$ 64.5 straight suitable for FIORENZATO		
--------------------	---	--	--

## grinding burrs holders



1

<b>Part No.</b>	527260	<b>Ref. No.</b>	170090 340182
-----------------	--------	-----------------	------------------

<b>description</b>	grinding burr holder D1 $\varnothing$ 63mm D2 $\varnothing$ 80mm H 31mm type T80 suitable for FIORENZATO		
--------------------	--	--	--



1

<b>Part No.</b>	527261	<b>Ref. No.</b>	340183
-----------------	--------	-----------------	--------

<b>description</b>	grinding burr holder D1 $\varnothing$ 83mm D2 $\varnothing$ 90mm H 34mm type T45 suitable for FIORENZATO		
--------------------	--	--	--

## miscellaneous



1

<b>Part No.</b>	802047	<b>Ref. No.</b>	160097
-----------------	--------	-----------------	--------

<b>description</b>	equipment foot rubber $\varnothing$ mm H 22mm mounting measurements 31x18mm T80 Qty 1 pcs		
--------------------	---	--	--

## dosing containers

## dosing containers (complete)



1

<b>Part No.</b>	527508	<b>Ref. No.</b>	340123 RMT480006 RMUNIO007
-----------------	--------	-----------------	----------------------------------

<b>description</b>	dosing unit $\varnothing$ 120mm suitable for T80		
--------------------	--	--	--



dosing container lids



1			
<b>Part No.</b>	527320	<b>Ref. No.</b>	160064
<b>description</b>	lid for dosing container mounting ø 114mm ø 122mm H 22mm suitable for M80		



1			
<b>Part No.</b>	525166	<b>Ref. No.</b>	A320008
<b>description</b>	lid for dosing container mounting ø 116mm ø 130mm H 25mm		



1			
<b>Part No.</b>	527323	<b>Ref. No.</b>	160078
<b>description</b>	lid for dosing container mounting ø 130mm ø 135mm H 24mm		

adjusting screws



1			
<b>Part No.</b>	527500	<b>Ref. No.</b>	340120
<b>description</b>	adjusting screw for dosing container thread M8 L 40mm plastic		

springs

group 1



1			
<b>Part No.</b>	525110	<b>Ref. No.</b>	A3200049
<b>description</b>	tension spring ø 7.5mm total length 42mm wire gauge ø 0.8mm L1 29mm		

glass cylinders



1			
<b>Part No.</b>	525167	<b>Ref. No.</b>	A3200009
<b>description</b>	glass cylinder for dosing container ø 125mm H 53mm plexiglas		



1			
<b>Part No.</b>	527322	<b>Ref. No.</b>	160083 340231
<b>description</b>	glass cylinder ø 122mm H 10mm plexiglas		



1			
<b>Part No.</b>	527326	<b>Ref. No.</b>	160079
<b>description</b>	glass cylinder ø 132mm H 75mm plexiglas		

levers

levers



1			
<b>Part No.</b>	527507	<b>Ref. No.</b>	340159
<b>description</b>	lever complete L 110mm shaft ø 8mm plastic		

coffee presses

components

holders



1			
<b>Part No.</b>	525113	<b>Ref. No.</b>	A3200002
<b>description</b>	bracket H 22mm L 65mm plastic		

pressers



1			
<b>Part No.</b>	525112	<b>Ref. No.</b>	A3200001
<b>description</b>	coffee press ø 55mm H 34mm plastic		





## coffee presses



1

<b>Part No.</b>	527506	<b>Ref. No.</b>	160061
-----------------	--------	-----------------	--------

<b>description</b>	coffee press $\varnothing$ 57mm L 83mm H 41mm plastic
--------------------	---

## automatic grinding

## automatic grinding



1

<b>Part No.</b>	525114	<b>Ref. No.</b>	A3200084
-----------------	--------	-----------------	----------

<b>description</b>	housing for microswitch $\varnothing$ 116mm H 45mm plastic
--------------------	--

## sector plates



1

<b>Part No.</b>	527502	<b>Ref. No.</b>	160073
-----------------	--------	-----------------	--------

<b>description</b>	sector plates plastic
--------------------	-----------------------

## stars

## central



1

<b>Part No.</b>	527503	<b>Ref. No.</b>	340196
-----------------	--------	-----------------	--------

<b>description</b>	star mounting pos. centre/bottom
--------------------	----------------------------------

## upper



1

<b>Part No.</b>	527501	<b>Ref. No.</b>	160072
-----------------	--------	-----------------	--------

<b>description</b>	star mounting pos. upper $\varnothing$ 107mm hole $\varnothing$ 8mm H 39mm
--------------------	--

## bottom



1

<b>Part No.</b>	527503	<b>Ref. No.</b>	340196
-----------------	--------	-----------------	--------

<b>description</b>	star mounting pos. centre/bottom
--------------------	----------------------------------

## adjustment mechanism

## setting rings



1

<b>Part No.</b>	527412	<b>Ref. No.</b>	340181
-----------------	--------	-----------------	--------

<b>description</b>	setting ring mounting $\varnothing$ 95mm $\varnothing$ 111mm ID $\varnothing$ 68mm H 41mm suitable for FIORENZATO for T45 equiv. no. 340181
--------------------	---



1

<b>Part No.</b>	527410	<b>Ref. No.</b>	340147
-----------------	--------	-----------------	--------

<b>description</b>	setting ring $\varnothing$ 106mm ID $\varnothing$ 68mm H 30mm suitable for FIORENZATO for T80
--------------------	---

## coffee beans containers

## container lids



1

<b>Part No.</b>	527313	<b>Ref. No.</b>	160149
-----------------	--------	-----------------	--------

<b>description</b>	lid for coffee beans container mounting $\varnothing$ 174mm $\varnothing$ 178mm
--------------------	---



1

<b>Part No.</b>	527315	<b>Ref. No.</b>	160081 A3200028
-----------------	--------	-----------------	--------------------

<b>description</b>	lid for coffee beans container mounting $\varnothing$ 200mm $\varnothing$ 204mm
--------------------	---



coffee beans containers



1

<b>Part No.</b>	527312	<b>Ref. No.</b>	340066
<b>description</b>	coffee beans container 3-piece seat ø 68mm		



1

<b>Part No.</b>	527311	<b>Ref. No.</b>	340068 RMT800012
<b>description</b>	coffee beans container complete ø 175mm H 220mm seat ø 68mm container capacity 1.2kg T80		





1

<b>Part No.</b>	527314	<b>Ref. No.</b>	160080
<b>description</b>	coffee beans container ø 172mm H 222mm seat ø 67mm M80		
<b>accessories for</b>	527314		
	<b>Part No.</b>	527313	<b>Ref. No.</b> 160149
	lid for coffee beans container mounting ø 174mm ø 178mm		
	<b>Part No.</b>	527318	<b>Ref. No.</b> 160063 A3200031
	catch L 86mm W 48mm thickness 2mm plastic		
	<b>Part No.</b>	527319	<b>Ref. No.</b> 160067
	protection cap ø 60mm suitable for FIORENZATO plexiglas		



1

<b>Part No.</b>	527316	<b>Ref. No.</b>	160076 A3200027
<b>description</b>	coffee beans container ø 200mm H 255mm seat ø 67mm M1-T48		
<b>spare parts for</b>	527316		
	<b>Part No.</b>	527315	<b>Ref. No.</b> 160081 A3200028
	lid for coffee beans container mounting ø 200mm ø 204mm		
	<b>Part No.</b>	527318	<b>Ref. No.</b> 160063 A3200031
	catch L 86mm W 48mm thickness 2mm plastic		
	<b>Part No.</b>	527319	<b>Ref. No.</b> 160067
	protection cap ø 60mm suitable for FIORENZATO plexiglas		

protection caps



1

<b>Part No.</b>	527319	<b>Ref. No.</b>	160067
<b>description</b>	protection cap ø 60mm suitable for FIORENZATO plexiglas		



1

<b>Part No.</b>	527411	<b>Ref. No.</b>	160091
<b>description</b>	protection cap ø 68mm plastic		

locks



1

<b>Part No.</b>	527318	<b>Ref. No.</b>	160063 A3200031
<b>description</b>	catch L 86mm W 48mm thickness 2mm plastic		

support for filter holder



1

<b>Part No.</b>	527518	<b>Ref. No.</b>	170033 170044
<b>description</b>	bracket for filter holder L 105mm W 57mm H 15mm aluminium		

counters

counters



1

<b>Part No.</b>	527505	<b>Ref. No.</b>	210033
<b>description</b>	counter ø 20mm lever length 35mm for dosing unit		

knobs

steam/water taps

steam/water taps



1

<b>Part No.</b>	111328	<b>Ref. No.</b>	A1600012
<b>description</b>	turning handle ø 44mm shaft ø 6x8mm black		

handles and hand wheels

cone handles



1

<b>Part No.</b>	111327	<b>Ref. No.</b>	A1600172
<b>description</b>	cone handle thread M8 ø 30mm L 66mm thermoplastic black		

star handles

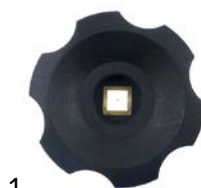

1

<b>Part No.</b>	111333	<b>Ref. No.</b>	A1600004
<b>description</b>	star handle shaft 7x7mm ø 60mm L 24mm black thermoplastic		

equipment feet and end caps

equipment feet with stem



1

<b>Part No.</b>	802047	<b>Ref. No.</b>	160097
<b>description</b>	equipment foot rubber ømm H 22mm mounting measurements 31x18mm T80 Qty 1 pcs		



**gaskets**

**O-rings**

**EPDM**

1

<b>Part No.</b>	510177	<b>Ref. No.</b>	A1200039
<b>description</b>	O-ring EPDM thickness 1.78mm ID ø 7.66mm Qty 1 pcs		

1

<b>Part No.</b>	529412	<b>Ref. No.</b>	A1200040
<b>description</b>	O-ring EPDM thickness 2.62mm ID ø 10.78mm Qty 1 pcs		

**Viton**

1

<b>Part No.</b>	528402	<b>Ref. No.</b>	A1200030
<b>description</b>	O-ring Viton thickness 2.62mm ID ø 10.78mm Qty 1 pcs		

1

<b>Part No.</b>	528231	<b>Ref. No.</b>	A1200028
<b>description</b>	O-ring Viton thickness 2.62mm ID ø 12.37mm Qty 1 pcs		

1

<b>Part No.</b>	532560	<b>Ref. No.</b>	A1200151
<b>description</b>	O-ring Viton thickness 2.62mm ID ø 20.63mm Qty 1 pcs		

**sealing washers**

**rubber gaskets**

1

<b>Part No.</b>	525107	<b>Ref. No.</b>	A1200155
<b>description</b>	flat gasket rubber ED ø 16mm ID ø 8mm thickness 4mm Qty 1 pcs		

**PTFE gaskets**

1

<b>Part No.</b>	527638	<b>Ref. No.</b>	A1200044
<b>description</b>	flat gasket PTFE ED ø 12mm ID ø 10mm thickness 1mm Qty 1 pcs		

1

<b>Part No.</b>	527154	<b>Ref. No.</b>	A1200153
<b>description</b>	flat gasket PTFE ED ø 22mm ID ø 16.8mm thickness 2mm Qty 1 pcs		

1

<b>Part No.</b>	526013	<b>Ref. No.</b>	A1200011
<b>description</b>	flat gasket PTFE ED ø 22mm ID ø 17mm thickness 2mm Qty 1 pcs		

1

<b>Part No.</b>	526265	<b>Ref. No.</b>	A1200009
<b>description</b>	flat gasket PTFE ED ø 24mm ID ø 19mm thickness 2mm Qty 1 pcs		

1

<b>Part No.</b>	525106	<b>Ref. No.</b>	A1200158
<b>description</b>	flat gasket PTFE ED ø 26mm ID ø 19mm thickness 2mm Qty 1 pcs		

1

<b>Part No.</b>	526014	<b>Ref. No.</b>	A1200152
<b>description</b>	flat gasket PTFE ED ø 35mm ID ø 30mm thickness 2mm Qty 1 pcs		





			
1			
<b>Part No.</b>	528021	<b>Ref. No.</b>	A1200015
<b>description</b>			

## springs

### compression springs

			
1			
<b>Part No.</b>	527504	<b>Ref. No.</b>	230023
<b>description</b>	compression spring ø 10.3mm L 60mm wire gauge ø 1.3mm		

			
1			
<b>Part No.</b>	525093	<b>Ref. No.</b>	A2200002
<b>description</b>	compression spring ø 10.6mm L 29.5mm wire gauge ø 1.4mm		

			
1			
<b>Part No.</b>	525092	<b>Ref. No.</b>	A2200001
<b>description</b>	compression spring ø 12mm L 15mm wire gauge ø 1.5mm		

			
1			
<b>Part No.</b>	526561	<b>Ref. No.</b>	A2200192
<b>description</b>	compression spring ø 14.3mm L 21mm wire gauge ø 1.8mm		

			
1			
<b>Part No.</b>	526560	<b>Ref. No.</b>	A2200177
<b>description</b>	compression spring ø 14.3mm L 46mm wire gauge ø 1.5mm		

			
1			
<b>Part No.</b>	527935	<b>Ref. No.</b>	A2200209
<b>description</b>	compression spring ø 14.6mm L 33mm wire gauge ø 2mm		

## tension springs

			
1			
<b>Part No.</b>	525110	<b>Ref. No.</b>	A3200049
<b>description</b>	tension spring ø 7.5mm total length 42mm wire gauge ø 0.8mm L1 29mm		

## manometers

			
1			
<b>Part No.</b>	541727	<b>Ref. No.</b>	A1400019
<b>description</b>	manometer double scale ø 63mm pressure range 0-3 / 0-18bar connection on the backside thread 1/8"		

			
1			
<b>Part No.</b>	541728	<b>Ref. No.</b>	A1400020
<b>description</b>	manometer double scale ø 63mm pressure range 0-3 / 0-18bar connection on the backside thread 1/8"		

			
1			
<b>Part No.</b>	541200	<b>Ref. No.</b>	A1400042
<b>description</b>	manometer ø 52mm pressure range 0 up to 3bar connection on the backside marking 0.7-1 thread 1/8"		

			
1			
<b>Part No.</b>	541201	<b>Ref. No.</b>	A1400043
<b>description</b>	manometer ø 53.5mm pressure range 0 up to 16bar connection on the backside thread 1/8"		



## fastening material

### screws

#### countersunk screws



1

<b>Part No.</b>	560215	<b>Ref. No.</b>	A1100187
<b>description</b>	countersunk screw thread M5 L 14mm SS DIN 963/ISO 2009 Qty 20 pcs intake slotted head ø 9.2mm		



**GASTRO**PARTS.COM

