



**GASTROPARTS**

# Anliker

- [EN]** Equipment
- [DE]** Geräte
- [ES]** Aparatos
- [FR]** Équipement
- [IT]** Attrezzature
- [PL]** Urządzenia
- [RU]** Оборудование

✉ [gastroparts@gastroparts.com](mailto:gastroparts@gastroparts.com)

☎ +48 56 657 00 66

📘 [fb.com/gastroparts.global](https://fb.com/gastroparts.global)

**GASTROPARTS.COM**





## heating elements

### accessories

#### hexagonal nuts



1

<b>Part No.</b>	560131	<b>Ref. No.</b>	810.10022
<b>description</b>	hexagonal nut thread M4 H 3.2mm WS 7 SS DIN/ISO DIN 934 / ISO 4032/8673 Qty 20 pcs		
<b>For models:</b>	GSM-anlikerXL-STANDARD, GSM-anlikerXL-STAR, GSM-FIVE-STANDARD, GSM-FIVE-STAR, GSM-Quattro-PROFI, GSM-Quattro-STANDARD		



1

<b>Part No.</b>	560132	<b>Ref. No.</b>	810.10032
<b>description</b>	hexagonal nut thread M5 H 4mm WS 8 SS DIN/ISO DIN 934 / ISO 4032/8673 Qty 20 pcs		
<b>For models:</b>	GSM-anlikerXL-STANDARD, GSM-anlikerXL-STAR, GSM-FIVE-STANDARD, GSM-FIVE-STAR, GSM-Quattro-PROFI, GSM-Quattro-STANDARD		

#### washers



1

<b>Part No.</b>	560111	<b>Ref. No.</b>	812.60032
<b>description</b>	plain washer ID $\varnothing$ 4.3mm ED $\varnothing$ 9mm thickness 0.8mm SS Qty 20 pcs DIN 125A for thread M4		
<b>For models:</b>	GSM-FIVE-STANDARD, GSM-FIVE-STAR, GSM-Quattro-PROFI, GSM-Quattro-STANDARD		



1

<b>Part No.</b>	560112	<b>Ref. No.</b>	812.10032
<b>description</b>	plain washer ID $\varnothing$ 5.3mm ED $\varnothing$ 10mm thickness 1mm SS Qty 20 pcs DIN 125A for thread M5		
<b>For models:</b>	GSM-anlikerXL-STANDARD, GSM-anlikerXL-STAR, GSM-FIVE-STANDARD, GSM-FIVE-STAR, GSM-Quattro-PROFI, GSM-Quattro-STANDARD		

#### tooth lock washers



1

<b>Part No.</b>	560125	<b>Ref. No.</b>	814.20022
<b>description</b>	tooth lock washer ID $\varnothing$ 4.2mm ED $\varnothing$ 8mm SS DIN/ISO DIN 6798A Qty 20 pcs for thread M4		
<b>For models:</b>	GSM-FIVE-STANDARD, GSM-FIVE-STAR, GSM-Quattro-PROFI, GSM-Quattro-STANDARD		

## switches and momentary switches

### magnetic switches

#### M8x1.25



1

<b>Part No.</b>	347558	<b>Ref. No.</b>	708.04020
<b>description</b>	magnetic switch 1NO thread M8x1.25 cable length 300mm		
<b>For models:</b>	GSM-anlikerXL-STANDARD, GSM-anlikerXL-STAR, GSM-FIVE-STANDARD, GSM-FIVE-STAR, GSM-Quattro-PROFI, GSM-Quattro-STANDARD		

## motors

### motors

#### for vegetable slicers



1

<b>Part No.</b>	499124	<b>Ref. No.</b>	235.91815
<b>description</b>	motor 230V 260W 50Hz 2760rpm 1 phase shaft $\varnothing$ 14mm shaft length 61mm $\varnothing$ 116mm H 218mm mounting distance 144.5mm hole $\varnothing$ 6mm		
<b>For models:</b>	GSM-FIVE-STANDARD, GSM-FIVE-STAR, GSM-Quattro-PROFI, GSM-Quattro-STANDARD		

## condensators & interference suppression filters

### operating capacitors

#### plastic



1

<b>Part No.</b>	365146	<b>Ref. No.</b>	705.01014
<b>description</b>	operating capacitor capacity 50 $\mu$ F 250V with plastic sheathing tolerance $\pm$ 5% 50/60Hz $\varnothing$ 45mm L 72mm connection male faston 6.3mm		
<b>For models:</b>	GSM-anlikerXL-STANDARD, GSM-anlikerXL-STAR		



			
1			
<b>Part No.</b>	365147	<b>Ref. No.</b>	705.01013
<b>description</b>	operating capacitor capacity 60µF 250V with plastic sheathing tolerance ± 5% 50/60Hz ø 45mm L 96mm connection male faston 6.3mm		
<b>For models:</b>	GSM-anlikerXL-STANDARD, GSM-anlikerXL-STAR		

			
1			
<b>Part No.</b>	365013	<b>Ref. No.</b>	705.01015
<b>description</b>	operating capacitor capacity 8µF 400V tolerance 5%Hz ambient temperature max. -25 to +85°C ø 31.5mm L 55mm M8 plastic connection male faston 6.3mm protection		
<b>For models:</b>	GSM-FIVE-STANDARD, GSM-FIVE-STAR, GSM-Quattro-PROFI, GSM-Quattro-STANDARD		

<b>metal</b>			
			
1			
<b>Part No.</b>	365145	<b>Ref. No.</b>	705.01001
<b>description</b>	operating capacitor capacity 8µF 420/470V with metal case tolerance ± 5% 50/60Hz ø 30mm L 108mm connection male faston 6.3mm		
<b>For models:</b>	GSM-Quattro-PROFI, GSM-Quattro-STANDARD		

**fuses**

**fine fuses**

			
1			
<b>Part No.</b>	358509	<b>Ref. No.</b>	710.02007
<b>description</b>	fine fuse size ø5x20mm 0.05A slow-acting rated 250V Qty 1 pcs		
<b>For models:</b>	GSM-anlikerXL-STANDARD, GSM-anlikerXL-STAR, GSM-FIVE-STANDARD, GSM-FIVE-STAR		

**miscellaneous**

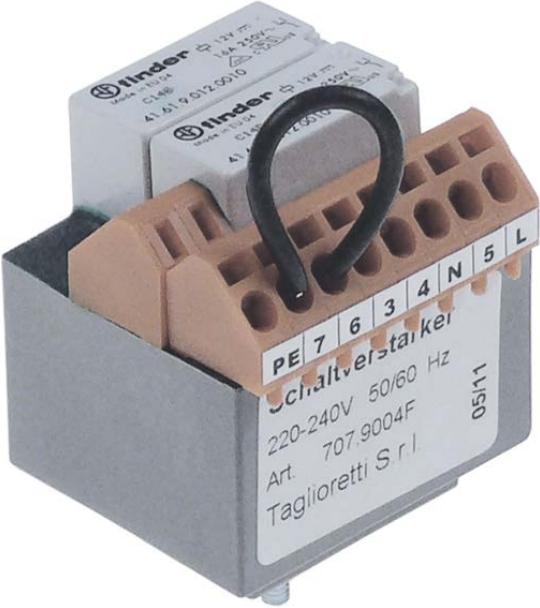
			
1			
<b>Part No.</b>	365148	<b>Ref. No.</b>	707.09004
<b>description</b>	switching amplifier 220-240V 50/60Hz		
<b>For models:</b>	GSM-anlikerXL-STANDARD, GSM-anlikerXL-STAR, GSM-FIVE-STANDARD, GSM-FIVE-STAR, GSM-Quattro-PROFI, GSM-Quattro-STANDARD		

**equipment-specific units**

**for vegetable slicers**

**press levers**

			
1			
<b>Part No.</b>	699117	<b>Ref. No.</b>	235.01608
<b>description</b>	plunger for vegetable slicer ø 125x55mm L 145mm W 125mm H 255mm		
<b>For models:</b>	GSM-Quattro-PROFI, GSM-Quattro-STANDARD		

**ejector discs**

			
1			
<b>Part No.</b>	699121	<b>Ref. No.</b>	235.01822
<b>description</b>	ejector H 21mm seat ø 29mm		
<b>For models:</b>	GSM-FIVE-STANDARD, GSM-FIVE-STAR, GSM-Quattro-PROFI, GSM-Quattro-STANDARD		



 <p>1</p>			
<b>Part No.</b>	699114	<b>Ref. No.</b>	232.01860
<b>description</b>	ejector disc flat H 33mm ø 180mm seat ø 29mm		
<b>For models:</b>	GSM-FIVE-STANDARD, GSM-FIVE-STAR		

<p>miscellaneous</p>			
 <p>1</p>			
<b>Part No.</b>	560466	<b>Ref. No.</b>	812.50960
<b>description</b>	adjusting washer ID ø 37mm ED ø 47mm thickness 0.1mm steel Qty 1 pcs DIN 988		
<b>For models:</b>	GSM-FIVE-STANDARD, GSM-FIVE-STAR		

 <p>1</p>			
<b>Part No.</b>	699122	<b>Ref. No.</b>	235.02604
<b>description</b>	bolt ø 9mm L 35mm thread M8x1.25 SS for vegetable slicer		
<b>For models:</b>	GSM-anlikerXL-STANDARD, GSM-anlikerXL-STAR, GSM-FIVE-STANDARD, GSM-FIVE-STAR		

 <p>1</p>			
<b>Part No.</b>	699116	<b>Ref. No.</b>	235.01607
<b>description</b>	bush ED ø 16mm ID ø 9.3mm L 15.5mm for catch		
<b>For models:</b>	GSM-Quattro-PROFI, GSM-Quattro-STANDARD		

 <p>1</p>			
<b>Part No.</b>	699123	<b>Ref. No.</b>	235.02605
<b>description</b>	bush ED ø 16mm ID ø 9.3mm L 21mm plastic for catch		
<b>For models:</b>	GSM-anlikerXL-STANDARD, GSM-anlikerXL-STAR, GSM-FIVE-STANDARD, GSM-FIVE-STAR		

 <p>1</p>			
<b>Part No.</b>	699125	<b>Ref. No.</b>	235.02620
<b>description</b>	flange ED ø 159mm ID ø 120mm H 101mm aluminium for vegetable slicer		
<b>For models:</b>	GSM-FIVE-STANDARD, GSM-FIVE-STAR, GSM-Quattro-PROFI, GSM-Quattro-STANDARD		

 <p>1</p>			
<b>Part No.</b>	699127	<b>Ref. No.</b>	733.05002
<b>description</b>	gearbox ED ø 109mm ID ø 87mm H 16mm plastic for vegetable slicer		
<b>For models:</b>	GSM-FIVE-STANDARD, GSM-FIVE-STAR, GSM-Quattro-PROFI, GSM-Quattro-STANDARD		

 <p>1</p>			
<b>Part No.</b>	699115	<b>Ref. No.</b>	235.01120
<b>description</b>	hinge pin ø 8mm L 25mm SS for vegetable slicer		
<b>For models:</b>	GSM-Quattro-PROFI, GSM-Quattro-STANDARD		

 <p>1</p>			
<b>Part No.</b>	699124	<b>Ref. No.</b>	235.02619
<b>description</b>	planet gear ø 45mm H 41mm thread M6 mounting distance 45mm for gearbox		
<b>For models:</b>	GSM-FIVE-STANDARD, GSM-FIVE-STAR		

 <p>1</p>			
<b>Part No.</b>	699118	<b>Ref. No.</b>	235.01644
<b>description</b>	shaft ø 5mm L 43.5mm thread M5 for plunger		
<b>For models:</b>	GSM-Quattro-PROFI, GSM-Quattro-STANDARD		



1

<b>Part No.</b>	699128	<b>Ref. No.</b>	735.01026
<b>description</b>	shaft sealing ED $\varnothing$ 40mm ID $\varnothing$ 30mm H 7mm plastic for vegetable slicer		
<b>For models:</b>	GSM-anlikerXL-STANDARD, GSM-anlikerXL-STAR, GSM-FIVE-STANDARD, GSM-FIVE-STAR		



1

<b>Part No.</b>	699120	<b>Ref. No.</b>	235.01811
<b>description</b>	slide bearing ED $\varnothing$ 68mm ID $\varnothing$ 60mm H 10mm plastic for vegetable slicer		
<b>For models:</b>	GSM-FIVE-STAR		



1

<b>Part No.</b>	699119	<b>Ref. No.</b>	235.01645
<b>description</b>	thread bolt $\varnothing$ 8mm L 30mm thread M5 SS for catch		
<b>For models:</b>	GSM-Quattro-PROFI, GSM-Quattro-STANDARD		



1

<b>Part No.</b>	699126	<b>Ref. No.</b>	731.03001
<b>description</b>	Thumb screw $\varnothing$ 19mm L 24mm thread M5 SS/plastic for vegetable slicer		
<b>For models:</b>	GSM-Quattro-PROFI, GSM-Quattro-STANDARD		

## gaskets

### O-rings

#### EPDM

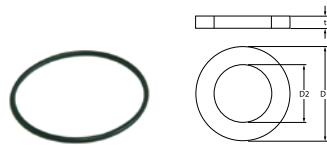

1

<b>Part No.</b>	512114	<b>Ref. No.</b>	825.20384
<b>description</b>	O-ring EPDM thickness 2.62mm ID $\varnothing$ 55.25mm Qty 1 pcs		
<b>For models:</b>	GSM-FIVE-STAR, GSM-Quattro-PROFI		

## shaft gaskets

### shaft gaskets



1

<b>Part No.</b>	699128	<b>Ref. No.</b>	735.01026
<b>description</b>	shaft sealing ED $\varnothing$ 40mm ID $\varnothing$ 30mm H 7mm plastic for vegetable slicer		
<b>For models:</b>	GSM-anlikerXL-STANDARD, GSM-anlikerXL-STAR, GSM-FIVE-STANDARD, GSM-FIVE-STAR		

## transmission technology and ball bearings

### ball bearings

#### deep-groove ball bearings 2RS



1

<b>Part No.</b>	523525	<b>Ref. No.</b>	823.30373
<b>description</b>	deep-groove ball bearing type 6005-2RS shaft $\varnothing$ 25mm ED $\varnothing$ 47mm W 12mm with sealing discs deep-groove ball bearing DIN 625-1		
<b>For models:</b>	GSM-FIVE-STANDARD, GSM-FIVE-STAR		

#### angular contact ball bearings



1

<b>Part No.</b>	523017	<b>Ref. No.</b>	823.20473
<b>description</b>	angular contact ball bearing shaft $\varnothing$ 30mm ED $\varnothing$ 55mm W 19mm type 3006-2RS DIN 628		
<b>For models:</b>	GSM-anlikerXL-STANDARD, GSM-anlikerXL-STAR		



## fastening material

## screws

## cylinder head bolts

DIN 912/ISO 4762



1

<b>Part No.</b>	560030	<b>Ref. No.</b>	801.30232
<b>description</b>	cylinder head bolt thread M5 thread L 25mm WS 4 SS Qty 20 pcs DIN 912/ISO 4762		
<b>For models:</b>	GSM-anlikerXL-STANDARD, GSM-anlikerXL-STAR, GSM-FIVE-STANDARD, GSM-FIVE-STAR, GSM-Quattro-PROFI, GSM-Quattro-STANDARD		

## side bolts



1

<b>Part No.</b>	560053	<b>Ref. No.</b>	802.30102
<b>description</b>	side bolts thread M5 L 16mm SS Qty 20 pcs intake slotted head $\varnothing$ 12.5mm		
<b>For models:</b>	GSM-anlikerXL-STANDARD, GSM-anlikerXL-STAR, GSM-FIVE-STANDARD, GSM-FIVE-STAR, GSM-Quattro-PROFI, GSM-Quattro-STANDARD		

## grub screws

DIN 914/ISO 4027



1

<b>Part No.</b>	560169	<b>Ref. No.</b>	808.60018
<b>description</b>	grub screw thread M3 L 4mm DIN 914/ISO 4027 WS 1.5 Qty 1 pcs		
<b>For models:</b>	GSM-FIVE-STANDARD, GSM-FIVE-STAR		

## knurled screws



1

<b>Part No.</b>	699126	<b>Ref. No.</b>	731.03001
<b>description</b>	Thumb screw $\varnothing$ 19mm L 24mm thread M5 SS/plastic for vegetable slicer		
<b>For models:</b>	GSM-Quattro-PROFI, GSM-Quattro-STANDARD		

## nuts

## hexagonal nuts

DIN 934 / ISO 4032/8673



1

<b>Part No.</b>	560131	<b>Ref. No.</b>	810.10022
<b>description</b>	hexagonal nut thread M4 H 3.2mm WS 7 SS DIN/ISO DIN 934 / ISO 4032/8673 Qty 20 pcs		
<b>For models:</b>	GSM-anlikerXL-STANDARD, GSM-anlikerXL-STAR, GSM-FIVE-STANDARD, GSM-FIVE-STAR, GSM-Quattro-PROFI, GSM-Quattro-STANDARD		



1

<b>Part No.</b>	560132	<b>Ref. No.</b>	810.10032
<b>description</b>	hexagonal nut thread M5 H 4mm WS 8 SS DIN/ISO DIN 934 / ISO 4032/8673 Qty 20 pcs		
<b>For models:</b>	GSM-anlikerXL-STANDARD, GSM-anlikerXL-STAR, GSM-FIVE-STANDARD, GSM-FIVE-STAR, GSM-Quattro-PROFI, GSM-Quattro-STANDARD		



1

<b>Part No.</b>	560134	<b>Ref. No.</b>	810.10052
<b>description</b>	hexagonal nut thread M8 H 6.5mm WS 13 SS DIN/ISO DIN 934 / ISO 4032/8673 Qty 20 pcs		
<b>For models:</b>	GSM-anlikerXL-STANDARD, GSM-anlikerXL-STAR, GSM-FIVE-STANDARD, GSM-FIVE-STAR, GSM-Quattro-PROFI, GSM-Quattro-STANDARD		

## washers

## spring rings



1

<b>Part No.</b>	560122	<b>Ref. No.</b>	814.10039
<b>description</b>	lock washer ID $\varnothing$ 5.2mm ED $\varnothing$ 9mm SS DIN127 Qty 20 pcs for thread M5		
<b>For models:</b>	GSM-FIVE-STANDARD, GSM-FIVE-STAR, GSM-Quattro-PROFI, GSM-Quattro-STANDARD		



1

<b>Part No.</b>	560124	<b>Ref. No.</b>	814.10059
<b>description</b>	lock washer ID $\varnothing$ 8.3mm ED $\varnothing$ 15mm SS DIN127 Qty 20 pcs for thread M8		
<b>For models:</b>	GSM-FIVE-STANDARD, GSM-FIVE-STAR, GSM-Quattro-PROFI, GSM-Quattro-STANDARD		





## washers

## DIN 125A



1

<b>Part No.</b>	560111	<b>Ref. No.</b>	812.60032
<b>description</b>	plain washer ID $\varnothing$ 4.3mm ED $\varnothing$ 9mm thickness 0.8mm SS Qty 20 pcs DIN 125A for thread M4		
<b>For models:</b>	GSM-FIVE-STANDARD, GSM-FIVE-STAR, GSM-Quattro-PROFI, GSM-Quattro-STANDARD		



1

<b>Part No.</b>	560112	<b>Ref. No.</b>	812.10032
<b>description</b>	plain washer ID $\varnothing$ 5.3mm ED $\varnothing$ 10mm thickness 1mm SS Qty 20 pcs DIN 125A for thread M5		
<b>For models:</b>	GSM-anlikerXL-STANDARD, GSM-anlikerXL-STAR, GSM-FIVE-STANDARD, GSM-FIVE-STAR, GSM-Quattro-PROFI, GSM-Quattro-STANDARD		



1

<b>Part No.</b>	560114	<b>Ref. No.</b>	812.10052
<b>description</b>	plain washer ID $\varnothing$ 8.4mm ED $\varnothing$ 16mm thickness 1.6mm SS Qty 20 pcs DIN 125A for thread M8		
<b>For models:</b>	GSM-anlikerXL-STANDARD, GSM-anlikerXL-STAR, GSM-FIVE-STANDARD, GSM-FIVE-STAR		

## adjusting washer (DIN 988)



1

<b>Part No.</b>	560466	<b>Ref. No.</b>	812.50960
<b>description</b>	adjusting washer ID $\varnothing$ 37mm ED $\varnothing$ 47mm thickness 0.1mm steel Qty 1 pcs DIN 988		
<b>For models:</b>	GSM-FIVE-STANDARD, GSM-FIVE-STAR		

## tooth lock washers

## DIN 6798A



1

<b>Part No.</b>	560125	<b>Ref. No.</b>	814.20022
<b>description</b>	tooth lock washer ID $\varnothing$ 4.2mm ED $\varnothing$ 8mm SS DIN/ISO DIN 6798A Qty 20 pcs for thread M4		
<b>For models:</b>	GSM-FIVE-STANDARD, GSM-FIVE-STAR, GSM-Quattro-PROFI, GSM-Quattro-STANDARD		



1

<b>Part No.</b>	560128	<b>Ref. No.</b>	814.20052
<b>description</b>	tooth lock washer ID $\varnothing$ 8.3mm ED $\varnothing$ 15mm SS DIN/ISO DIN 6798A Qty 20 pcs for thread M8		
<b>For models:</b>	GSM-FIVE-STANDARD, GSM-FIVE-STAR, GSM-Quattro-PROFI, GSM-Quattro-STANDARD		

## fasteners

## retaining rings

## DIN 471



1

<b>Part No.</b>	519248	<b>Ref. No.</b>	815.20082
<b>description</b>	retaining ring shaft $\varnothing$ 10mm thickness 1mm SS DIN 471		
<b>For models:</b>	GSM-FIVE-STANDARD, GSM-FIVE-STAR, GSM-Quattro-PROFI, GSM-Quattro-STANDARD		

## DIN 472



1

<b>Part No.</b>	523102	<b>Ref. No.</b>	815.10314
<b>description</b>	retaining ring bore $\varnothing$ 47mm thickness 1.8mm steel DIN 472		
<b>For models:</b>	GSM-FIVE-STANDARD, GSM-FIVE-STAR		

## DIN 6799



1

<b>Part No.</b>	529268	<b>Ref. No.</b>	815.30112
<b>description</b>	retaining ring E D1 $\varnothing$ 9mm D2 $\varnothing$ 18mm stainless steel DIN 6799 thickness 1.1mm for shaft $\varnothing$ 10-14mm		
<b>For models:</b>	GSM-FIVE-STAR		

## consumables

## fuses

## fine fuses



1

<b>Part No.</b>	358509	<b>Ref. No.</b>	710.02007
<b>description</b>	fine fuse size $\varnothing$ 5x20mm 0.05A slow-acting rated 250V Qty 1 pcs		
<b>For models:</b>	GSM-anlikerXL-STANDARD, GSM-anlikerXL-STAR, GSM-FIVE-STANDARD, GSM-FIVE-STAR		

**GASTRO**PARTS.COM

