



GASTROPARTS

Project

[EN] Equipment

[DE] Geräte

[ES] Aparatos

[FR] Équipement

[IT] Attrezzature

[PL] Urządzenia

[RU] Оборудование

✉ gastroparts@gastroparts.com

☎ tel. +48 56 657 00 66

📘 fb.com/gastroparts.global

GASTROPARTS.COM





heating elements

heating plates

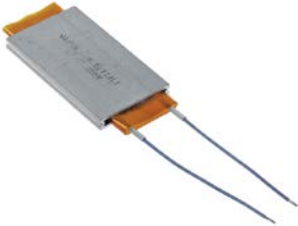



			
1			
Part No.	417568	Ref. No.	PTC01 PTC02
description	PTC element 800W 220V heating circuits 1 L 75mm W 40mm cable length 100mm heating element		
For models:	35E, 35P, 35PS, 35S, 35T, 35TS, 40E, 40P, 40PS, 40S, 40T, 40TS, 50E, 50P, 50PS, 50S, 50T, 50TS		



contact heaters



			
1			
Part No.	419178	Ref. No.	RPA01 RPA01 Pos. 27/A
description	hot plate 1500W 230V heating circuits 1 Lmm Wmm Hmm ø 110mm		
For models:	35E, 35P, 35PS, 35S, 35T, 35TS, 40E, 40P, 40PS, 40S, 40T, 40TS, 50E, 50P, 50PS, 50S, 50T, 50TS, 80E, 80P, 80PS, 80S, 80T, 80TS		

immersion heating elements

3 hole flange ø47.5mm

			
1			
Part No.	418900	Ref. No.	30640
description	heating element 4000W 230V mounting ø 47.5mm heating circuits 3 L 275mm W 32mm H 35mm number of thermostat sleeves 1 thermostat sleeves ø 7mm length thermostat sleeves 230mm thermostat sleeve eccentric, non clinging tube ø 8.4mm hole distance 63mm hole ø 8mm connection M4 3 hole flange immersion heater		
For models:	35E, 35P, 35PS, 35S, 35T, 35TS, 40E, 40P, 40PS, 40S, 40T, 40TS, 50E, 50P, 50PS, 50S, 50T, 50TS, 80E, 80P, 80PS, 80S, 80T, 80TS, E50, P350, P350S, P400, P500, S100, S50, S80, T1200, T150, T155, T255, T50, T80		
accessories for	418900		
	Part No.	Ref. No.	—
	510408		
	O-ring EPDM thickness 5.34mm ID ø 47mm Qty 1 pcs		
	Part No.	Ref. No.	—
	510562		
	O-ring silicone thickness 5.34mm ID ø 47mm Qty 1 pcs		
	Part No.	Ref. No.	—
	521103		
	nut thread M4 H 3mm WS 7 brass Qty 20 pcs		
	Part No.	Ref. No.	—
	521104		
	washer ID ø 4.3mm ED ø 8mm thickness 0.5mm brass Qty 20 pcs for thread M4		

accessories for	418900		
	Part No.	Ref. No.	—
	560111		
	plain washer ID ø 4.3mm ED ø 9mm thickness 0.8mm SS Qty 20 pcs DIN 125A for thread M4		
	Part No.	Ref. No.	—
	560131		
	hexagonal nut thread M4 H 3.2mm WS 7 SS DIN/ISO DIN 934 / ISO 4032/8673 Qty 20 pcs		

			
1			
Part No.	419001	Ref. No.	50640
description	heating element 6000W 230/400V mounting ø 47.5mm heating circuits 3 L 285mm W 33mm H 32mm number of thermostat sleeves 1 thermostat sleeves ø 7mm length thermostat sleeves 230mm thermostat sleeve eccentric, non clinging tube ø 8mm connection M4		
For models:	50E, 50P, 50PS, 50S, 50T, 50TS, 80E, 80P, 80PS, 80S, 80T, 80TS, E50, P500, S100, S50, S80, T1200, T150, T155, T255, T50, T80		
accessories for	419001		
	Part No.	Ref. No.	—
	510409		
	O-ring EPDM thickness 5.34mm ID ø 56.52mm Qty 1 pcs		

			
1			
Part No.	419000	Ref. No.	50644
description	heating element 8000W 230/400V mounting ø 47.5mm heating circuits 3 L 380mm W 33mm H 32mm number of thermostat sleeves 1 thermostat sleeves ø 7mm length thermostat sleeves 230mm thermostat sleeve eccentric, non clinging tube ø 8mm connection M4 immersion heater		
For models:	E50, P500, S100, S50, S80, T150, T155, T255, T50, T80		



			
1			
Part No.	418899	Ref. No.	60640N
description	heating element 3000W 230V mounting ø 47.5mm heating circuits 1 L 265mm W 36mm H 23mm number of thermostat sleeves 1 thermostat sleeves ø 7mm length thermostat sleeves 230mm thermostat sleeve eccentric, non clinging tube ø 6.5mm connection male faston 6.3mm		
For models:	35E, 35P, 35PS, 35S, 35T, 35TS, 40E, 40P, 40PS, 40S, 40T, 40TS, 50E, 50P, 50PS, 50S, 50T, 50TS, E35, E40, E50, G35, G40, G50, S35, S40, S50, T35, T35S, T40, T50, T80		
spare parts for	418899		
	Part No.	Ref. No.	—
	510408		
	O-ring EPDM thickness 5.34mm ID ø 47mm Qty 1 pcs		



Table continues overleaf



accessories for	418899			
	Part No.	510562	Ref. No.	—
	O-ring silicone thickness 5.34mm ID ø 47mm Qty 1 pcs			

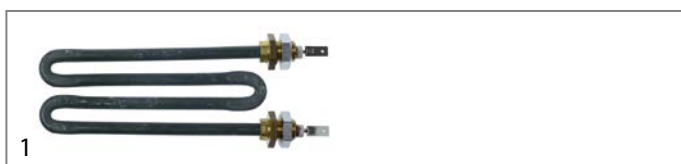

Part No.	418901	Ref. No.	60645
description	heating element 1500W 230V heating circuits 1 L 150mm W 55mm thread M14x1 mounting distance 46mm tube ø 8.5mm immersion heater connection male faston 6.3mm		
For models:	E50, G50, S100, S35, S40, S50, S80, T35, T35S, T40, T50, T80		

spare parts for	418901			
	Part No.	530315	Ref. No.	18030
	O-ring silicone thickness 1.78mm ID ø 14mm Qty 1 pcs			
	Part No.	550261	Ref. No.	—
	nut thread M14x1 H 4mm WS 19 SS Qty 1 pcs			

thermostats

bi-metal thermostats

safety bi-metal thermostats

 1	Part No.	390684	Ref. No.	30517
description	bi-metal safety thermostat hole distance 24mm switch-off temp. 100°C 1NC 1-pole 10A connection F6.3 2 hole fixing			
For models:	35E, 35P, 35PS, 35S, 35T, 35TS, 40E, 40P, 40PS, 40S, 40T, 40TS, 50E, 50P, 50PS, 50S, 50T, 50TS, 80E, 80P, 80PS, 80S, 80T, 80TS, E35, E40, E50, G35, G40, G50, P350, P350S, P400, P500, S100, S35, S40, S50, S80, T150, T155, T255, T35, T35S, T40, T50, T80			

bi-metal thermostats

 1	Part No.	390680	Ref. No.	30518
description	bi-metal thermostat hole distance 23.8mm switch-off temp. 65°C 1NC 1-pole 16A connection F6.3 2 hole fixing			
For models:	35E, 35P, 35PS, 35S, 35T, 35TS, 40E, 40P, 40PS, 40S, 40T, 40TS, 50E, 50P, 50PS, 50S, 50T, 50TS, 80E, 80P, 80PS, 80S, 80T, 80TS, E35, E40, E50, G35, G40, G50, P350, P350S, P400, P500, S35, S40, S50, S80, T35, T35S, T40, T50, T80			

 1	Part No.	390705	Ref. No.	30519
description	bi-metal thermostat hole distance 23.8mm switch-off temp. 80°C 1NC 1-pole 16A connection F6.3 2 hole fixing			
For models:	35E, 35P, 35PS, 35S, 35T, 35TS, 40E, 40P, 40PS, 40S, 40T, 40TS, 50E, 50P, 50PS, 50S, 50T, 50TS, 80E, 80P, 80PS, 80S, 80T, 80TS, E35, E40, G35, G40, G50			

control and safety thermostats

IMIT / TEMPOMATIC / AR THERMO

control thermostats

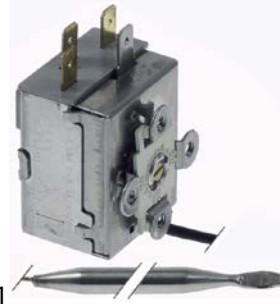

 1	Part No.	375427	Ref. No.	30510 30514
description	thermostat t.max. 90°C temperature range 0-90°C 1-pole 1CO 15A probe ø 6.5mm probe L 73mm capillary pipe 1500mm capillary pipe isolated 1440mm gland nut shaft ømm shaft Lmm shaft position rotation 270° probe material SS			
For models:	35E, 35P, 35PS, 35S, 35T, 35TS, 40E, 40P, 40PS, 40S, 40T, 40TS, 50E, 50P, 50PS, 50S, 50T, 50TS, 80E, 80P, 80PS, 80S, 80T, 80TS, E50, G50, P350, P350S, P400, P500, S100, S35, S40, S50, S80, T1200, T150, T155, T255, T35, T35S, T40, T50, T80			

switches and momentary switches

rocker/momentary rocker switches

30x22mm

labelled

 1	Part No.	300125	Ref. No.	30410
description	rocker switch mounting measurements 30x22mm green 2NO 230V 16A 0-I connection male faston 6.3mm ambient temperature max. 125/55°C protection IP65 with cover cap			
For models:	G35, G40, G50			
accessories for	300125			
	Part No.	301036	Ref. No.	—
	protective cover internal size 30x22mm for rocker switch mounting measurementsmm			





push/momentary push switches

20.6x16.4mm



1			
Part No.	347806	Ref. No.	TSTE02
description	momentary push switch mounting ø 20.6x16.4mm black 1CO 250V 16A connection male faston 6.3mm START ambient temperature max. 150°C protection IP40		
For models:	35E, 35P, 35PS, 35S, 35T, 35TS, 40E, 40P, 40PS, 40S, 40T, 40TS, 50E, 50P, 50PS, 50S, 50T, 50TS, 80E, 80P, 80PS, 80S, 80T, 80TS		
spare parts for	347806		
	Part No.	345627	Ref. No. —
element holder mounting measurements 20.6x16.4mm black arched for push buttons 13x17mm			



1			
Part No.	347805	Ref. No.	TSTE01
description	push switch mounting ø 20.6x16.4mm red 2NO 250V 16A connection male faston 6.3mm ON-OFF ambient temperature max. 150°C protection IP40		
For models:	35E, 35P, 35PS, 35S, 35T, 35TS, 40E, 40P, 40PS, 40S, 40T, 40TS, 50E, 50P, 50PS, 50S, 50T, 50TS, 80E, 80P, 80PS, 80S, 80T, 80TS		
spare parts for	347805		
	Part No.	345627	Ref. No. —
element holder mounting measurements 20.6x16.4mm black arched for push buttons 13x17mm			
	Part No.	345720	Ref. No. —
switch 2NO 250V 16A connection male faston 6.3mm			

28.5x28.5mm



1			
Part No.	347724	Ref. No.	30425R
description	push switch mounting measurements 28.5x28.5mm green 1CO 250V 16A connection male faston 6.3mm		
For models:	S100, S80, T150, T155, T255		



1			
Part No.	347176	Ref. No.	30423
description	push switch mounting measurements 28.5x28.5mm red/green 2NO 250V 16A connection male faston 6.3mm ambient temperature max. 150°C protection IP40 with indicator		
For models:	P350, P350S, P400, P500, S100, S35, S40, S50, S80, T150, T155, T255, T35, T35S, T40, T50, T80		



1			
Part No.	347613	Ref. No.	30421
description	momentary push switch mounting measurements 28.5x28.5mm blue 1CO 250V 16A drain pump connection male faston 6.3mm ambient temperature max. 150°C protection IP40		
For models:	P350, P400, P500		



1			
Part No.	347855	Ref. No.	30424
description	momentary push switch mounting measurements 28.5x28.5mm blue 2CO 250V 16A drain pump connection male faston 6.3mm ambient temperature max. 125°C protection IP40		
For models:	P350, P350S, P400, P500, T150, T155, T255		



1			
Part No.	347177	Ref. No.	30422
description	momentary push switch mounting measurements 28.5x28.5mm grey 1CO 250V 16A START connection male faston 6.3mm ambient temperature max. 150°C protection IP40		
For models:	P350, P350S, P400, P500, S100, S35, S40, S50, S80, T1200, T150, T155, T255, T35, T35S, T40, T50, T80		

34.1x23.1mm



1			
Part No.	347311	Ref. No.	30422R
description	momentary push switch mounting measurements 34.1x23.1mm yellow 1CO 250V 16A START connection male faston 6.3mm ambient temperature max. 85°C protection IP40		
For models:	E35, E40, E50		



1			
Part No.	347312	Ref. No.	30423R
description	push switch mounting measurements 34.1x23.1mm red 2NO 250V 16A connection male faston 6.3mm 0-1 protection IP40 ambient temperature max. 85°C		
For models:	E35, E40, E50		



microswitches

lever actuated



1

Part No.	345107	Ref. No.	30610
description	microswitch with lever 250V 16A 1CO connection male faston 6.3mm L 98mm ambient temperature max. 125°C mounting distance 22mm actuating force: 30g lever length 90mm		
For models:	35E, 35P, 35PS, 35S, 35T, 35TS, 40E, 40P, 40PS, 40S, 40T, 40TS, 50E, 50P, 50PS, 50S, 50T, 50TS, 80E, 80P, 80PS, 80S, 80T, 80TS, E35, E40, E50, P350, P350S, P400, P500, S100, S35, S40, S50, S80, T1200, T35, T35S, T40, T50, T80		



1

Part No.	347314	Ref. No.	30431
description	indicator light mounting measurements 34.1x23.1mm red 230V temperature connection male faston 6.3mm		
For models:	E35, E40		

lamps

indicator lights

indicator lights (complete)

ø 6mm



1

Part No.	345960	Ref. No.	30435
description	indicator light ø 6mm 230V green		
For models:	P350, P350S, P400, P500, S100, S35, S40, S50, S80, T1200, T150, T155, T255, T35, T35S, T40, T50, T80		

30x22mm



1

Part No.	345985	Ref. No.	30430	
description	indicator light mounting measurements 30x22mm 230V green			
For models:	G35, G40, G50			
accessories for	345985			
	Part No.	301036	Ref. No.	—
	protective cover internal size 30x22mm for rocker switch mounting measurementsmm			

34.1x23.1mm



1

Part No.	347313	Ref. No.	30432
description	indicator light mounting measurements 34.1x23.1mm green 230V temperature connection male faston 6.3mm		
For models:	E50		

timers

programme timers



1

Part No.	360459	Ref. No.	30450
description	timer CDC 11805M engines 1 chambers 5 operation time 120s 230V shaft ømm shaft Lmm motor type M48R ATS adjusting spanner inclusive		
For models:	E35, E40, E50, S35, S40, S50, S80, T150, T35, T35S, T40, T50, T80		



1

Part No.	360563	Ref. No.	PRGM01
description	timer CDC 11806M engines 1 chambers 6 operation time 120s 230V shaft ømm shaft Lmm manuf. no. 11806M1 motor type M48R ATS voltage AC		
For models:	35E, 35S, 35T, 35TS, 40E, 40S, 40T, 40TS, 50E, 50S, 50T, 50TS, 80E, 80S, 80T, 80TS		



1

Part No.	360538	Ref. No.	30455
description	timer CDC 4906DV engines 2 chambers 6 230V 50/60Hz manuf. no. 4906DV0COE000.0000 motor type M48R ATS voltage AC run-time 7.2/240s		
For models:	S100, T155, T255		

1

Part No.	360564	Ref. No.	50460
description	timer CDC 7803 engines 1 chambers 3 operation time 225s 230V shaft ømm shaft Lmm motor type M37RN type 7803F1 / 50460		
For models:	P500		

contactors

LOVATO

power contactors



1

Part No.	380705	Ref. No.	30520	
description	power contactor resistive load 20A 230VAC (AC3/400V) 9A/4kW main contacts 3NO auxiliary contacts 1NO connection screw connection type 11BG0910A230			
For models:	G35, G40, G50, P350, P350S, P400, P500, S100, S80, T1200, T150, T155, T255			
accessories for	380705			
	Part No.	380057	Ref. No.	—
	auxiliary contact contacts 1NO/1NC AC1 10A for contactors BG series connection screw type BGX1011			

ALLEN BRADLEY

power contactors



1

Part No.	380523	Ref. No.	30525
description	power contactor resistive load 32A 230VAC (AC3/400V) 9A/4kW main contacts 3NO auxiliary contacts 1NO connection screw connection type 100-C09KF10		
For models:	80E, 80P, 80PS, 80S, 80T, 80TS, E50, S50, T150, T155, T255, T50, T80		

relays

time relays

time relays



1

Part No.	381157	Ref. No.	30470
description	time relay FINDER TF24 time range 0.1-60 s 115-230VAC 2CO connection plug-in connection round 8-pole with socket		
For models:	P350, P350S, P400, P500		

electronics

PCBs

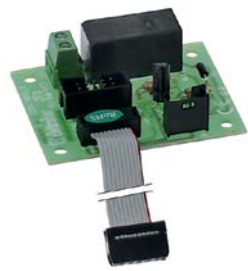



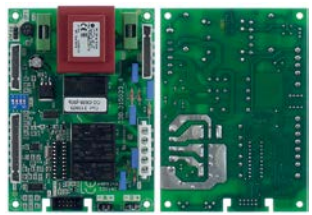

1

Part No.	401049	Ref. No.	CT215022
description	PCB dishwasher LP10/20/30		



1

Part No.	400899	Ref. No.	CT215023	
description	power PCB dishwasher LP10/20/30 without EPROM			
accessories for	400899			
	Part No.	400761	Ref. No.	—
	plug connector 5-pole			
	Part No.	400900	Ref. No.	—
	EPROM CODE 225029-3			
	Part No.	401558	Ref. No.	—
	EPROM CODE 81000-1			
	Part No.	403241	Ref. No.	—
	EPROM type U61E for dishwasher CODE 81001-3			
	Part No.	550048	Ref. No.	—
	female bullet			



solenoid valves

solenoid valves (water)

ELBI

straight



1

Part No.	373017	Ref. No.	30600
description	solenoid valve single straight 230VAC inlet 3/4" outlet 11.5mm DN10 ELBI		
For models:	35E, 35P, 35PS, 35S, 35T, 35TS, 40E, 40P, 40PS, 40S, 40T, 40TS, 50E, 50P, 50PS, 50S, 50T, 50TS, 80E, 80P, 80PS, 80S, 80T, 80TS, E35, E40, E50, G35, G40, G50, P350, P350S, P400, P500, S100, S35, S40, S50, S80, T1200, T150, T155, T255, T35, T35S, T40, T50, T80		
spare parts for	373017		
	Part No.	370467	Ref. No. —
	solenoid valve filter suitable for ELBI		

pressure switches

for warewashing

ø 58mm with male faston 6.3mm

with connection horizontal



1

Part No.	541647	Ref. No.	PRS09
description	pressure control pressure range 115/85mbar connection 6mm ø 58mm pressure connection ø 6mm		



1

Part No.	541103	Ref. No.	PRS04
description	pressure control pressure range 170/140mbar connection 6mm ø 58mm pressure connection horizontal warewashing		
For models:	35E, 35P, 35PS, 35S, 35T, 35TS, 40E, 40P, 40PS, 40S, 40T, 40TS		



1

Part No.	541778	Ref. No.	PRS02
description	pressure control pressure range 208/178mbar connection 6mm ø 58mm pressure connection horizontal warewashing pressure connection ø 6mm		
For models:	50E, 50P, 50PS, 50S, 50T, 50TS, 80E, 80P, 80PS, 80S, 80T, 80TS		



1

Part No.	541905	Ref. No.	PRS06
description	pressure control pressure range 65/30mbar connection 6mm ø 58mm pressure connection horizontal warewashing		



1

Part No.	541333	Ref. No.	30530
description	pressure control pressure range 65/30mbar connection male faston 6.3mm ø 58mm pressure connection horizontal warewashing pressure connection ø 6mm		
For models:	E35, E40, E50, G35, G40, G50, P350, P350S, P400, P500, S100, S35, S40, S50, S80, T1200, T150, T155, T255, T35, T35S, T40, T50, T80		



pumps

wash and rinse pumps

LGB







1

Part No.	500460	Ref. No.	60650
description	pump inlet ø 28mm outlet ø 26mm type ZF119DX 230V 50Hz 1 phase 0.28kW 0.38HP L 180mm rotation direction left capacitor 5µF LGB with capacitor		
For models:	E35, G35, S35		
spare parts for	500460		
	Part No.	510694	Ref. No. —
	mechanical shaft seal for shaft ø 13mm height counter ring 8mm ID ø 11.5mm H 16mm mounting ø 24/26mm int. ø 1 14mm		



1

Part No.	500461	Ref. No.	50650
description	pump inlet ø 32mm outlet ø 32mm type ZF210SX 230V 50Hz 1 phase 0.6kW 0.8HP L 180mm capacitor 12.5µF LGB		
For models:	80E, 80P, 80PS, 80S, 80T, 80TS, E50, G50, P500, S100, S50, S80, T150, T155, T255, T50		
spare parts for	500461		
	Part No.	502267	Ref. No. —
	pump cover		
	Part No.	510702	Ref. No. 500590
	mechanical shaft seal height counter ring 5.5mm ID ø 12mm		
	Part No.	521042	Ref. No. 500570
	impellor ø 103mm H 14mm pump type ZF210SX thread M10L		

spare parts for	500461		
	Part No.	532719	Ref. No. —
	O-ring EPDM thickness 2.62mm ID ø 126.67mm Qty 1 pcs		
accessories for	500461		
	Part No.	365014	Ref. No. 50645
	operating capacitor capacity 12.5µF 450V tolerance 5%Hz ambient temperature max. -25 to +85°C ø 35mm L 70mm M8 plastic connection male faston 6.3mm 45S.C3DS.12.5 protection		

drain pumps

GRE



1

Part No.	499222	Ref. No.	30660
description	drain pump inlet ø 30mm outlet ø 22mm 34W 230V 50Hz GRE		
For models:	P350, P350S, P400, P500		



1

Part No.	499221	Ref. No.	PSCAR01
description	drain pump inlet ø 30mm outlet ø 30mm 33W 230V 50Hz GRE		
For models:	35E, 35P, 35PS, 35S, 35T, 35TS, 40E, 40P, 40PS, 40S, 40T, 40TS, 50E, 50P, 50PS, 50S, 50T, 50TS, 80E, 80P, 80PS, 80S, 80T, 80TS		

booster pumps II

accessories



1

Part No.	365017	Ref. No.	30645
description	operating capacitor capacity 5µF 450V tolerance 5% 50/60Hz ambient temperature max. -25 to +85°C ø 28mm L 54mm M8 plastic connection male faston 6.3mm 16.10.08 protection		
For models:	E35, G35, P350, P400, P500, S35		



condensators & interference suppression filters

operating capacitors

plastic



1			
Part No.	365014	Ref. No.	50645
description	operating capacitor capacity 12.5µF 450V tolerance 5%Hz ambient temperature max. -25 to +85°C ø 35mm L 70mm M8 plastic connection male faston 6.3mm 45S.C3DS.12.5 protection		
For models:	80E, 80P, 80PS, 80S, 80T, 80TS, E50, G50, P500, S100, S50, S80, T150, T155, T255, T50, T80		



1			
Part No.	365017	Ref. No.	30645
description	operating capacitor capacity 5µF 450V tolerance 5% 50/60Hz ambient temperature max. -25 to +85°C ø 28mm L 54mm M8 plastic connection male faston 6.3mm 16.10.08 protection		
For models:	E35, G35, P350, P400, P500, S35		

equipment-specific units

for dishwashers

boilers

boilers for dishwashers



1			
Part No.	524943	Ref. No.	150930A
description	boiler ø 190mm L 430mm		



1			
Part No.	524944	Ref. No.	150930
description	boiler ø 190mm L 430mm		
For models:	T150, T155, T255		

air traps

air traps



1			
Part No.	511449	Ref. No.	20100
description	air trap ø 39mm H 90mm thread M8 hose ø 6mm plastic		
For models:	E35, E40, E50, G35, G40, G50, P350, P350S, P400, P500, S100, S35, S40, S50, S80, T1200, T150, T155, T255, T35, T35S, T40, T50, T80		

backflow preventers

non-return valves



1			
Part No.	507567	Ref. No.	30603
description	non-return valve thread 3/4" L 61mm		
For models:	35E, 35P, 35PS, 35S, 35T, 35TS, 40E, 40P, 40PS, 40S, 40T, 40TS, 50E, 50P, 50PS, 50S, 50T, 50TS, 80E, 80P, 80PS, 80S, 80T, 80TS, E35, E40, E50, G35, G40, G50, P350, P350S, P400, P500, S100, S35, S40, S50, S80, T150, T155, T35, T35S, T40, T50, T80		

door mechanics

miscellaneous



1			
Part No.	524945	Ref. No.	17910
description	threaded bush for hinge ø 10mm L 14mm thread M6		
For models:	E35, E40, E50, S100, S35, S40, S50, S80		

washing and rinsing systems





1			
Part No.	524939	Ref. No.	20017
description	nut for wash arm support ø 56mm ID ø 29mm H 23.5mm		
For models:	35E, 35P, 35PS, 35S, 35T, 35TS, 40E, 40P, 40PS, 40S, 40T, 40TS, 50E, 50P, 50PS, 50S, 50T, 50TS, 80E, 80P, 80PS, 80S, 80T, 80TS, E35, E40, E50, P350, P350S, P400, P500, S100, S35, S40, S50, S80, T150, T155, T35, T35S, T40, T50, T80		



			
1			
Part No.	524938	Ref. No.	20016
description	sealing ring for wash arm support plastic ø 42mm ID ø 37mm thickness 2.2mm		
For models:	35E, 35P, 35PS, 35S, 35T, 35TS, 40E, 40P, 40PS, 40S, 40T, 40TS, 50E, 50P, 50PS, 50S, 50T, 50TS, 80E, 80P, 80PS, 80S, 80T, 80TS, E35, E40, E50, P350, P350S, P400, P500, S100, S35, S40, S50, S80, T150, T155, T35, T35S, T40, T50, T80		

			
1			
Part No.	524940	Ref. No.	20135P
description	sealing ring for wash arm support plastic ø 68mm ID ø 39mm thickness 9mm		
For models:	35E, 35P, 35PS, 35S, 35T, 35TS, 40E, 40P, 40PS, 40S, 40T, 40TS, 50E, 50P, 50PS, 50S, 50T, 50TS, 80E, 80P, 80PS, 80S, 80T, 80TS, E35, E40, E50, P350, P350S, P400, P500, S100, S35, S40, S50, S80, T150, T155, T35, T35S, T40, T50, T80		

			
1			
Part No.	517791	Ref. No.	VGP01
description	Thumb screw ø 28mm thread M8 thread L 6.5mm		

			
1			
Part No.	507564	Ref. No.	16005
description	wash distributor mounting pos. upper ø 19mm L 75mm plastic thread 3/4" connection 19		
For models:	E50, S50		

baskets

warewashing baskets

steel wire baskets round

plate baskets

			
1			
Part No.	970848	Ref. No.	C0007
description	plate basket H 145mm seat ø 480mm plates 12 W 500 length 500		
For models:	P500		

steel wire baskets square

mix baskets

			
1			
Part No.	971001 ¹	Ref. No.	C0001
description	mix basket L 350mm W 350mm H 120mm mesh type wide-meshed		
For models:	E35, G35, P350, P350S, S35, T35, T35S		

¹wide-meshed

			
1			
Part No.	970074 ¹	Ref. No.	C0005
description	mix basket L 500mm W 500mm H 130mm mesh type close-meshed		
For models:	E50, G50, P500, S100, S50, S80, T150, T50, T80		

¹fine-meshed

			
1			
Part No.	970816	Ref. No.	C00015
description	mix basket L 550mm W 550mm H 110mm		
For models:	T155, T255		

tray baskets



			
1			
Part No.	970815	Ref. No.	C00017
description	tray rack L 550mm W 550mm H 105mm tablets 7		

plate baskets

			
1			
Part No.	970814	Ref. No.	C00018
description	plate basket L 550mm W 550mm H 125mm plates 24		



plastic baskets square

mix baskets



1			
Part No.	970900	Ref. No.	CPP3501
description	mix basket L 350mm W 350mm H 120mm mesh type wide-meshed plastic		



1			
Part No.	970901	Ref. No.	CPP3801
description	mix basket L 380mm W 380mm H 150mm mesh type wide-meshed plastic		



1			
Part No.	971078	Ref. No.	C0003
description	mix basket L 400mm W 400mm H 150mm		
For models:	E40, G40, P400, S40, T40		



1			
Part No.	970902	Ref. No.	CPP4001
description	mix basket L 400mm W 400mm H 150mm mesh type wide-meshed plastic		

accessories

cutlery inserts



1			
Part No.	971159	Ref. No.	CPTC02
description	cutlery insert L 110mm W 110mm ømm H 140mm		



1			
Part No.	971158	Ref. No.	CPTC01
description	cutlery insert Lmm Wmm ø 110mm H 110mm		

plate inserts



1			
Part No.	972036	Ref. No.	30740
description	plate insert L 290mm W 90mm H 75mm plates 12		
For models:	E35, E40, E50, G35, G40, G50, P350, P350S, P400, P500, S100, S35, S40, S50, S80, T35, T35S, T40, T50, T80		

gaskets

O-rings

EPDM



1			
Part No.	528632	Ref. No.	18025
description	O-ring EPDM thickness 3.53mm ID ø 44.04mm Qty 1 pcs		
For models:	35E, 35P, 35PS, 35S, 35T, 35TS, 40E, 40P, 40PS, 40S, 40T, 40TS, 50E, 50P, 50PS, 50S, 50T, 50TS, 80E, 80P, 80PS, 80S, 80T, 80TS, E35, E40, E50, P350, P350S, P400, P500, S100, S35, S40, S50, S80, T150, T155, T35, T35S, T40, T50, T80		

silicone



1			
Part No.	530315	Ref. No.	18030
description	O-ring silicone thickness 1.78mm ID ø 14mm Qty 1 pcs		
For models:	S100, S35, S40, S50, S80, T35, T35S, T40, T50, T80		



1			
Part No.	532684	Ref. No.	18005
description	O-ring silicone thickness 1.78mm ID ø 4.48mm Qty 1 pcs		
For models:	E35, E40, E50, P350, P350S, P400, P500, S35, S40, S50, T35, T35S, T40, T50, T80		



sealing washers

rubber gaskets



Part No.	517181	Ref. No.	19000
description	flat gasket rubber ED ø 44mm ID ø 32mm thickness 3mm Qty 1 pcs		
For models:	E35, E40, E50, G35, G40, G50, P350, P350S, P400, P500, S100, S35, S40, S50, S80, T35, T35S, T40, T50, T80		

dosing pumps

peristaltic dosing pumps

BORES

built-in version



with flow control









Part No.	361863	Ref. No.	60675
description	dosing pump BORES type P2 control 1 flow control control 2 flow control		
For models:	G35, G40, G50		

without control



Part No.	361743	Ref. No.	30683	
description	dosing pump BORES 0.4l/h 230VAC rinse aid hose ø 4x6mm hose type silicone type PB0.2P			
For models:	35E, 35P, 35PS, 35S, 35T, 35TS, 40E, 40P, 40PS, 40S, 40T, 40TS, 50E, 50P, 50PS, 50S, 50T, 50TS, 80E, 80P, 80PS, 80S, 80T, 80TS, E35, E40, E50, P350, P350S, P400, P500, S100, S35, S40, S50, S80, T150, T155, T255, T35, T35S, T40, T50, T80			
accessories for	361743			
	Part No.	361144	Ref. No.	—
	mounting set rinse aid hose type 4x6mm hose length 2m PVC/nylon hose container filter/non-return valve transparent			
	Part No.	361291	Ref. No.	—
	pump hose PROTHO/MYBO rinse aid hose ø 2x6mm hose type silicone			



Part No.	361280	Ref. No.	30673	
description	dosing pump BORES without control 1.5l/h 230VAC detergent hose ø 4x6mm hose type Santoprene type Protho built-in version CODE PD1.5			
For models:	35E, 35P, 35PS, 35S, 35T, 35TS, 40E, 40P, 40PS, 40S, 40T, 40TS, 50E, 50P, 50PS, 50S, 50T, 50TS, 80E, 80P, 80PS, 80S, 80T, 80TS, P350, P350S, P400, P500, S100, S35, S40, S50, S80, T150, T155, T255, T35, T35S, T40, T50, T80			
spare parts for	361280			
	Part No.	361232	Ref. No.	—
	roller assembly detergent hose type Santoprene pump type PROTHO/MYBO			
	Part No.	361234	Ref. No.	—
	cover pump type PROTHO/MYBO hose type			
	Part No.	361290	Ref. No.	—
	pump hose PROTHO/MYBO detergent hose ø 7x10mm hose type Santoprene			
	Part No.	361409	Ref. No.	—
	pump head pump type PROTHO/MYBO hose type Santoprene detergent hose ø 7x10mm			
accessories for	361280			
	Part No.	361142	Ref. No.	—
	mounting set detergent hose type 4x6mm hose length 2m PVC 2x hose/container filter/tank intake transparent			
	Part No.	520090	Ref. No.	—
	PVC hose ID ø 4mm ED ø 6mm L 2m thickness 1mm t.max. 60°C transparent			
	Part No.	520091	Ref. No.	—
	nylon hose ID ø 4mm ED ø 6mm L 2m thickness 1mm operating p. 10bar burst p. 50bar t.max. 100°C transparent			







SEKO

built-in version

with time control



1

Part No.	361211 ¹	Ref. No.	30680	
description	dosing pump SEKO with single time control 0.4l/h 230VAC rinse aid hose ø 4x6mm hose type D hose Sekobril suction level 1.5m type PBM built-in version dosing time 1-20s			
For models:	P350, P400, P500, T1200			
spare parts for	361211			
	Part No.	361135	Ref. No.	—
	pump hose SEKO rinse aid hose ø 3x8mm hose ø 4x6mm hose type D hose Sekobril			
	Part No.	361136	Ref. No.	—
	roller assembly for dosing pump hole ø 4.8x4mm			
accessories for	361211			
	Part No.	361144	Ref. No.	—
	mounting set rinse aid hose type 4x6mm hose length 2m PVC/nylon hose container filter/non-return valve transparent			
	Part No.	520090	Ref. No.	—
	PVC hose ID ø 4mm ED ø 6mm L 2m thickness 1mm t.max. 60°C transparent			
	Part No.	520091	Ref. No.	—
	nylon hose ID ø 4mm ED ø 6mm L 2m thickness 1mm operating p. 10bar burst p. 50bar t.max. 100°C transparent			

¹with accessories

accessories

non-return valves



1

Part No.	361898	Ref. No.	30720
description	non-return valve inlet 6mm outlet 6mm WS 14 L 48mm		

hoses

drain hoses

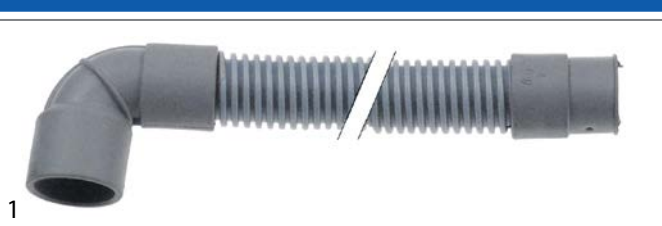

1

Part No.	530614	Ref. No.	30770 600145
description	drain hose DN21 L 1750mm straight ø inside 21mm straight ext. ø 27mm elbow ø inside 28mm elbow ext. ø 34mm outer hose ø 27mm		
For models:	35E, 35P, 35PS, 35S, 35T, 35TS, 40E, 40P, 40PS, 40S, 40T, 40TS, 50E, 50P, 50PS, 50S, 50T, 50TS, 80E, 80P, 80PS, 80S, 80T, 80TS, E35, E40, E50, G35, G40, G50, P350, P350S, P400, P500, S100, S35, S40, S50, S80, T150, T155, T255, T35, T35S, T40, T50, T80		

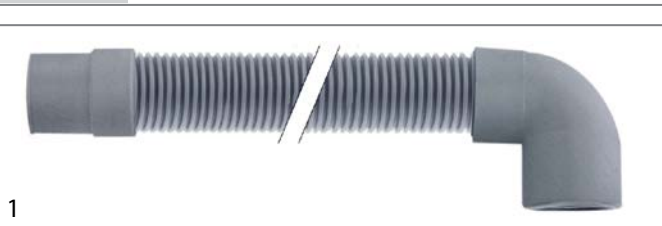

1

Part No.	530572	Ref. No.	300770
description	drain hose DN24 L 2000mm straight ø inside 24mm straight ext. ø 29mm elbow ø inside 29mm elbow ext. ø 35mm outer hose ø 29mm		

formed hoses

with branch



1

Part No.	530801	Ref. No.	120460
description	formed hose ID ø 15/50mm ED ø 25/63mm L 72mm straight with piggyback		
For models:	T1200		



water softeners

automatic softeners

spare parts



1

Part No.	530315	Ref. No.	18030
description	O-ring silicone thickness 1.78mm ID ø 14mm Qty 1 pcs		
For models:	S100, S35, S40, S50, S80, T35, T35S, T40, T50, T80		

measuring equipment

thermometers

built-in thermometers



1

Part No.	541095	Ref. No.	120500
description	thermometer mounting measurements 58x25.5mm 0 up to +120°C capillary pipe 3000mm probe ø 6.5mm probe L 20mm		
For models:	T1200, T150, T155, T255		

fastening material

nuts

hexagonal nuts

hexagonal nuts inch thread



1

Part No.	517180	Ref. No.	17060
description	nut thread 1" H 5mm WS 36 SS Qty 1 pcs		
For models:	E35, E40, E50, G35, G40, G50, P350, P350S, P400, P500, S100, S35, S40, S50, S80, T35, T35S, T40, T50, T80		

GASTROPARTS.COM

