



GASTROPARTS

LineaBlanca

- [EN]** Equipment
- [DE]** Geräte
- [ES]** Aparatos
- [FR]** Équipement
- [IT]** Attrezzature
- [PL]** Urządzenia
- [RU]** Оборудование

✉ gastroparts@gastroparts.com

☎ +48 56 657 00 66

📘 fb.com/gastroparts.global

GASTROPARTS.COM





heating elements

immersion heating elements

3 hole flange ø38.5mm

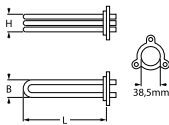
1

Part No.	416367	Ref. No.	A030019 A030019/1
description	heating element 2700W 230V mounting ø 38.5mm heating circuits 1 L 280mm W 26mm H 26mm tube ø 6mm hole distance 59mm hole ø 10mm 3 hole flange connection male faston 6.3mm immersion heater		
accessories for	416367		
		Part No.	532577 Ref. No. —
	O-ring EPDM thickness 5.34mm ID ø 40.65mm Qty 1 pcs		



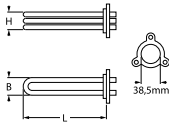

1

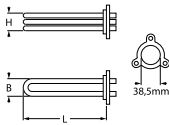
Part No.	418787	Ref. No.	A030020 A030020/1
description	heating element 3000W 230V mounting ø 38.5mm heating circuits 1 L 280mm W 25mm H 28mm tube ø 6.25mm connection male faston 6.3mm		

1

Part No.	418788	Ref. No.	A030013
description	heating element 4500W 230V mounting ø 38.5mm heating circuits 3 L 280mm W 30mm H 27mm number of thermostat sleeves 1 tube ø 6.25mm hole distance 59mm hole ø 10mm connection male faston 6.3mm		
accessories for	418788		
		Part No.	532577 Ref. No. —
	O-ring EPDM thickness 5.34mm ID ø 40.65mm Qty 1 pcs		

3 hole flange ø47.5mm





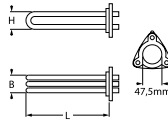

1

Part No.	419073	Ref. No.	A030017
description	heating element 6000W 230V mounting ø 47.5mm heating circuits 3 L 315mm W 33mm H 36mm thermostat sleeves ø 7mm length thermostat sleeves 280mm thermostat sleeve eccentric, non clinging tube ø 6.5mm connection male faston 6.3mm		
accessories for	419073		
		Part No.	510408 Ref. No. A040026
	O-ring EPDM thickness 5.34mm ID ø 47mm Qty 1 pcs		

1

Part No.	416241	Ref. No.	I030007
description	heating element 8000W 230V mounting ø 47.5mm heating circuits 3 L 355mm W 35mm H 35mm number of thermostat sleeves 1 thermostat sleeves ø 7.5mm length thermostat sleeves 185mm thermostat sleeve not clinging tube ø 6.3mm hole distance 64mm hole ø 8mm connection M4 3 hole flange immersion heater		
spare parts for	416241		
		Part No.	510408 Ref. No. A040026
	O-ring EPDM thickness 5.34mm ID ø 47mm Qty 1 pcs		
accessories for	416241		
		Part No.	510093 Ref. No. —
	protection cap		
		Part No.	510408 Ref. No. A040026
	O-ring EPDM thickness 5.34mm ID ø 47mm Qty 1 pcs		
		Part No.	510562 Ref. No. —
	O-ring silicone thickness 5.34mm ID ø 47mm Qty 1 pcs		



with expansion flange 70 x 18mm



1

Part No.	416357	Ref. No.	A030021
description	heating element 2000W 230V heating circuits 1 flange 70x18mm L 265mm W 65mm connection M4 tube ø 8.5mm		





			
1			
Part No.	416366	Ref. No.	A030022
description	heating element 2700W 230V heating circuits 1 flange 70x18mm L 265mm W 65mm tube ø 8.5mm connection length 32mm		
accessories for	416366		
	Part No.	510429	Ref. No. —
description	gasket L 76mm W 23mm hole distance 25mm 3 holes for heating element type DB 70 without thermostat sensor hole		
	Part No.	520238	Ref. No. —
description	flange L 80mm W 28mm hole distance 13mm 5 holes type DB 70 code L		

with round flange ø47.5mm

			
1			
Part No.	418784	Ref. No.	A030014
description	heating element 2500W 230V heating circuits 3 mounting ø 47.5mm L 345mm W 42mm H 45mm connection male faston 6.3mm tube ø 6.5mm H1 22mm H2 23mm		

			
1			
Part No.	418785	Ref. No.	A030016
description	heating element 3000W 230V heating circuits 3 mounting ø 47.5mm L 345mm W 41mm H 55mm connection male faston 6.3mm tube ø 6.5mm H1 26mm H2 29mm		

			
1			
Part No.	418783	Ref. No.	A030015
description	heating element 5000W 230V heating circuits 3 mounting ø 47.5mm L 350mm W 41mm H 55mm connection male faston 6.3mm tube ø 6.5mm H1 28mm H2 27mm		

			
1			
Part No.	418789	Ref. No.	A030018PL A030018PLF
description	heating element 2000W 230V heating circuits 1 L 325mm W 85mm H 25mm L1 65mm L2 260mm W1 50mm W2 35mm thread M12x1 mounting distance 30mm tube ø 6.25mm connection length 25mm 2 hole fixing connection male faston 6.3mm immersion heater		

accessories

hexagonal nuts

			
1			
Part No.	560131	Ref. No.	A060001
description	hexagonal nut thread M4 H 3.2mm WS 7 SS DIN/ISO DIN 934 / ISO 4032/8673 Qty 20 pcs		

			
1			
Part No.	560132	Ref. No.	A060050
description	hexagonal nut thread M5 H 4mm WS 8 SS DIN/ISO DIN 934 / ISO 4032/8673 Qty 20 pcs		

			
1			
Part No.	521131	Ref. No.	A030403
description	nut thread M12x1 H 3.5mm WS 17 SS Qty 1 pcs		

washers

			
1			
Part No.	560111	Ref. No.	A060163
description	plain washer ID ø 4.3mm ED ø 9mm thickness 0.8mm SS Qty 20 pcs DIN 125A for thread M4		

sealing washers

fibre gaskets

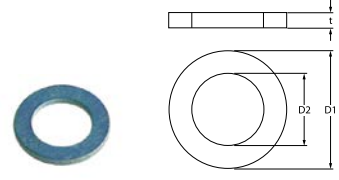
			
1			
Part No.	521110	Ref. No.	A030402
description	flat gasket fibre ED ø 20mm ID ø 13mm thickness 2mm Qty 1 pcs		

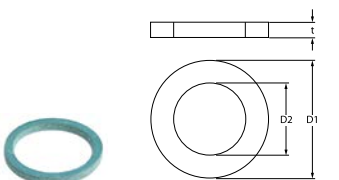
			
1			
Part No.	503106	Ref. No.	A040043
description	flat gasket fibre ED ø 32mm ID ø 26mm thickness 3mm Qty 1 pcs		



O-rings			
1			
Part No.	510408	Ref. No.	A040026
description	O-ring EPDM thickness 5.34mm ID ø 47mm Qty 1 pcs		

thermostats

bi-metal thermostats

safety bi-metal thermostats

1			
Part No.	390318	Ref. No.	A030067/1
description	bi-metal safety thermostat switch-off temp. 95°C 1-pole 2 hole fixing		

control and safety thermostats

IMIT / TEMPOMATIC / AR THERMO

control thermostats

1			
Part No.	375921	Ref. No.	A030067
description	thermostat t.max. 90°C temperature range 30-90°C 1-pole 1CO 16A probe ø 6.5mm probe L 98mm capillary pipe 1030mm capillary pipe isolated 970mm gland nut shaft ø 6x4.6mm shaft L 18mm shaft position +135° rotation 270° probe material copper 250V		

switches and momentary switches

rocker/momentary rocker switches

30x22mm			
1			
Part No.	301003	Ref. No.	A030037
description	rocker switch mounting measurements 30x22mm green 2NO 250V 16A illuminated 0-I connection male faston 6.3mm ambient temperature max. 125/55°C protection IP65		
accessories for	301003		
	Part No.	301036	Ref. No.
			—
	protective cover internal size 30x22mm for rocker switch mounting measurementsmm		

1			
Part No.	301015	Ref. No.	A030041
description	rocker switch mounting measurements 30x22mm red 2CO 250V 16A illuminated connection male faston 6.3mm ambient temperature max. 125/55°C protection IP40		

1			
Part No.	346409	Ref. No.	A030045
description	momentary rocker switch mounting measurements 30x22mm yellow 2NO 250V 10A illuminated connection male faston 6.3mm ambient temperature max. 100/55°C protection IP40		
accessories for	346409		
	Part No.	301036	Ref. No.
			—
	protective cover internal size 30x22mm for rocker switch mounting measurementsmm		

push/momentary push switches

ø25mm

1			
Part No.	345161 ¹	Ref. No.	A030049
description	push switch mounting ø 25mm green 2NO 250V 16A illuminated connection male faston 6.3mm ambient temperature max. 85°C protection IP40		

¹illuminated

1			
Part No.	345011	Ref. No.	A030049C
description	push switch mounting ø 25mm green 2NO 250V 16A illuminated connection male faston 6.3mm ambient temperature max. 85°C protection IP65		
accessories for	345011		
	Part No.	345039	Ref. No.
			—
	protective cover round ED ø 33mm external size 23mm internal size 21mm H 12mm clear mounting ø 25mm		



magnetic switches

36x13mm

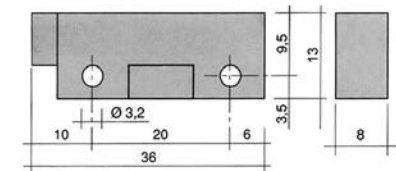

Part No.	345335	Ref. No.	A030250
description	magnetic switch L 36mm W 13mm 1NO 250V 0.04A P max. 10W connection cable length 960mm		
accessories for	345335		
	Part No.	519049	Ref. No. —
	magnet ømm L 63mm H 10.7mm W 18.8mm hole distance 52mm M2 hole ø 2mm		

accessories

magnets

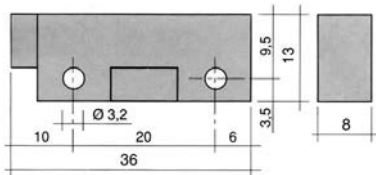

Part No.	345398	Ref. No.	A030252
description	magnet ømm L 36mm H 8mm W 13mm hole distance 20mm M3 hole ø 3mm		

lamps

indicator lights

indicator lights (complete)

ø12mm

with plug-in socket



Part No.	359041	Ref. No.	A030099
description	indicator light ø 12mm green 230V connection male faston 6.3mm temp.-resist. 120°C Qty 1 pcs		



Part No.	359043	Ref. No.	A030097
description	indicator light ø 12mm red 230V connection male faston 6.3mm temp.-resist. 120°C Qty 1 pcs		



Part No.	359042	Ref. No.	A030098
description	indicator light ø 12mm yellow 230V connection male faston 6.3mm temp.-resist. 120°C Qty 1 pcs		

ø25mm



Part No.	359204	Ref. No.	A030074
description	indicator light ø 25mm 230V green connection male faston 6.3mm temp.-resist. 85°C		
accessories for	359204		
	Part No.	345039	Ref. No. —
	protective cover round ED ø 33mm external size 23mm internal size 21mm H 12mm clear mounting ø 25mm		



Part No.	359202	Ref. No.	A030072
description	indicator light ø 25mm 230V red connection male faston 6.3mm		



Part No.	359203	Ref. No.	A030073
description	indicator light ø 25mm 230V yellow connection male faston 6.3mm		

30x22mm



Part No.	359157	Ref. No.	N/A
description	indicator light mounting measurements 30x22mm 230V green connection male faston 6.3mm temp.-resist. 125/55°C type RL2		
accessories for	359157		
	Part No.	301036	Ref. No. —
	protective cover internal size 30x22mm for rocker switch mounting measurementsmm		



			
1			
Part No.	359155	Ref. No.	A030033
description	indicator light mounting measurements 30x22mm 230V red connection male faston 6.3mm temp.-resist. 125°C type RL2		

			
1			
Part No.	346968	Ref. No.	A030035
description	indicator light mounting measurements 30x22mm 230V yellow/red connection male faston 6.3mm		

timers

programme timers

			
1			
Part No.	360433	Ref. No.	A030060
description	timer CROUZET engines 1 chambers 2 operation time 120s 230V shaft ø 6x4.6mm shaft L 20mm motor type 82340		

contactors

ALLEN BRADLEY

power contactors

			
1			
Part No.	380458	Ref. No.	A030043
description	power contactor resistive load 20A 230VAC (AC3/400V) 9A/4kW main contacts 3NO auxiliary contacts 1NO connection screw connection type 100-K09KF10		

			
1			
Part No.	381121	Ref. No.	A030261
description	power contactor resistive load 32A 230VAC (AC3/400V) 16A/7.5kW main contacts 3NO auxiliary contacts 1NO connection screw connection type 100-C16KF10		

			
1			
Part No.	380931	Ref. No.	A030260
description	power contactor resistive load 32A 230VAC (AC3/400V) 23A/11kW main contacts 3NO auxiliary contacts 1NO connection screw connection type 100-C23KF10		

			
1			
Part No.	380459	Ref. No.	A030042
description	power contactor resistive load 65A 230VAC (AC3/400V) 30A/15kW main contacts 3NO connection screw connection type 100-C30KF00 50/60Hz		

relays

power relays

with bracket mounting

			
1			
Part No.	380815	Ref. No.	A030059
description	power relays 230VAC 16A 2NO connection male faston 6.3mm flange dimensions 36x38x68mm		

1

Part No.	380139	Ref. No.	A030063
description	power relays FINDER 230VAC 16A 2CO connection F6.3 bracket mounting dimensions 68x38.2x35.8mm manuf. no. 62.82.8.230.0000		



1

Part No.	380687	Ref. No.	A030055
description	power relays FINDER 230VAC 30A 2NO connection F6.3 bracket mounting manuf. no. 66.82.8.230.0300		

with male contacts

female contact 4.8mm



1

Part No.	380475	Ref. No.	A030056/1	
description	power relays FINDER 220-240VAC 12A 2CO connection F4.8 raster size 10mm plug-in connection manuf. no. 56.32.8.230.0040 250V 2-pole connection 4.8mm			
accessories for	380475			
	Part No.	380476	Ref. No.	—
	relay socket dimensions 78x27x33.5mm 250V voltage AC 10A FINDER manuf. no. 96.72			

female contact 6.3mm

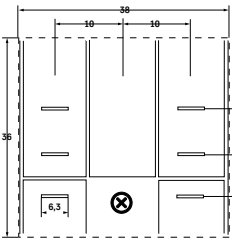
1

Part No.	380866	Ref. No.	A030063/2	
description	plug-in relay FINDER 230VAC 16A 2NO connection F6.3 plug-in connection manuf. no. 62.82.8.230.0309 250V connection 6.3mm			
accessories for	380866			
	Part No.	381039	Ref. No.	—
	adapter for DIN rail mounting suitable for FINDER relay 62 series.			

accessories



1

Part No.	380447	Ref. No.	A030057/1
description	adapter for DIN rail mounting suitable for FINDER relay 56.32 series.		

solenoid valves

solenoid valves (water)

TP



1





















Part No.	370017	Ref. No.	A020030	
description	solenoid valve single straight 230VAC inlet 3/4" outlet 11.5mm DN10 TP p max 10bar			
spare parts for	370017			
	Part No.	371013	Ref. No.	—
	solenoid coil TP 230VAC 50/60Hz			
accessories for	370017			
	Part No.	371220	Ref. No.	—
	reducer TP flow rate 3l/min red tolerance ±15%			
	Part No.	371221	Ref. No.	—
	reducer TP flow rate 5.5l/min yellow tolerance ±15%			
	Part No.	371222	Ref. No.	—
	reducer TP flow rate 6l/min grey tolerance ±15%			
	Part No.	371223	Ref. No.	—
	reducer TP flow rate 10l/min white tolerance ±15%			
	Part No.	371224	Ref. No.	—
	reducer TP flow rate 12l/min bronze tolerance ±15%			
	Part No.	371225	Ref. No.	—
	reducer TP flow rate 16l/min light brown tolerance ±15%			
	Part No.	371226	Ref. No.	—
	reducer TP flow rate 20l/min red tolerance ±15%			
	Part No.	371230	Ref. No.	—
	reducer TP flow rate 0.25l/min red tolerance ±25%			
	Part No.	371231	Ref. No.	—
	reducer TP flow rate 0.35l/min violet tolerance ±25%			

Table continues overleaf





accessories for 370017		Part No.	371232	Ref. No.	—
	reducer TP flow rate 0.5l/min orange tolerance ±25%	Part No.	371233	Ref. No.	—
	reducer TP flow rate 0.8l/min white tolerance ±25%	Part No.	371234	Ref. No.	—
	reducer TP flow rate 1l/min light blue tolerance ±25%	Part No.	371235	Ref. No.	—
	reducer TP flow rate 1.2l/min brown tolerance ±25%	Part No.	371236	Ref. No.	—
	reducer TP flow rate 1.5l/min light brown tolerance ±25%	Part No.	371237	Ref. No.	—
	reducer TP flow rate 2.5l/min yellow tolerance ±25%	Part No.	371238	Ref. No.	—
	reducer TP flow rate 3.4l/min dark green tolerance ±25%	Part No.	371239	Ref. No.	—
	reducer TP flow rate 5l/min black tolerance ±25%	Part No.	371240	Ref. No.	—
	reducer TP flow rate 8l/min blue tolerance ±20%				

	1	Part No.	370409	Ref. No.	A029020
description solenoid valve single straight 230VAC inlet 3/4" outlet 11.5mm output 3.4l/min t.max. 90°C TP plastic flow regulating valve outlet green flow regulating valve inlet white					

metal					
PARKER					
spare parts and accessories					
solenoid coils					
	1	Part No.	371033	Ref. No.	A039001 A039820
description solenoid coil PARKER 230VAC 9VA coil type YB09 with cable seat ø 14mm					

solenoid valves with reducers

	1	Part No.	370410	Ref. No.	A029024
description solenoid valve double straight 230VAC inlet 3/4" input 10l/min t.max. 90°C TP plastic outlet 11.5mm output A 3.4l/min output B 3.4l/min					

	1	Part No.	370411	Ref. No.	A029021
description solenoid valve double straight 230VAC inlet 3/4" t.max. 90°C TP plastic flow regulating valve inlet white outlet 11.5mm output B 3.4l/min flow regulating valve outlet B green output A w/t membrane (constantly open)					

pressure switches
for warewashing

73x43mm with coded plug					
	1	Part No.	541955	Ref. No.	A030062
description pressure control pressure range 75/50mbar connection 6mm size 73x43mm pressure connection ø 5.5mm					



compressors

L'UNITE HERMETIQUE / TECUMSEH

R404A

HMBP monophasé

High/Medium evaporation temperature above -20/-15 °C



1

Part No.	605025	Ref. No.	A029058
description	compressor coolant R404A type AE4430Z-FZ 220-240V 50Hz HMBP fully hermetic 10.2kg 1/4HP power input 427W cylinder capacity 5.7cm ³ CSIR H 186mmWW 258W 346W 441W 550W 682W 794W test method EN 12900 908W		
spare parts for	605025		
	Part No.	380061	Ref. No. —
	start relay MTRP0027-31 120/240V voltage AC 8A 1NO		

fans

refrigeration fans

refrigeration motors universal

IMPORT

multi fit fan motors



1

Part No.	601023	Ref. No.	A039204
description	fan motor 16W 230V 50-60Hz L1 45mm L2 61mm L3 92mm W 84mm cable length 500mm 1300rpm YZF16-25-18/26 5 mounting options bearing slide bearing		



1

Part No.	601020	Ref. No.	A039200
description	fan motor 5W 230V 50-60Hz L1 44mm L2 48mm L3 79mm W 84mm cable length 500mm 1300rpm YZF5-13-18/26 5 mounting options bearing slide bearing		

accessories

fan wheels

aluminium

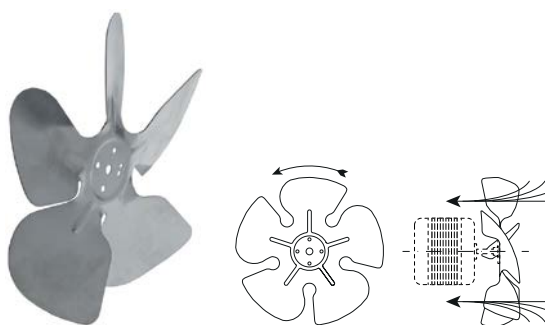

1

Part No.	601070	Ref. No.	A039211
description	fan wheel sucking ø 200mm fan wheel mounting 25.4mm blade angle 28° W 38mm aluminium		

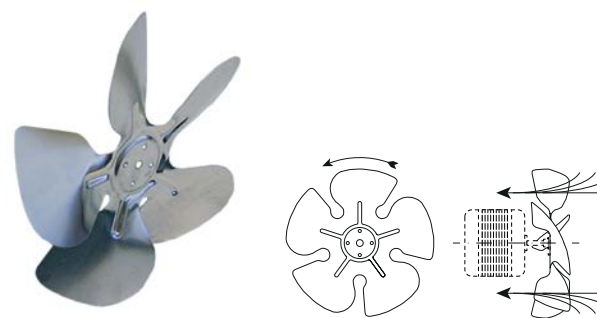

1

Part No.	601072	Ref. No.	A039210
description	fan wheel sucking ø 250mm fan wheel mounting 25.4mm blade angle 25° W 50mm aluminium		

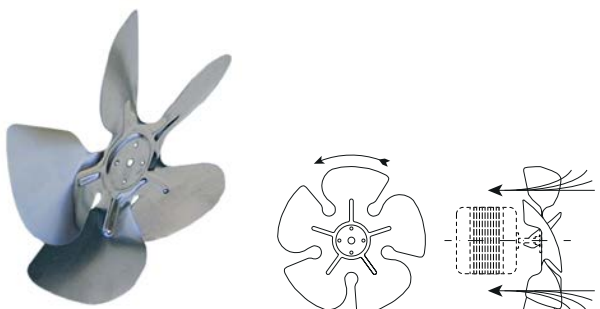
1

Part No.	601073	Ref. No.	A039212
description	fan wheel sucking ø 300mm fan wheel mounting 25.4mm blade angle 22° W 41mm aluminium		

pumps

wash and rinse pumps

FIR

pumps





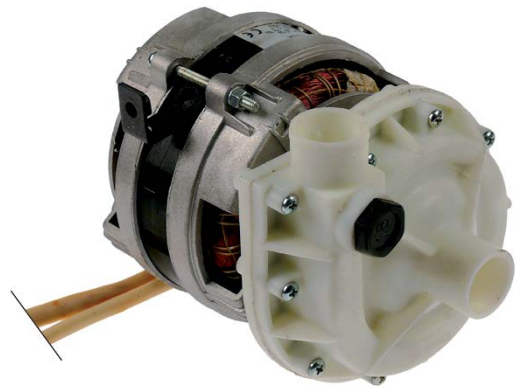

1

Part No.	500685	Ref. No.	A020006 A020006/A
description	pump inlet ø 28mm outlet ø 26mm type 2214.1403 230V 50Hz 1 phase 0.11kW 0.15HP L 197mm rotation direction right capacitor 6.3µF FIR		
spare parts for	500685		
	Part No.	365012	Ref. No. A030304
	operating capacitor capacity 6.3µF 450V tolerance 5% 50Hz ambient temperature max. -25 to +85°C ø 30mm L 61mm M8 plastic connection male faston 6.3mm protection		
	Part No.	510510	Ref. No. —
	pump cover pump type 2212/2228/2229/2211		
	Part No.	510695	Ref. No. —
	mechanical shaft seal height counter ring 5.5mm ID ø 11mm		
	Part No.	521203	Ref. No. A020909
	impellor ø 72mm H 18mm thread M7 shaft ø 11mm shaft length 32mm blades 3		
	Part No.	521703	Ref. No. A020944
	pump cover gasket EPDM thickness 2.5mm ID ø 75mm Qty 1 pcs		



1

Part No.	500686	Ref. No.	A020001 A020001/A
description	pump inlet ø 30mm outlet ø 30mm type 1252.1401 230V 50Hz 1 phase 0.19kW 0.25HP L 180mm rotation direction right capacitor 10µF FIR		
spare parts for	500686		
	Part No.	365015	Ref. No. A030300
	operating capacitor capacity 10µF 400V tolerance 5%Hz ambient temperature max. -25 to +85°C ø 35.5mm L 59mm M8 plastic connection male faston 6.3mm protection		
	Part No.	510605	Ref. No. A020910
	impellor ø 80mm H 21mm M7L		
	Part No.	510702	Ref. No. —
	mechanical shaft seal height counter ring 5.5mm ID ø 12mm		
	Part No.	521571	Ref. No. A020900
	pump cover FIR inlet ø 30mm outlet ø 30mm turn direction right ø 128mm ID ø 100mm inner height 21mm		
	Part No.	521701	Ref. No. A020941
	pump cover gasket		

booster pumps II

accessories



1

Part No.	365015	Ref. No.	A030300
description	operating capacitor capacity 10µF 400V tolerance 5%Hz ambient temperature max. -25 to +85°C ø 35.5mm L 59mm M8 plastic connection male faston 6.3mm protection		



			
1			
Part No.	365012	Ref. No.	A030304
description	operating capacitor capacity 6.3µF 450V tolerance 5% 50Hz ambient temperature max. -25 to +85°C ø 30mm L 61mm M8 plastic connection male faston 6.3mm protection		

condensators & interference suppression filters

starting capacitors

starting capacitors

			
1			
Part No.	365059	Ref. No.	A039322
description	starting capacitor 330V duty cycle 1.7% capacity 64µF		

operating capacitors

plastic

			
1			
Part No.	365015	Ref. No.	A030300
description	operating capacitor capacity 10µF 400V tolerance 5%Hz ambient temperature max. -25 to +85°C ø 35.5mm L 59mm M8 plastic connection male faston 6.3mm protection		

			
1			
Part No.	365014	Ref. No.	A030301
description	operating capacitor capacity 12.5µF 450V tolerance 5%Hz ambient temperature max. -25 to +85°C ø 35mm L 70mm M8 plastic connection male faston 6.3mm 45S.C3DS.12.5 protection		

			
1			
Part No.	365021	Ref. No.	A030305
description	operating capacitor capacity 16µF 425V tolerance 5% 50/60Hz ambient temperature max. -25 to +85°C ø 35mm L 73mm single M8 plastic connection male faston 6.3mm 416.10.99 protection		

			
1			
Part No.	365016	Ref. No.	A030303
description	operating capacitor capacity 31.5µF 400V tolerance 5%Hz ambient temperature max. -25 to +85°C ø 45mm L 95mm M8 plastic connection male faston 6.3mm protection		

			
1			
Part No.	365012	Ref. No.	A030304
description	operating capacitor capacity 6.3µF 450V tolerance 5% 50Hz ambient temperature max. -25 to +85°C ø 30mm L 61mm M8 plastic connection male faston 6.3mm protection		

electric accessories

cables

accessories

cable glands

threaded cable glands

screw connections

			
1			
Part No.	550971	Ref. No.	A030065/1
description	cable gland thread PG16 cable ø 14mm mounting ø 22.5mm Qty 1 pcs plastic WS 27		





			
1			
Part No.	550973	Ref. No.	A030065
description	cable gland thread PG21 cable ø 17mm mounting ø 28mm Qty 1 pcs plastic WS 34		

terminals

connection terminals with screw/faston connections

			
1			
Part No.	550278	Ref. No.	A030108
description	power terminal block 3-pole max. 40A max 400V connection ø6mm ² / F6.3 temp.-resist. 150°C cross section 6mm ²		

			
1			
Part No.	550349	Ref. No.	A030109
description	power terminal block 4-pole max. 40A max 400V connection ø6mm ² / F6.3 temp.-resist. 150°C cross section 6mm ²		

			
1			
Part No.	550411	Ref. No.	A030113
description	power terminal block 6-pole max. 40A max 450V connection ø6mm ² / F6.3 temp.-resist. 150°C cross section 6mm ²		

terminal boards

			
1			
Part No.	550413	Ref. No.	A030106
description	terminal board 3-pole thread M5 L 55mm W 36mm		

equipment-specific units

for ice-cube maker

doors

doors

			
1			
Part No.	695409	Ref. No.	A309007
description	door for ice-cube maker W 400mm H 250mm thickness 22mm		

			
1			
Part No.	695410	Ref. No.	A309008
description	door for ice-cube maker W 528mm H 260mm thickness 21mm		

			
1			
Part No.	695411	Ref. No.	A309009
description	door for ice-cube maker W 757mm H 260mm thickness 22mm		

curtains

accessories

holders

			
1			
Part No.	695405	Ref. No.	A709107
description	bracket for shaft		

			
1			
Part No.	695404	Ref. No.	A049052
description	curtain holder for ice maker W 340mm H 115mm		



lamellas



1

Part No.	695408	Ref. No.	A049054
-----------------	--------	-----------------	---------

description	lamella for curtain W 10mm H 120mm ø 6mm
--------------------	--



1

Part No.	695407	Ref. No.	A049053
-----------------	--------	-----------------	---------

description	lamella for curtain W 25mm H 120mm ø 6mm
--------------------	--

curtain rods



1

Part No.	695406	Ref. No.	A059053
-----------------	--------	-----------------	---------

description	curtain rod for ice-cube maker L 275mm ø 6mm
--------------------	--

pan mechanics

spare parts and accessories



1

Part No.	695394	Ref. No.	A049059
-----------------	--------	-----------------	---------

description	bracket for bearing
--------------------	---------------------



1

Part No.	695402	Ref. No.	A479050
-----------------	--------	-----------------	---------

description	breakwater for sump L 285mm
--------------------	-----------------------------



1

Part No.	695390	Ref. No.	A049061
-----------------	--------	-----------------	---------

description	paddle type A
--------------------	---------------



1

Part No.	695392	Ref. No.	A049063
-----------------	--------	-----------------	---------

description	spacer bush ID ø 16mm
--------------------	-----------------------

gaskets

miscellaneous



1

Part No.	695395	Ref. No.	A049505
-----------------	--------	-----------------	---------

description	gasket
--------------------	--------

knobs

producer-specific knobs

LINEA BLANCA



1

Part No.	110145	Ref. No.	A030068
-----------------	--------	-----------------	---------

description	knob thermostat t.max. 90°C 0-90°C ø 42mm shaft ø 6x4.6mm shaft flat -45° black
--------------------	---

pullouts

rollers

rollers

accessories



1

Part No.	560133	Ref. No.	A060002
-----------------	--------	-----------------	---------

description	hexagonal nut thread M6 H 5mm WS 10 SS DIN/ISO DIN 934 / ISO 4032/8673 Qty 20 pcs
--------------------	---

baskets

warewashing baskets

steel wire baskets square

mix baskets



1

Part No.	971001 ¹	Ref. No.	A050350
-----------------	---------------------	-----------------	---------

description	mix basket L 350mm W 350mm H 120mm mesh type wide-meshed
--------------------	--

¹wide-meshed



1 

Part No.	970067 ¹	Ref. No.	A050306
description	mix basket L 400mm W 400mm H 100mm		

¹wide-meshed

plate baskets

1 

Part No.	970069	Ref. No.	A050341
description	plate basket L 400mm W 400mm H 110mm plates 16 plate ø 200mm		

accessories

cutlery inserts

1 

Part No.	976011	Ref. No.	A050346
description	cutlery insert Lmm Wmm ø 110mm H 130mm		

sliding corners

1 

Part No.	970001	Ref. No.	A040242
description	sliding corner wire gauge ø 5mm L 120mm W 120mm H 12mm L-shape		

plate inserts

1 

Part No.	970047	Ref. No.	A050345
description	plate insert L 308mm W 100mm plates 15		

gaskets

O-rings

EPDM

1 

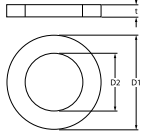

Part No.	528485	Ref. No.	A040029
description	O-ring EPDM thickness 1.78mm ID ø 6.07mm Qty 1 pcs		

1 

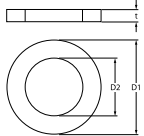

Part No.	530293	Ref. No.	A040021
description	O-ring EPDM thickness 1.78mm ID ø 8.73mm Qty 1 pcs		

1 

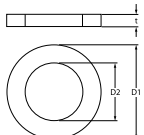

Part No.	361080	Ref. No.	A040023
description	O-ring EPDM thickness 2mm ID ø 16mm Qty 1 pcs		

1 

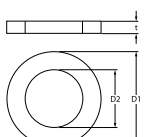

Part No.	510408	Ref. No.	A040026
description	O-ring EPDM thickness 5.34mm ID ø 47mm Qty 1 pcs		

sealing washers

fibre gaskets

1 

Part No.	521110	Ref. No.	A030402
description	flat gasket fibre ED ø 20mm ID ø 13mm thickness 2mm Qty 1 pcs		

1 

Part No.	503106	Ref. No.	A040043
description	flat gasket fibre ED ø 32mm ID ø 26mm thickness 3mm Qty 1 pcs		



refrigeration cycle components

cooling water regulators

JOHNSON CONTROLS



1

Part No.	541188	Ref. No.	A029011
description	cooling water regulator 3/8" type V46AA-9600 connection 7/16" UNF (1/4" SAE) pressure range 5-18bar water pressure max. 10bar water temperature max. 90°C capillary pipe 750mm L 160mm		

evaporators

for ice-cube maker

for ice cube maker



1

Part No.	750192	Ref. No.	A709301
description	evaporator for ice-cube maker 36 cubes L 335mm W 200mm H 45mm HA/HW35-50		

transmission technology and ball bearings

ball bearings

deep-groove ball bearings 2RS



1

Part No.	523509	Ref. No.	A050109
description	deep-groove ball bearing type 6201-2RS shaft \varnothing 12mm ED \varnothing 32mm W 10mm with sealing discs deep-groove ball bearing DIN 625-1		

angular contact ball bearings



1

Part No.	523546	Ref. No.	A050108I
description	deep-groove ball bearing shaft \varnothing 12mm ED \varnothing 32mm W 15.9mm type 3201-2RS DIN 628		

dosing pumps

peristaltic dosing pumps

GERMAC



built-in version



with frequency control



1

Part No.	361268	Ref. No.	A040067
description	dosing pump GERMAC frequency control 3l/h 230VAC detergent hose \varnothing 4x6mm hose thermoplastic type G300 built-in version dimensions 67x72x101mm		

spare parts for	361268			
	Part No.	361467	Ref. No.	—
	pump hose GERMAC detergent hose type thermoplastic hose \varnothing 6x10mm for model G43/G45/G53/G54/G55/G300/G305			
	Part No.	361557	Ref. No.	—
	control PCB type G300/G302/G305 GERMAC			
	Part No.	361589	Ref. No.	—
	roller assembly GERMAC suitable for G42/43/45/53/54/55/300/302/305/705			

accessories for	361268			
	Part No.	361106	Ref. No.	—
	container filter with weight and non-return valve SS hose \varnothing 4x6mm \varnothing 21mm L 51mm non return valve lip valve			
	Part No.	520090	Ref. No.	—
	PVC hose ID \varnothing 4mm ED \varnothing 6mm L 2m thickness 1mm t.max. 60°C transparent			
	Part No.	520091	Ref. No.	—
	nylon hose ID \varnothing 4mm ED \varnothing 6mm L 2m thickness 1mm operating p. 10bar burst p. 50bar t.max. 100°C transparent			



hoses

industrial hoses

extraction and pressure hoses



Part No.	530347	Ref. No.	A040233
description	universal hose ID ø 45mm ED ø 59mm L 0.5m operating p. 10bar burst p. 30bar temp.-resist. -30 up to +80°C		

fittings, hose and pipe connectors

hose connectors

without screw connection



Part No.	518347	Ref. No.	A040262
description	T-piece plastic hose ø 10-10-10mm 3-way		

ancillary products

clamps

hose clamps

DIN 3017 - W2



Part No.	520111	Ref. No.	A060170
description	hose clamp ø 10-16mm width 9mm Qty 10 pcs DIN 3017		



Part No.	520112	Ref. No.	A060171
description	hose clamp ø 12-20mm width 9mm Qty 10 pcs DIN 3017		



Part No.	520115	Ref. No.	A060172
description	hose clamp ø 25-40mm width 9mm Qty 10 pcs DIN 3017		



Part No.	520117	Ref. No.	A060173 A060174
description	hose clamp stainless steel ø 40-60mm width 9mm Qty 5 pcs DIN 3017		

fastening material

screws

sheet metal screws



Part No.	560108	Ref. No.	A060123
description	sheet metal screws ø 4.2mm L 13mm SS Qty 20 pcs DIN 7981/ISO 7049 head ø 8.2mm oval head		

countersunk screws



Part No.	560370	Ref. No.	A060134
description	countersunk screw thread M5 L 16mm stainless steel DIN 965/ISO 7046 Qty 1 pcs intake Phillips head ø 9mm		

flat-headed bolts





Part No.	560063	Ref. No.	A060081
description	flat-headed bolt thread M4 thread L 16mm SS DIN 7985/ISO 7045 Qty 20 pcs intake Phillips head ø 8mm head thickness 2mm		





			
1			
Part No.	560060	Ref. No.	A060078
description	flat-headed bolt thread M4 thread L 5mm SS DIN 7985/ISO 7045 Qty 20 pcs head ø 8mm head thickness 2mm		

hexagonal screws

			
1			
Part No.	560309	Ref. No.	A060086
description	hexagonal screw thread M10 thread L 16mm SS WS 17 Qty 1 pcs DIN 933 / ISO 4017		

			
1			
Part No.	560311	Ref. No.	A060110
description	hexagonal screw thread M10 thread L 20mm SS WS 17 Qty 1 pcs DIN 933 / ISO 4017		

			
1			
Part No.	560083	Ref. No.	A060092
description	hexagonal screw thread M5 thread L 10mm SS WS 8 Qty 20 pcs DIN 933 / ISO 4017		

			
1			
Part No.	524423	Ref. No.	A060082 A060115
description	hexagonal screw thread M6 thread L 10mm SS WS 10 Qty 1 pcs DIN 933 / ISO 4017		

			
1			
Part No.	524118	Ref. No.	A060089 A060133
description	hexagonal screw thread M6 thread L 16mm SS WS 10 Qty 1 pcs DIN 933 / ISO 4017		

			
1			
Part No.	560089	Ref. No.	A060083
description	hexagonal screw thread M6 thread L 25mm SS WS 10 Qty 20 pcs DIN 933 / ISO 4017		

			
1			
Part No.	503122	Ref. No.	A060104
description	hexagonal screw thread M8 thread L 10mm SS WS 13 Qty 1 pcs DIN 933 / ISO 4017		

			
1			
Part No.	506447	Ref. No.	A060105
description	hexagonal screw thread M8 thread L 16mm SS WS 13 Qty 1 pcs DIN 933 / ISO 4017		

			
1			
Part No.	550682	Ref. No.	A060084
description	hexagonal screw thread M8 thread L 20mm SS WS 13 Qty 1 pcs DIN 933 / ISO 4017		

cylinder head bolts

DIN 912/ISO 4762

			
1			
Part No.	560033	Ref. No.	A060103/1
description	cylinder head bolt thread M6 thread L 20mm WS 5 SS Qty 20 pcs DIN 912/ISO 4762		

grub screws

DIN 914/ISO 4027

			
1			
Part No.	560457	Ref. No.	A060252
description	grub screw thread M5 L 25mm stainless steel DIN 914/ISO 4027 intake hexagonal WS 2.5 Qty 1 pcs		

			
1			
Part No.	697410	Ref. No.	A060131
description	grub screw thread M5 L 6mm stainless steel DIN 914/ISO 4027 WS 2.5 with spike Qty 1 pcs		





nuts

hexagonal nuts

DIN 934 / ISO 4032/8673

 <p>1</p>			
Part No.	560199	Ref. No.	A060004
description	hexagonal nut thread M10 H 8mm WS 17 SS DIN/ISO DIN 934 / ISO 4032/8673 Qty 10 pcs		

 <p>1</p>			
Part No.	560223	Ref. No.	A060019
description	hexagonal nut thread M3 H 2.4mm WS 5.5 SS DIN/ISO DIN 934 / ISO 4032/8673 Qty 1 pcs		

 <p>1</p>			
Part No.	560340	Ref. No.	A060020
description	hexagonal nut thread M4 H 3.2mm WS 7 SS DIN/ISO DIN 934 / ISO 4032/8673 Qty 1 pcs		

 <p>1</p>			
Part No.	560131	Ref. No.	A060001
description	hexagonal nut thread M4 H 3.2mm WS 7 SS DIN/ISO DIN 934 / ISO 4032/8673 Qty 20 pcs		

 <p>1</p>			
Part No.	560129	Ref. No.	A060021
description	hexagonal nut thread M5 H 4mm WS 8 SS DIN/ISO DIN 934 / ISO 4032/8673 Qty 1 pcs		

 <p>1</p>			
Part No.	560132	Ref. No.	A060050
description	hexagonal nut thread M5 H 4mm WS 8 SS DIN/ISO DIN 934 / ISO 4032/8673 Qty 20 pcs		

 <p>1</p>			
Part No.	511212	Ref. No.	A060024
description	hexagonal nut thread M6 H 5mm WS 10 SS DIN/ISO DIN 934 / ISO 4032/8673 Qty 1 pcs		

 <p>1</p>			
Part No.	560133	Ref. No.	A060002
description	hexagonal nut thread M6 H 5mm WS 10 SS DIN/ISO DIN 934 / ISO 4032/8673 Qty 20 pcs		

 <p>1</p>			
Part No.	560134	Ref. No.	A060003 A060022
description	hexagonal nut thread M8 H 6.5mm WS 13 SS DIN/ISO DIN 934 / ISO 4032/8673 Qty 20 pcs		

 <p>1</p>			
Part No.	560197	Ref. No.	A060023
description	nut thread M10 H 8mm WS 17 SS DIN/ISO DIN 934 / ISO 4032/8673 Qty 1 pcs		

 <p>1</p>			
Part No.	506166	Ref. No.	A060025
description	nut thread M12 H 10mm WS 19 SS DIN/ISO DIN 934 / ISO 4032/8673 Qty 1 pcs		

DIN 985

 <p>1</p>			
Part No.	560142	Ref. No.	A060024/1
description	hexagonal nut thread M6 H 6mm SS WS 10 Qty 20 pcs DIN/ISO DIN 985 self-locking		



hexagonal nuts metric (without norm)



1

Part No.	521131	Ref. No.	A030403
-----------------	--------	-----------------	---------

description	nut thread M12x1 H 3.5mm WS 17 SS Qty 1 pcs		
--------------------	---	--	--

washers

spring rings



1

Part No.	560209	Ref. No.	A060155 A060156
-----------------	--------	-----------------	--------------------

description	lock washer ID \varnothing 10.3mm ED \varnothing 17.2mm SS Qty 1 pcs for thread M10		
--------------------	---	--	--



1

Part No.	560121	Ref. No.	A060165
-----------------	--------	-----------------	---------

description	lock washer ID \varnothing 4.2mm ED \varnothing 8mm SS DIN127 Qty 20 pcs for thread M4		
--------------------	--	--	--



1

Part No.	560123	Ref. No.	A060161
-----------------	--------	-----------------	---------

description	lock washer ID \varnothing 6.3mm ED \varnothing 11mm SS DIN127 Qty 20 pcs for thread M6		
--------------------	---	--	--



1

Part No.	560208	Ref. No.	A060160
-----------------	--------	-----------------	---------

description	lock washer ID \varnothing 8.3mm ED \varnothing 15mm SS Qty 1 pcs		
--------------------	---	--	--

washers

DIN 125A



1

Part No.	560111	Ref. No.	A060163
-----------------	--------	-----------------	---------

description	plain washer ID \varnothing 4.3mm ED \varnothing 9mm thickness 0.8mm SS Qty 20 pcs DIN 125A for thread M4		
--------------------	---	--	--

tooth lock washers

DIN 6798A



1

Part No.	560127	Ref. No.	A060151
-----------------	--------	-----------------	---------

description	tooth lock washer ID \varnothing 6.2mm ED \varnothing 11mm SS DIN/ISO DIN 6798A Qty 20 pcs for thread M6		
--------------------	--	--	--



1

Part No.	560128	Ref. No.	A060152
-----------------	--------	-----------------	---------

description	tooth lock washer ID \varnothing 8.3mm ED \varnothing 15mm SS DIN/ISO DIN 6798A Qty 20 pcs for thread M8		
--------------------	--	--	--

fasteners

clamps

hose clamps

DIN 3017 - W2



1

Part No.	520111	Ref. No.	A060170
-----------------	--------	-----------------	---------

description	hose clamp \varnothing 10-16mm width 9mm Qty 10 pcs DIN 3017		
--------------------	--	--	--



1

Part No.	520112	Ref. No.	A060171
-----------------	--------	-----------------	---------

description	hose clamp \varnothing 12-20mm width 9mm Qty 10 pcs DIN 3017		
--------------------	--	--	--



1

Part No.	520115	Ref. No.	A060172
-----------------	--------	-----------------	---------

description	hose clamp \varnothing 25-40mm width 9mm Qty 10 pcs DIN 3017		
--------------------	--	--	--



			
1			
Part No.	520117	Ref. No.	A060173 A060174
description	hose clamp stainless steel ø 40-60mm width 9mm Qty 5 pcs DIN 3017		

<p>DIN 6799</p> 			
1			
Part No.	691470	Ref. No.	A060153
description	retaining ring E D1 ø 8mm D2 ø 16mm SS DIN 6799 thickness 1mm for shaft ø 9-12mm		

retaining rings			
DIN 471			
			
1			
Part No.	523107	Ref. No.	A060166
description	retaining ring shaft ø 11mm thickness 1mm SS DIN 471		

GASTROPARTS.COM

