



GASTROPARTS

Fryland

- [EN]** Equipment
- [DE]** Geräte
- [ES]** Aparatos
- [FR]** Équipement
- [IT]** Attrezzature
- [PL]** Urządzenia
- [RU]** Оборудование

✉ gastroparts@gastroparts.com

☎ +48 56 657 00 66

📘 fb.com/gastroparts.global

GASTROPARTS.COM











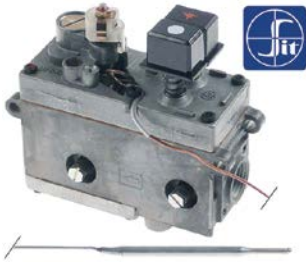













gas thermostats

SIT

710 Minisit series



| | | | |
|---|--|-----------------|-------------------|
| Part No. | 101135 | Ref. No. | 03137 |
| description | gas thermostat SIT type MINISIT 710 t.max. 190°C 110-190°C gas inlet 1/2" gas outlet 3/8" thermocouple connection M9x1 pilot connection M10x1 probe ø 6mm probe L 102mm capillary pipe 1050mm probe type type A3 pressure controller no pressure regulatormbar gland nut | | |
| For models: | Lt15+15g-ce | | |
| spare parts for | 101135 | | |
|  | Part No. | 101053 | Ref. No. — |
| | magnet unit T1: M9x1 T2: M24x1 L 45mm ø 17mm suitable for Minisit | | |
|  | Part No. | 102118 | Ref. No. — |
| | probe 110-190°C probe ø 6mm probe L 102mm capillary pipe 1050mm t.max. 190°C fryer probe type type A3 suitable for MINISIT 710 | | |
| accessories for | 101135 | | |
|  | Part No. | 100809 | Ref. No. — |
| | O-ring EPDM thickness 2mm ID ø 21mm Qty 1 pcs | | |
|  | Part No. | 100820 | Ref. No. — |
| | gland duct ET M14x1.5 IT M10x0.75 probe ø max. 6.5mm WS 22 | | |
|  | Part No. | 100904 | Ref. No. — |
| | locking screw M10x1 for pipe ø 4mm Qty 1 pcs | | |
|  | Part No. | 100905 | Ref. No. — |
| | locking screw M10x1 for pipe ø 6mm Qty 1 pcs | | |
|  | Part No. | 101054 | Ref. No. — |
| | magnet unit T1: M10x1 T2: M24x1 L 45mm ø 17mm suitable for Minisit | | |
|  | Part No. | 101136 | Ref. No. — |
| | piezoelectric igniter suitable for Minisit with cover cap ømm connection F6.3x0.8 | | |
|  | Part No. | 101137 | Ref. No. — |
| | cover cap without piezoelectric igniter | | |
|  | Part No. | 101267 | Ref. No. — |
| | reducer IT 3/8" ET 1/2" L 21mm | | |
|  | Part No. | 101268 | Ref. No. — |
| | gas connection thread 3/8" angled with O-ring MINISIT 710 | | |
|  | Part No. | 101269 | Ref. No. — |
| | gas connection thread 1/2" angled with O-ring MINISIT 710 | | |
|  | Part No. | 101270 | Ref. No. — |
| | screw connection IT 3/8" ET 3/8" L 28mm | | |

| | | | |
|---|--|--------|-------------------|
| accessories for | 101135 | | |
|  | Part No. | 101272 | Ref. No. — |
| | screw connection IT 1/2" ET 3/8" L 57mm | | |
|  | Part No. | 101273 | Ref. No. — |
| | olive for pipe ø 12mm L 9.5mm brass Qty 1 pcs suitable for universal | | |
|  | Part No. | 101274 | Ref. No. — |
| | olive for pipe ø 16mm Qty 1 pcs | | |
|  | Part No. | 101275 | Ref. No. — |
| | union screw thread 1/2" for pipe ø 16mm Qty 1 pcs | | |
|  | Part No. | 101276 | Ref. No. — |
| | union screw thread 3/8" tube ø 12mm Qty 1 pcs | | |
|  | Part No. | 110068 | Ref. No. — |
| | knob suitable for Minisit ø 37mm | | |

ignition parts

pilot burners

SIT

100 series











| | | | |
|---|--|-----------------|-------------------|
| Part No. | 107139 | Ref. No. | 03139 |
| description | pilot burner SIT type 100 series 1 flame nozzle ø 0.2mm gas connectionmm | | |
| For models: | Lt15+15g-ce | | |
| spare parts for | 107139 | | |
|  | Part No. | 100854 | Ref. No. — |
| | pilot burner bracket double | | |
|  | Part No. | 100885 | Ref. No. — |
| | air mixing sleeve for pilot burner Qty 1 pcs | | |
|  | Part No. | 107160 | Ref. No. — |
| | pilot burner cap SIT 1 flame Hmm Lmm Qty 1 pcs | | |
| accessories for | 107139 | | |
|  | Part No. | 100904 | Ref. No. — |
| | locking screw M10x1 for pipe ø 4mm Qty 1 pcs | | |
|  | Part No. | 100905 | Ref. No. — |
| | locking screw M10x1 for pipe ø 6mm Qty 1 pcs | | |
|  | Part No. | 100998 | Ref. No. — |
| | pilot burner bottom part nozzle ø 0.21mm suitable for 100 series | | |
|  | Part No. | 102110 | Ref. No. — |
| | pilot tube copper pipe ø 4mm thickness 1mm L 3000mm | | |

Table continues overleaf









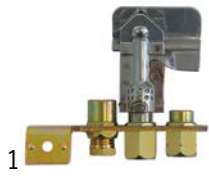













| | | | |
|---|--------|----------|---|
| accessories for | 107139 | | |
| Part No. | 102111 | Ref. No. | — |
|  | | | |
| pilot tube copper pipe ø 6mm thickness 1mm L 3000mm | | | |

POLIDORO

pilot burners





| | | | |
|--|---|----------|------------|
| Part No. | 100076 | Ref. No. | 03479 |
| description | pilot burner POLIDORO 3 flames natural gas code 29.2 gas connection 6mm | | |
| For models: | SC6FG | | |
| spare parts for | 100076 | | |
|  | Part No. | 100907 | Ref. No. — |
| screw connection thread M10x1 Qty 1 pcs type SEF 1 ømm for thermocouple | | | |
| accessories for | 100076 | | |
|  | Part No. | 100000 | Ref. No. — |
| pilot burner nozzle POLIDORO LPG code 22 bore ø 0.22mm Qty 1 pcs | | | |
|  | Part No. | 100208 | Ref. No. — |
| pilot burner nozzle POLIDORO LPG code 20 bore ø 0.2mm Qty 1 pcs | | | |
|  | Part No. | 100209 | Ref. No. — |
| pilot burner nozzle POLIDORO natural gas code 40 bore ø 0.4mm Qty 1 pcs | | | |
|  | Part No. | 100701 | Ref. No. — |
| ignition electrode connection M4 Qty 1 pcs | | | |
|  | Part No. | 100906 | Ref. No. — |
| screw connection thread M10x1 for ignition electrode brass Qty 1 pcs WS 10 | | | |
|  | Part No. | 100907 | Ref. No. — |
| screw connection thread M10x1 Qty 1 pcs type SEF 1 ømm for thermocouple | | | |
|  | Part No. | 100908 | Ref. No. — |
| union screw thread M10x1 for pipe ø 4mm Qty 1 pcs | | | |
|  | Part No. | 100909 | Ref. No. — |
| union screw thread M10x1 for pipe ø 6mm Qty 1 pcs | | | |
|  | Part No. | 102110 | Ref. No. — |
| pilot tube copper pipe ø 4mm thickness 1mm L 3000mm | | | |
|  | Part No. | 102111 | Ref. No. — |
| pilot tube copper pipe ø 6mm thickness 1mm L 3000mm | | | |
|  | Part No. | 102508 | Ref. No. — |
| union screw thread M10x1 for pipe ø 4mm Qty 5 pcs | | | |
|  | Part No. | 102509 | Ref. No. — |
| union screw thread M10x1 for pipe ø 6mm Qty 5 pcs | | | |
|  | Part No. | 102699 | Ref. No. — |
| pilot burner nozzle POLIDORO natural gas code 25.2 bore ø 2x0.25mm Qty 1 pcs 2 bores | | | |

| | | | |
|---|----------|--------|------------|
| accessories for | 100076 | | |
|  | Part No. | 102795 | Ref. No. — |
| olive for pipe ø 4mm Qty 1 pcs | | | |
|  | Part No. | 102797 | Ref. No. — |
| olive for pipe ø 6mm Qty 1 pcs | | | |
|  | Part No. | 106703 | Ref. No. — |
| pilot burner nozzle POLIDORO natural gas code 27.2 bore ø 2x0.27mm Qty 1 pcs | | | |
|  | Part No. | 106704 | Ref. No. — |
| pilot burner nozzle POLIDORO LPG code 16.2 bore ø 2x0.16mm Qty 1 pcs | | | |
|  | Part No. | 106763 | Ref. No. — |
| pilot burner nozzle POLIDORO natural gas code 27.2A bore ø 2x 0.27mm Qty 1 pcs | | | |
|  | Part No. | 106859 | Ref. No. — |
| pilot burner nozzle POLIDORO LPG code 24 bore ø 0.24mm Qty 1 pcs | | | |

piezoelectric igniters

miscellaneous



| | | | |
|---|--|----------|------------|
| Part No. | 107517 | Ref. No. | 03288 |
| description | piezoelectric igniter suitable for Minisit connection F6.3x0.8 with cover cap ø 22mm | | |
| spare parts for | 107517 | | |
|  | Part No. | 107564 | Ref. No. — |
| piezoelectric igniter body plastic blowing connection F6.3x0.8 ø 22mm | | | |
| accessories for | 107517 | | |
|  | Part No. | 100025 | Ref. No. — |
| ignition cable cable length 600mm connection ø4mm / F6.3mm | | | |



hinges

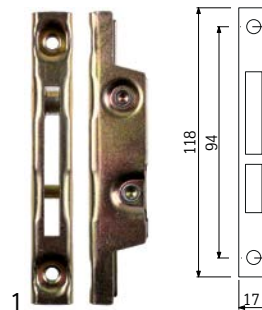

oven hinges



| | | | |
|-------------|--|----------|--------|
| Part No. | 700001 | Ref. No. | 03808c |
| description | opposite support L 118mm W 17mm mounting distance 94mm | | |

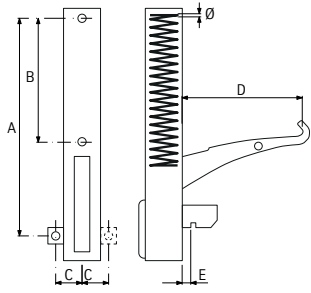

| | | | |
|---|--|-----------------|------------------------|
|  | | | |
| 1 | | | |
| Part No. | 700006 | Ref. No. | 03478D |
| description | oven hinge mounting distance 173mm mounting distance 2 105mm lug mounting 14mm lever length 120mm groove distance 11mm spring thickness 3.5mm mounting ear position left spring length 112mm W 25mm | | |
| accessories for | 700006 | | |
|  | Part No. | 700001 | Ref. No. 03808c |
| | opposite support L 118mm W 17mm mounting distance 94mm | | |
|  | Part No. | 700007 | Ref. No. 03478s |
| | oven hinge mounting distance 173mm mounting distance 2 105mm lug mounting 14mm lever length 120mm groove distance 11mm spring thickness 3.5mm mounting ear position right spring length 112mm W 25mm | | |

| | | | |
|---|--|-----------------|------------------------|
|  | | | |
| 1 |  | | |
| Part No. | 700007 | Ref. No. | 03478s |
| description | oven hinge mounting distance 173mm mounting distance 2 105mm lug mounting 14mm lever length 120mm groove distance 11mm spring thickness 3.5mm mounting ear position right spring length 112mm W 25mm | | |
| accessories for | 700007 | | |
|  | Part No. | 700001 | Ref. No. 03808c |
| | opposite support L 118mm W 17mm mounting distance 94mm | | |
|  | Part No. | 700006 | Ref. No. 03478D |
| | oven hinge mounting distance 173mm mounting distance 2 105mm lug mounting 14mm lever length 120mm groove distance 11mm spring thickness 3.5mm mounting ear position left spring length 112mm W 25mm | | |

GASTROPARTS.COM

