



GASTROPARTS

Cooking-Systems

- [EN]** Equipment
- [DE]** Geräte
- [ES]** Aparatos
- [FR]** Équipement
- [IT]** Attrezzature
- [PL]** Urządzenia
- [RU]** Оборудование

✉ gastroparts@gastroparts.com

☎ tel. +48 56 657 00 66

📘 fb.com/gastroparts.global

GASTROPARTS.COM





heating elements

heating elements for ovens

1			
Part No.	419068	Ref. No.	2127
description	heating element 2400W 230V heating circuits 3 L 505mm W 355mm L1 55mm L2 450mm W1 114mm W2 127mm flange length 170mm flange width 45mm hole distance 138mm bridge length 368mm hole ø 12/7mm tube ø 8mm connection M4 connection length 30mm windings 4 rectangular flange dry heating element oven		
For models:	3310, 4902		

1			
Part No.	419069	Ref. No.	2131
description	heating element 4000W 230V heating circuits 3 L 505mm W 510mm L1 55mm L2 450mm W1 191.5mm W2 127mm flange length 170mm flange width 45mm hole distance 138mm bridge length 520mm hole ø 12/7mm tube ø 8mm connection M4 connection length 30mm windings 6 rectangular flange dry heating element oven		
For models:	3481		

heating elements for fryers

2 hole fixing

group 2

1			
Part No.	419070	Ref. No.	2180
description	heating element 2200W 230V heating circuits 1 L 300mm W 110mm H 170mm L1 35mm L2 15mm L3 250mm thread M12x1.25 mounting distance 102mm tube ø 8mm windings 3 2 hole fixing connection M4 connection length 35mm fryer cover		
For models:	4205, 4255		

group 5

1			
Part No.	419067	Ref. No.	65720019
description	heating element 3000W 220V heating circuits 1 L 300mm W 205mm H 180mm 2 hole fixing connection M4 fryer heaters L1 35mm L2 15mm L3 250mm W1 42.5mm W2 120mm tube ø 8.5mm thread M12x1 mounting distance 112mm connection length 38mm windings 5		
For models:	4208, 4224, 4255, 4288		

heating elements for griddles

1			
Part No.	419077	Ref. No.	2179
description	heating element 1000W 230V heating circuits 1 L 265mm W 180mm H 25mm tube ø 6.2mm W1 55mm W2 70mm connection M5 grill connection distance 65mm dry heating element		
For models:	4401, 4402E, 4403E, 4404E, 4405E, 4442E, 4443E, 4444E, 4445E, 4462		

heating elements for pizza ovens

1			
Part No.	416565	Ref. No.	95591400
description	heating element 1270W 400V L 650mm W 215mm thread 1/4" mounting distance 206mm connection length 81mm connection male faston 6.3mm tube ø 8.5mm heating circuits 1 dry heating element mounting pos. upper 2 hole fixing		
accessories for	416565		
	Part No.	361182	Ref. No. —
	nut thread 1/4" H 5mm nickel-plated brass WS 17 Qty 1 pcs		
	Part No.	510417	Ref. No. —
	flat gasket fibre ED ø 20mm ID ø 14mm thickness 2mm Qty 1 pcs		
	Part No.	520228	Ref. No. —
	tooth lock washer ID ø 15.3mm ED ø 24mm steel Qty 1 pcs for thread M14		
	Part No.	550262	Ref. No. —
	flat gasket copper ED ø 20mm ID ø 14mm thickness 2mm		



heating elements for heated cabinets





Part No.	418860	Ref. No.	910950017
description	heating element 800W 230V heating circuits 1 L 345mm W 90mm thread M12x1.5 mounting distance 83mm tube ø 6.5mm connection male faston 6.3mm dry heating element 2 hole fixing		

ceramic heaters

245x60mm



Part No.	415102	Ref. No.	2088
description	ceramic emitter 400W 230V cable beaded cord L 245mm W 60mm H 35mm		
For models:	3018, 4421		
spare parts for	415102		
	Part No.	415109	Ref. No. —
		spring clip	
accessories for	415102		
	Part No.	415110	Ref. No. —
		reflector L 245mm W 95mm H 31mm thickness 0.75mm hole ø 15x40mm	

coil heating elements



Part No.	419071	Ref. No.	2264
description	heating element 1000W 230V L 370mm W 50mm H 25mm tube ø 8mm thread M12x1.25 connection M4 connection length 30mm dry heating element heating circuits 1 2 hole fixing		
For models:	3018, 6190, 6190E1		

radiation heaters



Part No.	419076	Ref. No.	97032038
description	heating element rectangular L 840mm W 190mm 2500W 230/400V H 40mm cable length 450mm chicken rotisserie		
For models:	5305, 53054, 5310, 53104, 5315, 53154, 5320, 53204, 5330, 53304, 5340, 53404, 5360, 53604, 5380, 53804		

foil heating elements



Part No.	419075	Ref. No.	C5421210
description	foil heating element L 400mm W 290mm 1000W 230V t.max. 150°C silicone cable length 2000mm thickness 1mm bain marie		
For models:	3016, 3701, 3701S, 3702, 3702S, 3703, 3703S, 3704, 3704S, 505		

accessories

capillary tube clips



Part No.	550138	Ref. No.	68560069
description	capillary tube clip for pipe ø 8.5mm for circular tube heating elements		
For models:	30172, 30252, 4205, 4208, 4212, 4224, 4255, 4288		

spring clips



Part No.	551078	Ref. No.	69340099
description	probe spring for pipe ø 8mm for probe ø 5mm L 30mm W 10mm wire gauge ø 1mm		
For models:	30172, 30252, 4205, 4208, 4212, 4224, 4255, 4288		

hot plates

round



with radiused edge

for domestic and commercial kitchens



Part No.	490018	Ref. No.	3216
description	hot plate ø 220mm 2000W 230V connection 4 screw clamps with 8mm spill ring		
For models:	3031, 3310, 4418, 4419, 4481, 4482, 4483		



 <p>1</p>			
Part No.	490020	Ref. No.	3235
description	hot plate ø 220mm 2600W 230V connection 4 screw clamps with 8mm spill ring		
For models:	3031, 3310		
accessories for	490020		
	Part No.	550796	Ref. No.
	 <p>fixing plate for hot plate ø220mm</p>		

energy regulators

EGO

1-circuit

 <p>1</p>			
Part No.	380015	Ref. No.	C5322489
description	energy regulator 230V 13A single-circuit turn direction right shaft ø 6x4.6mm shaft L 23mm mounting thread M4 power release 6-100% no. 50.57021.010		
For models:	5305, 53054, 5310, 53104, 5315, 53154, 5320, 53204, 5330, 53304, 5340, 53404, 5355, 5360, 53604, 5375, 5380, 53804		

thermostats

control and safety thermostats

EGO

control thermostats

55.13_series

 <p>1</p>			
Part No.	375505	Ref. No.	2221
description	thermostat t.max. 320°C temperature range 50-320°C 1-pole 1NO 16A probe ø 3mm probe L 160mm capillary pipe 870mm capillary pipe isolatedmm gland nut shaft ø 6x4.6mm shaft L 23mm shaft position upper rotation 270°		
For models:	3007, 3009, 3011, 3310, 3481, 3483, 3615, 3626, 4402E, 4403E, 4404E, 4405E, 4442E, 4443E, 4444E, 4445E, 4902, 4904, 4908		

IMIT / TEMPOMATIC / ARTHERMO

control thermostats

 <p>1</p>			
Part No.	375939	Ref. No.	C5322059
description	thermostat t.max. 200°C temperature range 0-200°C 1-pole 1CO 16A probe ø 5mm probe L 98mm capillary pipe 1040mm capillary pipe isolatedmm gland nut shaft ø 6x4.6mm shaft L 20mm		
For models:	30172, 30252, 4205, 4208, 4212, 4224, 4255, 4288, FRF20		

safety thermostats

 <p>1</p>			
Part No.	375941	Ref. No.	C5322209
description	safety thermostat switch-off temp. 238°C 1-pole 1NC 16A probe ø 5mm probe L 100mm capillary pipe 1050mm capillary pipe isolatedmm gland nut 250V		
For models:	30172, 30252, 4205, 4208, 4212, 4224, 4255, 4288, FRF20		

various

control thermostats

 <p>1</p>			
Part No.	390750	Ref. No.	C5322609
description	thermostat t.max. 240°C 1-pole 1NO 10A shaft ø 6x4.6mm shaft position 20°		
For models:	4401, 4462		

Part No.	375940	Ref. No.	C5322579
description	thermostat temperature range 30-90°C 1-pole 1CO 16A probe ø 6mm probe L 108mm capillary pipe 1530mm shaft ø 6x4.6mm shaft L 12mm rotation 270° 400V		
For models:	3016, 3018, 3701, 3701S, 3702, 3702S, 3703, 3703S, 3704, 3704S, 4420, 4421		

safety thermostats



Part No.	390754	Ref. No.	92011140
description	safety thermostat switch-off temp. 240°C 1-pole 0.5A probe ø 6mm probe L 79mm capillary pipe 860mm capillary pipe isolated 750mm probe thread M10x1 connection with cable cable length 600mm		
For models:	3026, 3027, 3027V		
spare parts for	390754		
	Part No.	375783	Ref. No.
	safety thermostat switch-off temp. 240°C 1-pole 0.5A probe ø 6mm probe L 77mm capillary pipe 860mm capillary pipe isolated 750mm gland nut M10x1 probe SS		

accessories

capillary tube clips



Part No.	550138	Ref. No.	68560069
description	capillary tube clip for pipe ø 8.5mm for circular tube heating elements		
For models:	30172, 30252, 4205, 4208, 4212, 4224, 4255, 4288		

switches and momentary switches

rocker/momentary rocker switches

ø20mm



Part No.	357074	Ref. No.	C5120729
description	rocker switch mounting measurements 20mm red 2NO 250V 10A I O connection male faston 4.8mm ambient temperature max. 85°C protection IP40		
For models:	1161, 3018, 3310, 3481, 3483, 4401, 4421, 4462, 4902, 4904, 4908, 5305, 53054, 5310, 53104, 5315, 53154, 5320, 53204, 5330, 53304, 5340, 53404, 5355, 5360, 53604, 5375, 5380, 53804, 704, 7050, 70501, 7052, 706, 7062, 731, 734, 743, 7460, 7464, 7500, 7502, 75021, 7530, 7535, 75351		

cam switches

4-position

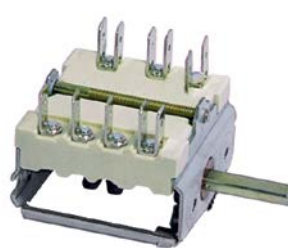

Part No.	300007	Ref. No.	3218
description	cam switch 4 operating positions 1NO/2CO sequence 0-1-2-3 16A shaft ø 6x4.6mm shaft L 23mm connection male faston 6.3mm 4-position ceramic		
For models:	3031, 33075, 3310, 3327, 3481, 3483, 4418, 4419, 4481, 4482, 4483, 54244, 54364, 54484		

lamps

indicator lights

indicator lights (complete)

ø 6mm



Part No.	357072	Ref. No.	C5120219 C5120229
description	indicator light ø 6mm 220V red connection cable 300mm cable length 300mm metal		
For models:	3007, 3009, 3011, 3016, 30172, 3018, 30252, 3031, 3033, 33075, 3310, 33115, 3327, 3481, 3483, 3615, 3626, 3701, 3701S, 3702, 3702S, 3703, 3703S, 3704, 3704S, 4205, 4208, 4212, 4224, 4255, 4288, 4402E, 4403E, 4404E, 4405E, 4418, 4419, 4420, 4421, 4442E, 4443E, 4444E, 4445E, 4481, 4482, 4483, 4808, 4902, 4904, 4908...(Other models you can see in the webshop)		

ø20mm



Part No.	357073	Ref. No.	C5120719
description	indicator light ø 20mm 250V red connection male faston 4.8mm temp.-resist. 105°C		
For models:	704, 7050, 70501, 7052, 706, 7062, 731, 734, 743, 7460, 7464, 7500, 7502, 75021, 7530, 7535, 75351		



screw-on/push-on fit

light bulbs

for ovens



Part No.	359610	Ref. No.	C512409
description	light bulb t.max. 300°C socket E14 15W 230V ø 22mm L 47mm lens L 20mm for oven lamp type Philips		

oven lamps

universal oven lamps

55x100mm



Part No.	101372	Ref. No.	C5125419	
description	oven lamp complete L 100mm W 55mm 230V 25W socket E14 rectangular temp.-resist. 300°C connection male faston 6.3mm			
For models:	5301, 5305, 53054, 5310, 53104, 5315, 53154, 5320, 53204, 5330, 53304, 5336, 5340, 53404, 5348, 5355, 5360, 53604, 5372, 5375, 5380, 53804, 5396, 5424, 54244, 5436, 54364, 5448, 54484, 5453, 5496			
spare parts for	101372			
	Part No.	359612	Ref. No.	—
		light bulb t.max. 300°C socket E14 25W 230V ø 25mm L 56mm lens L 30mm for oven lamp type Philips		
	Part No.	359698	Ref. No.	—
		lamp socket L 100mm W 55mm socket E14 connection male faston 6.3mm		
	Part No.	359714	Ref. No.	—
		gasket for bulb socket		
	Part No.	359715	Ref. No.	—
		lamp glass L 110mm W 65mm thickness 5mm		
	Part No.	359716	Ref. No.	—
		frame for bulb socket		

lamps

light bulbs



Part No.	359610	Ref. No.	C512409
description	light bulb t.max. 300°C socket E14 15W 230V ø 22mm L 47mm lens L 20mm for oven lamp type Philips		

contactors

LS Industrial Systems

power contactors



Part No.	380944	Ref. No.	C5123179
description	power contactor resistive load 20A 230VAC (AC3/400V) 12A/5.5kW main contacts 3NO auxiliary contacts 1NO/1NC connection screw connection type GMC-12		
For models:	30252, 3615, 3626, 4904, 4908		

electronic controllers

miscellaneous

refrigeration controllers



Part No.	378271	Ref. No.	C5322529
description	electronic controller OSAKA type T2001 AN /HSH5 mounting measurements 71x29mm 100-240V voltage AC NTC display 4 digits NTC/PTC		
For models:	1161, 505, 5453, 602, 6021, 6022, 603, 6031, 605, 606, 6190, 6190E1, 704, 7050, 70501, 7052, 706, 7062, 731, 734, 743, 7460, 7464, 7500, 7502, 75021, 7530, 7535, 75351		

motors

gear motors

for grills



Part No.	499110	Ref. No.	C5020039
description	gear motor CROUZET 230V 50Hz 4rpm shaft ø 6x5mm L 91mm W 64mm H 58mm		
For models:	5305, 53054, 5310, 5315, 5320, 5330, 5340, 5360, 5380		

1

Part No.	499111	Ref. No.	534027P
description	gear motor CEG type MM56A4-STD 90W 230V 50Hz 6500rpm L 705mm W 115mm H 550mm chicken rotisserie 0.12HP		
For models:	5310, 53104, 5315, 53154, 5330, 53304, 5340, 53404, 5355, 5360, 53604, 5375, 5380, 53804		

gas taps

PEL

20S series



1

Part No.	106840	Ref. No.	3780
description	gas tap PEL type 20S gas inlet pipe flange ø21mm bypass nozzle ø 0mm gas outlet M16x1.5 (tube ø 10/8mm) thermocouple connection M8x1 pilot connection shaft ø 8x6.5mm shaft L 22/15mm shaft flat upper		
For models:	5305, 53054, 5310, 53104, 5315, 53154, 5320, 53204, 5330, 53304, 5340, 53404, 5355, 5360, 53604, 5375, 5380, 53804		
spare parts for	106840		
	Part No.	101060	Ref. No. —
	magnet unit standard L 39mm D1 ø 15.4mm D2 ø 11mm suitable for PEL20-21/JUNKERS/EGA		
	Part No.	101205	Ref. No. —
	gas tap front part shaft ø 8x6.5mm shaft L 22/15mm shaft flat upper/lower suitable for PEL20		
	Part No.	101880	Ref. No. —
	gasket Viton ED ø 14mm ID ø 9mm thickness 7.7mm Qty 1 pcs		
	Part No.	106202	Ref. No. —
	bypass nozzle type PEL20/21 bore ø 0mm thread M5x0.5		
accessories for	106840		
	Part No.	101230	Ref. No. —
	thermocouple nut T1: M8x1 T2: M18x1 aluminium		
	Part No.	101278	Ref. No. 3781
	olive for pipe ø 10mm Qty 1 pcs		
	Part No.	101300	Ref. No. 3782
	union nut thread M16x1.5 tube ø 10mm		
	Part No.	101450	Ref. No. —
	olive for pipe ø 8mm L 12.7mm Qty 1 pcs ED ø 10mm		
	Part No.	101451	Ref. No. —
	union nut thread M16x1.5 tube ø 8mm		

21S series



1

Part No.	106841	Ref. No.	C5811429
description	gas tap PEL type 21S gas inlet pipe flange ø21mm bypass nozzle ø 0mm gas outlet M16x1.5 (tube ø 10mm) thermocouple connection M9x1 pilot connection M10x1 shaft ø 8x6.5mm shaft L 22/15mm shaft flat right pipe input ø 9mm		
For models:	3013, 3014, 3015, 3302, 33025, 3303, 33035, 3304, 3306, 3331, 3401, 3402, 3404S, 3405S, 3411S, 34121S, 3412S-Vers1, 3412S-Vers2, 3413SE1, 34151S, 3415S, 3501, 3501C, 3504, 3511SE1, 3592, 3911, 3912, 4001, 4437, 4701S, 4702, 4703, 4704, 4801, 4803, 4803E, 4805, 4807, 4811, 4815, 4920, 49201, 49202, 4930, 49301, 5051, 5052S		
spare parts for	106841		
	Part No.	101060	Ref. No. —
	magnet unit standard L 39mm D1 ø 15.4mm D2 ø 11mm suitable for PEL20-21/JUNKERS/EGA		
	Part No.	101231	Ref. No. —
	thermocouple nut T1: M9x1 T2: M18x1		
	Part No.	106202	Ref. No. —
	bypass nozzle type PEL20/21 bore ø 0mm thread M5x0.5		
accessories for	106841		
	Part No.	100908	Ref. No. —
	union screw thread M10x1 for pipe ø 4mm Qty 1 pcs		
	Part No.	100909	Ref. No. A1018997
	union screw thread M10x1 for pipe ø 6mm Qty 1 pcs		
	Part No.	101246	Ref. No. —
	olive for pipe ø 4mm Qty 1 pcs		
	Part No.	101278	Ref. No. 3781
	olive for pipe ø 10mm Qty 1 pcs		
	Part No.	101286	Ref. No. —
	olive ID ø 6mm Qty 1 pcs		
	Part No.	101300	Ref. No. 3782
	union nut thread M16x1.5 tube ø 10mm		
	Part No.	101450	Ref. No. —
	olive for pipe ø 8mm L 12.7mm Qty 1 pcs ED ø 10mm		
	Part No.	101451	Ref. No. —
	union nut thread M16x1.5 tube ø 8mm		
	Part No.	110081	Ref. No. —
	knob ø 70mm shaft ø 8x6.5mm shaft flat universal		
	Part No.	112206	Ref. No. —
	knob dial plate silver gas tap PEL21/22/23 t.max.°C ED ø 63mm ID ø 45.5mm		



SABAF







1

Part No.	106842	Ref. No.	C5816299
description	gas tap SABAF type 10 gas inlet pipe flange ø23mm bypass nozzle ø 0mm gas outlet 1/4" (tube ø 8mm) front fixing M13x1 thermocouple connection M8x1 shaft ø 8x6.5mm shaft L 32/12.5mm shaft flat right		
For models:	3300, 35012, 4402, 4402M, 4403, 4403M, 4404, 4404M, 4405, 4405M, 4409, 4410, 4411, 4412, 4413, 44138, 4416, 4417, 4422, 4423, 4424, 4425, 4442, 4443, 4444, 4445, 4462, 4471, 4472, 4473, 5315, 5320, 5330, 5336, 5340, 5348, 5355, 5372, 5375, 5396, 5424, 5436, 5448, 54484, 5496		
spare parts for	106842		
	Part No.	101051	Ref. No. —
	magnet unit L 27mm D1 ø 12.5mm D2 ø 8.5mm suitable for JUNKERS/EGA/MADEC/SABAF standard		
	Part No.	101376	Ref. No. —
	gasket ID ø 8mm ED ø 12mm H 3/5mm		
accessories for	106842		
	Part No.	101277	Ref. No. C5815549
	olive ID ø 8mm Qty 1 pcs		
	Part No.	101751	Ref. No. —
	bracket		
	Part No.	520656	Ref. No. —
	union nut thread 1/4" tube ø 6/8mm		



1

Part No.	106843	Ref. No.	C5816289
description	gas tap SABAF type 10 gas inlet pipe flange ø23mm bypass nozzle ø 0mm gas outlet 1/4" (tube ø 8mm) front fixing thermocouple connection M8x1 shaft ø 8x6.5mm shaft L 47/12.5mm shaft flat right		
For models:	30012, 30032, 30132, 30142, 30152, 3300, 3301, 33022, 33042, 33052, 33062, 33092, 35012		
spare parts for	106843		
	Part No.	101051	Ref. No. —
	magnet unit L 27mm D1 ø 12.5mm D2 ø 8.5mm suitable for JUNKERS/EGA/MADEC/SABAF standard		
	Part No.	101376	Ref. No. —
	gasket ID ø 8mm ED ø 12mm H 3/5mm		
accessories for	106843		
	Part No.	101277	Ref. No. C5815549
	olive ID ø 8mm Qty 1 pcs		
	Part No.	101751	Ref. No. —
	bracket		

accessories for	106843		
	Part No.	520656	Ref. No. —
	union nut thread 1/4" tube ø 6/8mm		

gas thermostats

SIT

710 Minisit series



1









Part No.	101132	Ref. No.	3103
description	gas thermostat SIT type MINISIT 710 t.max. 340°C 100-340°C gas inlet 1/2" gas outlet 3/8" thermocouple connection M9x1 pilot connection M10x1 probe ø 5mm probe L 68mm capillary pipe 1050mm probe type type B1 pressure controller no pressure regulator mbar gland nut ignition gas no		
For models:	3001, 3003, 3005, 3401, 3402, 3501, 3592, 3607, 3611S, 3614S, 3624, 3628H, 3628S, 3683S, 3684S, 3907, 4001, 4812, 4812E, 4815, 4817, 4903, 4907, 4999		
spare parts for	101132		
	Part No.	101053	Ref. No. —
	magnet unit T1: M9x1 T2: M24x1 L 45mm ø 17mm suitable for Minisit		
	Part No.	102102	Ref. No. —
	probe 100-340°C probe ø 5mm probe L 68mm capillary pipe 1750mm t.max. 340°C oven/grill probe type type B1 suitable for MINISIT 710		
accessories for	101132		
	Part No.	100809	Ref. No. 3785
	O-ring EPDM thickness 2mm ID ø 21mm Qty 1 pcs		
	Part No.	100904	Ref. No. —
	locking screw M10x1 for pipe ø 4mm Qty 1 pcs		
	Part No.	100905	Ref. No. C5815359
	locking screw M10x1 for pipe ø 6mm Qty 1 pcs		
	Part No.	101054	Ref. No. —
	magnet unit T1: M10x1 T2: M24x1 L 45mm ø 17mm suitable for Minisit		
	Part No.	101136	Ref. No. —
	piezoelectric igniter suitable for Minisit with cover cap ømm connection F6.3x0.8		
	Part No.	101137	Ref. No. —
	cover cap without piezoelectric igniter		
	Part No.	101267	Ref. No. —
	reducer IT 3/8" ET 1/2" L 21mm		
	Part No.	101268	Ref. No. —
	gas connection thread 3/8" angled with O-ring MINISIT 710		

Table continues overleaf



accessories for	101132		
	Part No.	101269	Ref. No. —
	gas connection thread 1/2" angled with O-ring MINISIT 710		
	Part No.	101270	Ref. No. —
	screw connection IT 3/8" ET 3/8" L 28mm		
	Part No.	101272	Ref. No. —
	screw connection IT 1/2" ET 3/8" L 57mm		
	Part No.	101273	Ref. No. —
	olive for pipe ø 12mm L 9.5mm brass Qty 1 pcs suitable for universal		
	Part No.	101274	Ref. No. —
	olive for pipe ø 16mm Qty 1 pcs		
	Part No.	101275	Ref. No. —
	union screw thread 1/2" for pipe ø 16mm Qty 1 pcs		
	Part No.	101276	Ref. No. —
	union screw thread 3/8" tube ø 12mm Qty 1 pcs		
	Part No.	110068	Ref. No. —
	knob suitable for Minisit ø 37mm		

gas valves and ignition boxes

gas control valves

SIT

NOVASIT

accessories



Part No.	101799	Ref. No.	C582109
description	knob adapter shaft ø 10x8mm shaft L 18mm catch lower suitable for ZANUSSI shaft flat upper		



Part No.	100905	Ref. No.	C5815359
description	locking screw M10x1 for pipe ø 6mm Qty 1 pcs		
For models:	3001, 3003, 3005, 3013, 3014, 3015, 3026, 3027, 3027V, 3302, 3302S, 3303, 3303S, 3304, 3306, 3331, 3401, 3402, 3404S, 3405S, 3411S, 34121S, 3412S-Vers1, 3412S-Vers2, 3413SE1, 34151S, 3415S, 3501, 3501C, 3504, 3511SE1, 3592, 3607, 3611S, 3614S, 3624, 3628H, 3628S, 3683S, 3684S, 3907, 3908, 3911, 3912, 4437, 4701S, 4702, 4703, 4704, 4801...(Other models you can see in the webshop)		

ignition parts

pilot burners

SIT

100 series

accessories

pilot burner brackets

universal



Part No.	100894	Ref. No.	3705
description	opposite support for pilot burner suitable for 100 series		
For models:	30012, 30032, 30132, 30142, 3300, 3301, 3302, 33022, 35012, 4409, 4410, 4901		



Part No.	100893	Ref. No.	3786
description	pilot burner bracket suitable for 100 series 2-piece		
For models:	30012, 30032, 30132, 30142, 3300, 3301, 3302, 33022, 35012, 4409, 4410, 4901		



Part No.	100888	Ref. No.	3704
description	screw bolt for pilot burner		
For models:	3300, 3301, 35012, 4409, 4410, 4901		

miscellaneous



Part No.	100885	Ref. No.	C5815189
description	air mixing sleeve for pilot burner Qty 1 pcs		
For models:	3015, 3302, 3302S, 3303, 3303S, 3304, 3306, 3331, 3401, 3402, 3404S, 3405S, 3411S, 34121S, 3412S-Vers1, 3412S-Vers2, 3413SE1, 34151S, 3415S, 3501, 3501C, 3504, 3511SE1, 3592, 4001, 4437, 4920, 49201, 49202, 4930, 49301, 5051, 5052S		



POLIDORO
pilot burners

Part No.	106837	Ref. No.	C5810129
description	pilot burner POLIDORO 3 flames natural gas code 27.2		
For models:	3001, 3003, 3005, 3013, 3014, 3026, 3027, 3027V, 3401, 3402, 3501, 3592, 3607, 3611S, 3614S, 3624, 3628H, 3628S, 3683S, 3684S, 3907, 3908, 3911, 3912, 4001, 4701S, 4702, 4703, 4704, 4801, 4803, 4803E, 4805, 4807, 4811, 4812, 4812E, 4815, 4817, 4903, 4907, 4999		

Part No.	100906	Ref. No.	A1018998
description	screw connection thread M10x1 for ignition electrode brass Qty 1 pcs WS 10		
For models:	3001, 3003, 3005, 3013, 3014, 3026, 3027, 3027V, 3401, 3402, 3501, 3592, 3607, 3611S, 3614S, 3624, 3628H, 3628S, 3683S, 3684S, 3907, 3911, 3912, 4001, 4701S, 4702, 4703, 4704, 4801, 4803, 4803E, 4805, 4807, 4811, 4812, 4812E, 4815, 4817, 4903, 4907, 4999		

electrodes

Part No.	100701	Ref. No.	C5810139
description	ignition electrode connection M4 Qty 1 pcs		
For models:	3001, 3003, 3005, 3013, 3014, 3026, 3027, 3027V, 3401, 3402, 3501, 3592, 3607, 3611S, 3614S, 3624, 3628H, 3628S, 3683S, 3684S, 3907, 3908, 3911, 3912, 4001, 4701S, 4702, 4703, 4704, 4801, 4803, 4803E, 4805, 4807, 4811, 4812, 4812E, 4815, 4817, 4903, 4907, 4999		
accessories for	100701		
	Part No.	Ref. No.	A1018998
	100906		
	screw connection thread M10x1 for ignition electrode brass Qty 1 pcs WS 10		

Part No.	102314	Ref. No.	96010061
description	ignition electrode D1 ø 7mm D2 ø 9mm connection M4 L1 2mm BL1 28mm BL2 3mm BL3 23mm to clip		
For models:	3911, 3912		

ignition cables

pre-assembled cables

Part No.	102164	Ref. No.	2175
description	ignition cable cable length 1000mm connection F6.3mm / lug M4		
For models:	30012, 3003, 30032, 3005, 3013, 30132, 3014, 30142, 3300, 3301, 3302, 33022, 3401, 3402, 3501, 35012, 3592, 3611S, 3628H, 3628S, 3908, 3911, 3912, 4001, 4409, 4410, 4702, 4703, 4704, 4801, 4803, 4803E, 4805, 4807, 4811, 4815, 4901, 4903, 4907, 4999		

Part No.	102177	Ref. No.	2193
description	ignition cable cable length 600mm connection F6.3mm / lug M4		
For models:	3001, 3003, 3005, 3026, 3027, 3027V, 3607, 3611S, 3614S, 3624, 3683S, 3684S, 4701S, 4702, 4812, 4812E, 4815, 4817		

piezoelectric igniters

miscellaneous

Part No.	nla ¹	Ref. No.	3747
description	piezoelectric igniter suitable for Minisit connection F6.3x0.8 ømm		
For models:	3001, 3003, 3005, 3013, 3014, 3027, 3027V, 3300, 3301, 3401, 3402, 3501, 35012, 3592, 3611S, 3614S, 3624, 3628H, 3628S, 3683S, 3684S, 4001, 4409, 4410, 44138, 4702, 4803, 4812, 4815, 4817, 4999		

¹no longer available



thermocouples

plug-in thermocouples

plug-in thermocouples standard

with barrel socket $\varnothing 6(6.5)$ mm

thermocouples SIT

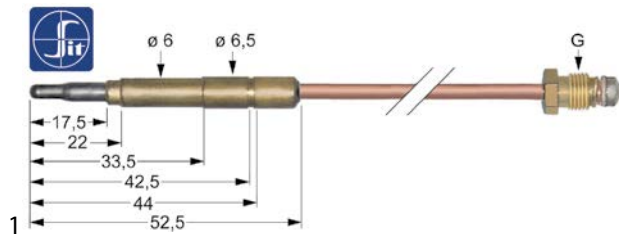

Part No.	107602	Ref. No.	C5811809
description	thermocouple SIT M8x1 L 850mm plug connection $\varnothing 6.0(6.5)$ mm		
For models:	30012, 30032, 30132, 30142, 3300, 3301, 3302, 33022, 35012, 4409, 4410, 4901		
accessories for	107602		
	Part No.	100920	Ref. No. —
	thermocouple fitting thread M8x1 / M9x1 Qty 1 pcs		
	Part No.	100922	Ref. No. —
	thermocouple fitting thread M10x1 / ASA 11/32 Qty 1 pcs		

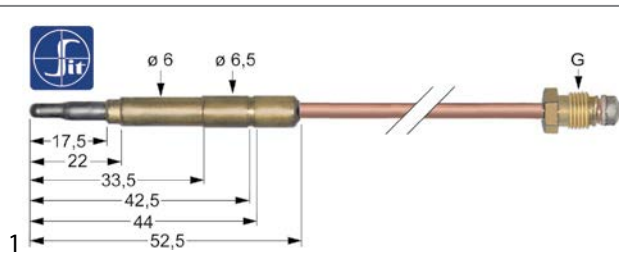

Part No.	107612	Ref. No.	C5811009
description	thermocouple SIT M9x1 L 1000mm plug connection $\varnothing 6.0(6.5)$ mm		
For models:	4815		

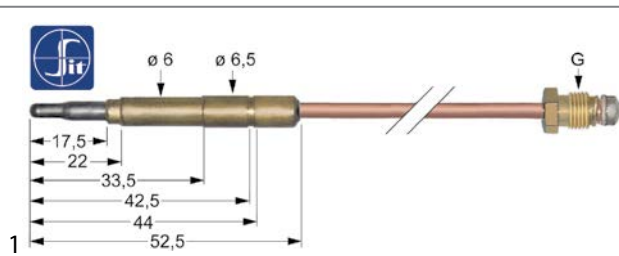

Part No.	107614	Ref. No.	C5811059
description	thermocouple SIT M9x1 L 1500mm plug connection $\varnothing 6.0(6.5)$ mm		
For models:	3501, 4801, 4803, 4803E, 4805, 4807, 4811		

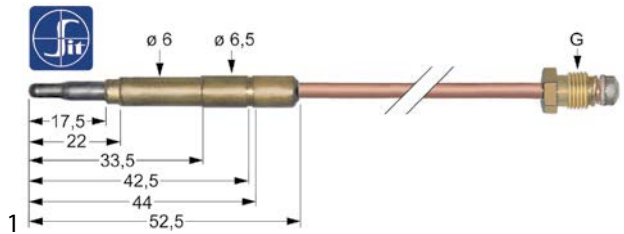

Part No.	107606	Ref. No.	C5820049
description	thermocouple SIT M9x1 L 320mm plug connection $\varnothing 6.0(6.5)$ mm		
For models:	10P, 20P, 3001, 3003, 3005, 3026, 3027, 3027V, 30P, 3607, 3611S, 3614S, 3624, 3683S, 3684S, 40P, 4701S, 4702, 4812, 4812E, 4817, 5305, 5310, 5315, 5320, 5330, 5340, 5360, 5380, 5P		

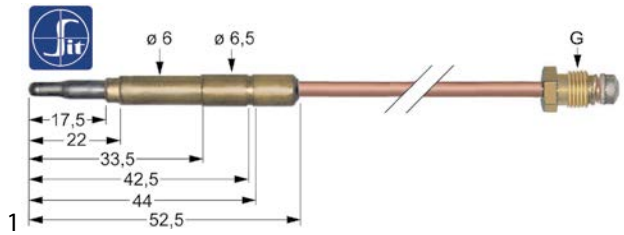

Part No.	107609	Ref. No.	C5811829
description	thermocouple SIT M9x1 L 600mm plug connection $\varnothing 6.0(6.5)$ mm		
For models:	3003, 3005, 3013, 3014, 3027, 3027V, 3302, 33022, 3401, 3402, 3501, 3592, 3611S, 3628H, 3628S, 3911, 3912, 4001, 4702, 4703, 4704, 4803, 4815, 4901, 4999		

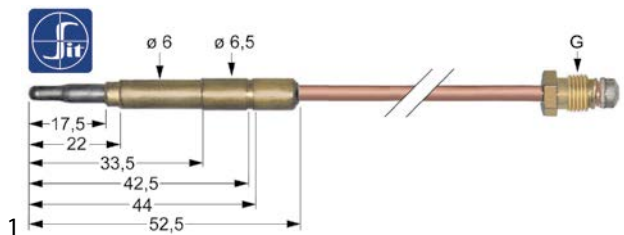

Part No.	107611	Ref. No.	C5811679
description	thermocouple SIT M9x1 L 850mm plug connection $\varnothing 6.0(6.5)$ mm		
For models:	3401, 4903, 4907, 4999		

threaded thermocouples

threaded thermocouples standard

with socket with thread M8x1

SIT

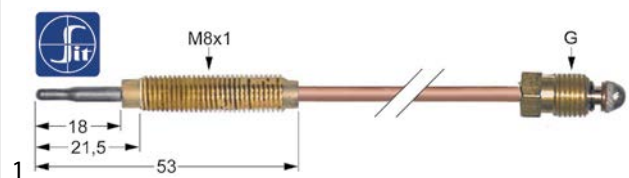

Part No.	107628	Ref. No.	C5811019
description	thermocouple SIT M8x1 L 320mm M8x1		
For models:	3015, 30152, 3300, 3301, 3302, 33022, 33025, 3303, 33035, 3304, 33042, 33052, 3306, 33062, 33092, 3401, 3402, 3404S, 3405S, 3501, 35012, 3501C, 4402, 4402M, 4403, 4403M, 4404, 4404M, 4405, 4405M, 4410, 4411, 4412, 4413, 44138, 4416, 4417, 4422, 4423, 4424, 4425, 4442, 4443, 4444, 4445, 4462, 4471, 4472, 4473		
accessories for	107628		
	Part No.	102067	Ref. No. C5811029
	nut thread M8x1 H 3mm brass Qty 1 pcs type SEF 1		



Part No.	107629	Ref. No.	C5811039
description	thermocouple SIT M8x1 L 450mm M8x1		
For models:	5305, 53054, 5310, 53104, 5315, 53154, 5320, 53204, 5330, 53304, 5340, 53404, 5355, 5360, 53604, 5375, 5380, 53804		
accessories for	107629		
	Part No.	102067	Ref. No. C5811029
nut thread M8x1 H 3mm brass Qty 1 pcs type SEF 1			

Part No.	107636	Ref. No.	C5811849
description	thermocouple SIT M9x1 L 600mm M8x1		
For models:	3411S, 34121S, 3412S-Vers1, 3412S-Vers2, 3413SE1, 34151S, 3415S, 3511SE1, 4930, 49301, 5052S		
accessories for	107636		
	Part No.	102067	Ref. No. C5811029
nut thread M8x1 H 3mm brass Qty 1 pcs type SEF 1			

Part No.	107638	Ref. No.	C5811049
description	thermocouple SIT M9x1 L 1000mm M8x1		
For models:	3401, 3501, 4001		

Part No.	107637	Ref. No.	C5811699
description	thermocouple SIT M9x1 L 850mm M8x1		
accessories for	107637		
	Part No.	102067	Ref. No. C5811029
nut thread M8x1 H 3mm brass Qty 1 pcs type SEF 1			

Part No.	107640	Ref. No.	C5811109
description	thermocouple SIT M9x1 L 1500mm M8x1		

type Junkers with aluminised tip

Part No.	102233	Ref. No.	C5811129
description	thermocouple M8x1 L 750mm M8x1		
For models:	3401, 3402, 3404S, 3405S		
accessories for	102233		
	Part No.	102067	Ref. No. C5811029
nut thread M8x1 H 3mm brass Qty 1 pcs type SEF 1			

Part No.	107635	Ref. No.	C5811739
description	thermocouple SIT M9x1 L 320mm M8x1		
For models:	3331, 4437, 4920, 49201, 49202		
accessories for	107635		
	Part No.	102067	Ref. No. C5811029
nut thread M8x1 H 3mm brass Qty 1 pcs type SEF 1			

accessories

nuts

Part No.	102067	Ref. No.	C5811029
description	nut thread M8x1 H 3mm brass Qty 1 pcs type SEF 1		
For models:	30152, 3300, 3301, 33022, 33042, 33052, 33062, 33092, 35012, 4402, 4402M, 4403, 4403M, 4404, 4404M, 4405, 4405M, 4410, 4411, 4412, 4413, 44138, 4416, 4417, 4422, 4423, 4424, 4425, 4442, 4443, 4444, 4445, 4462, 4471, 4472, 4473, 5305, 53054, 5310, 53104, 5315, 53154, 5320, 53204, 5330, 53304, 5336, 5340, 53404, 5348...(Other models you can see in the webshop)		



gas burners

hob burners

universal hob burners

ARC

65 series



Part No.	104328	Ref. No.	C5815139
description	burner pipe 4.5kW L 93mm total length 108mm air mixer ø 18.2mm ED ø 32.9mm ID ø 22.7mm		
For models:	3015, 3302, 33025, 3303, 33035, 3304, 3306, 3401, 3402, 3404S, 3405S, 3501, 3501C, 3504, 3592, 4001		

SABAF

1 series



Part No.	104288	Ref. No.	C5815589
description	burner cap 3.6kW ø 120mm		
For models:	30152, 33022, 33042, 33052, 33092, 35012, 4410, 4411, 4412, 4413, 44138, 4416, 4417		

accessories for	104288			
	Part No.	104289	Ref. No.	C5815609
	burner lower part 3/3.6kW for burner cap ø 90/120mm			
	Part No.	105086	Ref. No.	C5815579
	burner ring 3.6kW for burner cap ø 120mm			
	Part No.	105087	Ref. No.	C5815599
	burner head 3.6kW for burner cap ø 120mm			



Part No.	105087	Ref. No.	C5815599
description	burner head 3.6kW for burner cap ø 120mm		
For models:	30152, 33022, 33042, 33052, 33092, 35012, 4410, 4411, 4412, 4413, 44138, 4416, 4417		

accessories for	105087			
	Part No.	104288	Ref. No.	C5815589
	burner cap 3.6kW ø 120mm			
	Part No.	105085	Ref. No.	—
	burner cap ø 120mm			
	Part No.	105086	Ref. No.	C5815579
	burner ring 3.6kW for burner cap ø 120mm			
	Part No.	105088	Ref. No.	—
	burner cap A ø 110mm with central hole			

accessories for	105087			
	Part No.	105089	Ref. No.	—
	burner ring 3kW for burner cap ø 90mm			

	Part No.	104289	Ref. No.	C5815609
	burner lower part 3/3.6kW for burner cap ø 90/120mm			
For models:	30152, 33022, 33042, 33052, 33092, 35012, 4410, 4411, 4412, 4413, 44138, 4416, 4417			
accessories for	104289			
	Part No.	104286	Ref. No.	—
	burner cap 3kW ø 90mm			
	Part No.	104288	Ref. No.	C5815589
	burner cap 3.6kW ø 120mm			
	Part No.	105086	Ref. No.	C5815579
	burner ring 3.6kW for burner cap ø 120mm			
	Part No.	105087	Ref. No.	C5815599
	burner head 3.6kW for burner cap ø 120mm			
	Part No.	105089	Ref. No.	—
	burner ring 3kW for burner cap ø 90mm			
	Part No.	105090	Ref. No.	—
	burner head 3kW for burner cap ø 90mm			
	Part No.	106482	Ref. No.	—
	gas injector thread M6x0.75 WS 7 bore ø 1.1mm			
	Part No.	106485	Ref. No.	—
	gas injector thread M6x0.75 WS 7 bore ø 1.6mm			

	Part No.	105086	Ref. No.	C5815579
	burner ring 3.6kW for burner cap ø 120mm			
For models:	30152, 33022, 33042, 33052, 33092, 35012, 4410, 4411, 4412, 4413, 44138, 4416, 4417			
accessories for	105086			
	Part No.	105085	Ref. No.	—
	burner cap ø 120mm			
	Part No.	105087	Ref. No.	C5815599
	burner head 3.6kW for burner cap ø 120mm			
	Part No.	105088	Ref. No.	—
	burner cap A ø 110mm with central hole			
	Part No.	105089	Ref. No.	—
	burner ring 3kW for burner cap ø 90mm			



accessories

pan supports



1			
Part No.	210029	Ref. No.	31440000
description	pan support W 347mm L 397mm H 43mm suitable for MACFRIN		

tube burners



1			
Part No.	104414	Ref. No.	C5815399
description	tubular burner ø 74mm L 180mm thread 3/8" H 52mm ID ø 25mm W 74mm		
For models:	3026, 3027, 3027V		

ceramic burners



1			
Part No.	101938	Ref. No.	530587M 534030P
description	ceramic burner L 845mm W 86mm firing range 61x801mm chicken rotisserie		
For models:	5305, 53054, 5310, 53104, 5315, 53154, 5320, 53204, 5330, 53304, 5340, 53404, 5355, 5360, 53604, 5375, 5380, 53804		

gas nozzles

main nozzles

gas nozzles M10x1

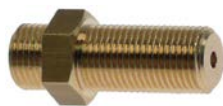

1			
Part No.	107827	Ref. No.	C5812660
description	gas injector thread M10x1 WS 12 bore ø 1.45mm GN		
For models:	4815, 4920, 49201, 49202, 4930, 49301, 5051, 5052S		



1			
Part No.	107828	Ref. No.	C5812680
description	gas injector thread M10x1 WS 12 bore ø 1.9mm GLP		
For models:	4815, 4920, 49201, 49202, 4930, 49301, 5051, 5052S, 5315, 5320, 5330, 5336, 5340, 5348, 5355, 5372, 5375, 5396, 5424, 5436, 5448, 5496		



1			
Part No.	107826	Ref. No.	C5812640
description	gas injector thread M10x1 WS 12 bore ø 1mm GLP		
For models:	4815, 4920, 49201, 49202, 4930, 49301, 5051, 5052S		



1			
Part No.	107829	Ref. No.	C5812689
description	gas injector thread M10x1 WS 12 bore ø 2.2mm GN		
For models:	4930, 49301, 5051, 5052S		

pilot burner nozzles

pilot burner nozzles POLIDORO



1			
Part No.	100000	Ref. No.	C5810169
description	pilot burner nozzle POLIDORO LPG code 22 bore ø 0.22mm Qty 1 pcs		
For models:	3001, 3003, 3005, 3013, 3014, 3026, 3027, 3027V, 3401, 3402, 3501, 3592, 3607, 3611S, 3614S, 3624, 3628H, 3628S, 3683S, 3684S, 3907, 3908, 3911, 3912, 4001, 4701S, 4702, 4703, 4704, 4801, 4803, 4803E, 4805, 4807, 4811, 4812, 4812E, 4815, 4817, 4903, 4907, 4999		



1			
Part No.	106703	Ref. No.	C5810159
description	pilot burner nozzle POLIDORO natural gas code 27.2 bore ø 2x0.27mm Qty 1 pcs		
For models:	3001, 3003, 3005, 3013, 3014, 3026, 3027, 3027V, 3401, 3402, 3501, 3592, 3607, 3611S, 3614S, 3624, 3628H, 3628S, 3683S, 3684S, 3907, 3908, 3911, 3912, 4001, 4701S, 4702, 4703, 4704, 4801, 4803, 4803E, 4805, 4807, 4811, 4812, 4812E, 4815, 4817, 4903, 4907, 4999		

1 gas components



auxiliary gas parts

screw connections

olives



Part No.	101278	Ref. No.	3781
description	olive for pipe ø 10mm Qty 1 pcs		
For models:	3001, 3003, 30032, 3005, 3013, 30132, 3014, 30142, 3015, 3026, 3027, 3027V, 3302, 33025, 3303, 33035, 3304, 3306, 3331, 3401, 3402, 3404S, 3405S, 3411S, 34121S, 3412S-Vers1, 3412S-Vers2, 3413SE1, 34151S, 3415S, 3501, 3501C, 3504, 3511SE1, 3592, 3607, 3611S, 3614S, 3624, 3628H, 3628S, 3683S, 3684S, 3907, 3908, 3911, 3912, 4001, 4404, 4404M...(Other models you can see in the webshop)		
accessories for	101278		
	Part No.	100943	Ref. No. —
description	union nut thread M17x1 tube ø 10mm		
	Part No.	101300	Ref. No. 3782
description	union nut thread M16x1.5 tube ø 10mm		
	Part No.	101478	Ref. No. —
description	union nut thread 3/8" for pipe ø 10mm		

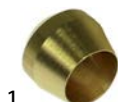

Part No.	102797	Ref. No.	A1018999
description	olive for pipe ø 6mm Qty 1 pcs		
For models:	3001, 3003, 3005, 3013, 3014, 3026, 3027, 3401, 3402, 3501, 3592, 3607, 3611S, 3614S, 3624, 3628H, 3628S, 3683S, 3684S, 3907, 3908, 3911, 3912, 4001, 4701S, 4702, 4703, 4704, 4801, 4803, 4803E, 4805, 4807, 4811, 4812, 4812E, 4815, 4817, 4903, 4907, 4999		

union nuts



Part No.	101296	Ref. No.	C5815539
description	union nut thread M12x1 for pipe ø 8mm		
For models:	3300, 3301, 33062		
accessories for	101296		
	Part No.	101277	Ref. No. C5815549
description	olive ID ø 8mm Qty 1 pcs		



Part No.	101300	Ref. No.	3782
description	union nut thread M16x1.5 tube ø 10mm		
For models:	3001, 3003, 30032, 3005, 3013, 30132, 3014, 30142, 3015, 3026, 3027, 3027V, 3302, 33025, 3303, 33035, 3304, 3306, 3331, 3401, 3402, 3404S, 3405S, 3411S, 34121S, 3412S-Vers1, 3412S-Vers2, 3413SE1, 34151S, 3415S, 3501, 3501C, 3504, 3511SE1, 3592, 3607, 3611S, 3614S, 3624, 3628H, 3628S, 3683S, 3684S, 3907, 3908, 3911, 3912, 4001, 4404, 4404M...(Other models you can see in the webshop)		
accessories for	101300		
	Part No.	101278	Ref. No. 3781
description	olive for pipe ø 10mm Qty 1 pcs		

union screws



Part No.	100905	Ref. No.	C5815359
description	locking screw M10x1 for pipe ø 6mm Qty 1 pcs		
For models:	3001, 3003, 3005, 3013, 3014, 3015, 3026, 3027, 3027V, 3302, 33025, 3303, 33035, 3304, 3306, 3331, 3401, 3402, 3404S, 3405S, 3411S, 34121S, 3412S-Vers1, 3412S-Vers2, 3413SE1, 34151S, 3415S, 3501, 3501C, 3504, 3511SE1, 3592, 3607, 3611S, 3614S, 3624, 3628H, 3628S, 3683S, 3684S, 3907, 3908, 3911, 3912, 4437, 4701S, 4702, 4703, 4704, 4801...(Other models you can see in the webshop)		



Part No.	100906	Ref. No.	A1018998
description	screw connection thread M10x1 for ignition electrode brass Qty 1 pcs WS 10		
For models:	3001, 3003, 3005, 3013, 3014, 3026, 3027, 3027V, 3401, 3402, 3501, 3592, 3607, 3611S, 3614S, 3624, 3628H, 3628S, 3683S, 3684S, 3907, 3911, 3912, 4001, 4701S, 4702, 4703, 4704, 4801, 4803, 4803E, 4805, 4807, 4811, 4812, 4812E, 4815, 4817, 4903, 4907, 4999		



Part No.	100907	Ref. No.	A1018996
description	screw connection thread M10x1 Qty 1 pcs type SEF 1 ømm for thermocouple		
For models:	3001, 3003, 3005, 3013, 3014, 3026, 3027, 3027V, 3401, 3402, 3501, 3592, 3607, 3611S, 3614S, 3624, 3628H, 3628S, 3683S, 3684S, 3907, 3908, 3911, 3912, 4001, 4701S, 4702, 4703, 4704, 4801, 4803, 4803E, 4805, 4807, 4811, 4812, 4812E, 4815, 4817, 4903, 4907, 4999		



 <p>1</p>			
Part No.	100909	Ref. No.	A1018997
description	union screw thread M10x1 for pipe ø 6mm Qty 1 pcs		
For models:	3001, 3003, 3005, 3013, 3014, 3026, 3027, 3027V, 3401, 3402, 3501, 3592, 3607, 3611S, 3614S, 3624, 3628H, 3628S, 3683S, 3684S, 3907, 3908, 3911, 3912, 4001, 4701S, 4702, 4703, 4704, 4801, 4803, 4803E, 4805, 4807, 4811, 4812, 4812E, 4815, 4817, 4903, 4907, 4999		
accessories for	100909		
	Part No.	100898	Ref. No. —
	olive for pipe ø 6mm Qty 1 pcs for pilot burner		
	Part No.	101286	Ref. No. —
	olive ID ø 6mm Qty 1 pcs		
	Part No.	101287	Ref. No. —
	olive for pipe ø 6mm Qty 1 pcs		
	Part No.	101288	Ref. No. —
	olive for pipe ø 6mm L 6mm aluminium Qty 1 pcs ED ø 8.5mm		

equipment-specific units



for chicken rotisserie

skewers

 <p>1</p>			
Part No.	689000	Ref. No.	70290029
description	skewer square L 835mm thickness 12mm		
For models:	5305, 53054, 5310, 53104, 5315, 53154, 5320, 53204, 5330, 53304, 5340, 53404, 5355, 5360, 53604, 5375, 5380, 53804		

spit clamp

 <p>1</p>			
Part No.	693143	Ref. No.	7024D001
description	skewer clamp crimping range 13x13mm ² double for skewer 12x12mm mounting pos. inner skewer 2x60mm skewer ø 4mm		
For models:	10P, 20P, 30P, 40P, 5305, 53054, 5310, 53104, 5315, 53154, 5320, 53204, 5330, 53304, 5340, 53404, 5355, 5360, 53604, 5375, 5380, 53804		

 <p>1</p>			
Part No.	693142	Ref. No.	7024S001
description	skewer clamp single for skewer 12x12mm mounting pos. outer skewer 75mm skewer ø 4mm		
For models:	5305, 53054, 5310, 53104, 5315, 53154, 5320, 53204, 5330, 53304, 5340, 53404, 5355, 5360, 53604, 5375, 5380, 53804		
accessories for	693142		
	Part No.	697481	Ref. No. —
	Thumb screw thread M6 thread L 8mm ø 14mm H 6mm SS		

handles and hand wheels

hand wheels

hand wheels

 <p>1</p>			
Part No.	694357	Ref. No.	C6262619
description	hand wheel ø 200mm D1 ø 50mm bore ø 15mm hole ø 7.2mm thread groove widthmm L1 46mm L2 50mm handle length 90mm with folding handle		
For models:	4812, 4812E, 4817		

bracket handles

 <p>1</p>			
Part No.	697944	Ref. No.	70491019
description	handle L 150mm H 38mm mounting distance 135mm thread M6 W 30mm black matt		
For models:	5301, 5302, 5305, 53054, 5310, 53104, 5315, 53154, 5320, 53204, 5330, 53304, 5336, 5340, 53404, 5348, 5355, 5360, 53604, 5372, 5375, 5380, 53804, 5396, 5424, 54244, 5436, 54364, 5448, 54484, 5453, 5496, 6190, 6190E1, 9001, 9002, 9003		



hinges

spring assisted hinges

producer-specific

CORECO



Part No.	700830	Ref. No.	C6262001
description	spring assisted hinge right/left L 75mm W 26mm H 102mm refrigeration units mounting distance 25mm		
For models:	6190, 6190E1, 7050, 70501, 7052, 706, 7062, 7460, 7464, 7500, 7502, 75021, 7530, 7535, 75351, 9001, 9002, 9003		
accessories for	700830		
	Part No.	700854	Ref. No. —

FAGOR



Part No.	700830	Ref. No.	C6262001
description	spring assisted hinge right/left L 75mm W 26mm H 102mm refrigeration units mounting distance 25mm		
For models:	6190, 6190E1, 7050, 70501, 7052, 706, 7062, 7460, 7464, 7500, 7502, 75021, 7530, 7535, 75351, 9001, 9002, 9003		
accessories for	700830		
	Part No.	700854	Ref. No. —

oven hinges

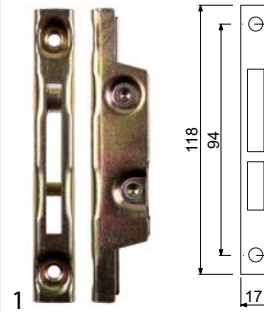

Part No.	700001	Ref. No.	61980
description	opposite support L 118mm W 17mm mounting distance 94mm		
For models:	3300, 3301, 3302, 33022, 3310, 3401, 3402, 3481, 3483, 3501, 35012, 3592, 3628H, 4001, 4409, 4410, 4815, 4901, 4902, 4903, 4904, 4907, 4908, 4999		



Part No.	694359	Ref. No.	6160 C6262599
description	oven hinge mounting distance 105mm lever length 129.5mm spring thickness 4mm mounting ear position right L 206mm W 25mm Qty 1 pcs		
For models:	3300, 3302, 33022, 3310, 3401, 3402, 3481, 3483, 3501, 35012, 3592, 3628H, 4001, 4409, 4410, 4815, 4901, 4902, 4903, 4904, 4907, 4908, 4999		



Part No.	694360	Ref. No.	6163 C6262609
description	oven hinge mounting distance 173mm mounting distance 2 105mm lug mounting 14mm lever length 119mm groove distance 11mm spring thickness 4mm mounting ear position left spring length 111mm L 206mm W 25mm		
For models:	3300, 3302, 33022, 3310, 3401, 3402, 3481, 3483, 3501, 35012, 3592, 3628H, 4001, 4409, 4410, 4815, 4901, 4902, 4903, 4904, 4907, 4908, 4999		



door bearing



1

Part No.	694358	Ref. No.	C6262002
description	bolt L 25mm W 25mm H 19mm ID ø 7mm for hinge		
For models:	7050, 70501, 7052, 706, 7062, 7460, 7464, 7500, 7502, 75021		



1

Part No.	694361	Ref. No.	706203P
description	hinge L 100mm W 48mm mounting pos. centre left/right		
For models:	7050, 70501, 7052, 706, 7062, 7460, 7464, 7500, 7502, 75021		



1

Part No.	694034	Ref. No.	705003P
description	hinge right/left mounting pos. lower for fridge L 130mm W 80mm		
For models:	7050, 70501, 7052, 706, 7062, 7460, 7464, 7500, 7502, 75021, 7530, 7535, 75351		



1

Part No.	694033	Ref. No.	706003P
description	hinge right/left mounting pos. upper for fridge L 130mm W 80mm		
For models:	7050, 70501, 7052, 706, 7062, 7460, 7464, 7500, 7502, 75021, 7530, 7535, 75351, 9001, 9002, 9003		

fittings for catering equipment

lid hinges

type RUBINETTERIE DEL FRIULI

for square and rectangular lids

spare parts



1

Part No.	540848	Ref. No.	C6260349
description	torsion spring ø 43mm wire gauge ø 5mm L1 25mm L2 90mm L3 25mm mounting pos. left		
For models:	4801, 4803, 4803E, 4805, 4807, 4808, 4811, 4812, 4812E, 4817		



1

Part No.	540849	Ref. No.	C6260339
description	torsion spring ø 43mm wire gauge ø 5mm L1 25mm L2 90mm L3 25mm mounting pos. right		
For models:	4801, 4803, 4803E, 4805, 4807, 4808, 4811, 4812, 4812E, 4817		

miscellaneous

spare parts



1

Part No.	514418	Ref. No.	C6260239
description	adjusting bush ID ø 47mm ED ø 50mm L 63.5mm		
For models:	4801, 4803, 4803E, 4805, 4807, 4808, 4811, 4812, 4812E, 4817		



1

Part No.	514194	Ref. No.	481240P
description	bracket for lid hinge ID ø 50mm H 89mm		
For models:	4812, 4812E, 4817		





Part No.	514193	Ref. No.	480340P
description	bracket for lid hinge ID ø 51mm H 185mm		
For models:	4801, 4803, 4803E, 4805, 4807, 4808, 4811		

gaskets for heated units

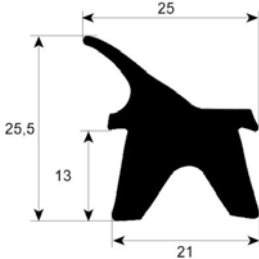
door seals

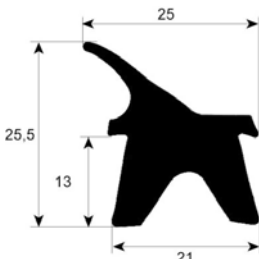

Part No.	901347	Ref. No.	490326P
description	door seal profile 2402 W 350mm L 575mm external size Qty 1		
For models:	3300, 3301, 3302, 33022, 3310, 3401, 3402, 3481, 3483, 3501, 35012, 4409, 4410, 4815, 4901, 4902, 4903, 4904, 4907, 4908		



Part No.	901348	Ref. No.	499926P
description	door seal profile 2402 W 350mm L 985mm external size Qty 1		
For models:	3402, 3592, 3628H, 4999		

O-rings

EPDM

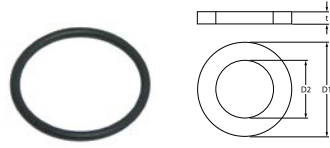

Part No.	100809	Ref. No.	3785
description	O-ring EPDM thickness 2mm ID ø 21mm Qty 1 pcs		
For models:	3001, 3003, 3005, 3026, 3027, 3027V, 3401, 3402, 3501, 3592, 3607, 3611S, 3614S, 3624, 3628H, 3628S, 3683S, 3684S, 3907, 3908, 4812, 4812E, 4815, 4817, 4903, 4907, 4999		

gaskets

refrigeration gaskets

plug-in gaskets

profile 9798

We offer custom-made gaskets for this profile

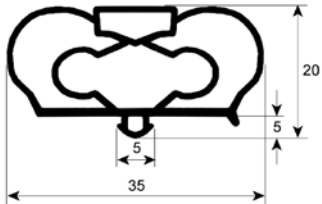

Part No.	901349	Ref. No.	705226P
description	refrigeration gasket profile 9798 W 602mm L 704mm plug size		
For models:	7050, 70501, 7052, 706, 7062, 7460, 7464, 7500, 7502, 75021		

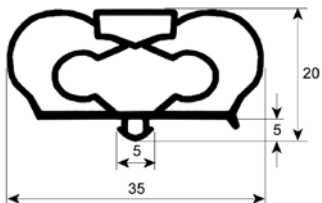

Part No.	901350	Ref. No.	746226P
description	refrigeration gasket profile 9798 W 604mm L 1492mm plug size		
For models:	7460, 7464, 7500, 7502, 75021, 7530, 7535, 75351		





springs

torsion springs

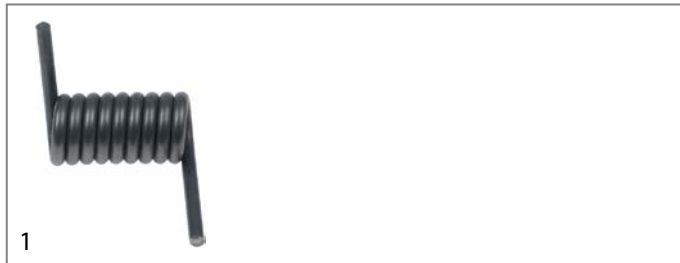

Part No.	692179	Ref. No.	6409
description	torsion spring ø 22.3mm L2 45mm wire gauge ø 4.5mm mounting pos. left L1 45mm L3 52mm Qty 1 pcs		
For models:	4401, 4462		
accessories for	692179		
	Part No.	692178	Ref. No. 6407
	torsion spring ø 22.3mm L2 45mm wire gauge ø 4.5mm mounting pos. right L1 45mm L3 52mm Qty 1 pcs		



Part No.	692178	Ref. No.	6407
description	torsion spring ø 22.3mm L2 45mm wire gauge ø 4.5mm mounting pos. right L1 45mm L3 52mm Qty 1 pcs		
For models:	4401, 4462		
accessories for	692178		
	Part No.	692179	Ref. No. 6409
	torsion spring ø 22.3mm L2 45mm wire gauge ø 4.5mm mounting pos. left L1 45mm L3 52mm Qty 1 pcs		

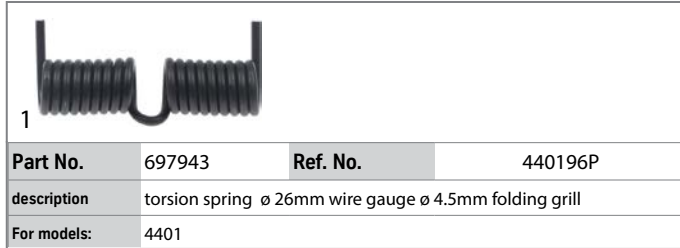

Part No.	697943	Ref. No.	440196P
description	torsion spring ø 26mm wire gauge ø 4.5mm folding grill		
For models:	4401		

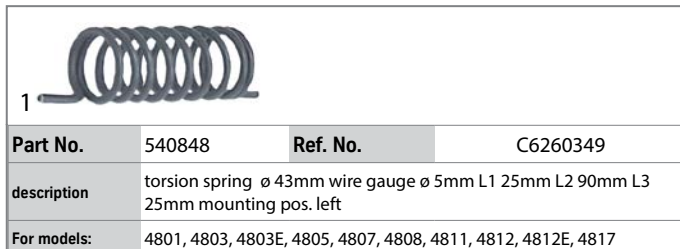

Part No.	540848	Ref. No.	C6260349
description	torsion spring ø 43mm wire gauge ø 5mm L1 25mm L2 90mm L3 25mm mounting pos. left		
For models:	4801, 4803, 4803E, 4805, 4807, 4808, 4811, 4812, 4812E, 4817		



Part No.	540849	Ref. No.	C6260339
description	torsion spring ø 43mm wire gauge ø 5mm L1 25mm L2 90mm L3 25mm mounting pos. right		
For models:	4801, 4803, 4803E, 4805, 4807, 4808, 4811, 4812, 4812E, 4817		

fastening material

screws

flat-headed bolts



Part No.	101516	Ref. No.	1051
description	flat-headed bolt thread M4 thread L 16mm SS DIN 7985/ISO 7045 Qty 1 pcs		
For models:	3001, 3003, 3005, 3026, 3027, 3027V, 3331, 3401, 3402, 3411S, 34121S, 3412S-Vers1, 3412S-Vers2, 3413SE1, 34151S, 3415S, 3501, 3592, 3607, 3611S, 3614S, 3624, 3628H, 3628S, 3683S, 3684S, 3907, 3908, 4812, 4812E, 4815, 4817, 4903, 4907, 4999		

nuts

hexagonal nuts

hexagonal nuts metric (without norm)

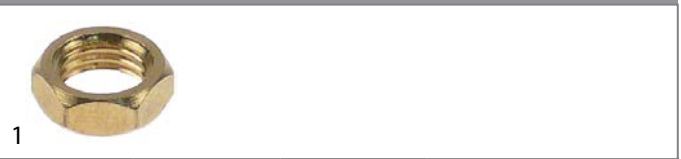

Part No.	102680	Ref. No.	C5815299
description	nut thread M6x0.75 H 2.6mm WS 8 brass Qty 1 pcs type SEF 2		
For models:	3401, 3402, 3501, 3504, 3592, 4001		



Part No.	102067	Ref. No.	C5811029
description	nut thread M8x1 H 3mm brass Qty 1 pcs type SEF 1		
For models:	30152, 3300, 3301, 33022, 33042, 33052, 33062, 33092, 35012, 4402, 4402M, 4403, 4403M, 4404, 4404M, 4405, 4405M, 4410, 4411, 4412, 4413, 44138, 4416, 4417, 4422, 4423, 4424, 4425, 4442, 4443, 4444, 4445, 4462, 4471, 4472, 4473, 5305, 53054, 5310, 53104, 5315, 53154, 5320, 53204, 5330, 53304, 5336, 5340, 53404, 5348...(Other models you can see in the webshop)		

1 mechanical components, equipment accessories

GASTROPARTS.COM

