



**GASTROPARTS**

# Bertos

- [EN]** Equipment
- [DE]** Geräte
- [ES]** Aparatos
- [FR]** Équipement
- [IT]** Attrezzature
- [PL]** Urządzenia
- [RU]** Оборудование

✉ [gastroparts@gastroparts.com](mailto:gastroparts@gastroparts.com)

☎ +48 56 657 00 66

📘 [fb.com/gastroparts.global](https://fb.com/gastroparts.global)

**GASTROPARTS.COM**





## heating elements

### heating elements for ovens

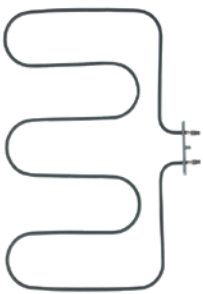

1

<b>Part No.</b>	416042	<b>Ref. No.</b>	22016700
<b>description</b>	heating element 1500W 230V heating circuits 1 L 365mm W 500mm L1 45mm L2 315mm W1 240mm W2 30mm flange length 100mm flange width 22mm hole distance 86mm hole $\varnothing$ 5mm tube $\varnothing$ 6.3mm connection male faston 6.3mm mounting pos. lower rectangular flange dry heating element oven		
<b>For models:</b>	G4S+FCGN, G6S+FCGN		

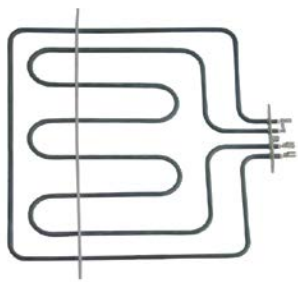

1

<b>Part No.</b>	416041	<b>Ref. No.</b>	22016900
<b>description</b>	heating element 2600W 230V heating circuits 2 L 350mm W 355mm L1 36mm L2 314mm W1 147mm W2 60mm flange length 100mm flange width 22mm hole distance 80mm bridge length 480mm hole $\varnothing$ 5mm tube $\varnothing$ 6.3mm connection male faston 6.3mm mounting pos. upper rectangular flange dry heating element oven		
<b>For models:</b>	G4S+FCGN, G6S+FCGN		

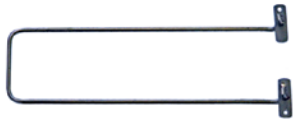



1

<b>Part No.</b>	415294	<b>Ref. No.</b>	31320000
<b>description</b>	heating element 900W 230V L 468mm W 112mm H 23mm lug length 60mm lug width 20mm hole distance 153mm hole $\varnothing$ 6mm tube $\varnothing$ 6.3mm heating circuits 1 dry heating element windings 1 rectangular flange oven		
<b>For models:</b>	E7P4+FE, E7P4+FES, E7P4-VTR+FE, E7P6+FE, E7P6+FES, E7PQ4+FE, E7PQ4+FE+T, E7PQ4+FES, E7PQ6+FE, E7PQ6+FE+T, E7PQ6+FES, E7TP+FE, E9P4+FE, E9P4+FES, E9P4P-VTR+FE, E9P4-VTR+FE, E9P4-VTR+FES, E9P6+FE, E9P6+FES, E9PQ4+FE, E9PQ4+FE+T, E9PQ4+FES, E9PQ6+FE, E9PQ6+FE+T, E9PQ6+FES, G7F4+FE, G7F4+FES, G7F4E+FE, G7F4E+FE+A4, G7F4PW+FE, G7F4PW+FE+AE, G7F6+FE, G7F6+FES, G7F6E+FE, G7F6E+FE+A6, G7F6PW+FE, G7F6PW+FE+AE, G9F4+FE, G9F4PW+FE, G9F4PW+FE+AE, G9F6+FE, G9F6PW+FE, G9F6PW+FE+AE, G9F8+2FE, SE9P4P-VTR+FE, SE9PQ4+FE, SE9PQ6+FE, SG9F4+FE, SG9F6+FE, SG9F8+2FE		

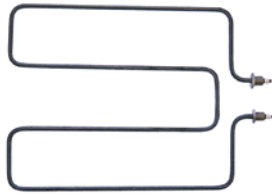
### heating elements for bain maries



1

<b>Part No.</b>	415844	<b>Ref. No.</b>	22015800	
<b>description</b>	heating element 2600W 230V heating circuits 1 L 410mm W 300mm connection length 10mm connection M4 tube $\varnothing$ 8.5mm 2 hole fixing thread 3/8" immersion heater L1 27mm L2 383mm W1 120mm W2 60mm mounting distance 50mm			
<b>For models:</b>	EBMM6			
<b>spare parts for</b>	415844			
	<b>Part No.</b>	521137	<b>Ref. No.</b>	—
	flat gasket fibre ED $\varnothing$ 20mm ID $\varnothing$ 18mm thickness 1.5mm for thread 3/8" Qty 1 pcs			
<b>accessories for</b>	415844			
	<b>Part No.</b>	361183	<b>Ref. No.</b>	—
	nut thread 3/8" H 6mm nickel-plated brass WS 20 Qty 1 pcs			

### heating elements for chip scuttles



1

<b>Part No.</b>	416082	<b>Ref. No.</b>	22016400
<b>description</b>	heating element 350W 230V heating circuits 8.5 L 172mm W 74mm flange length 110mm flange width 22mm hole distance 94mm connection length 20mm connection male faston 6.3mm tube $\varnothing$ 8.5mm rectangular flange hole $\varnothing$ 6mm dry heating element		
<b>For models:</b>	ESPS4		

### heating elements for fryers

#### off-center connection

#### miscellaneous



1

<b>Part No.</b>	417764	<b>Ref. No.</b>	38927800	
<b>description</b>	heating element 18000W 230V heating circuits 3 L 332mm W 265mm H 33mm flange length 48mm flange $\varnothing$ 1 58mm flange $\varnothing$ 2 54mm thermostat sleeves $\varnothing$ 6.5mm sensor screw connection 2x M10x1 thermostat sleeve upper/lower L1 17mm L2 315mm W1 33mm W2 35mm tube $\varnothing$ 8.5mm cable length 550mm rotation flange fryer			
<b>accessories for</b>	417764			
	<b>Part No.</b>	529186	<b>Ref. No.</b>	45354800 45854800
	O-ring Viton thickness 3.53mm ID $\varnothing$ 47.63mm Qty 1 pcs			



<b>1</b>			
<b>Part No.</b>	416008	<b>Ref. No.</b>	33026600
<b>description</b>	heating element 5000W 230/400V heating circuits 3 L 245mm W 200mm H 170mm H1 143mm H2 27mm rectangular flange connection male faston 6.3mm fryer heaters hole distance 60mm hole ø 5mm flange length 270mm flange width 25mm tube ø 8.5mm		
<b>For models:</b>	ELT10+10B-E, ELT10B-E, ELT12+12B-E, ELT12B-E, ELT15+15B, ELT15+15B-E, ELT15B, ELT15B-E, ELT18+18B, ELT18+18BE, ELT18B, ELT18BE		

<b>1</b>			
<b>Part No.</b>	418104	<b>Ref. No.</b>	33026700
<b>description</b>	heating element 6000W 230/400V heating circuits 3 L 280mm W 205mm H 175mm H1 150mm H2 25mm rectangular flange connection male faston 6.3mm immersion heater hole distance 60.5mm hole ø 5mm flange length 270mm flange width 24mm tube ø 8.5mm		
<b>For models:</b>	ELT10+10B-E, ELT10B-E, ELT12+12B-E, ELT12+12M-E, ELT12B-E, ELT12M-E, ELT15+15B, ELT15+15B-E, ELT15+15M, ELT15+15M-E, ELT15B, ELT15B-E, ELT15M, ELT15M-E, ELT18+18B, ELT18+18BE, ELT18+18M, ELT18+18M-E, ELT18+18M-E224, ELT18B, ELT18BE, ELT18M, ELT18M-E		

<b>1</b>			
<b>Part No.</b>	418106	<b>Ref. No.</b>	33026900
<b>description</b>	heating element 9000W 230/400V heating circuits 3 L 300mm W 240mm H 200mm H1 175mm H2 25mm rectangular flange connection male faston 6.3mm fryer heaters hole distance 85mm hole ø 5mm flange length 325mm flange width 25mm tube ø 8.5mm		
<b>For models:</b>	ELT10+10B-E, ELT10B-E, ELT12+12B-E, ELT12+12M-E, ELT12B-E, ELT12M-E, ELT15+15B, ELT15+15B-E, ELT15+15M, ELT15+15M-E, ELT15B, ELT15B-E, ELT15M, ELT15M-E, ELT18+18B, ELT18+18BE, ELT18+18B-E, ELT18+18M, ELT18+18M-E, ELT18+18M-E224, ELT18B, ELT18BE, ELT18B-E, ELT18M, ELT18M-E		

<b>1</b>			
<b>Part No.</b>	417765	<b>Ref. No.</b>	31016600
<b>description</b>	heating element 13050W 230V heating circuits 3 L 370mm W 230mm H 250mm L1 65mm L2 305mm W1 55mm W2 135mm H1 215mm H2 32mm flange ø 40mm rotation flange cable length 400mm fryer heaters mounting ø 25mm		
<b>For models:</b>	E7F18-4M, E7F18-8M		

<b>1</b>			
<b>Part No.</b>	415257	<b>Ref. No.</b>	22016200
<b>description</b>	heating element 6000W 230/400V heating circuits 3 L 300mm W 182mm H 252mm L1 65mm L2 235mm W1 59mm W2 134mm W3 250mm H1 220mm H2 32mm windings 12 flange ø 40mm rotation flange cable length 380mm fryer heaters mounting ø 25mm		
<b>For models:</b>	E10+10MB6, E10B4, E6F10-3B, E6F10-3M, E6F10-6B, E6F10-6M, E7F10-4B, E7F10-4BS, E7F10-4M, E7F10-4MS, E7F10-8B, E7F10-8BS, E7F10-8M, E7F10-8MS, E7F30-8B, E7F30-8M		

## 2 hole fixing

<b>1</b>			
<b>Part No.</b>	416004	<b>Ref. No.</b>	33024700
<b>description</b>	heating element 2700W 230V heating circuits 1 L 240mm W 208mm H 125mm thread 1/4" tube ø 8.5mm windings 4 mounting distance 200mm connection male faston 6.3mm 2 hole fixing immersion heater		
<b>For models:</b>	8+8LB-LD, 8LB-LD, ELT8+8B, ELT8+8B-E, ELT8B, ELT8B-E		
<b>accessories for</b>	416004		
	<b>Part No.</b>	361182	<b>Ref. No.</b> —
	nut thread 1/4" H 5mm nickel-plated brass WS 17 Qty 1 pcs		
	<b>Part No.</b>	510417	<b>Ref. No.</b> —
	flat gasket fibre ED ø 20mm ID ø 14mm thickness 2mm Qty 1 pcs		
	<b>Part No.</b>	520228	<b>Ref. No.</b> —
	tooth lock washer ID ø 15.3mm ED ø 24mm steel Qty 1 pcs for thread M14		
	<b>Part No.</b>	550262	<b>Ref. No.</b> —
	flat gasket copper ED ø 20mm ID ø 14mm thickness 2mm		



<b>Part No.</b>	416006	<b>Ref. No.</b>	33024800
<b>description</b>	heating element 3100W 230V heating circuits 1 L 270mm W 215mm H 131mm thread 1/4" tube ø 8.5mm windings 4 mounting distance 203mm connection male faston 6.3mm 2 hole fixing immersion heater		
<b>For models:</b>	10+10LB-LD, 10LB-LD, ELT10+10B, ELT10B, ELT12+12B, ELT12B		
<b>accessories for</b>	416006		
	<b>Part No.</b>	361182	<b>Ref. No.</b> —
	nut thread 1/4" H 5mm nickel-plated brass WS 17 Qty 1 pcs		
	<b>Part No.</b>	510417	<b>Ref. No.</b> —
	flat gasket fibre ED ø 20mm ID ø 14mm thickness 2mm Qty 1 pcs		
	<b>Part No.</b>	520228	<b>Ref. No.</b> —
	tooth lock washer ID ø 15.3mm ED ø 24mm steel Qty 1 pcs for thread M14		
	<b>Part No.</b>	550262	<b>Ref. No.</b> —
	flat gasket copper ED ø 20mm ID ø 14mm thickness 2mm		

<b>Part No.</b>	416007	<b>Ref. No.</b>	33025600
<b>description</b>	heating element 3500W 230V heating circuits 1 L 290mm W 190mm H 153mm thread 1/4" tube ø 8.5mm windings 4 mounting distance 84mm connection male faston 6.3mm 2 hole fixing connection length 20mm immersion heater		
<b>For models:</b>	12+12LB-LD, 12+12LM-LD, 12LB-LD, 12LM-LD, 15LBZ-LD, 15LMZ-LD, ELT10+10B, ELT10B, ELT12+12B, ELT12+12M, ELT12B, ELT12M		
<b>accessories for</b>	416007		
	<b>Part No.</b>	361182	<b>Ref. No.</b> —
	nut thread 1/4" H 5mm nickel-plated brass WS 17 Qty 1 pcs		
	<b>Part No.</b>	510417	<b>Ref. No.</b> —
	flat gasket fibre ED ø 20mm ID ø 14mm thickness 2mm Qty 1 pcs		
	<b>Part No.</b>	520228	<b>Ref. No.</b> —
	tooth lock washer ID ø 15.3mm ED ø 24mm steel Qty 1 pcs for thread M14		
	<b>Part No.</b>	550262	<b>Ref. No.</b> —
	flat gasket copper ED ø 20mm ID ø 14mm thickness 2mm		

<b>Part No.</b>	416005	<b>Ref. No.</b>	33024900
<b>description</b>	heating element 3450W 230V heating circuits 1 L 260mm W 200mm H 167mm thread 1/4" tube ø 8.5mm windings 4 mounting distance 192mm connection male faston 6.3mm 2 hole fixing connection length 20mm immersion heater fryer		
<b>For models:</b>	ELT8+8B, ELT8+8B-E, ELT8B, ELT8B-E		

<b>Part No.</b>	416003	<b>Ref. No.</b>	33024600
<b>description</b>	heating element 1800W 230V heating circuits 1 L 270mm W 137mm H 150mm L1 25mm L2 245mm thread M14x1.5 mounting distance 128mm tube ø 8.5mm windings 3 1/4" connection male faston 6.3mm dry heating element		
<b>For models:</b>	ELT4+4B, ELT4B		

<b>Part No.</b>	420068	<b>Ref. No.</b>	33025900
<b>description</b>	heating element 3450W 400V heating circuits 1 L 290mm W 180mm H 153mm thread 1/4" tube ø 8.5mm windings 4 mounting distance 172mm connection male faston 6.3mm 2 hole fixing immersion heater/dry heating element fryer		
<b>For models:</b>	12+12LB-LD, 12+12LM-LD, 12LB-LD, 12LM-LD, 15LBZ-LD, 15LMZ-LD, ELT16B, ELT30B		

heating elements for griddles

<b>Part No.</b>	415651	<b>Ref. No.</b>	22039300
<b>description</b>	heating element 1500W 230V heating circuits 1 L 425mm W 72mm H 53mm tube ø 8.5mm L1 22mm connection male faston 6.3mm connection distance 52mm dry heating element		
<b>For models:</b>	E6BR6B, E6BR6M, E7BR4B, E7BR4M, E7FL4B, E7FL4B-CR, E7FL4B-SX, E7FL4M, E7FL4M-CR, E7FL4M-SX, E7FL8B-2, E7FL8B-2-CR, E7FL8B-2-SX, E7FL8M-2, E7FL8M-2-CR, E7FL8M-2-SX, E7FM8B-2, E7FM8M-2, E7FR4B, E7FR4M, E7FR8B-2, E7FR8M-2, EFLD8, EFLD8-CR, EFLM6, EFLM6-2, EFLM6-2-CR, EFLM6-CR, EFLS4, EFLS4-CR, EFM6-2, EFM6-2-CR, EFRM6, EFRM6-CR, EFRS4		





			
<b>Part No.</b>	420521	<b>Ref. No.</b>	22039400 35039500
<b>description</b>	heating element 1600W 230V heating circuits 1 L 428mm W 65mm H 88mm tube ø 8.5mm		
<b>For models:</b>	E7FL4BP, E7FL4BP-CR, E7FL4BP-SX, E7FL4MP, E7FL4MP-CR, E7FL4MP-SX, E7FL8BP-2, E7FL8BP-2-CR, E7FL8BP-2-SX, E7FL8MP-2, E7FL8MP-2-CR, E7FL8MP-2-SX, E7FM8BP-2, E7FM8MP-2, E7FR4BP, E7FR4MP, E7FR8BP-2, E7FR8MP-2, E9BR8, E9BR8-I, LXE9BR8-I, SE9BR8, SE9BR8-I		

			
<b>Part No.</b>	418063	<b>Ref. No.</b>	35039300
<b>description</b>	heating element 1900W 240V heating circuits 1 L 600mm W 65mm H 75mm tube ø 9mm L1 30mm dry heating element		
<b>For models:</b>	E9FL4M, E9FL4M-CPD, E9FL4M-CR, E9FL4M-SX, E9FL8M-2, E9FL8M-2-CPD, E9FL8M-2-CR, E9FL8M-2-SX, E9FM8M-2, E9FR4M, E9FR8M-2		

## heating elements for tilting bratt pan

			
<b>Part No.</b>	416002	<b>Ref. No.</b>	31927000
<b>description</b>	heating element 3000W 240V L 390mm W 120mm H 68mm connection M4 dry heating element heating circuits 1 tube ø 10mm L1 30mm L2 360mm connection distance 103mm		
<b>For models:</b>	E7BR8, E7BR8-I		

			
<b>Part No.</b>	420593	<b>Ref. No.</b>	38416100
<b>description</b>	heating element for tilting bratt pan 1600W 230V L 460mm W 78mm H 95mm connection cable 2000mm heating circuits 1 tube ø 8.5mm		

			
<b>Part No.</b>	415077	<b>Ref. No.</b>	22039800
<b>description</b>	heating element stock pot 1300W 230V L 280mm W 150mm H 40mm connection male faston 6.3mm tilting bratt pan heating circuits 1 tube ø 8.5mm bracket mounting hole distance 142mm hole ø 5mm lug length 25mm lug width 15mm		
<b>For models:</b>	EBRS4		

			
<b>Part No.</b>	420067	<b>Ref. No.</b>	36039300
<b>description</b>	heating element tilting bratt pan 1350W 240V L 360mm W 66mm H 70mm connection male faston 6.3mm dry heating element heating circuits 1 tube ø 8.5mm L1 30mm connection distance 58mm		
<b>For models:</b>	E6BR6B, E6BR6M, E6FL3B, E6FL3BP, E6FL3B-P, E6FL3BP-CR, E6FL3BPSX, E6FL3B-SX, E6FL3M, E6FL3MP, E6FL3M-P, E6FL3MP-CR, E6FL3MPSX, E6FL3M-SX, E6FL6B-2, E6FL6B-2-SX, E6FL6BP-2, E6FL6BP-2-CR, E6FL6BP-2-SX, E6FL6M-2, E6FL6M-2-SX, E6FL6MP-2, E6FL6MP-2-CR, E6FL6MP-2-SX, E6FM6B-2, E6FM6BP-2, E6FM6M-2, E6FM6MP-2, E6FR3B, E6FR3BP, E6FR3M, E6FR3MP, E6FR6B-2, E6FR6BP-2, E6FR6M-2, E6FR6MP-2, E7BR4B, E7BR4M		

## heating elements for contact grills

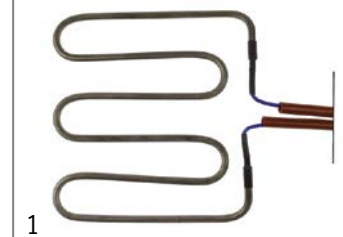
			
<b>Part No.</b>	416011	<b>Ref. No.</b>	30023500
<b>description</b>	heating element 1000W 230V L 182mm W 195mm H 12mm W1 42mm W2 111mm connection length 25mm tube ø 6.3mm windings 3 cable length 400mm dry heating element		
<b>For models:</b>	PDL-LD, PDL-ST, PDL-SX, PDM-LD, PDM-ST, PDR-LD, PDR-ST, PDR-VTR, PDT-L, PDT-LD, PDT-LS, PDT-M, PDT-R, PDT-SX, PDT-VTR, PD-VTR, PSLD, PSL-ST, PSL-SX, PSM-ST, PSR-LD, PSR-ST, PST-L, PST-LD, PST-R		

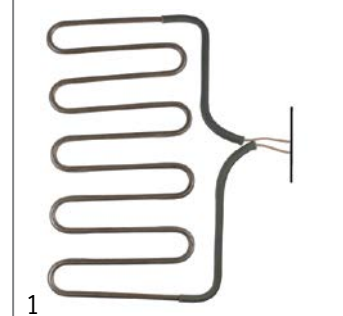
			
<b>Part No.</b>	416013	<b>Ref. No.</b>	30024100
<b>description</b>	heating element 1000W 230V L 185mm W 310mm H 28mm W1 115mm W2 80mm connection length 35mm tube ø 6.9mm windings 5 cable length 690mm dry heating element		
<b>For models:</b>	PM+VTR, PML-LD, PML-ST, PMR-LD, PMR-ST, PMR-VTR, PM-VTR		

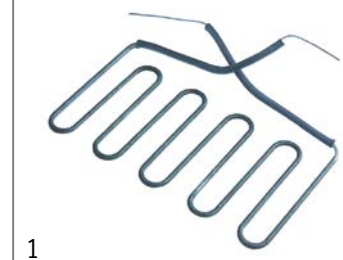
			
<b>Part No.</b>	416014	<b>Ref. No.</b>	30024300
<b>description</b>	heating element 1500W 230V L 180mm W 325mm H 42mm W1 108mm W2 109mm connection length 75mm tube ø 6.3mm windings 5 cable length 330mm dry heating element		
<b>For models:</b>	PM+VTR, PML-LD, PML-ST, PMR-LD, PMR-ST, PMR-VTR, PMT-VTR, PM-VTR		





1

<b>Part No.</b>	416012	<b>Ref. No.</b>	30022500
<b>description</b>	heating element 700W 230V L 185mm W 187mm H 11mm W1 42mm W2 102mm tube ø 6.3mm windings 3 cable length 750mm dry heating element		
<b>For models:</b>	PDL-LD, PDL-ST, PDL-SX, PDM-LD, PDM-ST, PDR-LD, PDR-ST, PDR-VTR, PD-VTR, PSL-LD, PSL-ST, PSL-SX, PSM-ST, PSR-LD, PSR-ST		

heating elements for pasta cookers





1

<b>Part No.</b>	415902	<b>Ref. No.</b>	22015900
<b>description</b>	heating element 2510W 230V L 295mm W 115mm Hmm 2 hole fixing connection male faston 6.3mm thread M14x1 tube ø 8.5mm		
<b>For models:</b>	E6CP6B, E6CP6M, E6CPM, ECRM6		
<b>accessories for</b>	415902		
	<b>Part No.</b>	510417	<b>Ref. No.</b> —
	flat gasket fibre ED ø 20mm ID ø 14mm thickness 2mm Qty 1 pcs		
	<b>Part No.</b>	520228	<b>Ref. No.</b> —
	tooth lock washer ID ø 15.3mm ED ø 24mm steel Qty 1 pcs for thread M14		
	<b>Part No.</b>	521133	<b>Ref. No.</b> —
	nut thread M14x1.5 H 6mm WS 19 zinc-coated steel Qty 1 pcs		
	<b>Part No.</b>	550261	<b>Ref. No.</b> —
	nut thread M14x1 H 4mm WS 19 SS Qty 1 pcs		
	<b>Part No.</b>	550262	<b>Ref. No.</b> —
	flat gasket copper ED ø 20mm ID ø 14mm thickness 2mm		

heating elements for chargrills



1

<b>Part No.</b>	416000	<b>Ref. No.</b>	22039100
<b>description</b>	heating element 1500W 230V L 438mm W 80mm H 62mm thread 1/4" mounting distance 19mm tube ø 8.5mm connection male faston 6.3mm windings 2 heating circuits 1 connection length 23mm 2 hole fixing dry heating element		
<b>For models:</b>	EGRM4, EGRS4		
<b>spare parts for</b>	416000		
	<b>Part No.</b>	510417	<b>Ref. No.</b> —
	flat gasket fibre ED ø 20mm ID ø 14mm thickness 2mm Qty 1 pcs		
<b>accessories for</b>	416000		
	<b>Part No.</b>	361182	<b>Ref. No.</b> —
	nut thread 1/4" H 5mm nickel-plated brass WS 17 Qty 1 pcs		
	<b>Part No.</b>	520228	<b>Ref. No.</b> —
	tooth lock washer ID ø 15.3mm ED ø 24mm steel Qty 1 pcs for thread M14		

<b>accessories for</b>	416000		
	<b>Part No.</b>	550262	<b>Ref. No.</b> —
	flat gasket copper ED ø 20mm ID ø 14mm thickness 2mm		

heating elements for salamanders/toast-

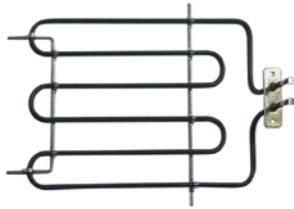

1

<b>Part No.</b>	415347	<b>Ref. No.</b>	27022200 27022300
<b>description</b>	heating element 1600W 230V heating circuits 1 L 295mm W 205mm H 45mm flange length 70mm flange width 22mm hole distance 56mm connection male faston 6.3mm tube ø 6.3mm mounting thread M5 rectangular flange dry heating element		
<b>For models:</b>	SA-E60, SA-E60-E, SA-E68, SA-E68M, SA-E68M-E		

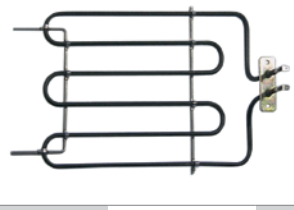

1



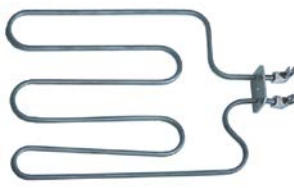

<b>Part No.</b>	416009	<b>Ref. No.</b>	27023000
<b>description</b>	heating element 2300W 230V heating circuits 1 L 300mm W 205mm H 40mm W1 88mm W2 30mm flange length 70mm flange width 22mm hole distance 56mm connection M4 tube ø 6.5mm connection length 8mm mounting thread M4 rectangular flange dry heating element		
<b>For models:</b>	SA-E60, SA-E60-E, SA-E68M, SA-E68M-E		

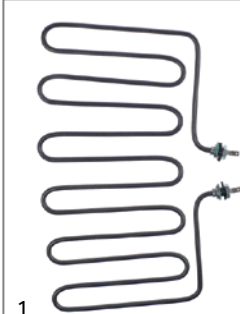

1

<b>Part No.</b>	416010	<b>Ref. No.</b>	30031600
<b>description</b>	heating element 800W 230V heating circuits 1 L 255mm W 169mm L1 40mm L2 185mm W1 70mm W2 29mm flange length 40mm flange width 22mm tube ø 4.2mm connection length 30mm dry heating element connection male faston 6.3mm rectangular flange mounting thread M4		
<b>For models:</b>	4T0		





<b>Part No.</b>	416833	<b>Ref. No.</b>	27022100
<b>description</b>	heating element 2800W 230V L 206mm W 398mm W1 149mm W2 100mm thread 1/4" mounting distance 94mm tube ø 6.3mm connection male faston 6.3mm heating circuits 1 dry heating element 2 hole fixing H 6.3mm		
<b>For models:</b>	SA-E48		
<b>accessories for</b>	416833		
	<b>Part No.</b>	361182	<b>Ref. No.</b> —
	nut thread 1/4" H 5mm nickel-plated brass WS 17 Qty 1 pcs		
	<b>Part No.</b>	510417	<b>Ref. No.</b> —
	flat gasket fibre ED ø 20mm ID ø 14mm thickness 2mm Qty 1 pcs		
	<b>Part No.</b>	520228	<b>Ref. No.</b> —
	tooth lock washer ID ø 15.3mm ED ø 24mm steel Qty 1 pcs for thread M14		
	<b>Part No.</b>	550262	<b>Ref. No.</b> —
	flat gasket copper ED ø 20mm ID ø 14mm thickness 2mm		

## ceramic heaters

245x60mm



<b>Part No.</b>	415103	<b>Ref. No.</b>	22016100
<b>description</b>	ceramic emitter 650W 230V cable beaded cord L 245mm W 60mm H 35mm		
<b>For models:</b>	E6SP6B, E6SP6M, E7SP-4B, E7SP-4M, ESPS4		
<b>spare parts for</b>	415103		
	<b>Part No.</b>	415109	<b>Ref. No.</b> —
	spring clip		
<b>accessories for</b>	415103		
	<b>Part No.</b>	415110	<b>Ref. No.</b> —
	reflector L 245mm W 95mm H 31mm thickness 0.75mm hole ø 15x40mm		

## quartz heating elements



<b>Part No.</b>	416021	<b>Ref. No.</b>	30040800
<b>description</b>	heating coil 500W 110V for quartz tube L1 390mm L2 325mm ø 5mm connection eye		
<b>For models:</b>	12T, 6T		



<b>Part No.</b>	415311	<b>Ref. No.</b>	30014100
<b>description</b>	quartz heating element L 410mm ø 11mm 1000W 230V W 130mm connection eye double inner length 390mm		
<b>For models:</b>	12T, 6T		





<b>Part No.</b>	416020	<b>Ref. No.</b>	30043100
<b>description</b>	quartz tube WW L 390mm ID ø 9mm ED ø 11mm		
<b>For models:</b>	12T, 6T		

## immersion heating elements

3 hole flange ø47.5mm



<b>Part No.</b>	418136	<b>Ref. No.</b>	25021600
<b>description</b>	heating element 4360W 240V mounting ø 47.5mm heating circuits 3 L 310mm W 31mm H 35mm number of thermostat sleeves 1 thermostat sleeves ø 7mm length thermostat sleeves 200mm thermostat sleeve clinging tube ø 6.3mm hole distance 62mm hole ø 8mm connection M4 3 hole flange immersion heater		
<b>For models:</b>	FME06M, FME10, FME10EP, FME10M, FME20, FME20M, FME6		
<b>spare parts for</b>	418136		
	<b>Part No.</b>	510408	<b>Ref. No.</b> 35859500
	O-ring EPDM thickness 5.34mm ID ø 47mm Qty 1 pcs		
<b>accessories for</b>	418136		
	<b>Part No.</b>	510408	<b>Ref. No.</b> 35859500
	O-ring EPDM thickness 5.34mm ID ø 47mm Qty 1 pcs		
	<b>Part No.</b>	510562	<b>Ref. No.</b> —
	O-ring silicone thickness 5.34mm ID ø 47mm Qty 1 pcs		



1

<b>Part No.</b>	418064	<b>Ref. No.</b>	35039900
<b>description</b>	heating element 8000W 230V mounting $\varnothing$ 47.5mm heating circuits 3 L 497mm W 30mm H 36mm number of thermostat sleeves 1 thermostat sleeves $\varnothing$ 7mm length thermostat sleeves 260mm thermostat sleeve clinging tube $\varnothing$ 8.5mm hole distance 63mm hole $\varnothing$ 8mm connection length 16mm connection M4 3 hole flange immersion heater		
<b>For models:</b>	E9P10I, E9P10IA, E9P15I, SE9P10I, SE9P10IA, SE9P15I		
<b>accessories for</b>	418064		
	<b>Part No.</b>	510408	<b>Ref. No.</b> 35859500
	O-ring EPDM thickness 5.34mm ID $\varnothing$ 47mm Qty 1 pcs		
	<b>Part No.</b>	510562	<b>Ref. No.</b> —
	O-ring silicone thickness 5.34mm ID $\varnothing$ 47mm Qty 1 pcs		

1

<b>Part No.</b>	418065	<b>Ref. No.</b>	35040100
<b>description</b>	heating element 9000W 230V mounting $\varnothing$ 47.5mm heating circuits 1 L 415mm W 36mm H 43mm number of thermostat sleeves 1 thermostat sleeves $\varnothing$ 6mm length thermostat sleeves 267mm thermostat sleeve clinging tube $\varnothing$ 9mm hole distance 62mm hole $\varnothing$ 8mm connection M4 3 hole flange immersion heater		
<b>For models:</b>	E9P15I, E9P15IA, LXE9P15I, SE9P15I, SE9P15IA		
<b>accessories for</b>	418065		
	<b>Part No.</b>	510408	<b>Ref. No.</b> 35859500
	O-ring EPDM thickness 5.34mm ID $\varnothing$ 47mm Qty 1 pcs		
	<b>Part No.</b>	510562	<b>Ref. No.</b> —
	O-ring silicone thickness 5.34mm ID $\varnothing$ 47mm Qty 1 pcs		

3 hole flange  $\varnothing$ 57.5mm

1

<b>Part No.</b>	417739	<b>Ref. No.</b>	31015900
<b>description</b>	heating element 4000W 230V mounting $\varnothing$ 57.5mm heating circuits 3 L 300mm W 42mm H 44mm number of thermostat sleeves 1 thermostat sleeves $\varnothing$ 7.5mm length thermostat sleeves 230mm tube $\varnothing$ 6.3mm hole $\varnothing$ 8x10mm connection M4 3 hole flange immersion heater		
<b>For models:</b>	CPE40		

with expansion flange 70 x 18mm

1

<b>Part No.</b>	418137	<b>Ref. No.</b>	10622
<b>description</b>	heating element 3000W 230V heating circuits 1 flange 70x18mm L 220mm W 65mm Hmm connection male faston 6.3mm tube $\varnothing$ 8.5mm immersion heater expansion flange connection length 34mm		

1

<b>Part No.</b>	418138	<b>Ref. No.</b>	10620
<b>description</b>	heating element 6000W 230V heating circuits 1 flange 70x18mm L 445mm W 68mm connection male faston 6.3mm tube $\varnothing$ 8.5mm immersion heater expansion flange connection length 34mm		

2"

1

<b>Part No.</b>	416073	<b>Ref. No.</b>	31320200
<b>description</b>	heating element 6000W 220V heating circuits 3 L 315mm W 43mm H 39mm tube $\varnothing$ 8.5mm thermostat sleeves $\varnothing$ 5mm length thermostat sleeves 280mm number of thermostat sleeves 1 thermostat sleeve eccentric, clinging connection M4 immersion heater flange with thread 2"		
<b>For models:</b>	E7PI		
<b>accessories for</b>	416073		
	<b>Part No.</b>	510407	<b>Ref. No.</b> —
	flat gasket fibre ED $\varnothing$ 78mm ID $\varnothing$ 60mm thickness 2mm for heating element for thread 2" Qty 1 pcs		

heating elements for convection

1



<b>Part No.</b>	418129	<b>Ref. No.</b>	10638
<b>description</b>	heating element 16000W 230V heating circuits 3 ID $\varnothing$ 337mm ED $\varnothing$ 358mm L 450mm H 100mm L1 84mm W1 108mm H1 15mm H2 85mm flange length 142mm flange width 25mm hole distance 64mm connection M4 tube $\varnothing$ 8.5mm convection heating element hole $\varnothing$ 6mm rectangular flange		







			
1			
<b>Part No.</b>	418127	<b>Ref. No.</b>	10641
<b>description</b>	heating element 16000W 230V heating circuits 3 ID ø 390mm ED ø 410mm L 430mm H 99mm L1 15mm W1 100mm H1 15mm H2 84mm flange length 142mm flange width 25mm hole distance 63mm connection M4 tube ø 8.5mm convection heating element hole ø 6mm rectangular flange		

			
1			
<b>Part No.</b>	418133	<b>Ref. No.</b>	23019200
<b>description</b>	heating element 2000W 220V heating circuits 1 ID ø 187mm ED ø 200mm L 215mm H 25mm L1 15mm W1 60mm H1 5mm H2 20mm flange length 100mm flange width 22mm hole distance 86mm connection male faston 6.3mm connection length 37mm tube ø 6.5mm convection heating element hole ø 5mm rectangular flange		
<b>For models:</b>	LAU-10, WAV-E1-2, WAV-E2-3		

			
1			
<b>Part No.</b>	416040	<b>Ref. No.</b>	22015500
<b>description</b>	heating element 2500W 230V heating circuits 1 ID ø 185mm ED ø 198mm L 212mm H 30mm L1 17mm W1 32mm H1 6mm H2 24mm flange length 70mm flange width 22mm hole distance 56mm connection male faston 6.3mm connection length 33mm tube ø 6.5mm dry heating element hole ø 5mm rectangular flange		
<b>For models:</b>	E4F+FCD8, E4F+FCDQ8, E7P4+FE1, E7P4-VTR+FE1, E7P6+FE1, E7PQ4+FE1, E7PQ6+FE1, E9P4+FE1, E9P4-VTR+FE1, E9P6+FE1, E9PQ4+FE1, E9PQ6+FE1, G4F+FCD8, G4S+FCGN, G6S+FCGN, G7F4+FE1, G7F4E+FE1, G7F4E+FE1+A4, G7F4E+FG1, G7F4E+FG1+A4, G7F6+FE1, G7F6E+FE1, G7F6E+FE1+A6, G7F6E+FG1, G7F6E+FG1+A6, G9F4+FE1, G9F4E+FE1, G9F4E+FE1+A4, G9F6+FE1, G9F6E+FE1, G9F6E+FE1+A6, G9F8+2FE1		
<b>accessories for</b>	416040		
	<b>Part No.</b>	510368	<b>Ref. No.</b> —
	gasket L 70mm W 23.5mm hole ø 5mm hole distance 56mm FIBER thickness 2mm for heating element		

			
1			
<b>Part No.</b>	420520	<b>Ref. No.</b>	23930000
<b>description</b>	heating element 3000W 440V heating circuits 1 ID ø 180mm ED ø 193mm L 204mm H 25mm L1 2mm W1 60mm H1 15mm H2 34mm flange length 100mm flange width 22mm hole distance 86mm connection F6.3 tube ø 6.5mm		

			
1			
<b>Part No.</b>	418134	<b>Ref. No.</b>	23020500
<b>description</b>	heating element 3300W 240V heating circuits 1 ID ø 185mm ED ø 200mm L 215mm H 30mm W1 60mm H1 5mm H2 25mm flange length 100mm flange width 22mm hole distance 85mm connection male faston 6.3mm connection length 22mm tube ø 6.5mm convection heating element hole ø 5mm rectangular flange		
<b>For models:</b>	E6P4+FE1, E6P6+FE1, E6PQ2H6+FE1, E6PQ2H6+FE1+T, E6PQ2P9+-FE1, E7P4+FE1, E7P4-VTR+FE1, E7P6+FE1, E7PQ4+FE1, E7PQ4+FE1+T, E7PQ6+FE1, E7PQ6+FE1+T, E9P4+FE1, E9P4P-VTR+FE1, E9P4-VTR+-FE1, E9P6+FE1, E9PQ4+FE1, E9PQ4+FE1+T, E9PQ6+FE1, E9PQ6+-FE1+T, G6F2H6+FE1, G6F2H9+FE1, G6F2P6+FE1, G6F2P9+FE1, G6F3H12+FE1, G6F4+FE1, G6F4+FE1+A4, G6F4PW+FE1, G6F4PW+-FE1+AE, G6F6+FE1, G6F6+FE1+A6, G6F6PW+FE1, G6F6PW+FE1+AE, G7F4+FE1, G7F4E+FE1, G7F4E+FE1+A4, G7F4PW+FE1, G7F4PW+-FE1+AE, G7F6+FE1, G7F6E+FE1, G7F6E+FE1+A6, G7F6PW+FE1, G7F6PW+FE1+AE, G9F4+FE1, G9F4E+FE1, G9F4E+FE1+A4, G9F4PW+FE1, G9F4PW+-FE1+AE, G9F6+FE1, G9F6E+FE1...(Other models you can see in the webshop)		





			
1			
<b>Part No.</b>	418130	<b>Ref. No.</b>	25020800
<b>description</b>	heating element 3900W 230V heating circuits 3 ID ø 175mm ED ø 245mm L 285mm H 32mm L1 60mm W1 62mm H1 10mm H2 26mm flange length 93mm flange width 22mm hole distance 77mm connection male faston 6.3mm connection length 61mm tube ø 6.5mm convection heating element hole ø 5mm rectangular flange		
<b>For models:</b>	MM2-3EA, MM2-3EB, PASTRY-VIP-EMU		



			
1			
<b>Part No.</b>	418131	<b>Ref. No.</b>	23021300
<b>description</b>	heating element 6000W 230V heating circuits 3 ID ø 217mm ED ø 231mm L 271mm H 90mm L1 41mm W1 103mm H1 24mm H2 66mm flange length 140mm flange width 22mm hole distance 63mm tube ø 6.3mm convection heating element hole ø 5mm rectangular flange		
<b>For models:</b>	WAV-E5U		

			
1			
<b>Part No.</b>	418132	<b>Ref. No.</b>	24020800 25021400
<b>description</b>	heating element 7350W 230V heating circuits 3 ID ø 250mm ED ø 265mm L 277mm H 75mm L1 17mm W1 102mm H1 12mm H2 67mm flange length 143mm flange width 25mm hole distance 7mm connection M4 tube ø 6.5mm convection heating element hole ø 63mm rectangular flange		
<b>For models:</b>	FME06M, FME6, FPE5A, FPE5B, FPE5C, FPE5D, FPE6TURBO, MM06EA, MM06EB, WAV-E6T, WAV-E6TURBO		

			
1			
<b>Part No.</b>	418128	<b>Ref. No.</b>	10633
<b>description</b>	heating element 9000W 230V heating circuits 3 ID ø 500mm ED ø 515mm L 535mm H 95mm L1 13mm W1 105mm H1 15mm H2 80mm flange length 142mm flange width 25mm hole distance 64mm connection M4 tube ø 8.5mm convection heating element hole ø 6mm rectangular flange		

			
1			
<b>Part No.</b>	418135	<b>Ref. No.</b>	23016600
<b>description</b>	heating element 920W 230V heating circuits 1 ID ø 200mm ED ø 215mm L 255mm H 40mm thread 1/4" connection male faston 6.3mm 2 hole fixing mounting distance 24mm tube ø 8.5mm convection heating element		
<b>For models:</b>	WAV-E12, WAV-E6		
<b>accessories for</b>	418135		
		<b>Part No.</b>	361182
		<b>Ref. No.</b>	—
		nut thread 1/4" H 5mm nickel-plated brass WS 17 Qty 1 pcs	
		<b>Part No.</b>	510417
		<b>Ref. No.</b>	—
		flat gasket fibre ED ø 20mm ID ø 14mm thickness 2mm Qty 1 pcs	
		<b>Part No.</b>	520228
		<b>Ref. No.</b>	—
		tooth lock washer ID ø 15.3mm ED ø 24mm steel Qty 1 pcs for thread M14	
		<b>Part No.</b>	550262
		<b>Ref. No.</b>	—
		flat gasket copper ED ø 20mm ID ø 14mm thickness 2mm	

			
1			
<b>Part No.</b>	418139	<b>Ref. No.</b>	25040600
<b>description</b>	heating element 3500W 240V heating circuits 1 L 620mm W 120mm L1 33mm L2 587mm W2 90mm flange length 70mm flange width 22mm hole distance 56mm connection length 100mm connection M4 tube ø 8.5mm hole ø 6mm W1 30mm rectangular flange convection heating element windings 2		
<b>For models:</b>	FME10, FME10EP, FME10M, FME20, FME20M, FPE12TURBO, MM10EA, MM10EB, WAV-E12T, WAV-E12TURBO, WAV-E20		

radiation heaters

			
1			
<b>Part No.</b>	490152	<b>Ref. No.</b>	31927100
<b>description</b>	radiation heater octagonal 2500W 230V L 250mm W 250mm heating circuits 2 with heating coil energy regulation with temperature signalization connections 3+2 connection type cable AD		
<b>For models:</b>	E6P2M-VTR, E6P4M-VTR, E7P2B-VTR, E7P2M-VTR, E7P4B-VTR, E7P4MVTR, E7P4-VTR+FE, E7P4-VTR+FE1		



## hot plates

## square &amp; rectangular

## with radiused edge

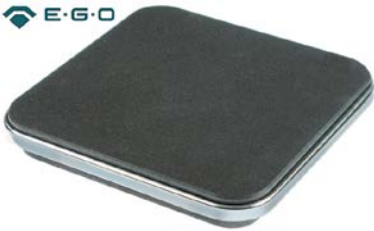

1

<b>Part No.</b>	490066 <sup>1</sup>	<b>Ref. No.</b>	22037400
<b>description</b>	hot plate dimensions 220x220mm 2600W 230V with spill ring connection 4 screw clamps protector yes square		
<b>For models:</b>	E2FQS4, E4F+FCDQ8, E4FDQ8, E6PQ2BH6, E6PQ2BH6+T, E6PQ2H6+FE1, E6PQ2H6+FE1+T, E6PQ2MH6, E6PQ2MH6+T, E7PQ2B, E7PQ2B+T, E7PQ2M, E7PQ2M+T, E7PQ4+FE, E7PQ4+FE+T, E7PQ4+FE1, E7PQ4+FE1+T, E7PQ4+FES, E7PQ4B, E7PQ4B+T, E7PQ4M, E7PQ4M+T, E7PQ6+FE, E7PQ6+FE+T, E7PQ6+FE1, E7PQ6+FE1+T, E7PQ6+FES, E7PQ6B, E7PQ6B+T, E7PQ6M, E7PQ6M+T		

<sup>1</sup>incl. protector

1

<b>Part No.</b>	490071 <sup>1</sup>	<b>Ref. No.</b>	35037400
<b>description</b>	hot plate dimensions 300x300mm 4000W 230V with spill ring connection 4 screw clamps protector yes square		
<b>For models:</b>	E9PQ2M, E9PQ2M+T, E9PQ4+FE, E9PQ4+FE+T, E9PQ4+FE1, E9PQ4+FE1+T, E9PQ4+FES, E9PQ4M, E9PQ4M+T, E9PQ6+FE, E9PQ6+FE+T, E9PQ6+FE1, E9PQ6+FE1+T, E9PQ6+FES, E9PQ6M, E9PQ6M+T		

<sup>1</sup>incl. protector

## round

## with radiused edge

## for domestic and commercial kitchens

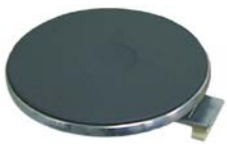

1

<b>Part No.</b>	490020	<b>Ref. No.</b>	22037800
<b>description</b>	hot plate ø 220mm 2600W 230V connection 4 screw clamps with 8mm spill ring		
<b>For models:</b>	E2FS4, E4F+FCD8, E4FD8, E7P2B, E7P2M, E7P4+FE, E7P4+FE1, E7P4+FES, E7P4B, E7P4M, E7P6+FE, E7P6+FE1, E7P6+FES, E7P6B, E7P6M		
<b>accessories for</b>	490020		
	<b>Part No.</b>	550796	<b>Ref. No.</b>
	fixing plate for hot plate ø220mm		



1

<b>Part No.</b>	490062	<b>Ref. No.</b>	35037800
<b>description</b>	hot plate ø 300mm 3500W 220V connection 4 screw clamps with 8mm spill ring		
<b>For models:</b>	E9P2M, E9P4+FE, E9P4+FE1, E9P4+FES, E9P4M, E9P6+FE, E9P6+FE1, E9P6+FES, E9P6M		

## energy regulators

## EGO

## 1-circuit



1

<b>Part No.</b>	380015	<b>Ref. No.</b>	24114800 27114900 27115100
<b>description</b>	energy regulator 230V 13A single-circuit turn direction right shaft ø 6x4.6mm shaft L 23mm mounting thread M4 power release 6-100% no. 50.57021.010		
<b>For models:</b>	E6BM3B, E6BM3M, E6BM6B, E6BM6M, E6PL60B, E6PL60M, E9BM4M, E9BM8M, E9P2MP-VTR, E9P4MP-VTR, E9P4P-VTR+FE, E9P4P-VTR+FE1, E9PL40M, E9PL80M, EGRM4, EGRS4, FME06M, FME10M, FME20M, FMG10M, FMG20M, FMG6, FMG6M, FPE12TURBO, FPE6TURBO, FPG12, FPG5A, FPG5B, FPG6, LXE9P2P-VTR, LXE9P4P-VTR, PLE40BE, PLE40ME, PLE80BE, PLE80ME, SA-E48, SA-E60, SA-E60-E, SA-E68, SA-E68M, SA-E68M-E, SE9BM4M, SE9BM8M, SE9P2MP-VTR, SE9P4MP-VTR, SE9P4P-VTR+FE, SE9PL40M, SE9PL80M, WAV-E12, WAV-E12T...(Other models you can see in the webshop)		

## thermostats

## control and safety thermostats

## EGO

## control thermostats

## 55.10/19\_ series



1

<b>Part No.</b>	375647	<b>Ref. No.</b>	25070800
<b>description</b>	thermostat t.max. 110°C temperature range 31-110°C 1-pole 1NO 16A probe ø 6mm probe L 133mm capillary pipe 870mm capillary pipe isolatedmm gland nut shaft ø 6x4.6mm shaft L 23mm shaft position upper rotation 318°		
<b>For models:</b>	MM2-3EB		



<b>Part No.</b>	375341	<b>Ref. No.</b>	31290000
<b>description</b>	thermostat t.max. 150°C temperature range 60-150°C 1-pole 1N0 16A probe ø 3mm probe L 219mm capillary pipe 900mm capillary pipe isolated 900mm gland nut shaft ø 6x4.6mm shaft L 23mm shaft position upper rotation 270°		
<b>For models:</b>	G7PI		

<b>Part No.</b>	375363	<b>Ref. No.</b>	35301000
<b>description</b>	thermostat t.max. 161°C temperature range 73-161°C 1-pole 1N0 16A probe ø 3mm probe L 144mm capillary pipe 1600mm capillary pipe isolated 1600mm gland nut shaft ø 6x4.6mm shaft L 23mm shaft position upper rotation 270°		
<b>For models:</b>	E9P10I, E9P10IA, E9P15I, E9P15IA, LXE9P15I, SE9P10I, SE9P10IA, SE9P15I, SE9P15IA		

<b>Part No.</b>	375063	<b>Ref. No.</b>	22056700 22064932
<b>description</b>	thermostat t.max. 170°C temperature range 70-170°C 1-pole 1N0 16A probe ø 11mm probe L 28mm capillary pipe 900mm capillary pipe isolated 900mm gland nut shaft L 23mm shaft position upper rotation 270° screw-in probe probe thread M14x1		
<b>accessories for</b>	375063		
	<b>Part No.</b>	510417	<b>Ref. No.</b> —
	flat gasket fibre ED ø 20mm ID ø 14mm thickness 2mm Qty 1 pcs		
	<b>Part No.</b>	510420	<b>Ref. No.</b> —
	gasket copper ED ø 19.9mm ID ø 14.3mm thickness 2mm Qty 1 pcs		
	<b>Part No.</b>	521133	<b>Ref. No.</b> —
	nut thread M14x1.5 H 6mm WS 19 zinc-coated steel Qty 1 pcs		

<b>Part No.</b>	375856	<b>Ref. No.</b>	32065700
<b>description</b>	thermostat t.max. 187°C temperature range 101-187°C 1-pole 1N0 16A probe ø 6mm probe L 130mm capillary pipe 900mm capillary pipe isolated 700mm gland nut M10x1 shaft ø 6x4.6mm shaft L 23mm shaft position upper rotation 270°		
<b>For models:</b>	GL18+18MI, GL18MI		

<b>Part No.</b>	376096	<b>Ref. No.</b>	32065800
<b>description</b>	thermostat t.max. 192°C temperature range 101-192°C 1-pole 1N0 probe ø 6mm probe L 133mm capillary pipe 1770mm capillary pipe isolated 1450mm gland nut M10x1 shaft ø 6x4.6mm shaft L 25mm rotation 270°		

<b>Part No.</b>	390068	<b>Ref. No.</b>	23063300 23900600
<b>description</b>	thermostat t.max. 269°C temperature range 55-269°C 1-pole 1C0 16A probe ø 3.1mm probe L 219mm capillary pipe 1280mm capillary pipe isolated 1270mm gland nut shaft ø 6x4.6mm shaft L 23mm shaft position upper rotation 318°		
<b>For models:</b>	FC100EM, FC100GM, FC200EB, FC200GB, FC60EM, FC60GM, FME06M, FME10M, FME20M, FMG10M, FMG20M, FMG6, FMG6M, FPE12TURBO, FPE6TURBO, FPG12, FPG6, MM06EB, MM06GB, MM10EB, MM10GB, MM2-3EB, PASTRY-EM, PASTRY-VIP-EMU, WAV1-GAS, WAV2-1K-GAS, WAV3-GAS, WAV-E12, WAV-E12T, WAV-E12TURBO, WAV-E20, WAV-E5U, WAV-E6, WAV-E6T, WAV-E6TURBO, WAV-G12, WAV-G20, WAV-G5U, WAV-G6		



E·G·O



<b>Part No.</b>	375216	<b>Ref. No.</b>	22061900
<b>description</b>	thermostat t.max. 280°C temperature range 50-280°C 1-pole 1NO 16A probe $\varnothing$ 3mm probe L 228mm capillary pipe 1300mm capillary pipe isolated 1150mm gland nut shaft L 23mm shaft position upper rotation 318°		
<b>For models:</b>	E4F+FCD8, E4F+FCDQ8, G4F+FCD8		

E·G·O



<b>Part No.</b>	375327	<b>Ref. No.</b>	23063600
<b>description</b>	thermostat t.max. 297°C temperature range 58-297°C 1-pole 1NO 16A probe $\varnothing$ 3.03mm probe L 219mm capillary pipe 870mm capillary pipe isolatedmm gland nut shaft L 23mm shaft position upper rotation 270°		
<b>For models:</b>	E7P4-VTR+FE1, E9BR8, E9BR8-I, E9P4+FE1, E9P4P-VTR+FE1, E9P6+-FE1, G4S+FCGN, G6F3H12+FE1, G6F4PW+FE1, G6F4PW+FE1+AE, G6F6PW+FE1, G6F6PW+FE1+AE, G6S+FCGN, G7F4PW+FE1, G7F-4PW+FE1+AE, G7F6PW+FE1, G7F6PW+FE1+AE, G9F4PW+FE1, G9F-4PW+FE1+AE, G9F6PW+FE1, G9F6PW+FE1+AE, G9F8+2FE1, SE9BR8, SE9BR8-I, SNACK-E, WAV-1, WAV1-2, WAV1-GAS, WAV2-3, WAV2-GAS, WAV3-GAS, WAV-E1-2, WAV-E2-3		

E·G·O



<b>Part No.</b>	375002	<b>Ref. No.</b>	22063600 22063623
<b>description</b>	thermostat t.max. 320°C temperature range 55-320°C 1-pole 1NO 16A probe $\varnothing$ 3.1mm probe L 226mm capillary pipe 870mm capillary pipe isolated 850mm gland nut shaft L 23mm shaft position upper rotation 270°		

55.13\_ series

E·G·O



<b>Part No.</b>	375401	<b>Ref. No.</b>	33065600
<b>description</b>	thermostat t.max. 185°C temperature range 97-185°C 1-pole 1NO 16A probe $\varnothing$ 6mm probe L 87mm capillary pipe 1430mm capillary pipe isolated 1100mm gland nut M9x1 shaft $\varnothing$ 6x4.6mm shaft L 23mm shaft position upper rotation 270°		
<b>For models:</b>	4+4LB-LD, 4LB-LD, 8+8LB-LD, 8LB-LD, ELT10+10B, ELT10B, ELT12+12B, ELT12+12M, ELT12B, ELT12M, ELT4+4B, ELT4B, ELT8+8B, ELT8+8B-E, ELT8B, ELT8B-E		

E·G·O



<b>Part No.</b>	391032	<b>Ref. No.</b>	35301200
<b>description</b>	thermostat t.max. 291°C temperature range 30-291°C 1-pole 1NO 16A probe $\varnothing$ 3mm probe L 160mm capillary pipe 1500mm capillary pipe isolated 770mm gland nut shaft $\varnothing$ 6x4.6mm shaft L 23mm shaft position upper		
<b>For models:</b>	E9BR8-I, LXE9BR8-I, SE9BR8-I		



55.34\_ series



<b>Part No.</b>	375385	<b>Ref. No.</b>	22062900 33066000 33066200
<b>description</b>	thermostat t.max. 180°C temperature range 100-180°C 3-pole 3NO 16A probe ø 6mm probe L 131mm capillary pipe 2000mm capillary pipe isolated 1800mm gland nut shaft ø 6x4.6mm shaft L 23mm shaft position upper rotation 270°		
<b>For models:</b>	E10+10MB6, E10B4, E6F10-3B, E6F10-3BS, E6F10-3M, E6F10-3MS, E6F10-6B, E6F10-6BS, E6F10-6M, E6F10-6MS, E7F10-4B, E7F10-4BS, E7F10-4M, E7F10-4MS, E7F10-8B, E7F10-8BS, E7F10-8M, E7F10-8MS, E7F18-4M, E7F18-4MS, E7F18-8M, E7F18-8MS, E7F30-8B, E7F30-8BP, E7F30-8M, E7F30-8MP, ELT10+10B-E, ELT10B-E, ELT12+12B-E, ELT12+12M, ELT12+12M-E, ELT12B-E, ELT12M, ELT12M-E, ELT15+15B, ELT15+15B-E, ELT15+15M, ELT15+15M-E, ELT15B, ELT15B-E, ELT15M, ELT15M-E, ELT16B, ELT18+18B, ELT18+18BE, ELT18+18B-E, ELT18+18M, ELT18+18M-E, ELT18+18M-E224, ELT18B...(Other models you can see in the webshop)		



<b>Part No.</b>	375097	<b>Ref. No.</b>	22062900
<b>description</b>	thermostat t.max. 195°C temperature range 95-195°C 3-pole 3NO 16A probe ø 6mm probe L 117mm capillary pipe 1780mm capillary pipe isolated 1400mm gland nut M9x1 shaft ø 6x4.6mm shaft L 23mm shaft position upper rotation 270°		



<b>Part No.</b>	375470	<b>Ref. No.</b>	30064900
<b>description</b>	thermostat t.max. 278°C temperature range 71-278°C 3-pole 3NO 16A probe ø 6mm probe L 75mm capillary pipe 1180mm capillary pipe isolated 1100mm gland nut shaft ø 6x4.6mm shaft L 23mm rotation 270° probe material SS		
<b>For models:</b>	E6BR6B, E6BR6M, E6FL3B, E6FL3BP, E6FL3B-P, E6FL3BP-CR, E6FL3BPSX, E6FL3B-SX, E6FL3M, E6FL3MP, E6FL3M-P, E6FL3MP-CR, E6FL3MPSX, E6FL3M-SX, E6FL6B-2, E6FL6B-2-SX, E6FL6BP-2, E6FL6BP-2-CR, E6FL6BP-2-SX, E6FL6M-2, E6FL6M-2-SX, E6FL6MP-2, E6FL6MP-2-CR, E6FL6MP-2-SX, E6FM6B-2, E6FM6BP-2, E6FM6M-2, E6FM6MP-2, E6FR3B, E6FR3BP, E6FR3M, E6FR3MP, E6FR6B-2, E6FR6BP-2, E6FR6M-2, E6FR6MP-2, E6P6+TE, E6PQ2P9+TE, E7BR4B, E7BR4M, E7BR8, E7BR8-I, E7FL4B, E7FL4B-CR, E7FL4BP, E7FL4BP-CR, E7FL4BP-SX, E7FL4B-SX, E7FL4M, E7FL4M-CR...(Other models you can see in the webshop)		



<b>Part No.</b>	375038	<b>Ref. No.</b>	22062600
<b>description</b>	thermostat t.max. 300°C temperature range 50-300°C 3-pole 3NO 16A probe ø 6mm probe L 79mm capillary pipe 1740mm capillary pipe isolated 800mm gland nut shaft ø 6x4.6mm shaft L 23mm shaft position upper rotation 270°		
<b>For models:</b>	E6FL3B, E6FL3B-P, E6FL3BP-SX, E6FL3B-SX, E6FL3M, E6FL3M-P, E6FL3MP-SX, E6FL3M-SX, E6FL6B-2, E6FL6B-2-SX, E6FL6BP-2, E6FL6BP-2-SX, E6FL6M-2, E6FL6M-2-SX, E6FL6MP-2, E6FL6MP-2-SX, E6FM6B-2, E6FM6BP-2, E6FM6M-2, E6FM6MP-2, E6FR3B, E6FR3BP, E6FR3M, E6FR3MP, E6FR6B-2, E6FR6BP-2, E6FR6M-2, E6FR6MP-2, E6PQ2P9+TE, E7BR8, E7FL4B, E7FL4B-CR, E7FL4B-SX, E7FL4M, E7FL4MCR, E7FL4M-SX, E7FL8B-2, E7FL8B-2-CR, E7FL8B-2-SX, E7FL8M-2, E7FL8M-2-CR, E7FL8M-2-SX, E7FM8B-2, E7FM8M-2, E7FR4B, E7FR4M, E7FR8B-2, E7FR8M-2, E7P4+FE, E7P4-VTR+FE...(Other models you can see in the webshop)		
<b>accessories for</b>	375038		
		<b>Part No.</b>	110123
		<b>Ref. No.</b>	—
	knob thermostat t.max. 300°C ø 50mm shaft ø 6x4.6mm shaft flat upper black temperature range 50-300°C rotation 270°		

56.\_ series



<b>Part No.</b>	391034	<b>Ref. No.</b>	35300200 35300800
<b>description</b>	safety thermostat t.max. 182°C temperature range 13-182°C 1-pole 1NC 16A probe ø 4mm probe L 93mm capillary pipe 2445mm capillary pipe isolated 1210mm gland nut shaft ømm shaft Lmm shaft position° probe material SS		
<b>For models:</b>	E9P10I, E9P10IA, E9P15I, E9P15IA, LXE9P15I, SE9P10I, SE9P10IA, SE9P15I, SE9P15IA		



## safety thermostats

55.10/19\_series

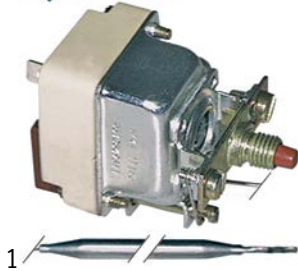

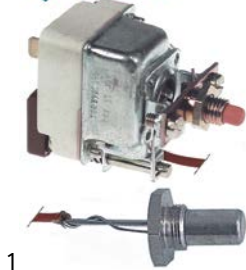

1

<b>Part No.</b>	375250	<b>Ref. No.</b>	25070000
<b>description</b>	safety thermostat capillary pipe 870mm probe ø 6mm 1-pole probe L 129mm 16A capillary pipe isolated gland nut switch-off temp. 130°C probe SS		
<b>For models:</b>	FME10, FME10EP, FME20, FME6, FMG10M, FMG20M, FMG6, FMG6M		
<b>spare parts for</b>	375250		
	<b>Part No.</b>	551083	<b>Ref. No.</b> —
	cap for safety thermostat thread M8x1		



1

<b>Part No.</b>	375282	<b>Ref. No.</b>	22070432
<b>description</b>	safety thermostat switch-off temp. 230°C 1-pole 16A probe ø 11mm probe L 28mm capillary pipe 850mm capillary pipe isolated 830mm gland nut probe screw-in probe probe thread M14x1		
<b>accessories for</b>	375282		
	<b>Part No.</b>	507313	<b>Ref. No.</b> —
	O-ring EPDM thickness 2.62mm ID ø 13.95mm Qty 1 pcs		
	<b>Part No.</b>	510420	<b>Ref. No.</b> —
	gasket copper ED ø 19.9mm ID ø 14.3mm thickness 2mm Qty 1 pcs		
	<b>Part No.</b>	521133	<b>Ref. No.</b> —
	nut thread M14x1.5 H 6mm WS 19 zinc-coated steel Qty 1 pcs		

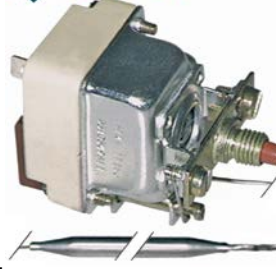

1

<b>Part No.</b>	390062	<b>Ref. No.</b>	22069400 32070200
<b>description</b>	safety thermostat switch-off temp. 235°C 1-pole 0.5A probe ø 6mm probe L 130mm capillary pipe 1800mm capillary pipe isolated 1500mm gland nut M9x1 probe SS		
<b>For models:</b>	6GL18M, 9GL15+15M, 9GL15M, 9GL20+20M, 9GL20M, E10+10MB6, E10B4, GL10+10B, GL10+10M, GL10B, GL10M, GL15+15M, GL15M, GL20+20M, GL20M, GL30B, GL30M, GL8+8B, GL8+8M, GL8B, GL8M		
<b>accessories for</b>	390062		
	<b>Part No.</b>	551083	<b>Ref. No.</b> —
	cap for safety thermostat thread M8x1		



1

<b>Part No.</b>	391031	<b>Ref. No.</b>	32070300
<b>description</b>	safety thermostat switch-off temp. 235°C 1-pole 1C0 16A probe ø 6mm probe L 133mm capillary pipe 870mm shaft ømm probe SS		
<b>For models:</b>	6GL18B, 9GL15+15M, 9GL15M, 9GL20+20M, 9GL20M, GL10+10B, GL10+10M, GL10B, GL10M, GL15+15M, GL15M, GL20+20M, GL20M, GL30B, GL30M, GL7+7M, GL8+8B, GL8+8M, GL8B, GL8M, S9GL20+20M, S9GL20M, S9GL22M		



1

<b>Part No.</b>	375352	<b>Ref. No.</b>	22069400
<b>description</b>	safety thermostat switch-off temp. 245°C 1-pole 1NC 16A probe ø 6mm probe L 130mm capillary pipe 1200mm capillary pipe isolated 1200mm gland nut probe		



55.32\_ series



<b>Part No.</b>	375281	<b>Ref. No.</b>	31290200
<b>description</b>	safety thermostat switch-off temp. 150°C 3-pole 0.5A probe ø 3mm probe L 188mm capillary pipe 1100mm capillary pipe isolated gland nut probe SS		
<b>For models:</b>	E7PI, G7PI		





<b>Part No.</b>	375649	<b>Ref. No.</b>	25070100
<b>description</b>	safety thermostat switch-off temp. 160°C 3-pole 20A probe ø 6mm probe L 87mm capillary pipe 890mm capillary pipe isolated 880mm gland nut probe SS		
<b>For models:</b>	FME06M, FME10M, FME20M, FMG10, FMG10EP, FMG10M, FMG20, FMG6, FMG6EP		



<b>Part No.</b>	375364	<b>Ref. No.</b>	35300000
<b>description</b>	safety thermostat switch-off temp. 190°C 3-pole 20A probe ø 4mm probe L 120mm capillary pipe 3000mm capillary pipe isolated 3000mm gland nut probe		
<b>For models:</b>	E9P10I, E9P10IA, E9P15I, E9P15IA, G9P10I, G9P10IA, G9P15I, G9P15IA, LXG9P15I, SE9P10I, SE9P10IA, SE9P15I, SE9P15IA, SG9P10I, SG9P10IA, SG9P15I		



<b>Part No.</b>	375320	<b>Ref. No.</b>	33070800	
<b>description</b>	safety thermostat switch-off temp. 230°C 3-pole 3NC 20A probe ø 6mm probe L 79mm capillary pipe 1700mm capillary pipe isolated 1100mm gland nut probe SS			
<b>For models:</b>	E6F10-3B, E6F10-3BS, E6F10-3M, E6F10-3MS, E6F10-6B, E6F10-6BS, E6F10-6M, E6F10-6MS, E7F10-4B, E7F10-4BS, E7F10-4M, E7F10-4MS, E7F10-8B, E7F10-8BS, E7F10-8M, E7F10-8MS, E7F18-4M, E7F18-4MS, E7F18-8M, E7F18-8MS, E7F30-8B, E7F30-8BP, E7F30-8M, E7F30-8MP, E9F15-4M, E9F15-8M, E9F18-4M, E9F18-8M, ELT10+10B-E, ELT10B-E, ELT12+12B-E, ELT12+12M, ELT12+12M-E, ELT12B-E, ELT12M, ELT12M-E, ELT15+15B, ELT15+15B-E, ELT15+15M, ELT15+15M-E, ELT15B, ELT15B-E, ELT15M, ELT15M-E, ELT16B, ELT18+18B, ELT18+18BE, ELT18+18B-E, ELT18+18M, ELT18+18M-E... (Other models you can see in the webshop)			
<b>accessories for</b>	375320			
	<b>Part No.</b>	100779	<b>Ref. No.</b>	—
	nut thread M10x0.75 H 3mm WS 14 SS Qty 2 pcs			
	<b>Part No.</b>	551272	<b>Ref. No.</b>	—
	cap for safety thermostat thread M10x0.75			



<b>Part No.</b>	391033	<b>Ref. No.</b>	32070800
<b>description</b>	safety thermostat switch-off temp. 240°C temperature range 19-240°C 3-pole 3NC 16A probe ø 6mm probe L 80mm capillary pipe 1680mm capillary pipe isolated 660mm gland nut M10x1 shaft ømm probe SS		





1

<b>Part No.</b>	375469	<b>Ref. No.</b>	22069700
<b>description</b>	safety thermostat switch-off temp. 358°C 3-pole probe $\varnothing$ 6mm probe L 85mm capillary pipe 3000mm capillary pipe isolated 2980mm SS		
<b>For models:</b>	E6BR6B, E6BR6M, E6FL3B, E6FL3BP, E6FL3B-P, E6FL3BP-CR, E6FL3BPSX, E6FL3B-SX, E6FL3M, E6FL3MP, E6FL3M-P, E6FL3MP-CR, E6FL3MPSX, E6FL3M-SX, E6FL6B-2, E6FL6B-2-SX, E6FL6BP-2, E6FL6BP-2-CR, E6FL6BP-2-SX, E6FL6M-2, E6FL6M-2-SX, E6FL6MP-2, E6FL6MP-2-CR, E6FL6MP-2-SX, E6FM6B-2, E6FM6BP-2, E6FM6M-2, E6FM6MP-2, E6FR3B, E6FR3BP, E6FR3M, E6FR3MP, E6FR6B-2, E6FR6BP-2, E6FR6M-2, E6FR6MP-2, E6P6+TE, E7BR4B, E7BR4M, E7BR8, E7BR8-I, E7FL4B, E7FL4B-CR, E7FL4BP, E7FL4BP-CR, E7FL4BP-SX, E7FL4B-SX, E7FL4M, E7FL4M-CR, E7FL4MP...(Other models you can see in the webshop)		

## IMIT / TEMPOMATIC / ARATHERMO

## control thermostats



1

<b>Part No.</b>	375404	<b>Ref. No.</b>	22062400 24064000
<b>description</b>	thermostat t.max. 110°C temperature range 0-90°C 1-pole 1CO 15A probe $\varnothing$ 6mm probe L 104mm capillary pipe 1400mm capillary pipe isolated 1350mm gland nut shaft $\varnothing$ 6x4.6mm shaft L 18mm shaft position upper rotation 270° probe material copper 400V		
<b>For models:</b>	EBMD8, EBMM6, EBMS4		

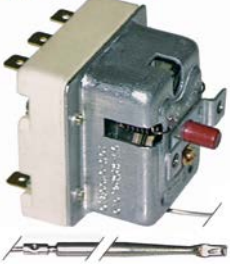

2

<b>Part No.</b>	375350	<b>Ref. No.</b>	35301400
<b>description</b>	safety thermostat switch-off temp. 360°C 3-pole 20A probe $\varnothing$ 4mm probe L 120mm capillary pipe 1800mm capillary pipe isolated 1800mm gland nut probe SS		
<b>For models:</b>	E9BR8-I, LXE9BR8-I, SE9BR8-I		



1

<b>Part No.</b>	390007	<b>Ref. No.</b>	24064000
<b>description</b>	thermostat t.max. 120°C temperature range 0-120°C 1-pole 1CO 16A probe $\varnothing$ 6.5mm probe L 95mm capillary pipe 1000mm capillary pipe isolatedmm gland nut shaft L 19mm shaft position +135° rotation 270°		
<b>For models:</b>	E6PL60B, E6PL60M, E7BM4B, E7BM4M, E7BM8B, E7BM8M, E9BM4M, E9BM8M, E9PL40M, E9PL80M, LAU-10, PLE40ME, PLE80ME, SE-9PL40M, SE9PL80M		

## 56.\_ series



1

<b>Part No.</b>	376095	<b>Ref. No.</b>	32070600 32070700
<b>description</b>	thermostat switch-off temp. 240°C 1-pole 1NC probe $\varnothing$ 6mm probe L 80mm capillary pipe 850mm capillary pipe isolated 450mm gland nut M10x1		
<b>For models:</b>	GL18+18MI, GL18+18MI-E, GL18MI, GL18MI-E		



1

<b>Part No.</b>	375280	<b>Ref. No.</b>	34068300
<b>description</b>	thermostat t.max. 86°C temperature range 0-86°C 1-pole 1CO 16A probe $\varnothing$ 6.5mm probe L 98mm capillary pipe 920mm capillary pipe isolatedmm gland nut shaft $\varnothing$ 6x4.6mm shaft L 20mm shaft position +135° rotation 270° probe material copper		
<b>For models:</b>	SPT120, SPT30, SPT60		



control thermostats with operation switch



<b>Part No.</b>	390139	<b>Ref. No.</b>	30064600
<b>description</b>	thermostat t.max. 270°C temperature range 63-270°C 1-pole 1C0 15A probe ø 3.5mm probe L 195mm capillary pipe 1000mm capillary pipe isolatedmm gland nut shaft ø 6x4.6mm shaft L 17mm shaft position upper rotation 270°		
<b>For models:</b>	E6P4+FE1, E6P6+FE1, E6PQ2H6+FE1, E6PQ2H6+FE1+T, E6PQ2P9+FE1, E7P4+FE1, E7P4+FES, E7P4-VTR+FE1, E7P6+FE1, E7P6+FES, E7PQ4+FE1, E7PQ4+FE1+T, E7PQ4+FES, E7PQ6+FE1, E7PQ6+FE1+T, E7PQ6+FES, E9P4+FE1, E9P4+FES, E9P4P-VTR+FE1, E9P4-VTR+FE1, E9P4-VTR+FES, E9P6+FE1, E9P6+FES, E9PQ4+FE1, E9PQ4+FE1+T, E9PQ4+FES, E9PQ6+FE1, E9PQ6+FE1+T, E9PQ6+FES, G6F2H6+FE1, G6F2H9+FE1, G6F2P6+FE1, G6F2P9+FE1, G6F4+FE1, G6F4+FE1+A4, G6F6+FE1, G6F6+FE1+A6, G7F4+FE1, G7F4+FES, G7F4E+FE1, G7F4E+FE1+A4, G7F4E+FG1, G7F4E+FG1+A4, G7F6+FE1, G7F6+FES, G7F6E+FE1, G7F6E+FE1+A6, G7F6E+FG1, G7F6E+FG1+A6, G9F4E+FE1...(Other models you can see in the webshop)		

CAEM

control thermostats

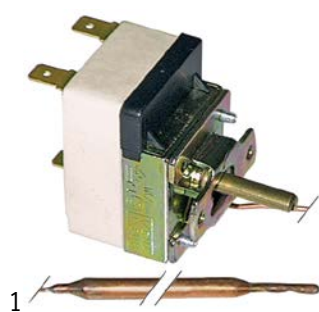

<b>Part No.</b>	375094	<b>Ref. No.</b>	31290500
<b>description</b>	thermostat t.max. 110°C temperature range 30-110°C 1-pole 1C0 16A probe ø 6mm probe L 75mm capillary pipe 1600mm capillary pipe isolatedmm gland nut shaft ø 6x4.6mm shaft L 22mm shaft position upper rotation 270° probe material copper		
<b>For models:</b>	E7PI		

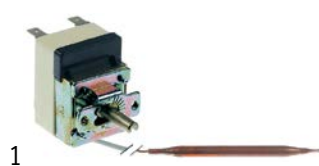

<b>Part No.</b>	375645	<b>Ref. No.</b>	25064500
<b>description</b>	thermostat t.max. 120°C temperature range 30-120°C 1-pole 1C0 16A probe ø 6mm probe L 110mm capillary pipe 1600mm capillary pipe isolated 1550mm gland nut shaft ø 6x4.6mm shaft L 22mm shaft position upper rotation 270° probe material copper 250V		
<b>For models:</b>	FC200EA, FC200EB, FC200GA, FC200GB, MM06EA, MM06EB, MM-06GA, MM06GB, MM10EA, MM10EB, MM10GB, MM2-3EB		

TECASA

safety thermostats



<b>Part No.</b>	390028	<b>Ref. No.</b>	33070300
<b>description</b>	safety thermostat switch-off temp. 230°C 1-pole 16A probe ø 3mm probe L 155mm capillary pipe 890mm capillary pipe isolated 600mm gland nut probe SS		
<b>For models:</b>	10+10LB-LD, 10LB-LD, 12+12LB-LD, 12+12LM-LD, 12LB-LD, 12LM-LD, 4+4LB-LD, 4LB-LD, 8+8LB-LD, 8LB-LD, ELT10+10B, ELT10B, ELT12+12B, ELT12+12M, ELT12B, ELT12M, ELT4+4B, ELT4B, ELT8+8B, ELT8+8B-E, ELT8B, ELT8B-E		

accessories

probe clips

spring clips

for thermostat



<b>Part No.</b>	550390	<b>Ref. No.</b>	33612900
<b>description</b>	probe clip for pipe ø 8mm for probe ø 4mm		
<b>For models:</b>	E6F10-3B, E6F10-3BS, E6F10-3M, E6F10-3MS, E6F10-6B, E6F10-6BS, E6F10-6M, E6F10-6MS, E6F8-3B, E6F8-3M, E6F8-6B, E6F8-6M, E7F10-4B, E7F10-4BS, E7F10-4M, E7F10-4MS, E7F10-8B, E7F10-8BS, E7F10-8M, E7F10-8MS, E7F18-4M, E7F18-4MS, E7F18-8M, E7F18-8MS, E7F30-8B, E7F30-8BP, E7F30-8M, E7F30-8MP, ELT10+10B, ELT10+10B-E, ELT10B, ELT10B-E, ELT12+12B, ELT12+12B-E, ELT12+12M, ELT12+12M-E, ELT12B, ELT12B-E, ELT12M, ELT12M-E, ELT15+15B, ELT15+15B-E, ELT15+15M, ELT15+15M-E, ELT15B, ELT15B-E, ELT15M, ELT15M-E, ELT16B, ELT18+18B...(Other models you can see in the webshop)		



<b>Part No.</b>	550258	<b>Ref. No.</b>	22884200
<b>description</b>	probe clip for pipe ø 8mm for probe ø 6mm		
<b>For models:</b>	E10+10MB6, E10B4		

connecting bows



<b>Part No.</b>	550060	<b>Ref. No.</b>	22699200
<b>description</b>	connecting bow long for thermostat Qty 1 pcs		
<b>For models:</b>	E10+10MB6, E10B4, E4F+FCD8, E4F+FCDQ8, E7BR8, E7BR8-I, EBRS4, EFLD8, EFLD8-CR, EFLM6, EFLM6-2, EFLM6-2-CR, EFLM6-CR, EFLS4, EFLS4-CR, EFM6-2, EFM8, EFRM6, EFRS4, G4F+FCD8		



## switches and momentary switches

## rocker/momentary rocker switches

30x22mm

labelled



1

<b>Part No.</b>	300125	<b>Ref. No.</b>	22056600
<b>description</b>	rocker switch mounting measurements 30x22mm green 2NO 230V 16A 0-I connection male faston 6.3mm ambient temperature max. 125/55°C protection IP65 with cover cap		
<b>For models:</b>	E6SP6B, E6SP6M, E7BM4B, E7BM4M, E7BM8B, E7BM8M, E7SP-4B, E7SP-4M, E9BM4M, E9BM8M, EBMD8, EBMM6, EBMS4, ESPS4, G4F+FSDB		
<b>accessories for</b>	300125		
	<b>Part No.</b>	301036	<b>Ref. No.</b> —
	protective cover internal size 30x22mm for rocker switch mounting measurementsmm		

## push/momentary push switches

28.5x77.5mm



1

<b>Part No.</b>	346365	<b>Ref. No.</b>	25057800
<b>description</b>	switch combination momentary/latching mounting measurements 28.5x77.5mm black 2CO/2CO 250V 16A with indicator connection male faston 6.3mm ambient temperature max. 85°C protection IP40		
<b>For models:</b>	MM06EB, MM06GB, MM10EB, MM10GB		



1

<b>Part No.</b>	346363	<b>Ref. No.</b>	10043
<b>description</b>	switch combination with indicator mounting measurements 28.5x77.5mm black 2CO/2CO 250V 16A connection male faston 6.3mm ambient temperature max. 85°C protection IP40		

ø11mm



1

<b>Part No.</b>	300126	<b>Ref. No.</b>	33059200
<b>description</b>	push button mounting ø M11x1mm black 2NO 250V 16A connection male faston 6.3mm ambient temperature max. 150°C with plunger actuating force: 500g type CM thread L 14mm		
<b>For models:</b>	E7F10-4B, E7F10-4BS, E7F10-4M, E7F10-4MS, E7F10-8B, E7F10-8BS, E7F10-8M, E7F10-8MS, E7F18-4M, E7F18-8M, E9F15-4M, E9F15-8M, E9F18-4M, E9F18-8M, ELT10+10B, ELT10+10B-E, ELT10B, ELT10B-E, ELT12+12B, ELT12+12B-E, ELT12+12M, ELT12+12M-E, ELT12B, ELT12B-E, ELT12M, ELT12M-E, ELT15+15B, ELT15+15B-E, ELT15+15M, ELT15+15M-E, ELT15B, ELT15B-E, ELT15M, ELT15M-E, ELT16B, ELT18+18B, ELT18+18BE, ELT18+18B-E, ELT18+18M, ELT18+18M-E, ELT18+18M-E224, ELT18B, ELT18BE, ELT18B-E, ELT18M, ELT18M-E, ELT30B, ELT30M, ELT4+4B, ELT4B...(Other models you can see in the webshop)		

ø22mm



1

<b>Part No.</b>	348235	<b>Ref. No.</b>	35080000
<b>description</b>	momentary push switch mounting ø 22mm silver 1NC/1NO 250V 5A SS connection soldering connection ambient temperature max. 85°C protection IP40		

## microswitches

## pin-plunger actuated



M10





1

<b>Part No.</b>	347216	<b>Ref. No.</b>	23060600
<b>description</b>	microswitch with plunger thread M10x0.75 thread L 14mm 250V 10A 1CO connection male faston 6.3mm stroke 7.5mm mounting distance 22mm L 28mm ambient temperature max. 125°C type NR6K5 actuating force: 260g		
<b>For models:</b>	FC100EM, FC100EP, FC100GEP, FC100GM, FC200EA, FC200EB, FC200GA, FC200GB, FC60EM, FC60EP, FC60GEP, FC60GM, FME06M, FME10, FME10EP, FME10M, FME20, FME20M, FME6, FMG10, FMG10EP, FMG10M, FMG20, FMG20M, FMG6, FMG6EP, FMG6M, FPE12TURBO, FPE6TURBO, FPG12, FPG6, G7F4P+FG+AF2, G7F6P+FG+AF2, G7F6P+T+AF2, G9BR8-I, G9F4P+FG+AF2, G9F6P+T+AF2, LXG9BR8-I, MM06EA, MM06EB, MM06GA, MM06GB, MM10EA, MM10EB, MM-10GA, MM10GB, MM2-3EA, MM2-3EB, SG9BR8-I, SG9P10I...(Other models you can see in the webshop)		



			
1			
<b>Part No.</b>	347762	<b>Ref. No.</b>	33059400
<b>description</b>	microswitch with plunger thread M10x0.75 thread L 14mm 250V 16A 2NO connection male faston 6.3mm stroke 4mm mounting distance 22mm ambient temperature max. 85°C actuating force: 650g		
<b>For models:</b>	E6F10-3B, E6F10-3BS, E6F10-3M, E6F10-3MS, E6F10-6B, E6F10-6BS, E6F10-6M, E6F10-6MS, E6F8-3B, E6F8-3M, E6F8-6B, E6F8-6M, E6PL60B, E6PL60M, E7F10-4B, E7F10-4BS, E7F10-4M, E7F10-4MS, E7F18-8B, E7F18-8BS, E7F18-8M, E7F18-8MS, E7F18-4M, E7F18-4MS, E7F18-8M, E7F18-8MS, E7F30-8B, E7F30-8BP, E7F30-8M, E7F30-8MP, E9F15-4M, E9F15-8M, E9F18-4M, E9F18-8M, E9PL40M, E9PL80M, ELT10+10B, ELT10+10B-E, ELT10B, ELT10B-E, ELT12+12B, ELT12+12B-E, ELT12+12M, ELT12+12M-E, ELT12B, ELT12B-E, ELT12M, ELT12M-E, ELT15+15B, ELT15+15B-E...(Other models you can see in the webshop)		
<b>accessories for</b>	347762		
	<b>Part No.</b>	100779	<b>Ref. No.</b> —
	nut thread M10x0.75 H 3mm WS 14 SS Qty 2 pcs		

<b>M12</b>			
			
1			
<b>Part No.</b>	345350	<b>Ref. No.</b>	22060200 22060300
<b>description</b>	microswitch with plunger mounting distance 22mm thread M12x0.75 thread L 16mm 250V 16A 1CO connection male faston 6.3mm stroke 4mm ambient temperature max. 125°C type EF83161.3 actuating force: 66g		
<b>For models:</b>	E10+10MB6, E10B4, EGRM4, EGRS4		
<b>accessories for</b>	345350		
	<b>Part No.</b>	345351	<b>Ref. No.</b> —
	nut thread M12x0.75 H 1.6mm WS 14 chrome-plated brass Qty 1 pcs		

## position switches

<b>PIZZATO</b>			
<b>FB series</b>			
			
1			
<b>Part No.</b>	346175	<b>Ref. No.</b>	35837000
<b>description</b>	position switch cast aluminum 1NO/1NC 400V 3A L 52mm W 39mm H 16mm protection IP67 actuating force: 1000g screw connection mounting distance 25mm cable length 1800mm		
<b>For models:</b>	E9BR8		

## system switches (ROLD)

			
1			
<b>Part No.</b>	345537	<b>Ref. No.</b>	10313
<b>description</b>	element holder mounting measurements 20.6x16.4mm grey arched for push buttons 13x17mm		
<b>For models:</b>	FC200GB, WAV-G5U		

			
1			
<b>Part No.</b>	345606	<b>Ref. No.</b>	25061800 3474
<b>description</b>	momentary switch unit 2CO 250V 16A connection male faston 6.3mm		
<b>For models:</b>	FC100EM, FC100GM, FC200EB, FC200GB, FC60EM, FC60GM, PASTRY-EM, PASTRY-VIP-EMU, WAV-G5U		

			
1			
<b>Part No.</b>	345539	<b>Ref. No.</b>	10312
<b>description</b>	push button size 17x13mm grey		
<b>For models:</b>	FC200GB, WAV-G5U		

			
1			
<b>Part No.</b>	345605	<b>Ref. No.</b>	25058400
<b>description</b>	switch 2CO 250V 16A connection male faston 6.3mm		
<b>For models:</b>	FME06M, FME10M, FME20M, FMG10M, FMG20M, FMG6, FMG6M, MM06EB, MM06GB, MM10EB, MM10GB, MM2-3EB		

## cam switches

<b>on/off</b>			
			
1			
<b>Part No.</b>	345665	<b>Ref. No.</b>	22051600
<b>description</b>	cam switch 2 operating positions 4NO sequence 0-1 16A shaft ø 6x4.6mm shaft L 23mm connection screw		

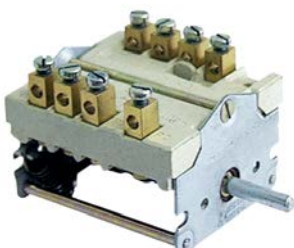

			
1			
<b>Part No.</b>	300095	<b>Ref. No.</b>	22050800
<b>description</b>	cam switch ON-OFF connection screw clamp		
<b>For models:</b>	EGRM4		

## 4-position

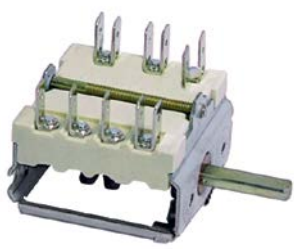
			
1			
<b>Part No.</b>	300007	<b>Ref. No.</b>	22050100
<b>description</b>	cam switch 4 operating positions 1NO/2CO sequence 0-1-2-3 16A shaft $\varnothing$ 6x4.6mm shaft L 23mm connection male faston 6.3mm 4-position ceramic		
<b>For models:</b>	E6CP6B, E6CP6M, E6CPM, ECRM6		

## 7-position

			
1			
<b>Part No.</b>	300004	<b>Ref. No.</b>	22049900
<b>description</b>	cam switch 7 operating positions 1NO/2CO sequence 0-1-2-3-4-5-6 16A shaft $\varnothing$ 6x4.6mm shaft L 23mm connection male faston 6.3mm 7-position ceramic		
<b>For models:</b>	E2FQS4, E2FS4, E4F+FCD8, E4F+FCDQ8, E4FD8, E4FDQ8, E6P2B, E6P2M, E6P4+FE1, E6P4B, E6P4M, E6P6+FE1, E6P6+TE, E6P6B, E6P6M, E6PQ2BH6, E6PQ2BH6+T, E6PQ2H6+FE1, E6PQ2H6+FE1+T, E6PQ2MH6, E6PQ2MH6+T, E7P2B, E7P2M, E7P4+FE, E7P4+FE1, E7P4+FES, E7P4B, E7P4M, E7P6+FE, E7P6+FE1, E7P6+FES, E7P6B, E7P6M, E7PQ2B, E7PQ2B+T, E7PQ2M, E7PQ2M+T, E7PQ4+FE, E7PQ4+FE+T, E7PQ4+FE1, E7PQ4+FE1+T, E7PQ4+FES, E7PQ4B, E7PQ4B+T, E7PQ4M, E7PQ4M+T, E7PQ6+FE, E7PQ6+FE+T, E7PQ6+FE1, E7PQ6+FE1+T...(Other models you can see in the webshop)		

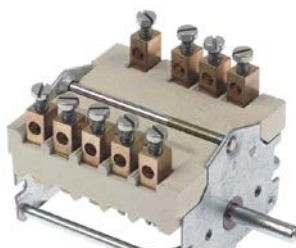
			
1			
<b>Part No.</b>	300264	<b>Ref. No.</b>	35049900
<b>description</b>	cam switch 7 operating positions 1NO/2CO sequence 0-1-2-3-4-5-6 32A shaft $\varnothing$ 6x4.6mm shaft L 23mm connection screw 7-position shaft flat lower		
<b>For models:</b>	E6PQ2BP9, E6PQ2MP9, E6PQ2P9+FE1, E6PQ2P9+TE, SE9PQ2M, SE9PQ4+FE, SE9PQ4M, SE9PQ6+FE, SE9PQ6M		

## 3 operating positions

			
1			
<b>Part No.</b>	345670	<b>Ref. No.</b>	30051600
<b>description</b>	cam switch 3 operating positions 1CO sequence 1-0-2 16A shaft $\varnothing$ 6x4.6mm shaft L 23mm connection male faston 6.3mm		
<b>For models:</b>	12T, E9P10I, E9P10IA, E9P15I, E9P15IA, LXE9P15I, SE9P10I, SE9P10IA, SE9P15I, SE9P15IA		

			
1			
<b>Part No.</b>	300167	<b>Ref. No.</b>	35050100
<b>description</b>	cam switch 3 operating positions 2NO/1CO sequence 0-1-2 16A shaft $\varnothing$ 6x4.6mm shaft L 23mm connection screw		
<b>For models:</b>	E6PQ2P9+FE1, E9P10I, E9P10IA, E9P15I, E9P15IA, SE9P10I, SE9P10IA, SE9P15I, SE9P15IA		



4 operating positions

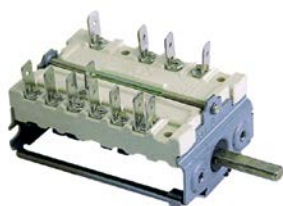

1			
<b>Part No.</b>	300010	<b>Ref. No.</b>	23050900
<b>description</b>	cam switch 4 operating positions 2NO/2CO sequence 0-1-2-3 16A shaft ø 6x4.6mm shaft L 23mm connection male faston 6.3mm ceramic		
<b>For models:</b>	FC100EM, FC100GM, FC200EB, FC200GB, FC60EM, FC60GM, FPE12TURBO, FPE6TURBO, FPG12, FPG6, WAV1-GAS, WAV2-1K-GAS, WAV3-GAS, WAV-E12, WAV-E12T, WAV-E12TURBO, WAV-E20, WAV-E5U, WAV-E6, WAV-E6T, WAV-E6TURBO, WAV-G12, WAV-G20, WAV-G5U, WAV-G6		



1			
<b>Part No.</b>	300081	<b>Ref. No.</b>	22049800
<b>description</b>	cam switch 4 operating positions 3NO/2CO sequence 0-1-2-3 16A shaft ø 6x4.6mm shaft L 23mm connection screw		
<b>For models:</b>	CPE40, E7P4+FE, E7P4-VTR+FE, E7P6+FE, E7PQ4+FE, E7PQ4+FE+T, E7PQ6+FE, E7PQ6+FE+T, E7TP+FE, E9CP40, E9P4+FE, E9P4P-VTR+FE, E9P4-VTR+FE, E9P6+FE, E9PQ4+FE, E9PQ4+FE+T, E9PQ6+FE, E9PQ6+-FE+T, G7F4PW+FE, G7F4PW+FE+AE, G7F6PW+FE, G7F6PW+FE+AE, G9F4+FE, G9F4PW+FE, G9F4PW+FE+AE, G9F6+FE, G9F6PW+FE, G9F6PW+FE+AE, G9F8+2FE, SE9CP40, SE9P4P-VTR+FE, SE9PQ4+FE, SE9PQ6+FE, SG9F4+FE, SG9F6+FE, SG9F8+2FE		

10 operating positions



1			
<b>Part No.</b>	345666	<b>Ref. No.</b>	22049700
<b>description</b>	cam switch 10 operating positions 6NO/1CO sequence 0-1-2-3-4-5-6-7-8-9 8A shaft ø 6x4.6mm shaft L 23mm connection male faston 6.3mm plastic		
<b>For models:</b>	G4S+FCGN, G6S+FCGN		

with potentiometer



1			
<b>Part No.</b>	347599	<b>Ref. No.</b>	38151000 38151200
<b>description</b>	cam switch 2 operating positions 4NO sequence 0-1 16A shaft ø 6x4.6mm shaft L 23mm connection coded plug 0.1-10KOhm 2-pole with potentiometer		
<b>For models:</b>	E9P2M-IND, E9P2M-IND-230V3~, E9P4M-IND, E9P4M-IND-230V3~, E9WOK-IND, LXE9P2-IND, LXE9P2-IND-230V3~, LXE9P4-IND, LXE9P4-IND-230V3~, LXE9WOK-IND, SE9P2M-IND, SE9P2M-IND-230V3~, SE9P4M-IND, SE9P4M-IND-230V3~, SE9WOK-IND		

operation switches



1			
<b>Part No.</b>	300002	<b>Ref. No.</b>	22050300
<b>description</b>	cam switch 2 operating positions 4NO 16A sequence 0-1 shaft ø 6x4.6mm shaft L 23mm connection male faston 6.3mm ceramic		
<b>For models:</b>	E6BR6B, E6BR6M, E6FL3B, E6FL3BP, E6FL3B-P, E6FL3BP-CR, E6FL3BPSX, E6FL3B-SX, E6FL3M, E6FL3MP, E6FL3M-P, E6FL3MP-CR, E6FL3MPSX, E6FL3M-SX, E6FL6B-2, E6FL6B-2-SX, E6FL6BP-2, E6FL6BP-2-CR, E6FL6BP-2-SX, E6FL6M-2, E6FL6M-2-SX, E6FL6MP-2, E6FL6MP-2-CR, E6FL6MP-2-SX, E6FM6B-2, E6FM6BP-2, E6FM6M-2, E6FM6MP-2, E6FR3B, E6FR3BP, E6FR3M, E6FR3MP, E6FR6B-2, E6FR6BP-2, E6FR6M-2, E6FR6MP-2, E6P6+TE, E7BR4B, E7BR4M, E7BR8, E7BR8-I, E7FL4B, E7FL4B-CR, E7FL4BP, E7FL4BP-CR, E7FL4BP-SX, E7FL4B-SX, E7FL4M, E7FL4M-CR, E7FL4MP...(Other models you can see in the webshop)		



1			
<b>Part No.</b>	300153	<b>Ref. No.</b>	23050600
<b>description</b>	cam switch 3 operating positions operation switch 16A sequence 0-1-2 shaft ø 6x4.6mm shaft L 23mm connection male faston 6.3mm plastic ambient temperature max. 240°C		
<b>For models:</b>	WAV1-2, WAV2-3, WAV-E1-2, WAV-E2-3		

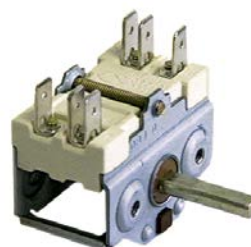

1			
<b>Part No.</b>	300001	<b>Ref. No.</b>	22051000
<b>description</b>	cam switch operation switch 16A sequence 0-1 shaft ø 6x4.6mm connection male faston 6.3mm 2-pole		
<b>For models:</b>	E7F30-8B, E7F30-8BP, E7F30-8M, E7F30-8MP, E9BR8-I, E9P10I, E9P10IA, E9P15I, E9P15IA, E9P4+FE1, E9P6+FE1, G6F3H12+FE1, G6F4PW+FE1, G6F4PW+FE1+AE, G6F6PW+FE1, G6F6PW+FE1+AE, G7F4PW+FE1, G7F4PW+FE1+AE, G7F6PW+FE1, G7F6PW+FE1+AE, G9F4PW+FE1, G9F4PW+FE1+AE, G9F6PW+FE1, G9F6PW+FE1+AE, G9F8+2FE1, GL18+18MI, GL18MI, LXE9BR8-I, LXE9P15I, SE9BR8-I, SE9F18-4M, SE9F18-8M, SE9P10I, SE9P10IA, SE9P15I, SE9P15IA		
<b>accessories for</b>	300001		
		<b>Part No.</b>	551456
		<b>Ref. No.</b>	—
	gasket for switch ED ø 14mm ID ø 2.5mm thickness 3.5mm white		



E-G-O



1

<b>Part No.</b>	300091	<b>Ref. No.</b>	22050400
<b>description</b>	operation switch EGO 2 operating positions 2NO 16A sequence 0-1 shaft ø 6x4.6mm shaft L 23mm connection screw ceramic		
<b>For models:</b>	E10+10MB6, E10B4		

## control equipment

## MOELLER/EATON

## switches (complete)

## rotary switches



1

<b>Part No.</b>	300132	<b>Ref. No.</b>	31205000
<b>description</b>	rotary switch mounting measurements ø22mm green complete		
<b>For models:</b>	E7PI, G7PI		

## push/momentary push switches



1

<b>Part No.</b>	300131	<b>Ref. No.</b>	31923000
<b>description</b>	momentary push switch mounting measurements ø22mm red illuminated, 80-264V 1NO momentary		
<b>For models:</b>	G7PI		

## encoders and potentiometers



1

<b>Part No.</b>	347599	<b>Ref. No.</b>	38151000 38151200
<b>description</b>	cam switch 2 operating positions 4NO sequence 0-1 16A shaft ø 6x4.6mm shaft L 23mm connection coded plug 0.1-10KOhm 2-pole with potentiometer		
<b>For models:</b>	E9P2M-IND, E9P2M-IND-230V3~, E9P4M-IND, E9P4M-IND-230V3~, E9WOK-IND, LXE9P2-IND, LXE9P2-IND-230V3~, LXE9P4-IND, LXE9P4-IND-230V3~, LXE9WOK-IND, SE9P2M-IND, SE9P2M-IND-230V3~, SE9P4M-IND, SE9P4M-IND-230V3~, SE9WOK-IND		

## lamps

## indicator lights

## indicator lights (complete)

ø10mm

with plug-in socket



1

<b>Part No.</b>	359139	<b>Ref. No.</b>	30168800 30866700
<b>description</b>	indicator light ø 10mm green 230V connection male faston 6.3mm Qty 1 pcs		
<b>For models:</b>	E6BR6B, E6BR6M, E6CP3B, E6CP6B, E6CP6M, E6CPM, E6F8-3B, E6F8-3M, E6F8-6B, E6F8-6M, E6FL3B, E6FL3BP, E6FL3B-P, E6FL3BP-CR, E6FL3BP-SX, E6FL3B-SX, E6FL3M, E6FL3MP, E6FL3M-P, E6FL3MP-CR, E6FL3MP-SX, E6FL3M-SX, E6FL6B-2, E6FL6B-2-SX, E6FL6BP-2, E6FL6BP-2-CR, E6FL6BP-2-SX, E6FL6M-2, E6FL6M-2-SX, E6FL6MP-2, E6FL6MP-2-CR, E6FL6MP-2-SX, E6FM6B-2, E6FM6BP-2, E6FM6M-2, E6FM6MP-2, E6FR3B, E6FR3BP, E6FR3M, E6FR3MP, E6FR6B-2, E6FR6BP-2, E6FR6M-2, E6FR6MP-2, E6P2B, E6P2M, E6P4+FE1, E6P4B, E6P4M, E6P6+FE1...(Other models you can see in the webshop)		



1

<b>Part No.</b>	359019	<b>Ref. No.</b>	33171000
<b>description</b>	indicator light ø 10mm green 400V connection male faston 6.3mm Qty 1 pcs		
<b>For models:</b>	CPE40, E6F10-3B, E6F10-3BS, E6F10-3M, E6F10-3MS, E6F10-6B, E6F10-6BS, E6F10-6M, E6F10-6MS, E7F10-4B, E7F10-4BS, E7F10-4M, E7F10-4MS, E7F10-8B, E7F10-8BS, E7F10-8M, E7F10-8MS, E9CP40, ELT10+10B-E, ELT10B-E, ELT12+12B-E, ELT12+12M, ELT12+12M-E, ELT12B-E, ELT12M, ELT12M-E, ELT15+15B, ELT15+15B-E, ELT15+15M, ELT15+15M-E, ELT15B, ELT15B-E, ELT15M, ELT15M-E, ELT16B, ELT18+18B, ELT18+18BE, ELT18+18B-E, ELT18+18M, ELT18+18M-E, ELT18+18M-E224, ELT18B, ELT18BE, ELT18B-E, ELT18M, ELT18M-E, ELT30B, ELT30M, SE9CP40		





1

<b>Part No.</b>	359140	<b>Ref. No.</b>	30168500
<b>description</b>	indicator light ø 10mm yellow 230V connection male faston 6.3mm Qty 1 pcs		
<b>For models:</b>	E6BR6B, E6BR6M, E6F8-3B, E6F8-3M, E6F8-6B, E6F8-6M, E6FL3B, E6FL3BP, E6FL3B-P, E6FL3BP-CR, E6FL3BP-SX, E6FL3B-SX, E6FL3M, E6FL3MP, E6FL3M-P, E6FL3MP-CR, E6FL3MP-SX, E6FL3M-SX, E6FL6B-2, E6FL6B-2-SX, E6FL6BP-2, E6FL6BP-2-CR, E6FL6BP-2-SX, E6FL6M-2, E6FL6M-2-SX, E6FL6MP-2, E6FL6MP-2-CR, E6FL6MP-2-SX, E6FM6B-2, E6FM6BP-2, E6FM6M-2, E6FM6MP-2, E6FR3B, E6FR3BP, E6FR3M, E6FR3MP, E6FR6B-2, E6FR6BP-2, E6FR6M-2, E6FR6MP-2, E6P4+FE1, E6P6+FE1, E6P6+TE, E6PQ2H6+FE1, E6PQ2H6+FE1+T, E6PQ2P9+FE1, E6PQ2P9+TE, E7BM4B, E7BM4M, E7BM8B...(Other models you can see in the webshop)		





			
1			
<b>Part No.</b>	359034	<b>Ref. No.</b>	33171100
<b>description</b>	indicator light ø 10mm yellow 400V connection male faston 6.3mm Qty 1 pcs		
<b>For models:</b>	E6F10-3B, E6F10-3BS, E6F10-3M, E6F10-3MS, E6F10-6B, E6F10-6BS, E6F10-6M, E6F10-6MS, E7F10-4B, E7F10-4BS, E7F10-4M, E7F10-4MS, E7F10-8B, E7F10-8BS, E7F10-8M, E7F10-8MS, ELT10+10B-E, ELT10B-E, ELT12+12B-E, ELT12+12M, ELT12+12M-E, ELT12B-E, ELT12M, ELT12M-E, ELT15+15B, ELT15+15B-E, ELT15+15M, ELT15+15M-E, ELT15B, ELT15B-E, ELT15M, ELT15M-E, ELT16B, ELT18+18B, ELT18+18BE, ELT18+18B-E, ELT18+18M, ELT18+18M-E, ELT18+18M-E224, ELT18B, ELT18BE, ELT18B-E, ELT18M, ELT18M-E, ELT30B, ELT30M		

<p>ø12mm</p> <p>with screw socket</p>			
			
1			
<b>Part No.</b>	359023	<b>Ref. No.</b>	22170532
<b>description</b>	indicator light ø 12mm 24V green connection male faston 6.3mm		

			
1			
<b>Part No.</b>	359291	<b>Ref. No.</b>	33170700
<b>description</b>	indicator light ø 12mm 400V green connection male faston 6.3mm		
<b>For models:</b>	E7PI, G7PI		

<p>with plug-in socket</p>			
			
1			
<b>Part No.</b>	359041	<b>Ref. No.</b>	22167900
<b>description</b>	indicator light ø 12mm green 230V connection male faston 6.3mm temp.-resist. 120°C Qty 1 pcs		
<b>For models:</b>	E10+10MB6, E10B4, E2FQS4, E2FS4, E4F+FCDB, E4F+FCDQ8, E4FD8, E4FDQ8, EBMD8, EBMM6, EBMS4, EBRS4, ECRM6, EFLD8, EFLD8-CR, EFLM6, EFLM6-2, EFLM6-2-CR, EFLM6-CR, EFLS4, EFLS4-CR, EFM6-2, EFM6-2, EFM6-2, EFRM6, EFRS4, EGRM4, EGRS4, G4F+FCDB, G4S+FCGN, G6S+FCGN		

			
1			
<b>Part No.</b>	359042	<b>Ref. No.</b>	22167800
<b>description</b>	indicator light ø 12mm yellow 230V connection male faston 6.3mm temp.-resist. 120°C Qty 1 pcs		
<b>For models:</b>	E10+10MB6, E10B4, E4F+FCDB, E4F+FCDQ8, EBRS4, EFLD8, EFLD8-CR, EFLM6, EFLM6-2, EFLM6-2-CR, EFLM6-CR, EFLS4, EFLS4-CR, EFM6-2, EFM6-2, EFRM6, EFRS4, EGRM4, EGRS4, G4F+FCDB, G4S+FCGN, G6S+FCGN		

<p>ø13mm</p> <p>with screw socket</p>			
			
1			
<b>Part No.</b>	359049	<b>Ref. No.</b>	33170800
<b>description</b>	indicator light ø 13mm 400V green		
<b>For models:</b>	10+10LB-LD, 10LB-LD, 12+12LB-LD, 12+12LM-LD, 12LB-LD, 12LM-LD, 15+15LB-LD, 15+15LM-LD, 15LB-LD, 15LBZ-LD, 15LM-LD, 15LMZ-LD, 18+18LB-LD, 18+18LM-LD, 18LB-LD, 18LM-LD, 8+8LB-LD, 8LB-LD, E9BR8, E9BR8-I, E9P10I, E9P10IA, E9P15I, E9P15IA, SE9BR8, SE9BR8-I, SE9P10I, SE9P10IA, SE9P15I, SE9P15IA		
<b>accessories for</b>	359049		
	<b>Part No.</b>	510302	<b>Ref. No.</b> —
	O-ring EPDM ID ø 12.42mm thickness 1.78mm Qty 1 pcs		
	<b>Part No.</b>	511505	<b>Ref. No.</b> —
	O-ring EPDM thickness 1.78mm ID ø 12.42mm Qty 10 pcs		

			
1			
<b>Part No.</b>	359050	<b>Ref. No.</b>	33170900
<b>description</b>	indicator light ø 13mm 400V yellow		
<b>For models:</b>	10+10LB-LD, 10LB-LD, 12+12LB-LD, 12+12LM-LD, 12LB-LD, 12LM-LD, 15+15LB-LD, 15+15LM-LD, 15LB-LD, 15LBZ-LD, 15LM-LD, 15LMZ-LD, 18+18LB-LD, 18+18LM-LD, 18LB-LD, 18LM-LD, 8+8LB-LD, 8LB-LD, E9BR8, E9BR8-I, E9P10I, E9P10IA, E9P15I, E9P15IA, SE9BR8, SE9BR8-I, SE9P10I, SE9P10IA, SE9P15I, SE9P15IA		
<b>accessories for</b>	359050		
	<b>Part No.</b>	510302	<b>Ref. No.</b> —
	O-ring EPDM ID ø 12.42mm thickness 1.78mm Qty 1 pcs		
	<b>Part No.</b>	511505	<b>Ref. No.</b> —
	O-ring EPDM thickness 1.78mm ID ø 12.42mm Qty 10 pcs		

screw-on/push-on fit

light bulbs

for ovens

			
1			
<b>Part No.</b>	359610	<b>Ref. No.</b>	23155100
<b>description</b>	light bulb t.max. 300°C socket E14 15W 230V ø 22mm L 47mm lens L 20mm for oven lamp type Philips		
<b>For models:</b>	E4F+FCDB, E4F+FCDQ8, FPE12TURBO, FPE6TURBO, FPG12, FPG6, G4F+FCDB, G4F+FSD8, PASTRY-EM, PASTRY-VIP-EMU, SNACK-E, SNACK-E-LS, WAV1-2, WAV2-3, WAV2-GAS, WAV3-GAS, WAV-E12, WAV-E1-2, WAV-E12T, WAV-E12TURBO, WAV-E20, WAV-E2-3, WAV-E5U, WAV-E6, WAV-E6T, WAV-E6TURBO, WAV-G12, WAV-G20, WAV-G5U, WAV-G6		





PHILIPS



1

<b>Part No.</b>	359612	<b>Ref. No.</b>	23155300
<b>description</b>	light bulb t.max. 300°C socket E14 25W 230V ø 25mm L 56mm lens L 30mm for oven lamp type Philips		
<b>For models:</b>	FME06M, FME10, FME10EP, FME10M, FME20, FME20M, FME6, FMG10, FMG10EP, FMG10M, FMG20, FMG20M, FMG6, FMG6EP, FMG6M, MM06EA, MM06EB, MM06GA, MM06GB, MM10EA, MM10EB, MM-10GA, MM10GB, MM2-3EA, MM2-3EB		

## halogen lamp

for socket G4 / G6.35 / G9



1

<b>Part No.</b>	359599	<b>Ref. No.</b>	10307
<b>description</b>	halogen lamp socket G4 12V 20W temp.-resist. 500°C		
<b>For models:</b>	FC200GB		

## oven lamps

## universal oven lamps

mounting diameter 35.5mm



1

<b>Part No.</b>	359701	<b>Ref. No.</b>	23158600	
<b>description</b>	lamp socket socket E14 220-230V mounting ø 35.5mm connection male faston 6.3mm 15W			
<b>For models:</b>	E4F+FCD8, E4F+FCDQ8, FPE12TURBO, FPE6TURBO, FPG12, FPG6, G4F+FCD8, G4F+FSD8, WAV1-2, WAV2-3, WAV2-GAS, WAV3-GAS, WAV-E12, WAV-E1-2, WAV-E12T, WAV-E12TURBO, WAV-E20, WAV-E2-3, WAV-E5U, WAV-E6, WAV-E6T, WAV-E6TURBO, WAV-G12, WAV-G20, WAV-G5U, WAV-G6			
<b>accessories for</b>	359701			
	<b>Part No.</b>	359705	<b>Ref. No.</b>	—
	oven lamp glass thr.ø 33.5mm ø 52mm hard glas temp.-resist. 350°C			
	<b>Part No.</b>	359709	<b>Ref. No.</b>	23160700
	oven lamp glass thr.ø 33.5mm ø 42mm hard glas temp.-resist. 350°C			
	<b>Part No.</b>	359721	<b>Ref. No.</b>	23602800
	gasket silicone ED ø 48mm ID ø 39.5mm thickness 5mm Qty 1 pcs			
	<b>Part No.</b>	359942	<b>Ref. No.</b>	—
	oven lamp glass thr.ø 33.5mm ø 41mm hard glas temp.-resist. 350°C			



1

<b>Part No.</b>	359709	<b>Ref. No.</b>	23160700
<b>description</b>	oven lamp glass thr.ø 33.5mm ø 42mm hard glas temp.-resist. 350°C		
<b>For models:</b>	FPE12TURBO, FPE6TURBO, FPG12, FPG6, G4F+FCD8, G4F+FSD8, WAV1-2, WAV2-3, WAV2-GAS, WAV3-GAS, WAV-E12, WAV-E1-2, WAV-E12T, WAV-E12TURBO, WAV-E2-3, WAV-E5U, WAV-E6, WAV-E6T, WAV-E6TURBO, WAV-G12, WAV-G5U, WAV-G6		



1

<b>Part No.</b>	359721	<b>Ref. No.</b>	23602800
<b>description</b>	gasket silicone ED ø 48mm ID ø 39.5mm thickness 5mm Qty 1 pcs		
<b>For models:</b>	FC100EM, FC100EP, FC100GEP, FC100GM, FC200EA, FC200EB, FC-200GA, FC200GB, FC60EM, FC60EP, FC60GEP, FC60GM, FPE12TURBO, FPE6TURBO, FPG12, FPG6, WAV-E12, WAV-E12T, WAV-E12TURBO, WAV-E5U, WAV-E6, WAV-E6T, WAV-E6TURBO, WAV-G12, WAV-G5U, WAV-G6		

55x70mm



1

<b>Part No.</b>	359297	<b>Ref. No.</b>	10306 24289500	
<b>description</b>	frame L 95mm W 81mm mounting distance 68/83mm thickness 6mm			
<b>For models:</b>	FC100EM, FC100EP, FC100GEP, FC100GM, FC200EA, FC200EB, FC200GA, FC200GB, FC60EM, FC60EP, FC60GEP, FC60GM, PASTRY-EM, PASTRY-VIP-EMU, WAV-G5U			
<b>accessories for</b>	359297			
	<b>Part No.</b>	359299	<b>Ref. No.</b>	10304
	gasket L 91mm W 77mm hole ø 3mm for oven lamp			



1

<b>Part No.</b>	359299	<b>Ref. No.</b>	10304
<b>description</b>	gasket L 91mm W 77mm hole ø 3mm for oven lamp		
<b>For models:</b>	WAV-G5U		

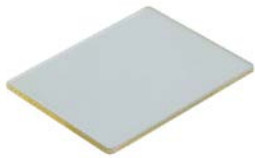

			
1			
<b>Part No.</b>	359296	<b>Ref. No.</b>	10305
<b>description</b>	lamp glass L 74mm W 58mm thickness 3mm		
<b>For models:</b>	WAV-G5U		

55x100mm

			
1			
<b>Part No.</b>	359698	<b>Ref. No.</b>	25159500
<b>description</b>	lamp socket L 100mm W 55mm socket E14 connection male faston 6.3mm		
<b>For models:</b>	FME06M, FME10, FME10EP, FME10M, FME20, FME20M, FME6, FMG10, FMG10EP, FMG10M, FMG20, FMG20M, FMG6, FMG6EP, FMG6M, MM06EA, MM06EB, MM06GA, MM06GB, MM10EA, MM10EB, MM-10GA, MM10GB, MM2-3EA, MM2-3EB		
<b>spare parts for</b>	359698		
	<b>Part No.</b>	358119	<b>Ref. No.</b> —
	frame L 118mm W 72mm mounting distance 143mm for bulb socket		
	<b>Part No.</b>	358122	<b>Ref. No.</b> —
	gasket L 112mm W 68mm silicone thickness 3mm for bulb socket		
	<b>Part No.</b>	358123	<b>Ref. No.</b> —
	lamp glass L 112mm W 68mm		
	<b>Part No.</b>	359612	<b>Ref. No.</b> 23155300
	light bulb t.max. 300°C socket E14 25W 230V ø 25mm L 56mm lens L 30mm for oven lamp type Philips		
	<b>Part No.</b>	359714	<b>Ref. No.</b> 25597400
	gasket for bulb socket		
	<b>Part No.</b>	359715	<b>Ref. No.</b> 25589200
	lamp glass L 110mm W 65mm thickness 5mm		
	<b>Part No.</b>	359716	<b>Ref. No.</b> 25806900
	frame for bulb socket		
<b>accessories for</b>	359698		
	<b>Part No.</b>	359612	<b>Ref. No.</b> 23155300
	light bulb t.max. 300°C socket E14 25W 230V ø 25mm L 56mm lens L 30mm for oven lamp type Philips		
	<b>Part No.</b>	359938	<b>Ref. No.</b> —
	borosilicate glass L 115mm W 69mm		

			
1			
<b>Part No.</b>	359716	<b>Ref. No.</b>	25806900
<b>description</b>	frame for bulb socket		
<b>For models:</b>	FME06M, FME10, FME10EP, FME10M, FME20, FME20M, FME6, FMG10, FMG10EP, FMG10M, FMG20, FMG20M, FMG6, FMG6EP, FMG6M, MM06EA, MM06EB, MM06GA, MM06GB, MM10EA, MM10EB, MM-10GA, MM10GB, MM2-3EA, MM2-3EB, WAV-E20, WAV-G20		

			
1			
<b>Part No.</b>	359714	<b>Ref. No.</b>	25597400
<b>description</b>	gasket for bulb socket		
<b>For models:</b>	FME06M, FME10, FME10EP, FME10M, FME20, FME20M, FME6, FMG10, FMG10EP, FMG10M, FMG20, FMG20M, FMG6, FMG6EP, FMG6M, MM06EA, MM06EB, MM06GA, MM06GB, MM10EA, MM10EB, MM-10GA, MM10GB, MM2-3EA, MM2-3EB, WAV-E20, WAV-G20		

			
1			
<b>Part No.</b>	359715	<b>Ref. No.</b>	25589200
<b>description</b>	lamp glass L 110mm W 65mm thickness 5mm		
<b>For models:</b>	FME06M, FME10, FME10EP, FME10M, FME20, FME20M, FME6, FMG10, FMG10EP, FMG10M, FMG20, FMG20M, FMG6, FMG6EP, FMG6M, MM06EA, MM06EB, MM06GA, MM06GB, MM10EA, MM10EB, MM-10GA, MM10GB, MM2-3EA, MM2-3EB, WAV-E20, WAV-G20		











			
1			
<b>Part No.</b>	359698	<b>Ref. No.</b>	25159500
<b>description</b>	lamp socket L 100mm W 55mm socket E14 connection male faston 6.3mm		
<b>For models:</b>	FME06M, FME10, FME10EP, FME10M, FME20, FME20M, FME6, FMG10, FMG10EP, FMG10M, FMG20, FMG20M, FMG6, FMG6EP, FMG6M, MM06EA, MM06EB, MM06GA, MM06GB, MM10EA, MM10EB, MM-10GA, MM10GB, MM2-3EA, MM2-3EB		
<b>spare parts for</b>	359698		
	<b>Part No.</b>	358119	<b>Ref. No.</b> —
	frame L 118mm W 72mm mounting distance 143mm for bulb socket		
	<b>Part No.</b>	358122	<b>Ref. No.</b> —
	gasket L 112mm W 68mm silicone thickness 3mm for bulb socket		
	<b>Part No.</b>	358123	<b>Ref. No.</b> —
	lamp glass L 112mm W 68mm		

Table continues overleaf





spare parts for 359698			
	<b>Part No.</b>	359612	Ref. No. 23155300
light bulb t.max. 300°C socket E14 25W 230V ø 25mm L 56mm lens L 30mm for oven lamp type Philips			
	<b>Part No.</b>	359714	Ref. No. 25597400
gasket for bulb socket			
	<b>Part No.</b>	359715	Ref. No. 25589200
lamp glass L 110mm W 65mm thickness 5mm			
	<b>Part No.</b>	359716	Ref. No. 25806900
frame for bulb socket			
accessories for 359698			
	<b>Part No.</b>	359612	Ref. No. 23155300
light bulb t.max. 300°C socket E14 25W 230V ø 25mm L 56mm lens L 30mm for oven lamp type Philips			
	<b>Part No.</b>	359938	Ref. No. —
borosilicate glass L 115mm W 69mm			

## producer-specific oven lamps

## BERTO'S

	1		
<b>Part No.</b>	359840	<b>Ref. No.</b>	40863
<b>description</b>	frame for oven lamp		

	1		
<b>Part No.</b>	359297	<b>Ref. No.</b>	10306 24289500
<b>description</b>	frame L 95mm W 81mm mounting distance 68/83mm thickness 6mm		
<b>For models:</b>	FC100EM, FC100EP, FC100GEP, FC100GM, FC200EA, FC200EB, FC200GA, FC200GB, FC60EM, FC60EP, FC60GEP, FC60GM, PASTRY-EM, PASTRY-VIP-EMU, WAV-G5U		
accessories for 359297			
	<b>Part No.</b>	359299	Ref. No. 10304
gasket L 91mm W 77mm hole ø 3mm for oven lamp			

	1		
<b>Part No.</b>	359299	<b>Ref. No.</b>	10304
<b>description</b>	gasket L 91mm W 77mm hole ø 3mm for oven lamp		
<b>For models:</b>	WAV-G5U		

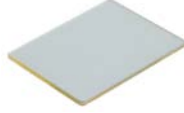
	1		
<b>Part No.</b>	359296	<b>Ref. No.</b>	10305
<b>description</b>	lamp glass L 74mm W 58mm thickness 3mm		
<b>For models:</b>	WAV-G5U		

	1		
<b>Part No.</b>	359839	<b>Ref. No.</b>	10867
<b>description</b>	lamp socket socket G4 for halogen lamp		

## lamps

## light bulbs

	1		
<b>Part No.</b>	359610	<b>Ref. No.</b>	23155100
<b>description</b>	light bulb t.max. 300°C socket E14 15W 230V ø 22mm L 47mm lens L 20mm for oven lamp type Philips		
<b>For models:</b>	E4F+FCD8, E4F+FCDQ8, FPE12TURBO, FPE6TURBO, FPG12, FPG6, G4F+FCD8, G4F+FSD8, PASTRY-EM, PASTRY-VIP-EMU, SNACK-E, SNACK-E-LS, WAV1-2, WAV2-3, WAV2-GAS, WAV3-GAS, WAV-E12, WAV-E1-2, WAV-E12T, WAV-E12TURBO, WAV-E20, WAV-E2-3, WAV-E5U, WAV-E6, WAV-E6T, WAV-E6TURBO, WAV-G12, WAV-G20, WAV-G5U, WAV-G6		

	1		
<b>Part No.</b>	359612	<b>Ref. No.</b>	23155300
<b>description</b>	light bulb t.max. 300°C socket E14 25W 230V ø 25mm L 56mm lens L 30mm for oven lamp type Philips		
<b>For models:</b>	FME06M, FME10, FME10EP, FME10M, FME20, FME20M, FME6, FMG10, FMG10EP, FMG10M, FMG20, FMG20M, FMG6, FMG6EP, FMG6M, MM06EA, MM06EB, MM06GA, MM06GB, MM10EA, MM10EB, MM-10GA, MM10GB, MM2-3EA, MM2-3EB		

## halogen lamps

## for socket G4 / G6.35 / G9

	1 <b>500°C</b>		
<b>Part No.</b>	359599	<b>Ref. No.</b>	10307
<b>description</b>	halogen lamp socket G4 12V 20W temp.-resist. 500°C		
<b>For models:</b>	FC200GB		



sockets

G4 / G5,3 / G6,35



<b>Part No.</b>	359646	<b>Ref. No.</b>	10308
<b>description</b>	lamp socket socket G4/G5.3/G6.35 24V ø 17mm H 15mm connection cable 130mm mounting distance 26mm for halogen lamp holder length 31mm cable length 130mm		

timers



programme timers





<b>Part No.</b>	360339	<b>Ref. No.</b>	10042
<b>description</b>	timer FIBER P25 engines 1 chambers 1 operation time 20s 230V shaft ø 6x4.6mm shaft L 20mm manuf. no. P255J01C1N4 motor type M51BJ0R6400		
<b>spare parts for</b>	360339		
	<b>Part No.</b>	360673	<b>Ref. No.</b> —
	motor kit pinion ø 6.8mm teeth 15 230V voltage AC 50/60Hz turn direction clockwise motor ø 48mm H 18.5mm motor type UDS-40NE1RNZ165 cable length 150mm with holder		

mechanical timers



<b>Part No.</b>	350028	<b>Ref. No.</b>	30082100
<b>description</b>	timer G 2-pole operation time 15min impulse mechanical 2NO at 250V 16A permanent position no shaft ø 3.5 x 3.5mm shaft 3.5x3.5mm shaft L 17mm mounting distance 28mm mounting thread M8 connection lateral		
<b>For models:</b>	12T, 4TO, 6T		
<b>accessories for</b>	350028		
	<b>Part No.</b>	110365	<b>Ref. No.</b> —
	knob switch zero mark t.max.°C ø 44mm shaft ø 3.5x3.5mm shaft flat black		
	<b>Part No.</b>	110371	<b>Ref. No.</b> —
	dial plate graduation 15min permanent position no rotation 30-330° ø 60mm timers knob ø 45mm		



<b>Part No.</b>	350003	<b>Ref. No.</b>	23078700
<b>description</b>	timer M2 with bell 2-pole operation time 120min impulse mechanical 2NO at 250V 16A permanent position no shaft ø 6x4.6mm shaft 6x4.6mm shaft L 23mm mounting distance 28mm connection lateral		
<b>For models:</b>	FPE12TURBO, FPE6TURBO, FPG12, FPG6, WAV1-2, WAV2-3, WAV2-GAS, WAV3-GAS, WAV-E12, WAV-E12T, WAV-E12TURBO, WAV-E20, WAV-E5U, WAV-E6, WAV-E6T, WAV-E6TURBO, WAV-G12, WAV-G20, WAV-G5U, WAV-G6		
<b>accessories for</b>	350003		
	<b>Part No.</b>	110366	<b>Ref. No.</b> —
	knob switch zero mark t.max.°C ø 44mm shaft ø 6x4.6mm shaft flat upper black		
	<b>Part No.</b>	111199	<b>Ref. No.</b> —
	dial plate graduation 120min permanent position no rotation 0-330° ø 60mm timers knob ø 45mm		



<b>Part No.</b>	350008	<b>Ref. No.</b>	25078600
<b>description</b>	timer M2 with bell 2-pole operation time 120min impulse mechanical 2NO at 250V 16A permanent position yes shaft ø 6x4.6mm shaft 6x4.6mm shaft L 24mm mounting distance 28mm connection lateral		
<b>For models:</b>	FC100EM, FC100GM, FC200EB, FC200GB, FC60EM, FC60GM, FME06M, FME10M, FME20M, FMG10M, FMG20M, FMG6, FMG6M, MM06EB, MM06GB, MM10EB, MM10GB		

alarm devices

alarm units



<b>Part No.</b>	350081	<b>Ref. No.</b>	25078900
<b>description</b>	alarm device 9-15VDC H 14.5mm wall-mounted version 75dB protection IPx0		
<b>For models:</b>	FME10, FME15, FME20, FME5, FMG10, FMG15, FMG20, FMG5, FPE12TURBO, FPE6TURBO, FPG12, FPG6, FVE, WAV-E12, WAV-E12T, WAV-E12TURBO, WAV-E20, WAV-E6, WAV-E6T, WAV-E6TURBO, WAV-G12, WAV-G6		



## buzzers



1

<b>Part No.</b>	350050	<b>Ref. No.</b>	25079300
<b>description</b>	buzzer 230VAC connection male faston 6.3mm screw mounting thread M4 60dB		
<b>For models:</b>	FC100EM, FC100GEP, FC100GM, FC200EB, FC200GA, FC200GB, FC60EM, FC60GEP, FC60GM, FME06M, FME10M, FME20M, FMG10M, FMG20M, FMG6, FMG6M, FPE12TURBO, FPE6TURBO, FPG12, FPG6, MM06EA, MM06EB, MM06GA, MM06GB, MM10EA, MM10EB, MM10GA, MM10GB, WAV-E12, WAV-E12T, WAV-E12TURBO, WAV-E20, WAV-E6, WAV-E6T, WAV-E6TURBO, WAV-G12, WAV-G6		

## contactors

## GENERAL ELECTRIC (AEG)

## power contactors



1

<b>Part No.</b>	380238	<b>Ref. No.</b>	22105200
<b>description</b>	power contactor resistive load 20A 230VAC (AC3/400V) 8.4A/4kW main contacts 3NO auxiliary contacts 1NO connection screw connection type LS0510A type AEG LS0510A type GE MC1A 310A		
<b>For models:</b>	EGRM4, EGRS4		



1

<b>Part No.</b>	380244	<b>Ref. No.</b>	22105100 23105900
<b>description</b>	power contactor resistive load 25A 230VAC (AC3/400V) 9A/4kW main contacts 3NO auxiliary contacts 1NO connection screw connection type AEG LS4K 10A type GE CL00A 310		
<b>For models:</b>	E10+10MB6, E10B4, E6PL60B, E6PL60M, E7F30-8B, E7F30-8BP, E7F30-8M, E7F30-8MP, E9BR8, E9BR8-I, E9P10D, E9P10I, E9P10IA, E9P15D, E9P15I, E9P15IA, E9PL40M, E9PL80M, SE9BR8, SE9BR8-I, SE9F18-4M, SE9F18-8M, SE9P10I, SE9P10IA, SE9P15I, SE9P15IA, SE9PL40M, SE9PL80M		

## relays

## power relays

## with bracket mounting



1

<b>Part No.</b>	380702	<b>Ref. No.</b>	31060300 31060400 31081810
<b>description</b>	power relays FINDER 230VAC 16A 3NO connection male faston 6.3mm flange dimensions 36x38x68mm manuf. no. 62.83.8.230.0300 230V		
<b>For models:</b>	E9P2MP-VTR, E9P4MP-VTR, E9P4P-VTR+FE, E9P4P-VTR+FE1, LXE9P2PVTR, LXE9P4P-VTR, SE9P2MP-VTR, SE9P4MP-VTR, SE9P4P-VTR+FE		



1



<b>Part No.</b>	380900	<b>Ref. No.</b>	31081000
<b>description</b>	power relays FINDER 230VAC 20A 1NO/1NC connection F6.3 bracket mounting dimensions 36.5x32.2x51.8mm manuf. no. 65.31.8.230.0000 2-pole		

## with male contacts

## female contact 2.0mm



1

<b>Part No.</b>	380642	<b>Ref. No.</b>	25080600
<b>description</b>	power relays 230VAC connection 2.0 plug-in connection		
<b>For models:</b>	MM06EB, MM06GB, MM10EB, MM10GB, MM2-3EB		
<b>accessories for</b>	380642		
	<b>Part No.</b>	380378	<b>Ref. No.</b> 10509
	relay socket 2-pole 55/85 dimensions 70.5x30x27mm 250V voltage AC 10A FINDER manuf. no. 94.72		
	<b>Part No.</b>	380384	<b>Ref. No.</b> —
	relay socket 2-pole contacts male faston 2.8mm 250V voltage AC 10A W 23mm for		
	<b>Part No.</b>	380399	<b>Ref. No.</b> —
	relay socket 4-pole dimensions 76.2x27x86.1mm 250V voltage AC 1A FINDER manuf. no. 94.94.3		



1

<b>Part No.</b>	380377	<b>Ref. No.</b>	10507
<b>description</b>	power relays FINDER 220-240VAC 10A 2CO connection F2 plug-in connection manuf. no. 55.32.8.230.0000 94.92.3 250V		
<b>accessories for</b>	380377		
	<b>Part No.</b>	380341	<b>Ref. No.</b> —
	relay socket 4-pole contacts 12 300V voltage AC 6A Italiana Relè manuf. no. ZMD4		
	<b>Part No.</b>	380378	<b>Ref. No.</b> 10509
	relay socket 2-pole 55/85 dimensions 70.5x30x27mm 250V voltage AC 10A FINDER manuf. no. 94.72		
	<b>Part No.</b>	380384	<b>Ref. No.</b> —
	relay socket 2-pole contacts male faston 2.8mm 250V voltage AC 10A W 23mm for		
	<b>Part No.</b>	380399	<b>Ref. No.</b> —
	relay socket 4-pole dimensions 76.2x27x86.1mm 250V voltage AC 1A FINDER manuf. no. 94.94.3		

relay sockets

1

<b>Part No.</b>	380641	<b>Ref. No.</b>	25998000
<b>description</b>	relay socket		
<b>For models:</b>	MM06EB, MM06GB, MM10EB, MM10GB, MM2-3EB		

1

<b>Part No.</b>	380378	<b>Ref. No.</b>	10509
<b>description</b>	relay socket 2-pole 55/85 dimensions 70.5x30x27mm 250V voltage AC 10A FINDER manuf. no. 94.72		
<b>accessories for</b>	380378		
	<b>Part No.</b>	380804	<b>Ref. No.</b> —
	support bracket		

1

<b>Part No.</b>	380638	<b>Ref. No.</b>	25998400
<b>description</b>	relay socket 8-pole dimensions 51x41x23mm 250V 10A FINDER manuf. no. 90.26		
<b>For models:</b>	MM2-3EB		

level relays

GICAR

1

<b>Part No.</b>	401224	<b>Ref. No.</b>	10532
<b>description</b>	level relay 230V connection F6.3 type RL30/3ES/F/G		

time relays

time relays

1

<b>Part No.</b>	380329	<b>Ref. No.</b>	10508
<b>description</b>	time relay FIBER 85.02.8.240 time range 0.05s - 100h 230-240VAC 10A mounting measurements 20.6x27.7mm 2CO connection 2.0		
<b>accessories for</b>	380329		
	<b>Part No.</b>	380378	<b>Ref. No.</b> 10509
	relay socket 2-pole 55/85 dimensions 70.5x30x27mm 250V voltage AC 10A FINDER manuf. no. 94.72		
	<b>Part No.</b>	380803	<b>Ref. No.</b> —
	relay socket 2-pole dimensions 76.2x27x86.1mm 250V voltage AC 10A FINDER manuf. no. 94.92.3		



1

<b>Part No.</b>	380639	<b>Ref. No.</b>	25081400
<b>description</b>	time relay TECHNOLOGIC RTR12DS06S time range 6s 230VAC 5A mounting measurements 34x34mm 1CO connection plug-in connection round 8-pole		
<b>For models:</b>	MM06EB, MM06GB, MM10EB, MM10GB		
<b>accessories for</b>	380639		
	<b>Part No.</b>	380638	<b>Ref. No.</b> 25998400
	relay socket 8-pole dimensions 51x41x23mm 250V 10A FINDER manuf. no. 90.26		



1

<b>Part No.</b>	380640	<b>Ref. No.</b>	25081600
<b>description</b>	time relay TECHNOLOGIC RTR12DS60S time range 60s 230VAC 5A 1CO connection plug-in connection round 8-pole		
<b>For models:</b>	MM06EB, MM06GB, MM10EB, MM10GB		
<b>accessories for</b>	380640		
	<b>Part No.</b>	380638	<b>Ref. No.</b> 25998400
	relay socket 8-pole dimensions 51x41x23mm 250V 10A FINDER manuf. no. 90.26		

## transformers

### open transformers

#### with clamp terminal



1

<b>Part No.</b>	401229	<b>Ref. No.</b>	10324
<b>description</b>	transformer primary 230V secondary 12V 63VA		
<b>For models:</b>	FC200GB		

## encapsulated transformers

### PMA



1

<b>Part No.</b>	379196	<b>Ref. No.</b>	24164600
<b>description</b>	transformer primary 230VAC secondary 12VAC 10VA secondary 0.8A connection screw 50Hz		
<b>For models:</b>	FPE10C, FPE10D, FPE12TURBO, FPE15C, FPE15D, FPE5C, FPE5D, FPE-6TURBO, FPG10C, FPG10D, FPG12, FPG15C, FPG15D, FPG5C, FPG5D, FPG6, WAV-E12, WAV-E12T, WAV-E12TURBO, WAV-E20, WAV-E6, WAVE6T, WAV-E6TURBO, WAV-G12, WAV-G6		



1

<b>Part No.</b>	379054	<b>Ref. No.</b>	25164500
<b>description</b>	transformer primary 230VAC secondary 12VAC 3VA secondary 0.25A H 40mm L 45mm W 50mm connection screw 50/60Hz type 153/M		
<b>For models:</b>	FC100EM, FC200EB, FC200GB, FME06M, FME10M, FME20M, FMG10M, FMG20M, FMG6, FMG6M, FPE12TURBO, FPE6TURBO, FPG12, FPG6, MM06EA, MM06EB, MM10EA, MM10EB, WAV-E12, WAV-E12T, WAV-E12TURBO, WAV-E20, WAV-E6, WAV-E6T, WAV-E6TURBO, WAV-G12, WAV-G6		

## electronic controllers

### EVCO - EVERY CONTROL

#### universal controllers

#### built-in version



1

<b>Part No.</b>	379589	<b>Ref. No.</b>	25982800
<b>description</b>	electronic controller EVERY CONTROL mounting measurements 71x29mm built-in depth 64mm 12V voltage AC Pt100/TC (J,K,S) protection IP54 for oven type FK401A front measurements 33x75mm		
<b>For models:</b>	FME06M, FME10M, FME20M, FMG10M, FMG20M, FMG6, FMG6M, FPE12TURBO, FPE6TURBO, FPG12, FPG6, MM06EB, MM10EB, WAV-E12, WAV-E12T, WAV-E12TURBO, WAV-E20, WAV-E6, WAV-E6T, WAV-E6TURBO, WAV-G12, WAV-G6		
<b>accessories for</b>	379589		
	<b>Part No.</b>	378009	<b>Ref. No.</b> —
	temperature probe thermocouple K (NiCr-Ni) cable silicone probe -50 up to 1150°C cable -50 up to +180°C connection 2-wire thread 1/8" probe ø3x200mm cable length 1m		

Table continues overleaf



accessories for 379589			
<b>Part No.</b>	379000	<b>Ref. No.</b>	—
temperature probe thermocouple J (Fe-CuNi) cable red/blue cable length 0.7m probe ø 2mm probe L 2000mm			
<b>Part No.</b>	379050	<b>Ref. No.</b>	24076500
temperature probe Pt100 cable Vetrotex probe -200 up to +600°C cable -50 up to +350°C probe ø6x100mm cable length 2.7m without screw connection 3-wire			

## SHANGFANG

### accessories

			
<b>Part No.</b>	379054	<b>Ref. No.</b>	25164500
description transformer primary 230VAC secondary 12VAC 3VA secondary 0.25A H 40mm L 45mm W 50mm connection screw 50/60Hz type 153/M			
<b>For models:</b> FC100EM, FC200EB, FC200GB, FME06M, FME10M, FME20M, FMG10M, FMG20M, FMG6, FMG6M, FPE12TURBO, FPE6TURBO, FPG12, FPG6, MM06EA, MM06EB, MM10EA, MM10EB, WAV-E12, WAV-E12T, WAV-E12TURBO, WAV-E20, WAV-E6, WAV-E6T, WAV-E6TURBO, WAV-G12, WAV-G6			

## probes

### universal probes

#### temperature probes

			
<b>Part No.</b>	379050 <sup>1</sup>	<b>Ref. No.</b>	24076500
description temperature probe Pt100 cable Vetrotex probe -200 up to +600°C cable -50 up to +350°C probe ø6x100mm cable length 2.7m without screw connection 3-wire			
<b>For models:</b> FPE12TURBO, FPE6TURBO, FPG12, FPG6, WAV-E12, WAV-E12T, WAV-E12TURBO, WAV-E20, WAV-E6, WAV-E6T, WAV-E6TURBO, WAV-G12, WAV-G6			

<sup>1</sup>3-wire

### producer-specific probes

#### probes

			
<b>Part No.</b>	402154	<b>Ref. No.</b>	N/A
description temperature probe Pt100 cable silicone probe -100 up to 450°C cable -50 up to +180°C connection 3-wire thread 1/8" probe ø6x35mm cable length 1.5m			

### core probes

			
<b>Part No.</b>	379945	<b>Ref. No.</b>	25919300
description core temperature probe Pt100 cable PTFE probe -40 up to +250°C cable -40 up to +250°C connection plug probe ø3.5x100mm thread cable length 0.5m handle ø 10mm handle length 80mm			
<b>For models:</b> FME10M, FME20M, FMG10M, FMG20M, FPE12TURBO, FPG12, MM10EA, MM10EB, MM10GA, WAV-E12, WAV-E12T, WAV-E12TURBO, WAV-E20, WAV-G12			

			
<b>Part No.</b>	379946	<b>Ref. No.</b>	25919100
description core temperature probe Pt100 cable PTFE probe -40 up to +250°C cable -40 up to +250°C connection plug probe ø3.5x100mm thread cable length 0.7m handle ø 10mm handle length 80mm			

			
<b>Part No.</b>	379947	<b>Ref. No.</b>	10405
description core temperature probe Pt100 cable PTFE probe -40 up to +250°C cable -40 up to +250°C connection plug probe ø3.5x100mm thread cable length 1.2m handle ø 10mm handle length 80mm			
<b>For models:</b> FC200GB			

			
<b>Part No.</b>	379350 <sup>1</sup>	<b>Ref. No.</b>	70404
description core temperature probe PTC 1kOhm cable silicone probe -40 up to +120°C cable -50 up to +180°C connection plug probe ø4x100mm thread cable length 1.7m handle ø 8mm handle length 120/35mm L1 120mm L2 130mm			

<sup>1</sup>multipoint probe



1

<b>Part No.</b>	379662 <sup>1</sup>	<b>Ref. No.</b>	70402A
<b>description</b>	core temperature probe PTC 1kOhm cable silicone probe -40 up to +120°C cable -50 up to +180°C connection plug probe ø4x70mm thread cable length 1.3m handle ø 16mm handle length 120mm L1 120mm L2 130mm		

<sup>1</sup> multipoint probe



1

<b>Part No.</b>	379806 <sup>1</sup>	<b>Ref. No.</b>	70405A
<b>description</b>	core temperature probe PTC 1kOhm cable silicone probe -40 up to +120°C cable -50 up to +180°C connection plug probe ø5x70mm thread cable length 1.2m handle ø 16mm handle length 125mm L1 170mm L2 65mm		

<sup>1</sup> multipoint probe



1

<b>Part No.</b>	379948	<b>Ref. No.</b>	25918900
<b>description</b>	core temperature probe thermocouple J (Fe-CuNi) cable SS corrugated hose probe -40 up to +250°C cable -40 up to +250°C connection 1/8" probe ø3.5x100mm thread 1/8" cable length 1.8m handle ø 10mm handle length 80mm		
<b>For models:</b>	FME6, FMG10M, FMG6, FMG6EP		



1

<b>Part No.</b>	379951	<b>Ref. No.</b>	25919500
<b>description</b>	temperature probe thermocouple J (Fe-CuNi) cable SS corrugated hose probe -40 up to +250°C cable -40 up to +250°C connection 2-wire probe ø3.5x100mm thread 1/8" cable length 2.1m handle ø 10mm handle length 80mm		
<b>For models:</b>	FME10, FME10EP, FME20, FMG10, FMG10EP, FMG20		

## electronics

### PCBs

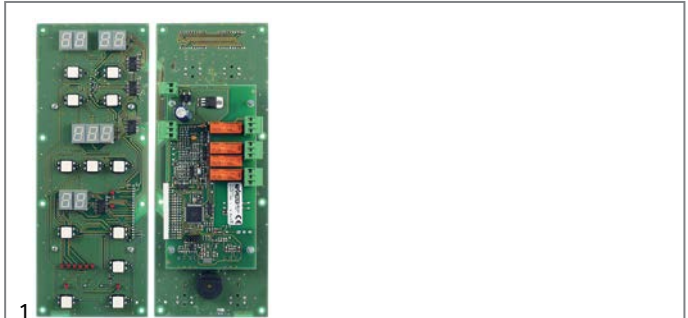

1

<b>Part No.</b>	401219	<b>Ref. No.</b>	24047900
<b>description</b>	keypad PCB convection oven FC06/12/20		
<b>For models:</b>	FPE12TURBO, FPE6TURBO, FPG12, FPG6, WAV-E12, WAV-E12T, WAV-E12TURBO, WAV-E20, WAV-E6, WAV-E6T, WAV-E6TURBO, WAV-G12, WAV-G6		

## solenoid valves

### solenoid valves (water)



1

<b>Part No.</b>	374021	<b>Ref. No.</b>	23116900
<b>description</b>	solenoid valve double straight 230VAC inlet 3/4" outlet 10mm DN10 RPE		
<b>For models:</b>	FME06M, FME10, FME10EP, FME10M, FME20, FME20M, FME6, FMG10, FMG10EP, FMG10M, FMG20, FMG20M, FMG6, FMG6EP, FMG6M, WAV-E20, WAV-G20		





1

<b>Part No.</b>	374017	<b>Ref. No.</b>	23116200
<b>description</b>	solenoid valve single straight 230VAC inlet 3/4" outlet 10mm input 6l/min DN10 RPE polyamide flow regulating valve inlet white membranes NBR pressure range 0.2-10bar		
<b>For models:</b>	FC100EM, FC100EP, FC100GEP, FC100GM, FC200EA, FC200EB, FC-200GA, FC200GB, FC60EM, FC60EP, FC60GEP, FC60GM, FPE12TURBO, FPE6TURBO, FPG12, FPG6, MM06EA, MM06EB, MM06GA, MM06GB, MM10EA, MM10EB, MM10GA, MM10GB, MM2-3EA, MM2-3EB, PASTRY-EM, PASTRY-VIP-EMU, WAV-E12, WAV-E12T, WAV-E12TURBO, WAV-E5U, WAV-E6, WAV-E6T, WAV-E6TURBO, WAV-G12, WAV-G5U, WAV-G6		



reducers			
outlet side			
			
1			
<b>Part No.</b>	371269	<b>Ref. No.</b>	25932200
<b>description</b>	reducer flow rate 0.07-0.14l/min brown		
<b>For models:</b>	MM06EA, MM06GA, MM06GB, MM10EA, MM10GA, MM10GB, PASTRY-EM, PASTRY-VIP-EMU		

			
1			
<b>Part No.</b>	371266	<b>Ref. No.</b>	25932400
<b>description</b>	reducer flow rate 0.2l/min red		
<b>For models:</b>	FC100EM, FC100EP, FC100GEP, FC100GM, FC200EA, FC200EB, FC200GA, FC200GB, FC60EM, FC60EP, FC60GEP, FC60GM, FME06M, FME10, FME10EP, FME10M, FME20, FME20M, FME6, FMG10, FMG10EP, FMG10M, FMG20, FMG20M, FMG6, FMG6EP, FMG6M, WAV-E20, WAV-G20		

			
1			
<b>Part No.</b>	371268	<b>Ref. No.</b>	25932800
<b>description</b>	reducer flow rate 0.32-0.42l/min green		
<b>For models:</b>	FME10, FME10EP, FME10M, FME20, FME20M, FMG10, FMG10EP, FMG10M, FMG20, FMG20M, FMG6, FMG6EP, FMG6M		

## ball valves electric

			
1			
<b>Part No.</b>	401233	<b>Ref. No.</b>	10036
<b>description</b>	ball valve inlet 1/2" IT outlet 1/2" IT 230V 50/60Hz mode of operation electric W 60mm H 99mm cable 4-pole 2.5W 4-pole duty cycle 50%		

## pressure switches

### for steam control

			
1			
<b>Part No.</b>	541025	<b>Ref. No.</b>	31917000
<b>description</b>	pressure control pressure connection vertical steam control pressure range adjustable 0.2-0.9bar connection male faston 6.3mm pressure connection ø 1/4"mm		
<b>For models:</b>	E7PI, G7PI		

## electrodes

			
1			
<b>Part No.</b>	401225	<b>Ref. No.</b>	3680
<b>description</b>	level electrode M12 ET - 1/8" ET total length 124/127/139mm probe L 91/95/104mm insulated probe length 42mm set 3-piece connection male faston 6.3mm ø 2.5mm		

			
1			
<b>Part No.</b>	401226	<b>Ref. No.</b>	3681
<b>description</b>	level electrode M12x1 total length 150/160/171mm probe L 117/127/138mm insulated probe length 20mm set 3-piece connection male faston 6.3mm ø 2.5mm		



			
1			
<b>Part No.</b>	401227	<b>Ref. No.</b>	3683
<b>description</b>	level electrode M12x1 total length 80/86/98mm probe L 48/53/65mm insulated probe length 20mm set 3-piece connection male faston 6.3mm ø 2.5mm		

			
1			
<b>Part No.</b>	401228	<b>Ref. No.</b>	3572
<b>description</b>	level electrode total length 175mm connection male faston 6.3mm ø 2.5mm		

## fans

### axial fans

#### import

			
1			
<b>Part No.</b>	601080 <sup>1</sup>	<b>Ref. No.</b>	10724
<b>description</b>	axial fan L 119mm W 119mm H 38mm 230VAC 50/60Hz 23/20W bearing ball bearing connection male faston 2.8mm metal ADDA fan wheel ø 110mm temp.-resist. 70°C		
<b>For models:</b>	FC200GB		
<b>accessories for</b>	601080		
	<b>Part No.</b>	550898	<b>Ref. No.</b>
			—
	<b>Part No.</b>	692519	<b>Ref. No.</b>
			—
	guard L 120mm W 120mm plastic		

<sup>1</sup>with ball bearings



hot air motors



1

<b>Part No.</b>	550854	<b>Ref. No.</b>	0691
<b>description</b>	counterflange for fan motor ED $\phi$ 60mm int. $\phi$ 1 34.5mm int. $\phi$ 2 24.6mm thickness 5.1mm brass		
<b>For models:</b>	FC200GB		

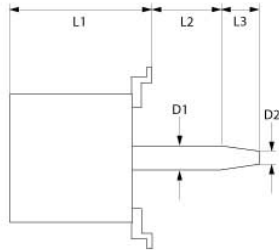

1

<b>Part No.</b>	601046	<b>Ref. No.</b>	24119100
<b>description</b>	fan motor 220/380V 3 phase 50/60Hz 0.75kW 1350/1650rpm speeds 1 L1 185mm L2 42mm L3 47mm D1 $\phi$ 24mm D2 $\phi$ 20mm M12L IT 1.9/3.3A Cos(fi) 0.83 at 50Hz 200-240/346-415V at 60Hz 200-277/346-480V at 50Hz 1350rpm at 60Hz 1650rpm type ST80/4 no. 661512		
<b>For models:</b>	FC100EM, FC100EP, FC100GEP, FC100GM, FC200EA, FC200EB, FC200GA, FC200GB, FME10M, FME20M, FMG10M, FMG20M, FPE10A, FPE10B, FPE10C, FPE10D, FPE12TURBO, FPE15A, FPE15B, FPE15C, FPE15D, FPG10A, FPG10B, FPG10C, FPG10D, FPG12, FPG15A, FPG15B, FPG15C, FPG15D, MM10EA, MM10EB, MM10GA, MM10GB, WAV-E12T, WAV-E12TURBO, WAV-E20, WAV-G12		

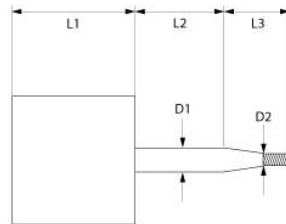

1

<b>Part No.</b>	601043	<b>Ref. No.</b>	23118300
<b>description</b>	fan motor 220-240V 1 phase 50Hz 0.37/0.07kW 0.1/0.5HP 1400/2700rpm speeds 2 L1 123mm L2 107mm L3 15mm D1 $\phi$ 15mm D2 $\phi$ 12mm M10L ET 2/0.7A suitable capacitor 20 $\mu$ F/250V at 50Hz 1400/2700rpm type 1057		
<b>For models:</b>	WAV-E5U, WAV-G5U		
<b>accessories for</b>	601043		
<b>Part No.</b>	365019	<b>Ref. No.</b>	—
<b>description</b>	operating capacitor capacity 20 $\mu$ F 400V tolerance 5% 50/60Hz ambient temperature max. -25 to +85°C $\phi$ 39.5mm L 70mm M8 plastic connection male faston 6.3mm 16.10.25. protection		

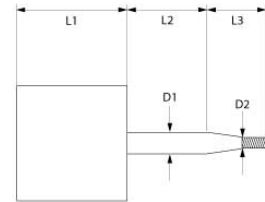

1

<b>Part No.</b>	601166	<b>Ref. No.</b>	24118500
<b>description</b>	fan motor 220-240V 1 phase 50Hz 0.37kW 2700rpm speeds 1 L1 123mm L2 77mm L3 30mm D1 $\phi$ 15mm D2 $\phi$ 12mm M10L ET 2A suitable capacitor 12.5 $\mu$ F/450V at 50Hz 2700rpm type 1057.2157		
<b>For models:</b>	FC60EM, FC60EP, FC60GEP, FC60GM, FPE6TURBO, WAV-E6TURBO		
<b>spare parts for</b>	601166		
<b>Part No.</b>	365014	<b>Ref. No.</b>	—
<b>description</b>	operating capacitor capacity 12.5 $\mu$ F 450V tolerance 5%Hz ambient temperature max. -25 to +85°C $\phi$ 35mm L 70mm M8 plastic connection male faston 6.3mm 45S.C3DS.12.5 protection		
<b>accessories for</b>	601166		
<b>Part No.</b>	601165	<b>Ref. No.</b>	—
<b>description</b>	fan wheel D1 $\phi$ 160mm H1 60mm blades 15 D2 $\phi$ 16mm D3 $\phi$ 16mm H2 29mm		

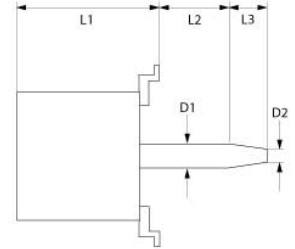

1

<b>Part No.</b>	500652	<b>Ref. No.</b>	0841
<b>description</b>	fan motor 380-415V 3 phase 50Hz 0.13/0.55kW 700/1350rpm speeds 2 L1 188mm L2 44mm L3 48mm D1 $\phi$ 24mm D2 $\phi$ 20mm M12L ITA Cos(fi) 0.13/0.55 at 50Hz 700/1350rpm 4P/8P type FB80 4/8 no. 390133		



1

<b>Part No.</b>	601067	<b>Ref. No.</b>	25647200
<b>description</b>	fan wheel D1 $\phi$ 150mm H1 38mm blades 36 D2 $\phi$ 6mm D3 $\phi$ 6mm H2 14mm		
<b>For models:</b>	MM2-3EA, MM2-3EB, PASTRY-VIP-EMU		



1			
<b>Part No.</b>	601060	<b>Ref. No.</b>	24646500
<b>description</b>	fan wheel D1 ø 180mm H1 60mm blades 16 D2 ø 11mm D3 ø 16mm H2 30mm		
<b>For models:</b>	FME06M, FME6, FMG10M, FMG6, FMG6EP, FMG6M, FPE5A, FPE5B, FPE5C, FPE5D, FPE6TURBO, FPG5A, FPG5B, FPG5C, FPG5D, FPG6, MM06EA, MM06EB, MM06GA, MM06GB, WAV-E6T, WAV-E6TURBO, WAV-G6		

1			
<b>Part No.</b>	601224	<b>Ref. No.</b>	24646900
<b>description</b>	fan wheel D1 ø 300mm H1 100mm blades 24 D2 ø 19.5mm D3 ø 23mm H2 46mm		
<b>For models:</b>	FC200EA, FC200EB, FC200GA, FC200GB		

1			
<b>Part No.</b>	601063	<b>Ref. No.</b>	0759
<b>description</b>	fan wheel D1 ø 350mm H1 100mm blades 24 D2 ø 19.5mm D3 ø 23mm H2 46mm		
<b>For models:</b>	FC200GB		

1			
<b>Part No.</b>	550852	<b>Ref. No.</b>	0690
<b>description</b>	flange for fan motor ED ø 60mm int. ø 1 28.5mm int. ø 2 24.5mm thickness 3.5mm brass		
<b>For models:</b>	FC200GB		

1			
<b>Part No.</b>	550853	<b>Ref. No.</b>	0688
<b>description</b>	gasket for fan motor ID ø 24mm ED ø 29mm thickness 3mm		
<b>For models:</b>	FC200GB		

hot air fans

miscellaneous

1			
<b>Part No.</b>	601054	<b>Ref. No.</b>	23117700
<b>description</b>	hot air fan 220-240V 32W 50/60Hz L1 60mm L2 10mm L3 25mm L4 87mm fan wheel ø 150mm FIME type C20X0E01/46		
<b>For models:</b>	E4F+FCD8, E4F+FCDQ8, E6P4+FE1, E6P6+FE1, E6P6+TE, E6PQ2H6+-FE1, E6PQ2H6+FE1+T, E6PQ2P9+FE1, E6PQ2P9+TE, E7P4+FE1, E7P4-VTR+FE1, E7P6+FE1, E7PQ4+FE1, E7PQ4+FE1+T, E7PQ6+FE1, E7PQ6+FE1+T, E9P4+FE1, E9P4P-VTR+FE1, E9P4-VTR+FE1, E9P6+FE1, E9PQ4+FE1, E9PQ4+FE1+T, E9PQ6+FE1, E9PQ6+FE1+T, G4F+FCD8, G4S+FCGN, G6F2H6+FE1, G6F2H9+FE1, G6F2H9+TE, G6F2P6+FE1, G6F2P9+FE1, G6F2P9+TE, G6F3H12+FE1, G6F3H12+TE, G6F4+FE1, G6F4+FE1+A4, G6F4PW+FE1, G6F4PW+FE1+AE, G6F6+FE1, G6F6+FE1+A6, G6F6+TE, G6F6+TE+A6, G6F6PW+FE1, G6F6PW+FE1+AE, G6F6PW+TE, G6F6PW+TE+AE, G6S+FCGN, G7F4+FE1, G7F4E+FE1, G7F4E+FE1+A4...(Other models you can see in the webshop)		
<b>spare parts for</b>	601054		
	<b>Part No.</b>	601441	<b>Ref. No.</b> —
	fan wheel ø 150mm W 25mm shaft intake ø 6x5mm stainless steel blades 7		
<b>accessories for</b>	601054		
	<b>Part No.</b>	550879	<b>Ref. No.</b> —
	insulation ø 130mm thickness 3mm hole ø 20mm for hot air fan		

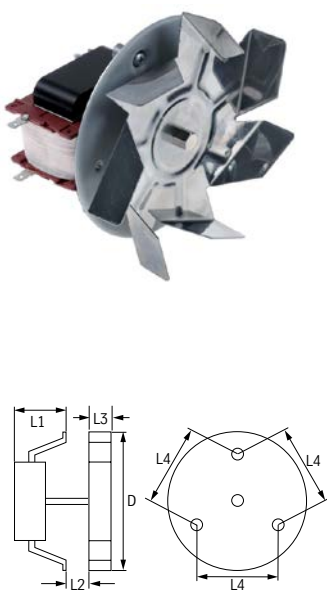
1

<b>Part No.</b>	601125	<b>Ref. No.</b>	23118000
<b>description</b>	hot air fan 220-240V 45W 50/60Hz L1 70mm L2 11mm L3 25mm L4 87mm fan wheel ø 150mm FIME type C30R0479CLF		
<b>For models:</b>	PASTRY-EM, WAV-E2-3		
<b>accessories for</b>	601125		
	<b>Part No.</b>	550879	<b>Ref. No.</b> —
	insulation ø 130mm thickness 3mm hole ø 20mm for hot air fan		

## pumps

### drain pumps

#### ASKOLL



1

<b>Part No.</b>	500565	<b>Ref. No.</b>	25115600
<b>description</b>	drain pump 30W		
<b>For models:</b>	FME06M, FME10, FME10EP, FME10M, FME20, FME20M, FME6, FMG10, FMG10EP, FMG10M, FMG20, FMG20M, FMG6, FMG6EP, FMG6M		

## electric accessories

### terminals

#### connection terminals with screw/faston connections



1

<b>Part No.</b>	550411	<b>Ref. No.</b>	30184200
<b>description</b>	power terminal block 6-pole max. 40A max 450V connection ø6mm <sup>2</sup> / F6.3 temp.-resist. 150°C cross section 6mm <sup>2</sup>		
<b>For models:</b>	CPE40, E2FQS4, E2FS4, E4F+FCD8, E4F+FCDQ8, E4FD8, E4FDQ8, E6CP6B, E6CP6M, E6CPM, E6F10-3B, E6F10-3BS, E6F10-3M, E6F10-3MS, E6F10-6B, E6F10-6BS, E6F10-6M, E6F10-6MS, E6F8-3B, E6F8-3M, E6F8-6B, E6F8-6M, E6FL3B, E6FL3BP, E6FL3B-P, E6FL3BP-CR, E6FL3BPSX, E6FL3B-SX, E6FL3M, E6FL3MP, E6FL3M-P, E6FL3MP-CR, E6FL3MPSX, E6FL3M-SX, E6FL6B-2, E6FL6B-2-SX, E6FL6BP-2, E6FL6BP-2-CR, E6FL6BP-2-SX, E6FL6M-2, E6FL6M-2-SX, E6FL6MP-2, E6FL6MP-2-CR, E6FL6MP-2-SX, E6FM6B-2, E6FM6BP-2, E6FM6M-2, E6FM6MP-2, E6FR3B, E6FR3BP...(Other models you can see in the webshop)		

## gas taps

### PEL

#### 20S series







1

<b>Part No.</b>	101094	<b>Ref. No.</b>	22272900
<b>description</b>	gas tap PEL type 20S gas inlet M16x1.5 (tube ø 10mm) bypass nozzle ø 0.35mm gas outlet M16x1.5 (tube ø 10/8mm) thermocouple connection M8x1 pilot connection shaft ø 8x6.5mm shaft L 22/15mm shaft flat lower		
<b>spare parts for</b>	101094		
	<b>Part No.</b>	100408	<b>Ref. No.</b> —
	bypass nozzle type PEL20/21 bore ø 0.35mm thread M5x0.5		
	<b>Part No.</b>	101060	<b>Ref. No.</b> —
	magnet unit standard L 39mm D1 ø 15.4mm D2 ø 11mm suitable for PEL20-21/JUNKERS/EGA		
	<b>Part No.</b>	101205	<b>Ref. No.</b> —
	gas tap front part shaft ø 8x6.5mm shaft L 22/15mm shaft flat upper/lower suitable for PEL20		
	<b>Part No.</b>	101230	<b>Ref. No.</b> —
	thermocouple nut T1: M8x1 T2: M18x1 aluminium		
<b>accessories for</b>	101094		
	<b>Part No.</b>	101278	<b>Ref. No.</b> 32777300
	olive for pipe ø 10mm Qty 1 pcs		
	<b>Part No.</b>	101300	<b>Ref. No.</b> —
	union nut thread M16x1.5 tube ø 10mm		

Table continues overleaf







accessories for		101094		
	<b>Part No.</b>	101450	Ref. No.	—
olive for pipe ø 8mm L 12.7mm Qty 1 pcs ED ø 10mm				
	<b>Part No.</b>	101451	Ref. No.	—
union nut thread M16x1.5 tube ø 8mm				
	<b>Part No.</b>	110081	Ref. No.	31875900
knob ø 70mm shaft ø 8x6.5mm shaft flat universal				
	<b>Part No.</b>	110083	Ref. No.	—
knob dial plate gas tap without ignition flame silver				





21S series









1

<b>Part No.</b>	101095	<b>Ref. No.</b>	22783600
<b>description</b>	gas tap PEL type 21S gas inlet M16x1.5 (tube ø 10mm) bypass nozzle ø 0.35mm gas outlet M16x1.5 (tube ø 10/8mm) thermocouple connection M8x1 pilot connection M10x1 shaft ø 8x6.5mm shaft L 22/15mm shaft flat lower		
<b>For models:</b>	G6F2BH6, G6F2BP6, G6F2BPW, G6F2H6+FE1, G6F2H6+FG1, G6F2H9+FE1, G6F2H9+FG1, G6F2H9+T, G6F2H9+TE, G6F2MH6, G6F2MP6, G6F2MPW, G6F2P6+FE1, G6F2P6+FG1, G6F2P9+FE1, G6F2P9+FG1, G6F2P9+T, G6F2P9+TE, G6F4BPW, G6F4MPW, G6F4PW+FE1, G6F4PW+FG1, G6F6+T, G6F6+T+A6, G6F6BPW, G6F6MPW, G6F6PW+FE1, G6F6PW+FG1, G6F6PW+T, G6F6PW+T+AE, G6F6PW+TE, G6F6PW+TE+AE, G7F2B, G7F2BPW, G7F2M, G7F2MPW, G7F4+FE, G7F4+FE1, G7F4+FES, G7F4+FG, G7F4+FG1, G7F4B, G7F-4BPW, G7F4M, G7F4MPW, G7F4PW+FE, G7F4PW+FE1, G7F4PW+FG, G7F4PW+FG1, G7F6+FE...(Other models you can see in the webshop)		

spare parts for		101095		
	<b>Part No.</b>	100408	Ref. No.	—
bypass nozzle type PEL20/21 bore ø 0.35mm thread M5x0.5				
	<b>Part No.</b>	101060	Ref. No.	—
magnet unit standard L 39mm D1 ø 15.4mm D2 ø 11mm suitable for PEL20-21/JUNKERS/EGA				
	<b>Part No.</b>	101206	Ref. No.	—
gas tap front part shaft ø 8x6.5mm shaft L 22/15mm shaft flat upper/lower suitable for PEL21				
	<b>Part No.</b>	101230	Ref. No.	—
thermocouple nut T1: M8x1 T2: M18x1 aluminium				





accessories for		101095		
	<b>Part No.</b>	100908	Ref. No.	—
union screw thread M10x1 for pipe ø 4mm Qty 1 pcs				
	<b>Part No.</b>	100909	Ref. No.	—
union screw thread M10x1 for pipe ø 6mm Qty 1 pcs				
	<b>Part No.</b>	101246	Ref. No.	31777500 31777700
olive for pipe ø 4mm Qty 1 pcs				
	<b>Part No.</b>	101278	Ref. No.	32777300
olive for pipe ø 10mm Qty 1 pcs				

accessories for		101095		
	<b>Part No.</b>	101286	Ref. No.	—
olive ID ø 6mm Qty 1 pcs				
	<b>Part No.</b>	101300	Ref. No.	—
union nut thread M16x1.5 tube ø 10mm				
	<b>Part No.</b>	101450	Ref. No.	—
olive for pipe ø 8mm L 12.7mm Qty 1 pcs ED ø 10mm				
	<b>Part No.</b>	101451	Ref. No.	—
union nut thread M16x1.5 tube ø 8mm				
	<b>Part No.</b>	110081	Ref. No.	31875900
knob ø 70mm shaft ø 8x6.5mm shaft flat universal				
	<b>Part No.</b>	112206	Ref. No.	—
knob dial plate silver gas tap PEL21/22/23 t.max.°C ED ø 63mm ID ø 45.5mm				



1

<b>Part No.</b>	101397	<b>Ref. No.</b>	22273500 31273700
<b>description</b>	gas tap PEL type 21S gas inlet M16x1.5 (tube ø 10mm) bypass nozzle ø 0.35mm gas outlet M16x1.5 (tube ø 10/8mm) thermocouple connection M9x1 pilot connection M10x1 shaft ø 8x6.5mm shaft L 22/15mm shaft flat lower		
<b>For models:</b>	CPG40, CPG40E, CPG80, CPG80E, E9F15-4M, E9F15-8M, E9F18-4M, E9F18-8M, G6CP6, G6F2BH6, G6F2BP6, G6F2BPW, G6F2MH6, G6F2MP6, G6F2MPW, G6F4BPW, G6F4MPW, G6F4PW+FE1, G6F4PW+FG1, G6F6BPW, G6F6MPW, G6F6PW+FE1, G6F6PW+FG1, G6F6PW+T, G6F6PW+TE, G6FL3B, G6FL3B-CR, G6FL3B-SX, G6FL3M, G6FL3M-CR, G6FL3M-SX, G6FL6B, G6FL6B-CR, G6FL6B-SX, G6FL6M, G6FL6M-CR, G6FL6M-SX, G6FM6B, G6FM6M, G6FR3B, G6FR3M, G6FR6B, G6FR6M, G6PL60B, G6PL60M, G7F2B, G7F2BPW, G7F2M, G7F2MPW, G7F4+FE...(Other models you can see in the webshop)		

spare parts for		101397		
	<b>Part No.</b>	100408	Ref. No.	—
bypass nozzle type PEL20/21 bore ø 0.35mm thread M5x0.5				
	<b>Part No.</b>	101060	Ref. No.	—
magnet unit standard L 39mm D1 ø 15.4mm D2 ø 11mm suitable for PEL20-21/JUNKERS/EGA				
	<b>Part No.</b>	101206	Ref. No.	—
gas tap front part shaft ø 8x6.5mm shaft L 22/15mm shaft flat upper/lower suitable for PEL21				
	<b>Part No.</b>	101231	Ref. No.	—
thermocouple nut T1: M9x1 T2: M18x1				



accessories for		101397		
	<b>Part No.</b>	100908	Ref. No.	—
union screw thread M10x1 for pipe ø 4mm Qty 1 pcs				
	<b>Part No.</b>	100909	Ref. No.	—
union screw thread M10x1 for pipe ø 6mm Qty 1 pcs				

Table continues overleaf



accessories for		101397		
	<b>Part No.</b>	101246	Ref. No.	31777500 31777700
olive for pipe ø 4mm Qty 1 pcs				
	<b>Part No.</b>	101278	Ref. No.	32777300
olive for pipe ø 10mm Qty 1 pcs				
	<b>Part No.</b>	101286	Ref. No.	—
olive ID ø 6mm Qty 1 pcs				
	<b>Part No.</b>	101300	Ref. No.	—
union nut thread M16x1.5 tube ø 10mm				
	<b>Part No.</b>	101450	Ref. No.	—
olive for pipe ø 8mm L 12.7mm Qty 1 pcs ED ø 10mm				
	<b>Part No.</b>	101451	Ref. No.	—
union nut thread M16x1.5 tube ø 8mm				
	<b>Part No.</b>	110081	Ref. No.	31875900
knob ø 70mm shaft ø 8x6.5mm shaft flat universal				
	<b>Part No.</b>	112206	Ref. No.	—
knob dial plate silver gas tap PEL21/22/23 t.max.°C ED ø 63mm ID ø 45.5mm				











	1			
<b>Part No.</b>	107582	<b>Ref. No.</b>	31273500	
<b>description</b>	gas tap PEL type 21S gas inlet M16x1.5 (tube ø 10mm) bypass nozzle ø 0.45mm gas outlet M16x1.5 (tube ø 10/8mm) thermocouple connection M9x1 pilot connection M10x1 shaft ø 8x6.5mm shaft L 22/15mm shaft flat upper			
<b>For models:</b>	G12F4H9+FGP, G12F4H9M, G6F2B, G6F2B+A2, G6F2BH9, G6F2BP9, G6F2H6+FE1, G6F2H6+FG1, G6F2H9+FE1, G6F2H9+FG1, G6F2H9+TE, G6F2H9+TE, G6F2MH9, G6F2MP9, G6F2P6+FE1, G6F2P6+FG1, G6F2P9+FE1, G6F2P9+FG1, G6F2P9+TE, G6F2P9+TE, G6F3BH12, G6F3BH9, G6F3H12+FE1, G6F3H12+FG1, G6F3H12+T, G6F3H12+TE, G6F3H9+T, G6F3MH12, G6F4B, G6F4B+A4, G6F6B, G6F6B+A6, G6FL3B, G6FL6B, G6FM6B, G6FR3B, G6FR6B, G7F2BP, G7F2M, G7F2MP, G7F4+FE1, G7F4+FG, G7F4+FG1, G7F4BP, G7F4M, G7F4MP, G7F4P+FG, G7F4P+FG+AF2... (Other models you can see in the webshop)			

	1		
<b>Part No.</b>	107581	<b>Ref. No.</b>	31273600
<b>description</b>	gas tap PEL type 21S gas inlet M16x1.5 (tube ø 10mm) bypass nozzle ø 0.55mm gas outlet M16x1.5 (tube ø 10/8mm) thermocouple connection M9x1 pilot connection M10x1 shaft ø 8x6.5mm shaft L 22/15mm shaft flat upper		
<b>For models:</b>	G12F4H9+FGP, G12F4H9M, G12F4P9+FGP, G12F4P9M, G6F2B, G6F-2B+A2, G6F2BH9, G6F2BP9, G6F2H6+FE1, G6F2H6+FG1, G6F2H9+FE1, G6F2H9+FG1, G6F2H9+T, G6F2H9+TE, G6F2MH9, G6F2MP9, G6F2P6+FE1, G6F2P6+FG1, G6F2P9+FE1, G6F2P9+FG1, G6F2P9+T, G6F2P9+TE, G6F3BH12, G6F3BH9, G6F3H12+FE1, G6F3H12+FG1, G6F3H12+T, G6F3H12+TE, G6F3H9+T, G6F3MH12, G6F4B, G6F4B+A4, G6F6B, G6F6B+A6, G6FL3B, G6FL6B, G6FM6B, G6FR3B, G6FR6B, G7F2BP, G7F2M, G7F2MP, G7F4+FE1, G7F4+FG, G7F4+FG1, G7F4BP, G7F4M, G7F4MP, G7F4P+FG, G7F4P+FG+AF2... (Other models you can see in the webshop)		



23S/O series			
	1		
<b>Part No.</b>	101092	<b>Ref. No.</b>	31274100 35273800
<b>description</b>	gas tap PEL type 23S/O gas inlet M28x1.5 (tube ø 20mm) bypass nozzle ø 0.35mm gas outlet M24x1.5 (tube ø 16mm) thermocouple connection M10x1 pilot connection M10x1 shaft ø 10x8mm shaft L 25/17mm shaft flat upper		
<b>For models:</b>	G7PD, G9P10D, G9P10DA, G9P10I, G9P10IA, G9P15D, G9P15DA, G9P15I, G9P15IA, G9P20D, G9P20DA, LXG9P15I, SG9P10D, SG9P10DA, SG9P10I, SG9P10IA, SG9P15D, SG9P15DA, SG9P15I		
<b>spare parts for</b>	101092		
	<b>Part No.</b>	100455	Ref. No. —
bypass nozzle type PEL23/24 bore ø 0.35mm thread M8x0.5			
	<b>Part No.</b>	101059	Ref. No. —
magnet unit T1: M10x1 T2: M22x1 L 46mm ø 18mm suitable for PEL23S M10x1			
	<b>Part No.</b>	101204	Ref. No. —
gas tap front part shaft ø 10x8mm shaft L 25/17mm shaft flat upper/lower suitable for PEL23S			
	<b>Part No.</b>	101244	Ref. No. —
gas connection thread M24x1.5 tube ø 12/16mm horizontal for PEL gas taps			
	<b>Part No.</b>	101463	Ref. No. —
screw suitable for PEL23S Qty 4 pcs			
	<b>Part No.</b>	528455	Ref. No. —
O-ring Viton thickness 2.62mm ID ø 18.72mm Qty 1 pcs			
<b>accessories for</b>	101092		
	<b>Part No.</b>	100908	Ref. No. —
union screw thread M10x1 for pipe ø 4mm Qty 1 pcs			





Table continues overleaf



accessories for		101092		
	<b>Part No.</b>	100909	Ref. No.	—
union screw thread M10x1 for pipe ø 6mm Qty 1 pcs				
	<b>Part No.</b>	101246	Ref. No.	31777500 31777700
olive for pipe ø 4mm Qty 1 pcs				
	<b>Part No.</b>	101252	Ref. No.	—
union nut thread M24x1.5 for pipe ø 12mm				
	<b>Part No.</b>	101253	Ref. No.	—
union nut thread M24x1.5 PEL for pipe ø 16mm				
	<b>Part No.</b>	101254	Ref. No.	—
union nut thread M28x1.5 tube ø 20mm				
	<b>Part No.</b>	101255	Ref. No.	—
olive for pipe ø 12mm Qty 1 pcs				
	<b>Part No.</b>	101256	Ref. No.	—
olive for pipe ø 16mm Qty 1 pcs				
	<b>Part No.</b>	101257	Ref. No.	—
olive for pipe ø 20mm Qty 1 pcs				
	<b>Part No.</b>	101286	Ref. No.	—
olive ID ø 6mm Qty 1 pcs				
	<b>Part No.</b>	110080	Ref. No.	—
knob ø 70mm shaft ø 10x8mm shaft flat universal				
	<b>Part No.</b>	112206	Ref. No.	—
knob dial plate silver gas tap PEL21/22/23 t.max.°C ED ø 63mm ID ø 45.5mm				

SABAF

				
1				
<b>Part No.</b>	101357	<b>Ref. No.</b>	31274500 31275000	
<b>description</b>	gas tap SABAF type 10 gas inlet pipe flange ø16mm bypass nozzle ø 0.52mm gas outlet 1/4" (tube ø 8mm) front fixing thermocouple connection plug-in connection shaft ø 8x6.5mm shaft L 26/12mm shaft flat lower			
<b>For models:</b>	G6F2B, G6F2B+A2, G6F2BPW+AE, G6F2M, G6F2M+A2, G6F2MPW+AE, G6F4+FE1, G6F4+FE1+A4, G6F4+FG1, G6F4+FG1+A4, G6F4B, G6F4B+A4, G6F4BPW+AE, G6F4M, G6F4M+A4, G6F4MPW+AE, G6F4PW+FE1+AE, G6F4PW+FG1+AE, G6F6+FE1, G6F6+FE1+A6, G6F6+FG1, G6F6+FG1+A6, G6F6+T, G6F6+T+A6, G6F6+TE, G6F6+TE+A6, G6F6B, G6F6B+A6, G6F6BPW+AE, G6F6M, G6F6M+A6, G6F6MPW+AE, G6F6PW+FE1+AE, G6F6PW+FG1+AE, G7F2BE, G7F2BE+A2, G7F2BPW+AE, G7F2BPW-F, G7F2ME, G7F2ME+A2, G7F2MPW+AE, G7F4BE, G7F4BE+A4, G7F4BPW+AE, G7F4E+FE, G7F4E+FE+A4, G7F4E+FE1, G7F4E+FE1+A4, G7F4E+FG, G7F4E+FG+A4...(Other models you can see in the webshop)			
<b>spare parts for</b>		101357		
	<b>Part No.</b>	101376	Ref. No.	22594900
gasket ID ø 8mm ED ø 12mm H 3/5mm				

<b>spare parts for</b>		101357		
	<b>Part No.</b>	106723	Ref. No.	—
magnet unit L 29mm D1 ø 12.5mm D2 ø 8.5mm suitable for SABAF				
<b>accessories for</b>		101357		
	<b>Part No.</b>	101277	Ref. No.	—
olive ID ø 8mm Qty 1 pcs				
	<b>Part No.</b>	101751	Ref. No.	22966200
bracket				
	<b>Part No.</b>	520656	Ref. No.	—
union nut thread 1/4" tube ø 6/8mm				
	<b>Part No.</b>	560082	Ref. No.	—
hexagonal screw thread M4 thread L 16mm SS WS 7 Qty 20 pcs DIN 933 / ISO 4017				

gas thermostats







SIT





630 Eurosit series

				
1				
<b>Part No.</b>	101992	<b>Ref. No.</b>	35271800 35271809	
<b>description</b>	gas thermostat type 630 Eurosit series t.max. 190°C 110-190°C gas inlet 3/8" gas outlet 3/8" thermocouple connection M9x1 pilot connection M10x1 probe ø 4mm probe L 202mm capillary pipe 1050mm SIT			
<b>For models:</b>	6GL18B, 6GL18M, 9GL15+15M, 9GL15M, 9GL20+20M, 9GL20M, GL15+15M, GL15M, GL20+20M, GL20M, GL30B, GL30M, GL7+7M, S9GL20+20M, S9GL20M, S9GL22M			
<b>accessories for</b>		101992		
	<b>Part No.</b>	100904	Ref. No.	—
locking screw M10x1 for pipe ø 4mm Qty 1 pcs				
	<b>Part No.</b>	100905	Ref. No.	—
locking screw M10x1 for pipe ø 6mm Qty 1 pcs				
	<b>Part No.</b>	101273	Ref. No.	—
olive for pipe ø 12mm L 9.5mm brass Qty 1 pcs suitable for universal				
	<b>Part No.</b>	101276	Ref. No.	—
union screw thread 3/8" tube ø 12mm Qty 1 pcs				
	<b>Part No.</b>	101333	Ref. No.	—
plug thread 3/8" with O-ring				
	<b>Part No.</b>	510655	Ref. No.	—
gasket silicone ø 7.8mm L 5mm blue Shore 55° Qty 10 pcs				





			
<b>Part No.</b>	101696	<b>Ref. No.</b>	35274500
<b>description</b>	gas thermostat type 630 Eurosit series t.max. 300°C 60-300°C gas inlet 3/8" gas outlet 3/8" thermocouple connection M9x1 pilot connection M10x1 probe ø 4mm probe L 72mm capillary pipe 1050mm SIT		
<b>For models:</b>	G12F4H9+FGP, G12F4P9+FGP, G9FL4M, G9FL4M-CR, G9FL4M-SX, G9FL8M-2, G9FL8M-2-CR, G9FL8M-2-SX, G9FM8M-2, G9FR4M, G9FR8M-2, SG9FL4M-CR, SG9FL8M-2-CR, SG9FM8M-2-CR, SG-9FR4M-CR, SG9FR8M-2-CR		
<b>spare parts for</b>	101696		
	<b>Part No.</b>	101333	<b>Ref. No.</b> —
	plug thread 3/8" with O-ring		
<b>accessories for</b>	101696		
	<b>Part No.</b>	100904	<b>Ref. No.</b> —
	locking screw M10x1 for pipe ø 4mm Qty 1 pcs		
	<b>Part No.</b>	100905	<b>Ref. No.</b> —
	locking screw M10x1 for pipe ø 6mm Qty 1 pcs		
	<b>Part No.</b>	101273	<b>Ref. No.</b> —
	olive for pipe ø 12mm L 9.5mm brass Qty 1 pcs suitable for universal		
	<b>Part No.</b>	101276	<b>Ref. No.</b> —
	union screw thread 3/8" tube ø 12mm Qty 1 pcs		

			
<b>Part No.</b>	101125	<b>Ref. No.</b>	35271600
<b>description</b>	gas thermostat type 630 Eurosit series t.max. 340°C 100-340°C gas inlet 3/8" gas outlet 3/8" thermocouple connection M9x1 pilot connection M10x1 probe ø 4mm probe L 72mm capillary pipe 1050mm SIT		
<b>For models:</b>	G9BR8, G9BR8-I, LXG9BR8-I, SG9BR8, SG9BR8-I		
<b>accessories for</b>	101125		
	<b>Part No.</b>	100825	<b>Ref. No.</b> —
	gas tap spindle shaft ø 8x6.5mm shaft L 22/14mm suitable for EUROSIT		
	<b>Part No.</b>	100904	<b>Ref. No.</b> —
	locking screw M10x1 for pipe ø 4mm Qty 1 pcs		
	<b>Part No.</b>	100905	<b>Ref. No.</b> —
	locking screw M10x1 for pipe ø 6mm Qty 1 pcs		
	<b>Part No.</b>	100949	<b>Ref. No.</b> —
	gasket suitable for 630 Eurosit series		

<b>accessories for</b>	101125		
	<b>Part No.</b>	101273	<b>Ref. No.</b> —
	olive for pipe ø 12mm L 9.5mm brass Qty 1 pcs suitable for universal		
	<b>Part No.</b>	101276	<b>Ref. No.</b> —
	union screw thread 3/8" tube ø 12mm Qty 1 pcs		
	<b>Part No.</b>	101333	<b>Ref. No.</b> —
	plug thread 3/8" with O-ring		
	<b>Part No.</b>	101390	<b>Ref. No.</b> —
	gas tap spindle shaft ø 6x4.6mm shaft L 32/15mm gas tap with ignition flame suitable for ZANUSSI, MARENO for gas thermostat EUROSIT		
	<b>Part No.</b>	101392	<b>Ref. No.</b> —
	adapter suitable for 630 Eurosit series		
	<b>Part No.</b>	110357	<b>Ref. No.</b> —
	gas tap spindle shaft ø 8x6.5mm shaft L 36/12mm suitable for 630 Eurosit series		
	<b>Part No.</b>	110358	<b>Ref. No.</b> —
	adapter shaft ø 10x8mm shaft L 29/18mm suitable for 630 Eurosit series		

710 Minisit series







			
<b>Part No.</b>	101131	<b>Ref. No.</b>	32271600
<b>description</b>	gas thermostat without cap, button and angle SIT type MINISIT 710 t.max. 190°C 50-190°C gas inlet 1/2" gas outlet 3/8" thermocouple connection M9x1 pilot connection M10x1 probe ø 5mm probe L 98mm capillary pipe 1200mm probe type A2 pressure controller no pressure regulator mbar gland nut		
<b>For models:</b>	GL10+10B, GL10+10M, GL10B, GL10M, GL15+15M, GL15M, GL20+20M, GL20M, GL30M, GL8+8B, GL8+8M, GL8B, GL8M		
<b>spare parts for</b>	101131		
	<b>Part No.</b>	101053	<b>Ref. No.</b> —
	magnet unit T1: M9x1 T2: M24x1 L 45mm ø 17mm suitable for Minisit		
	<b>Part No.</b>	102103	<b>Ref. No.</b> —
	probe 60-200°C probe ø 5mm probe L 98mm capillary pipe 1050mm t.max. 200°C fryer probe type type A2 suitable for MINISIT 710		
<b>accessories for</b>	101131		
	<b>Part No.</b>	100809	<b>Ref. No.</b> —
	O-ring EPDM thickness 2mm ID ø 21mm Qty 1 pcs		
	<b>Part No.</b>	100820	<b>Ref. No.</b> —
	gland duct ET M14x1.5 IT M10x0.75 probe ø max. 6.5mm WS 22		
	<b>Part No.</b>	100904	<b>Ref. No.</b> —
	locking screw M10x1 for pipe ø 4mm Qty 1 pcs		
	<b>Part No.</b>	100905	<b>Ref. No.</b> —
	locking screw M10x1 for pipe ø 6mm Qty 1 pcs		

Table continues overleaf

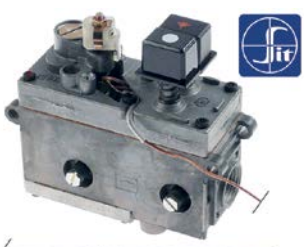

accessories for		101131		
	<b>Part No.</b>	101054	Ref. No.	—
	magnet unit T1: M10x1 T2: M24x1 L 45mm ø 17mm suitable for Minisit			
	<b>Part No.</b>	101136	Ref. No.	—
	piezoelectric igniter suitable for Minisit with cover cap ømm connection F6.3x0.8			
	<b>Part No.</b>	101137	Ref. No.	—
	cover cap without piezoelectric igniter			
	<b>Part No.</b>	101267	Ref. No.	32924100
	reducer IT 3/8" ET 1/2" L 21mm			
	<b>Part No.</b>	101268	Ref. No.	—
	gas connection thread 3/8" angled with O-ring MINISIT 710			
	<b>Part No.</b>	101269	Ref. No.	—
	gas connection thread 1/2" angled with O-ring MINISIT 710			
	<b>Part No.</b>	101270	Ref. No.	—
	screw connection IT 3/8" ET 3/8" L 28mm			
	<b>Part No.</b>	101272	Ref. No.	—
	screw connection IT 1/2" ET 3/8" L 57mm			
	<b>Part No.</b>	101273	Ref. No.	—
	olive for pipe ø 12mm L 9.5mm brass Qty 1 pcs suitable for universal			
	<b>Part No.</b>	101274	Ref. No.	—
	olive for pipe ø 16mm Qty 1 pcs			
	<b>Part No.</b>	101275	Ref. No.	—
	union screw thread 1/2" for pipe ø 16mm Qty 1 pcs			
	<b>Part No.</b>	101276	Ref. No.	—
	union screw thread 3/8" tube ø 12mm Qty 1 pcs			
	<b>Part No.</b>	110068	Ref. No.	32652600
	knob suitable for Minisit ø 37mm			

PEL



25ST series



Part No.	107933	Ref. No.	22274700
<b>description</b>	gas thermostat PEL type 25ST 100-260°C gas inlet M16x1.5 (tube ø 10mm) gas outlet M16x1.5 (tube ø 10mm) thermocouple connection M9x1 pilot connection M10x1 capillary pipe 1200mm probe ø 6mm probe L 90mm shaft ø 8x6.5mm shaft L 21/15mm shaft flat upper		
<b>For models:</b>	G6F3H12+T, G6F3H9+T, G6F6+T, G6F6+T+A6, G6F6PW+T, G6F6PW+T+AE, G7F4+FG, G7F4E+FG, G7F4E+FG+A4, G7F4P+FG, G7F4P+FG+AF2, G7F4PW+FG, G7F4PW+FG+AE, G7F6+FG, G7F6+T, G7F6E+FG, G7F6E+FG+A6, G7F6E+T, G7F6E+T, G7F6P+FG, G7F6P+FG+AF2, G7F6P+T, G7F6P+T+AF2, G7F6PW+FG, G7F6PW+FG+AE, G7F6PW+T, G7F6PW+T+AE, G7T4P4F+FG, G7TP+FG, G7TP2F+FG, G7TP2F+T, G9F4+FE1, G9F4+FG, G9F4P+FG, G9F4P+FG+AF2, G9F4PW+FG, G9F4PW+FG+AE, G9F6+FE1, G9F6+FG, G9F6+T, G9F6P+FG, G9F6P+FG+AF2, G9F6P+T, G9F6P+T+AF2, G9F6PW+FG, G9F6PW+FG+AE, G9F6PW+T, G9F6PW+T+AE, G9F8+2FG, G9F8P+2FG, G9F8P+2FG+AF2... (Other models you can see in the webshop)		



Part No.	101172	Ref. No.	22274500 22274600
<b>description</b>	gas thermostat PEL type 25ST 100-300°C gas inlet M16x1.5 (tube ø 10mm) bypass nozzle ø 0.35mm gas outlet M16x1.5 (tube ø 10/8mm) thermocouple connection M9x1 pilot connection M10x1 capillary pipe 1200mm probe ø 6mm probe L 100mm shaft ø 8x6.5mm shaft L 21/15mm shaft flat upper		
<b>For models:</b>	G6F2B, G6F2B+A2, G6F3H12+T, G6F3H9+T, G6F4B, G6F4B+A4, G6F6+T, G6F6+T+A6, G6F6B, G6F6B+A6, G6F6PW+T, G6F6PW+T+AE, G6FL3B-SX, G6FL6B-CR, G6FL6B-SX, G6FR6B, G7BR8, G7BR8-I, G7F4+FG, G7F4E+FG, G7F4E+FG+A4, G7F4P+FG, G7F4P+FG+AF2, G7F4PW+FG, G7F4PW+FG+AE, G7F6+FG, G7F6+T, G7F6E+FG, G7F6E+FG+A4, G7F6E+FG+A6, G7F6E+T, G7F6P+FG, G7F6P+FG+AF2, G7F6P+T, G7F6P+T+AF2, G7F6PW+FG, G7F6PW+FG+AE, G7F6PW+T, G7F6PW+T+AE, G7FL4B, G7FL4B-CR, G7FL4B-SX, G7FL4M, G7FL4MCR, G7FL4M-SX, G7FL8B-2, G7FL8B-2-CR, G7FL8B-2-SX, G7FL8M-2, G7FL8M-2-CR...(Other models you can see in the webshop)		

spare parts for		101172		
	<b>Part No.</b>	100259	Ref. No.	—
	bypass nozzle type PEL22 bore ø 0.35mm thread M6x0.5			
	<b>Part No.</b>	101060	Ref. No.	—
	magnet unit standard L 39mm D1 ø 15.4mm D2 ø 11mm suitable for PEL20-21/JUNKERS/EGA			
	<b>Part No.</b>	106200	Ref. No.	—
	nut thread M9x1 suitable for PEL 24/25S			











accessories for		101172		
	<b>Part No.</b>	100908	Ref. No.	—
	union screw thread M10x1 for pipe ø 4mm Qty 1 pcs			
	<b>Part No.</b>	100909	Ref. No.	—
	union screw thread M10x1 for pipe ø 6mm Qty 1 pcs			
	<b>Part No.</b>	101246	Ref. No.	31777500 31777700
	olive for pipe ø 4mm Qty 1 pcs			





Table continues overleaf



accessories for	101172		
	<b>Part No.</b>	101278	Ref. No. 32777300
	olive for pipe ø 10mm Qty 1 pcs		
	<b>Part No.</b>	101286	Ref. No. —
	olive ID ø 6mm Qty 1 pcs		
	<b>Part No.</b>	101300	Ref. No. —
	union nut thread M16x1.5 tube ø 10mm		
	<b>Part No.</b>	101450	Ref. No. —
	olive for pipe ø 8mm L 12.7mm Qty 1 pcs ED ø 10mm		
	<b>Part No.</b>	101451	Ref. No. —
	union nut thread M16x1.5 tube ø 8mm		
	<b>Part No.</b>	110079	Ref. No. —
	knob dial plate gas thermostat 1-8 silver		
	<b>Part No.</b>	110081	Ref. No. 31875900
	knob ø 70mm shaft ø 8x6.5mm shaft flat universal		

SABAF



	<b>Part No.</b>	101181	Ref. No. 22273900
	gas thermostat SABAF t.max. 300°C gas inlet pipe flange ø16mm bypass nozzle ø 0.46mm gas outlet M13x1 IT (tube ø 8mm) gas outlet 2 thermocouple connection M8x1 pilot connection capillary pipe 850mm probe ø 4mm probe L 150mm shaft ø 6x4.6mm shaft L 45/27mm shaft flat upper		
	For models: G4F+FSD8		
	spare parts for 101181		
	<b>Part No.</b>	101060	Ref. No. —
	magnet unit standard L 39mm D1 ø 15.4mm D2 ø 11mm suitable for PEL20-21/JUNKERS/EGA		
	accessories for 101181		
	<b>Part No.</b>	101277	Ref. No. —
	olive ID ø 8mm Qty 1 pcs		
	<b>Part No.</b>	101376	Ref. No. 22594900
	gasket ID ø 8mm ED ø 12mm H 3/5mm		
	<b>Part No.</b>	101477	Ref. No. —
	union screw thread M13x1 tube ø 8mm Qty 1 pcs		
	<b>Part No.</b>	101751	Ref. No. 22966200
	bracket		
	<b>Part No.</b>	110360	Ref. No. —
	knob without symbol ø 65mm shaft ø 6x4.6mm shaft flat upper black		
	<b>Part No.</b>	110603	Ref. No. —
	knob dial plate gas thermostat t.max. 300°C 90-300°C		

	<b>Part No.</b>	106742	Ref. No. 22274000
	gas thermostat SABAF t.max. 300°C gas inlet pipe flange ø16mm bypass nozzle ø 0.52mm gas outlet M13x1 IT (tube ø 8mm) gas outlet 2 thermocouple connection M8x1 pilot connection capillary pipe 850mm probe ø 4mm probe L 150mm shaft ø 6x4.6mm shaft L 45/27mm shaft flat upper		
	For models: G4S+FSGN, G6F2H6+FG1, G6F2H9+FG1, G6F2P6+FG1, G6F-2P9+FG1, G6F3H12+FG1, G6F4+FG1, G6F4+FG1+A4, G6F4PW+FG1, G6F6+FG1, G6F6+FG1+A6, G6F6PW+FG1, G6S+FSGN, G7F4+FG1, G7F4E+FG1, G7F4E+FG1+A4, G7F4P+FG1, G7F4PW+FG1, G7F4PW+FG1+AE, G7F6+FG1, G7F6E+FG1, G7F6E+FG1+A4, G7F6E+FG1+A6, G7F6P+FG1, G7F6PW+FG1, G7F6PW+FG1+AE, G7T4P2F+FG1, G7T4P4F+FG1, G7TP+FG1, G7TP2F+FG1, G9F4+FG1, G9F4E+FG1, G9F4E+FG1+A4, G9F4P+FG1, G9F4P+FG1+AF1, G9F4PW+FG1, G9F4PW+FG1+AE, G9F6+FG1, G9F6E+FG1, G9F6E+FG1+A6, G9F-6P+FG1, G9F6PW+FG1, G9F6PW+FG1+AE, G9F8+2FG1, G9F8P+2FG1, G9TP+FG1, G9TP2F+FG1		
	spare parts for 106742		
	<b>Part No.</b>	101376	Ref. No. 22594900
	gasket ID ø 8mm ED ø 12mm H 3/5mm		
	accessories for 106742		
	<b>Part No.</b>	101277	Ref. No. —
	olive ID ø 8mm Qty 1 pcs		
	<b>Part No.</b>	101477	Ref. No. —
	union screw thread M13x1 tube ø 8mm Qty 1 pcs		

gas valves and ignition boxes

gas control valves

HONEYWELL

	<b>Part No.</b>	106004	Ref. No. 11017
	gas valve type VK4105C 220-240V 50/60Hz gas inlet flange 32x32mm gas outlet flange 32x32mm thermocouple connection pilot connection pressure range 15-60mbar max 60mbar operator type pressure controller type V5306E 1234 1 suitable for HONEYWELL flange 32x32mm		
	For models: WAV-G5U		
	accessories for 106004		
	<b>Part No.</b>	102845	Ref. No. —
	gas connection angled 1/2" flange 32x32mm hole distance 24x24mm Tandem		
	<b>Part No.</b>	102846	Ref. No. —
	gas connection straight 1/2" flange 32x32mm hole distance 24x24mm suitable for Tandem		



SIT

ELETTROSIT









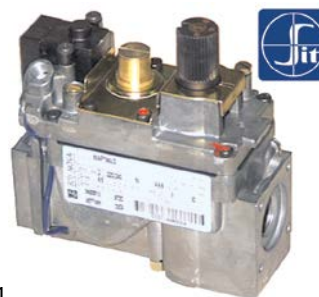



1

<b>Part No.</b>	101127	<b>Ref. No.</b>	23270900
<b>description</b>	gas valve SIT type ELETTROSIT 230V gas inlet 3/4" gas outlet 3/4" thermocouple connection M9x1 pilot connection M10x1 lateral equiv. no. 0.810.175		
<b>For models:</b>	FPG12, FPG6, WAV2-GAS, WAV-G12, WAV-G20, WAV-G5U, WAV-G6		
<b>spare parts for</b>	101127		
	<b>Part No.</b>	101312	Ref. No. 22194632
	microswitch		
	<b>Part No.</b>	101352	Ref. No. —
	solenoid coil 230V 50Hz suitable for ELETTROSIT		
<b>accessories for</b>	101127		
	<b>Part No.</b>	100006	Ref. No. —
	piezoelectric igniter suitable for ELETTROSIT body plastic blowing connection ø2.4mm ø 14mm		
	<b>Part No.</b>	100904	Ref. No. —
	locking screw M10x1 for pipe ø 4mm Qty 1 pcs		
	<b>Part No.</b>	100905	Ref. No. —
	locking screw M10x1 for pipe ø 6mm Qty 1 pcs		
	<b>Part No.</b>	101301	Ref. No. —
	gas connection thread 1/2" straight ELETTROSIT screw with O-ring		
	<b>Part No.</b>	101303	Ref. No. —
	gas connection straight thread 3/4" ELETTROSIT		
	<b>Part No.</b>	101309	Ref. No. —
	extension		

NOVASIT











1

<b>Part No.</b>	101162	<b>Ref. No.</b>	22271332 32271300
<b>description</b>	gas valve SIT series Novasit 820 230V 50Hz gas inlet 1/2" gas outlet 1/2" thermocouple connection M9x1 pilot connection M10x1 ignition pressure 3-5mbar pressure range 3-30mbar pressure regulator connection blind equiv. no. 0.820.010		
<b>For models:</b>	FMG10, FMG10EP, FMG10M, FMG20, FMG20M, FMG6, FMG6EP, FMG6M, GL10+10B8, GL10+10M8, GL10B4, GL10M4, GL15+15M8, GL15M4, GL20+20M8, GL20M4		
<b>spare parts for</b>	101162		
	<b>Part No.</b>	101065	Ref. No. —
	magnet unit with cable L 44mm D1 ø 30mm D2 ø 20mm suitable for NOVASIT		
	<b>Part No.</b>	101313	Ref. No. 22161832
	solenoid coil 230V 50Hz		
<b>accessories for</b>	101162		
	<b>Part No.</b>	100006	Ref. No. —
	piezoelectric igniter suitable for ELETTROSIT body plastic blowing connection ø2.4mm ø 14mm		
	<b>Part No.</b>	101305	Ref. No. —
	gas connection straight 1/2" flange 45x45mm ELETTROSIT/V4400/4600/4605 suitable for SIT/HONEYWELL hole distance 36x36mm		
	<b>Part No.</b>	101306	Ref. No. —
	gas connection angled flange 45x45mm hole distance 36x36mm 1/2" ELETTROSIT/V4400/4600/4605 screw with O-ring suitable for SIT/HONEYWELL		
	<b>Part No.</b>	101307	Ref. No. —
	gas connection straight flange 45x45mm hole distance 36x36mm 3/4" ELETTROSIT/V4400/4600/4605 screw with O-ring suitable for SIT/HONEYWELL		
	<b>Part No.</b>	101308	Ref. No. —
	gas connection angled flange 45x45mm hole distance 36x36mm 3/4" ELETTROSIT/V4400/4600/4605 screw with O-ring suitable for SIT/HONEYWELL		
	<b>Part No.</b>	101312	Ref. No. 22194632
	microswitch		
	<b>Part No.</b>	101314	Ref. No. 22162232
	solenoid coil 24V 50Hz		
	<b>Part No.</b>	101317	Ref. No. —
	plug with cable L 1000mm suitable for NOVASIT		
	<b>Part No.</b>	101318	Ref. No. —
	cover cap for solenoid coil suitable for NOVASIT		



1

<b>Part No.</b>	101914	<b>Ref. No.</b>	31990700
<b>description</b>	gas valve SIT series Novasit 822 230V 50Hz gas inlet 1/2" gas outlet 1/2" thermocouple connection pilot connection closed ignition pressurembar pressure range 3-30mbar pressure regulator connection blind equiv. no. 0.822.144		
<b>For models:</b>	E9P10I, E9P10IA, E9P15I, E9P15IA, G7PI, G9P10I, G9P10IA, G9P15I, G9P15IA, SE9P10I, SE9P10IA, SE9P15I, SE9P15IA, SG9P10I, SG9P10IA, SG9P15I		
<b>spare parts for</b>	101914		
	<b>Part No.</b>	101313	<b>Ref. No.</b> 22161832
	solenoid coil 230V 50Hz		
	<b>Part No.</b>	101542	<b>Ref. No.</b> —
	solenoid coil 50Hz NOVA 822/826/827 suitable for NOVASIT 230V		
<b>accessories for</b>	101914		
	<b>Part No.</b>	101305	<b>Ref. No.</b> —
	gas connection straight 1/2" flange 45x45mm ELETTROSIT/V4400/4600/4605 suitable for SIT/HONEYWELL hole distance 36x36mm		
	<b>Part No.</b>	101306	<b>Ref. No.</b> —
	gas connection angled flange 45x45mm hole distance 36x36mm 1/2" ELETTROSIT/V4400/4600/4605 screw with O-ring suitable for SIT/HONEYWELL		
	<b>Part No.</b>	101307	<b>Ref. No.</b> —
	gas connection straight flange 45x45mm hole distance 36x36mm 3/4" ELETTROSIT/V4400/4600/4605 screw with O-ring suitable for SIT/HONEYWELL		
	<b>Part No.</b>	101308	<b>Ref. No.</b> —
	gas connection angled flange 45x45mm hole distance 36x36mm 3/4" ELETTROSIT/V4400/4600/4605 screw with O-ring suitable for SIT/HONEYWELL		
	<b>Part No.</b>	101503	<b>Ref. No.</b> —
	O-ring EPDM thickness 2mm ID ø 32mm Qty 1 pcs		
	<b>Part No.</b>	101924	<b>Ref. No.</b> —
	plug with cable L 1090mm suitable for NOVA 822/826/827		

## TANDEM



1

<b>Part No.</b>	101984	<b>Ref. No.</b>	25271500
<b>description</b>	gas valve 230V 50Hz gas inlet 1/2" gas outlet 1/2" pilot connection level slow ignition ignition times pressure range 2-50mbar power supply for modulator 230VAC rectified Tandem equiv. no. 0.836.010		
<b>For models:</b>	FMG10, FMG10M, FMG6, FMG6M, MM06GA, MM06GB, MM10GA, MM10GB		
<b>spare parts for</b>	101984		
	<b>Part No.</b>	101379	<b>Ref. No.</b> —
	solenoid coil 230V 50Hz suitable for Tandem		
<b>accessories for</b>	101984		
	<b>Part No.</b>	101274	<b>Ref. No.</b> —
	olive for pipe ø 16mm Qty 1 pcs		
	<b>Part No.</b>	101275	<b>Ref. No.</b> —
	union screw thread 1/2" for pipe ø 16mm Qty 1 pcs		
	<b>Part No.</b>	101925	<b>Ref. No.</b> —
	plug with O-ring thread M10x1 for pilot burner suitable for NOVASIT		
	<b>Part No.</b>	102845	<b>Ref. No.</b> —
	gas connection angled 1/2" flange 32x32mm hole distance 24x24mm Tandem		
	<b>Part No.</b>	102846	<b>Ref. No.</b> —
	gas connection straight 1/2" flange 32x32mm hole distance 24x24mm suitable for Tandem		
	<b>Part No.</b>	102847	<b>Ref. No.</b> —
	O-ring		

## ignition boxes

### HONEYWELL



1







<b>Part No.</b>	101165	<b>Ref. No.</b>	25271700
<b>description</b>	ignition box HONEYWELL type S4560A 1008 equiv. no. S4560A 1008 electrodes 1 waiting time 0s safety time 10s 220-240V 10VA 50Hz		
<b>For models:</b>	FC100GEP, FC100GM, FC200GA, FC200GB, FC60GEP, FC60GM		
<b>spare parts for</b>	101165		
	<b>Part No.</b>	358696	<b>Ref. No.</b> —
	fine fuse size ø5x20mm 4A medium lag rated 250V Qty 10 pcs		





			
<b>Part No.</b>	102367	<b>Ref. No.</b>	25271400
<b>description</b>	ignition box HONEYWELL type S4565A 2092 1 electrodes 3 waiting times safety time 10s 220-240V 4VA 50/60Hz		
<b>For models:</b>	FMG10, FMG10M, FMG6, FMG6M, MM06GA, MM06GB, MM10GA, MM10GB		

## ignition parts

### pilot burners

<b>SIT</b>			
100 series			
			
<b>Part No.</b>	106901	<b>Ref. No.</b>	31291300
<b>description</b>	pilot burner SIT type 100 series 1 flame nozzle ø 0.2mm gas connection 6mm		
<b>For models:</b>	G12F4H9+FGP, G12F4H9M, G12F4P9+FGP, G12F4P9M, G6F2B, G6F-2B+A2, G6F2BH6, G6F2BH9, G6F2BP6, G6F2BP9, G6F2H6+FE1, G6F-2H6+FG1, G6F2H9+FE1, G6F2H9+FG1, G6F2H9+TE, G6F-2MH6, G6F2MH9, G6F2MP6, G6F2MP9, G6F2P6+FE1, G6F2P6+FG1, G6F2P9+FE1, G6F2P9+FG1, G6F2P9+T, G6F2P9+TE, G6F3BH12, G6F3BH9, G6F3H12+FE1, G6F3H12+FG1, G6F3H12+T, G6F3H12+TE, G6F3H9+T, G6F3MH12, G6F4B, G6F4B+A4, G6F6B, G6F6B+A6, G7F2B, G7F2BP, G7F2M, G7F2MP, G7F4+FE, G7F4+FE1, G7F4+FES, G7F4+FG, G7F4+FG1, G7F4B, G7F4BP, G7F4M...(Other models you can see in the webshop)		
<b>spare parts for</b>	106901		
	<b>Part No.</b>	100854	<b>Ref. No.</b> —
	pilot burner bracket double		
	<b>Part No.</b>	100916	<b>Ref. No.</b> —
	compression spring for pilot burner Qty 1 pcs		
	<b>Part No.</b>	100917	<b>Ref. No.</b> —
	gasket for pilot burner Qty 1 pcs aluminium		
	<b>Part No.</b>	100918	<b>Ref. No.</b> —
	screw for pilot burner		
<b>accessories for</b>	106901		
	<b>Part No.</b>	100904	<b>Ref. No.</b> —
	locking screw M10x1 for pipe ø 4mm Qty 1 pcs		
	<b>Part No.</b>	100905	<b>Ref. No.</b> —
	locking screw M10x1 for pipe ø 6mm Qty 1 pcs		

<b>accessories for</b>	106901		
	<b>Part No.</b>	102110	<b>Ref. No.</b> —
	pilot tube copper pipe ø 4mm thickness 1mm L 3000mm		
	<b>Part No.</b>	102111	<b>Ref. No.</b> —
	pilot tube copper pipe ø 6mm thickness 1mm L 3000mm		
	<b>Part No.</b>	102742	<b>Ref. No.</b> —
	pilot burner nozzle LPG code 25 bore ø 0.25mm Qty 1 pcs		











			
<b>Part No.</b>	106904	<b>Ref. No.</b>	31291400
<b>description</b>	pilot burner SIT type 100 series 1 flame nozzle ø 0.2mm gas connection 6mm		
<b>For models:</b>	G12F4H9+FGP, G12F4P9+FGP, G6F6+T, G6F6+T+A6, G6F6PW+T, G6F6PW+T+AE, G7F4E+FG, G7F4E+FG+A4, G7F4P+FG, G7F4PW+FG, G7F4PW+FG+AE, G7F6+T, G7F6E+FG, G7F6E+FG+A6, G7F6E+T, G7F-6P+FG, G7F6P+T, G7F6PW+FG, G7F6PW+FG+AE, G7F6PW+T, G7F-6PW+T+AE, G7T4P4F+FG, G7TP+FG, G7TP2F+T, G9F4+FG, G9F4P+FG, G9F4P+FG+AF2, G9F4PW+FG, G9F4PW+FG+AE, G9F6+FG, G9F6+T, G9F6P+FG, G9F6P+FG+AF2, G9F6P+T, G9F6PW+FG, G9F6PW+FG+AE, G9F6PW+T, G9F6PW+T+AE, G9F8+2FG, G9F8P+2FG, G9F8P+2FG+AF2, G9TP2F+FG, G9TP2F+T, G9TP4F+FG, GL18+18MI, GL18+18MI-E, GL18MI-E, SG9F6+T, SG9F6P+FG...(Other models you can see in the webshop)		
<b>spare parts for</b>	106904		
	<b>Part No.</b>	100245	<b>Ref. No.</b> —
	pilot burner nozzle LPG code 20 bore ø 0.2mm Qty 1 pcs thread M8x0.75		
	<b>Part No.</b>	100855	<b>Ref. No.</b> —
	pilot burner bracket triple		
	<b>Part No.</b>	100885	<b>Ref. No.</b> —
	air mixing sleeve for pilot burner Qty 1 pcs		
	<b>Part No.</b>	100916	<b>Ref. No.</b> —
	compression spring for pilot burner Qty 1 pcs		
	<b>Part No.</b>	100917	<b>Ref. No.</b> —
	gasket for pilot burner Qty 1 pcs aluminium		
	<b>Part No.</b>	100918	<b>Ref. No.</b> —
	screw for pilot burner		
	<b>Part No.</b>	107160	<b>Ref. No.</b> —
	pilot burner cap SIT 1 flame Hmm Lmm Qty 1 pcs		
	<b>Part No.</b>	107166	<b>Ref. No.</b> —
	pilot burner head SIT 1 flame Hmm Lmm Qty 1 pcs		
	<b>Part No.</b>	107701	<b>Ref. No.</b> —
	pilot burner bottom part SIT 100 series nozzle ø 0.2mm		
<b>accessories for</b>	106904		
	<b>Part No.</b>	100246	<b>Ref. No.</b> —
	pilot burner nozzle natural gas bore ø 0.35mm Qty 1 pcs thread M8x0.75		

Table continues overleaf



accessories for		106904		
	<b>Part No.</b>	100904	Ref. No.	—
	locking screw M10x1 for pipe ø 4mm Qty 1 pcs			
	<b>Part No.</b>	100905	Ref. No.	—
	locking screw M10x1 for pipe ø 6mm Qty 1 pcs			
	<b>Part No.</b>	102110	Ref. No.	—
	pilot tube copper pipe ø 4mm thickness 1mm L 3000mm			
	<b>Part No.</b>	102111	Ref. No.	—
	pilot tube copper pipe ø 6mm thickness 1mm L 3000mm			
	<b>Part No.</b>	107171	Ref. No.	—
	pilot burner nozzle SIT natural/liquid gas bore ø 0.25mm Qty 1 pcs			
	<b>Part No.</b>	107700	Ref. No.	—
	pilot burner bottom part SIT 100 series nozzle ø 0.25mm			
	<b>Part No.</b>	107702	Ref. No.	—
	pilot burner bottom part SIT 100 series nozzle ø 0.35mm			

				
1				
<b>Part No.</b>	106906	<b>Ref. No.</b>	22291632 25291400	
<b>description</b>	pilot burner SIT type 100 series 3 flames nozzle ø 0.2mm gas connection 6mm			
<b>For models:</b>	FMG10, FMG10EP, FMG10M, FMG20, FMG20M, FMG6, FMG6EP, FMG6M, FPG12, FPG6, G9BR8, G9BR8-I, G9P10D, G9P10DA, G9P10I, G9P10IA, G9P15D, G9P15DA, G9P15I, G9P15IA, SG9BR8, SG9BR8-I, SG9P10D, SG9P10DA, SG9P10I, SG9P10IA, SG9P15D, SG9P15DA, SG9P15I, WAV-G12, WAV-G20, WAV-G5U, WAV-G6			
<b>spare parts for</b>	106906			
	<b>Part No.</b>	100245	Ref. No.	—
	pilot burner nozzle LPG code 20 bore ø 0.2mm Qty 1 pcs thread M8x0.75			
	<b>Part No.</b>	100855	Ref. No.	—
	pilot burner bracket triple			
	<b>Part No.</b>	100885	Ref. No.	—
	air mixing sleeve for pilot burner Qty 1 pcs			
	<b>Part No.</b>	100916	Ref. No.	—
	compression spring for pilot burner Qty 1 pcs			
	<b>Part No.</b>	100917	Ref. No.	—
	gasket for pilot burner Qty 1 pcs aluminium			
	<b>Part No.</b>	100918	Ref. No.	—
	screw for pilot burner			
	<b>Part No.</b>	107162	Ref. No.	—
	pilot burner cap SIT 3 flames Hmm Lmm Qty 1 pcs			
	<b>Part No.</b>	107701	Ref. No.	—
	pilot burner bottom part SIT 100 series nozzle ø 0.2mm			

accessories for		106906		
	<b>Part No.</b>	100245	Ref. No.	—
	pilot burner nozzle LPG code 20 bore ø 0.2mm Qty 1 pcs thread M8x0.75			
	<b>Part No.</b>	100246	Ref. No.	—
	pilot burner nozzle natural gas bore ø 0.35mm Qty 1 pcs thread M8x0.75			
	<b>Part No.</b>	100904	Ref. No.	—
	locking screw M10x1 for pipe ø 4mm Qty 1 pcs			
	<b>Part No.</b>	100905	Ref. No.	—
	locking screw M10x1 for pipe ø 6mm Qty 1 pcs			
	<b>Part No.</b>	102110	Ref. No.	—
	pilot tube copper pipe ø 4mm thickness 1mm L 3000mm			
	<b>Part No.</b>	102111	Ref. No.	—
	pilot tube copper pipe ø 6mm thickness 1mm L 3000mm			
	<b>Part No.</b>	107171	Ref. No.	—
	pilot burner nozzle SIT natural/liquid gas bore ø 0.25mm Qty 1 pcs			
	<b>Part No.</b>	107700	Ref. No.	—
	pilot burner bottom part SIT 100 series nozzle ø 0.25mm			
	<b>Part No.</b>	107702	Ref. No.	—
	pilot burner bottom part SIT 100 series nozzle ø 0.35mm			

accessories

ignition electrodes

				
1 M4				
<b>Part No.</b>	100706	<b>Ref. No.</b>	22298332 23297400	
<b>description</b>	ignition electrode connection M4 Qty 1 pcs			
<b>For models:</b>	FMG10, FMG10EP, FMG10M, FMG20, FMG20M, FMG6, FMG6EP, FMG6M, FPG12, FPG6, G9BR8, G9BR8-I, GL18+18MI, GL18+18MI-E, GL18MI, GL18MI-E, SG9BR8, SG9BR8-I, WAV2-GAS, WAV-G12, WAV-G20, WAV-G5U, WAV-G6			



140 - 145 -150 series

<p>1</p>			
<b>Part No.</b>	107114 <sup>1</sup>	<b>Ref. No.</b>	22291200 31780400
<b>description</b>	pilot burner SIT type 140 series 2 flames nozzle ømm gas connectionmm		
<b>For models:</b>	G7PD, GFLD8, GFLD8-CR, GFLM6, GFLM6-CR, GFLS4, GFLS4-CR, GFRD8, GFRM6, GFRS4		
<b>spare parts for</b>	107114		
	<b>Part No.</b>	100907	<b>Ref. No.</b> —
screw connection thread M10x1 Qty 1 pcs type SEF 1 ømm for thermocouple			
<b>accessories for</b>	107114		
	<b>Part No.</b>	100204	<b>Ref. No.</b> —
pilot burner nozzle SIT LPG code 14 bore ø 0.18/0.20mm Qty 1 pcs suitable for 140 series			
	<b>Part No.</b>	100205	<b>Ref. No.</b> —
pilot burner nozzle SIT LPG code 19 bore ø 0.23/0.26mm Qty 1 pcs suitable for SIT 150 series			
	<b>Part No.</b>	100206	<b>Ref. No.</b> —
pilot burner nozzle SIT natural gas code 36 bore ø 0.60/0.55mm Qty 1 pcs suitable for SIT 150 series			
	<b>Part No.</b>	100207	<b>Ref. No.</b> —
pilot burner nozzle SIT natural gas code 27 bore ø 0.40/0.38mm suitable for SIT 140 series			
	<b>Part No.</b>	100216	<b>Ref. No.</b> —
pilot burner nozzle SIT natural gas code 38 bore ø 0.45mm Qty 1 pcs suitable for SIT 150 series			
	<b>Part No.</b>	100701	<b>Ref. No.</b> 22296900
ignition electrode connection M4 Qty 1 pcs			
	<b>Part No.</b>	100801	<b>Ref. No.</b> —
gasket for pilot burner Qty 1 pcs			
	<b>Part No.</b>	100897	<b>Ref. No.</b> —
olive for pipe ø 4mm Qty 1 pcs for pilot burner			
	<b>Part No.</b>	100898	<b>Ref. No.</b> —
olive for pipe ø 6mm Qty 1 pcs for pilot burner			
	<b>Part No.</b>	100906	<b>Ref. No.</b> —
screw connection thread M10x1 for ignition electrode brass Qty 1 pcs WS 10			
	<b>Part No.</b>	100908	<b>Ref. No.</b> —
union screw thread M10x1 for pipe ø 4mm Qty 1 pcs			
	<b>Part No.</b>	100909	<b>Ref. No.</b> —
union screw thread M10x1 for pipe ø 6mm Qty 1 pcs			
	<b>Part No.</b>	102110	<b>Ref. No.</b> —
pilot tube copper pipe ø 4mm thickness 1mm L 3000mm			
	<b>Part No.</b>	102111	<b>Ref. No.</b> —
pilot tube copper pipe ø 6mm thickness 1mm L 3000mm			

<sup>1</sup>incl. thermocouple fitting

160 series

<p>1</p>			
<b>Part No.</b>	100056	<b>Ref. No.</b>	27291100
<b>description</b>	pilot burner SIT type 160 series 3 flames nozzle ømm gas connectionmm		
<b>For models:</b>	6GL18B, 6GL18M, 9GL15+15M, 9GL15M, 9GL20+20M, 9GL20M, CPG40, CPG40E, CPG80, CPG80E, E9F15-4M, E9F15-8M, E9F18-4M, E9F18-8M, G6CP6, G6FL3B, G6FL3B-CR, G6FL3B-SX, G6FL3M, G6FL3M-CR, G6FL3M-SX, G6FL6B, G6FL6B-CR, G6FL6B-SX, G6FL6M, G6FL6M-SX, G6FM6B, G6FM6M, G6FR3B, G6FR3M, G6FR6B, G6FR6M, G6PL60B, G6PL60M, G7BM4M, G7BR8, G7BR8-I, G7FL4B, G7FL4B-CR, G7FL4B-SX, G7FL4M, G7FL4M-CR, G7FL4M-SX, G7FL8B-2, G7FL8B-2-CR, G7FL8B-2-SX, G7FL8M-2, G7FL8M-2-CR, G7FL8M-2-SX, G7FM8B-2... (Other models you can see in the webshop)		
<b>spare parts for</b>	100056		
	<b>Part No.</b>	100907	<b>Ref. No.</b> —
screw connection thread M10x1 Qty 1 pcs type SEF 1 ømm for thermocouple			
<b>accessories for</b>	100056		
	<b>Part No.</b>	100202	<b>Ref. No.</b> —
pilot burner nozzle natural gas code 41 Qty 1 pcs nozzle ø 0.41mm			
	<b>Part No.</b>	100203	<b>Ref. No.</b> —
pilot burner nozzle LPG code 25 Qty 1 pcs nozzle ø 0.25mm			
	<b>Part No.</b>	100701	<b>Ref. No.</b> 22296900
ignition electrode connection M4 Qty 1 pcs			
	<b>Part No.</b>	100801	<b>Ref. No.</b> —
gasket for pilot burner Qty 1 pcs			
	<b>Part No.</b>	100869	<b>Ref. No.</b> —
pilot burner nozzle natural gas code 51 Qty 1 pcs suitable for 160 series nozzle ø 0.51mm			
	<b>Part No.</b>	100870	<b>Ref. No.</b> —
olive for pipe ø 4mm Qty 1 pcs suitable for 160 series for pilot burner			
	<b>Part No.</b>	100906	<b>Ref. No.</b> —
screw connection thread M10x1 for ignition electrode brass Qty 1 pcs WS 10			
	<b>Part No.</b>	100908	<b>Ref. No.</b> —
union screw thread M10x1 for pipe ø 4mm Qty 1 pcs			
	<b>Part No.</b>	100909	<b>Ref. No.</b> —
union screw thread M10x1 for pipe ø 6mm Qty 1 pcs			
	<b>Part No.</b>	101287	<b>Ref. No.</b> —
olive for pipe ø 6mm Qty 1 pcs			
	<b>Part No.</b>	102110	<b>Ref. No.</b> —
pilot tube copper pipe ø 4mm thickness 1mm L 3000mm			
	<b>Part No.</b>	102111	<b>Ref. No.</b> —
pilot tube copper pipe ø 6mm thickness 1mm L 3000mm			
	<b>Part No.</b>	107650	<b>Ref. No.</b> 32366500
pilot burner nozzle SIT LPG code 30 Qty 1 pcs			

















**POLIDORO**

**pilot burners**







<b>Part No.</b>	100162	<b>Ref. No.</b>	31291500
<b>description</b>	pilot burner POLIDORO 3 flames code gas connectionmm		
<b>For models:</b>	G6F2B, G6F2B+A2, G6F4B, G6F4B+A4, G6F6B, G6F6B+A6, G7T-4P2F+FG1, G7T4P2FB, G7T4P2FM, G7T4P4F+FG, G7T4P4F+FG1, G7T-4P4FB, G7T4P4FM, G7TP+FG, G7TP+FG1, G7TP2F+FG, G7TP2F+FG1, G7TP2F+T, G7TP2FM, G7TPM, G9BR8-I, G9P10D, G9P10DA, G9P10I, G9P10IA, G9P15D, G9P15DA, G9P15I, G9P15IA, G9P20D, G9P20DA, G9TP+FG, G9TP+FG1, G9TP2F+FG, G9TP2F+FG1, G9TP2F+T, G9TP2FM, G9TP4F+FG, G9TP4FM, G9TPM, LXG9BR8-I, LXG9P15I, SG9BR8-I, SG9P10D, SG9P10DA, SG9P10I, SG9P10IA, SG9P15D, SG9P15DA, SG9P15I...(Other models you can see in the webshop)		
<b>spare parts for</b>	100162		
	<b>Part No.</b>	100907	<b>Ref. No.</b> —
	screw connection thread M10x1 Qty 1 pcs type SEF 1 ømm for thermocouple		
<b>accessories for</b>	100162		
	<b>Part No.</b>	100000	<b>Ref. No.</b> 40902200
	pilot burner nozzle POLIDORO LPG code 22 bore ø 0.22mm Qty 1 pcs		
	<b>Part No.</b>	100208	<b>Ref. No.</b> —
	pilot burner nozzle POLIDORO LPG code 20 bore ø 0.2mm Qty 1 pcs		
	<b>Part No.</b>	100209	<b>Ref. No.</b> —
	pilot burner nozzle POLIDORO natural gas code 40 bore ø 0.4mm Qty 1 pcs		
	<b>Part No.</b>	100701	<b>Ref. No.</b> 22296900
	ignition electrode connection M4 Qty 1 pcs		
	<b>Part No.</b>	100906	<b>Ref. No.</b> —
	screw connection thread M10x1 for ignition electrode brass Qty 1 pcs WS 10		
	<b>Part No.</b>	100907	<b>Ref. No.</b> —
	screw connection thread M10x1 Qty 1 pcs type SEF 1 ømm for thermocouple		
	<b>Part No.</b>	100908	<b>Ref. No.</b> —
	union screw thread M10x1 for pipe ø 4mm Qty 1 pcs		
	<b>Part No.</b>	100909	<b>Ref. No.</b> —
	union screw thread M10x1 for pipe ø 6mm Qty 1 pcs		
	<b>Part No.</b>	102110	<b>Ref. No.</b> —
	pilot tube copper pipe ø 4mm thickness 1mm L 3000mm		
	<b>Part No.</b>	102111	<b>Ref. No.</b> —
	pilot tube copper pipe ø 6mm thickness 1mm L 3000mm		
	<b>Part No.</b>	102508	<b>Ref. No.</b> —
	union screw thread M10x1 for pipe ø 4mm Qty 5 pcs		
	<b>Part No.</b>	102509	<b>Ref. No.</b> —
	union screw thread M10x1 for pipe ø 6mm Qty 5 pcs		

<b>accessories for</b>	100162		
	<b>Part No.</b>	102699	<b>Ref. No.</b> —
	pilot burner nozzle POLIDORO natural gas code 25.2 bore ø 2x0.25mm Qty 1 pcs 2 bores		
	<b>Part No.</b>	102795	<b>Ref. No.</b> —
	olive for pipe ø 4mm Qty 1 pcs		
	<b>Part No.</b>	102797	<b>Ref. No.</b> —
	olive for pipe ø 6mm Qty 1 pcs		
	<b>Part No.</b>	106703	<b>Ref. No.</b> —
	pilot burner nozzle POLIDORO natural gas code 27.2 bore ø 2x0.27mm Qty 1 pcs		
	<b>Part No.</b>	106704	<b>Ref. No.</b> —
	pilot burner nozzle POLIDORO LPG code 16.2 bore ø 2x0.16mm Qty 1 pcs		
	<b>Part No.</b>	106763	<b>Ref. No.</b> —
	pilot burner nozzle POLIDORO natural gas code 27.2A bore ø 2x 0.27mm Qty 1 pcs		
	<b>Part No.</b>	106859	<b>Ref. No.</b> —
	pilot burner nozzle POLIDORO LPG code 24 bore ø 0.24mm Qty 1 pcs		

**accessories universal**

**pilot burner brackets**

1

	<b>Part No.</b>	105724	<b>Ref. No.</b>	35974400
<b>description</b>	pilot burner bracket			
<b>For models:</b>	G6F2BH9, G6F2BP9, G6F2MH9, G6F2MP9, G9F2M, G9F2MP, G9F4M, G9F4MP, G9F4P+FG, G9F4P+FG+AF2, G9F4P+FG1, G9F4P+FG1+AF1, G9F6M, G9F6MP, G9F6P+FG, G9F6P+FG1, G9F6P+T, G9F6P+T+AF2, G9F8P+2FG, G9F8P+2FG1, G9TP4FM, SG9F2M, SG9F2MP, SG9F4M, SG9F4MP, SG9F6M, SG9F6MP, SG9F6P+T			
<b>accessories for</b>	105724			
	<b>Part No.</b>	105097	<b>Ref. No.</b>	32327600
	nozzle holder nozzle mounting M10x1 tube ø 10mm gas inlet M16x1.5 gas outlet M14x1			
	<b>Part No.</b>	105725	<b>Ref. No.</b>	35807000
	burner head 9kW for burner cap ø 130mm			
	<b>Part No.</b>	105726	<b>Ref. No.</b>	35954300
	burner cap with central hole ø 130mm 9kW			



electrodes

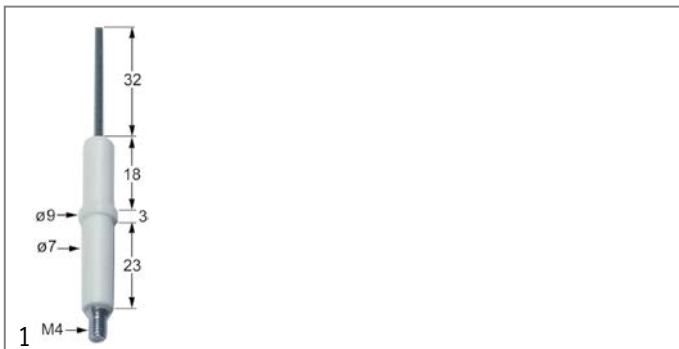

<b>Part No.</b>	100701	<b>Ref. No.</b>	22296900
<b>description</b>	ignition electrode connection M4 Qty 1 pcs		
<b>For models:</b>	6GL18B, 6GL18M, 9GL15+15M, 9GL15M, 9GL20+20M, 9GL20M, CPG40, CPG40E, CPG80, CPG80E, E9F15-4M, E9F15-8M, E9F18-4M, E9F18-8M, G4F+FSD8, G6CP6, G6F2B, G6F2B+A2, G6F4B, G6F4B+A4, G6F6B, G6F6B+A6, G6FL3B, G6FL3B-CR, G6FL3B-SX, G6FL3M, G6FL3M-CR, G6FL3M-SX, G6FL6B, G6FL6B-CR, G6FL6B-SX, G6FL6M, G6FL6M-CR, G6FL6M-SX, G6FM6B, G6FM6M, G6FR3B, G6FR3M, G6FR6B, G6FR6M, G6PL60B, G6PL60M, G7BM4M, G7FL4B, G7FL4BCR, G7FL4B-SX, G7FL4M, G7FL4M-CR, G7FL4M-SX, G7FL8B-2...(Other models you can see in the webshop)		
<b>accessories for</b>	100701		
	<b>Part No.</b>	100906	<b>Ref. No.</b> —
	screw connection thread M10x1 for ignition electrode brass Qty 1 pcs WS 10		

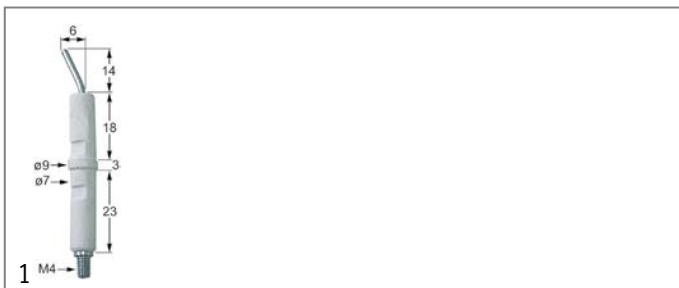

<b>Part No.</b>	100706	<b>Ref. No.</b>	22298332 23297400
<b>description</b>	ignition electrode connection M4 Qty 1 pcs		
<b>For models:</b>	FMG10, FMG10EP, FMG10M, FMG20, FMG20M, FMG6, FMG6EP, FMG6M, FPG12, FPG6, G9BR8, G9BR8-I, GL18+18MI, GL18+18MI-E, GL18MI, GL18MI-E, SG9BR8, SG9BR8-I, WAV2-GAS, WAV-G12, WAV-G20, WAV-G5U, WAV-G6		

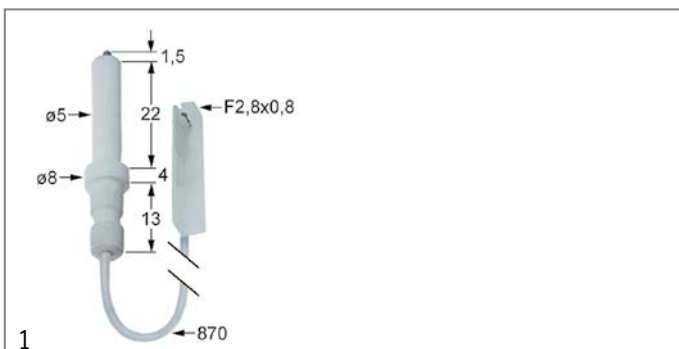

<b>Part No.</b>	102161	<b>Ref. No.</b>	35187800
<b>description</b>	ignition electrode D1 ø 5mm cable length 870mm connection F 2.8x0.8mm D2 ø 8mm L1 1.5mm BL1 22mm BL2 4mm BL3 13mm to clip		
<b>For models:</b>	G9F2ME, G9F2ME+A2, G9F4E+FE1+A4, G9F4E+FG1, G9F4E+FG1+A4, G9F4ME, G9F4ME+A4, G9F6E+FE1+A6, G9F6E+FG1, G9F6E+FG1+A6, G9F6ME, G9F6ME+A6		

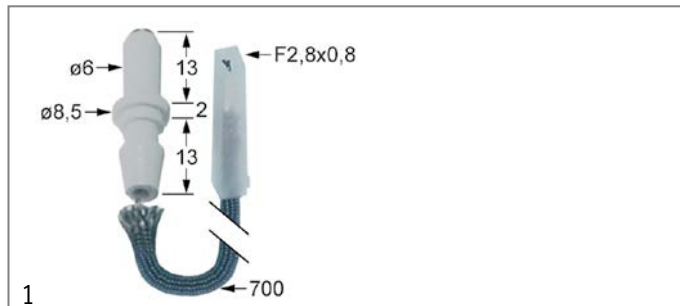

<b>Part No.</b>	100167	<b>Ref. No.</b>	31187800
<b>description</b>	ignition electrode D1 ø 6mm cable length 700mm connection F 2.8x0.8mm D2 ø 8.5mm BL1 14mm BL2 2mm BL3 13mm to clip		
<b>For models:</b>	G6F2B+A2, G6F2BPW+AE, G6F2M, G6F2M+A2, G6F2MPW+AE, G6F4+FE1+A4, G6F4+FG1+A4, G6F4B+A4, G6F4BPW+AE, G6F4M, G6F4M+A4, G6F4MPW+AE, G6F4PW+FE1+AE, G6F4PW+FG1+AE, G6F6+FE1+A6, G6F6+FG1+A6, G6F6+T+A6, G6F6+TE+A6, G6F6B+A6, G6F6BPW+AE, G6F6M, G6F6M+A6, G6F6MPW+AE, G6F6PW+FE1+AE, G6F6PW+FG1+AE, G6F6PW+T+AE, G6F6PW+TE+AE, G7F2BE+A2, G7F2BPW+AE, G7F2ME+A2, G7F2MPW+AE, G7F4BE+A4, G7F4BPW+AE, G7F4E+FE+A4, G7F4E+FE1+A4, G7F4E+FG+A4, G7F4E+FG1+A4, G7F4ME+A4, G7F4MPW+AE, G7F4PW+FE+AE, G7F4PW+FE1+AE, G7F4PW+FG+AE, G7F4PW+FG1+AE, G7F6BE+A6, G7F6BPW+AE, G7F6E+FE+A6, G7F6E+FE1+A6, G7F6E+FG+A4, G7F6E+FG+A6, G7F6E+FG1+A4...(Other models you can see in the webshop)		

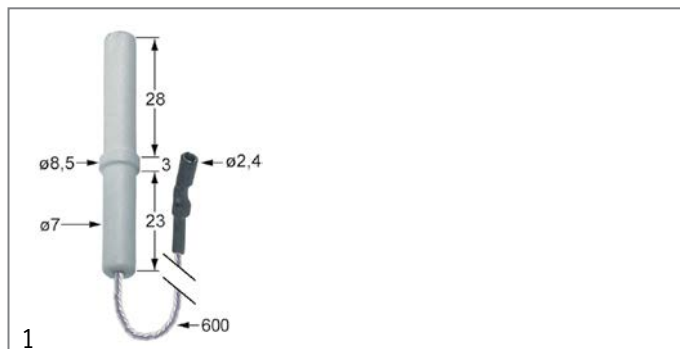

<b>Part No.</b>	100733	<b>Ref. No.</b>	22296200
<b>description</b>	ignition electrode D1 ø 7mm D2 ø 8.5mm cable length 600mm BL1 28mm BL2 3mm BL3 23mm to clip connection ø 2.4mm		
<b>For models:</b>	G2FS4-S, G4FD8-S, G4S+FCGN, G4S+FSGN, G6F12-S, G6S+FCGN, G6S+FSGN		



<b>Part No.</b>	100709	<b>Ref. No.</b>	35187600
<b>description</b>	ignition electrode D1 ø 7mm D2 ø 9mm connection M4 L1 13mm L2 13mm L3 23mm BL1 18mm BL2 3mm BL3 23mm to clip		
<b>For models:</b>	G9P10D, G9P10DA, G9P10I, G9P10IA, G9P15D, G9P15DA, G9P15I, G9P15IA, SG9P10D, SG9P10DA, SG9P10I, SG9P10IA, SG9P15D, SG9P15DA, SG9P15I		

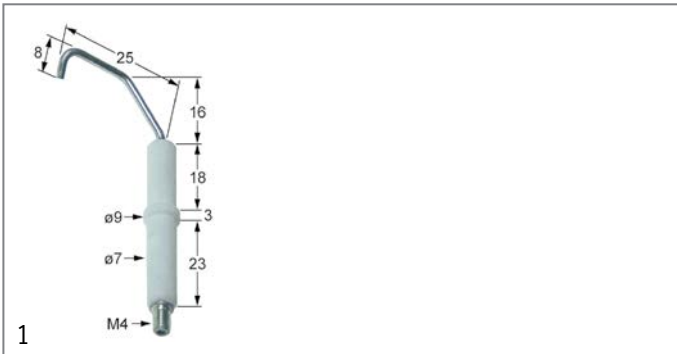

<b>Part No.</b>	100822	<b>Ref. No.</b>	31187000
<b>description</b>	ignition electrode D1 ø 7mm D2 ø 9mm connection M4 L1 16mm L2 25mm L3 8mm BL1 18mm BL2 3mm BL3 23mm to clip		
<b>For models:</b>	G12F4H9+FGP, G12F4P9+FGP, G6F6+T, G6F6+T+A6, G6F6PW+T+AE, G7F4+FG, G7F4E+FG, G7F4E+FG+A4, G7F4P+FG+AF2, G7F4PW+FG, G7F4PW+FG+AE, G7F6+FG, G7F6+T, G7F6E+FG, G7F6E+FG+A6, G7F6PW+FG, G7F6PW+FG+AE, G7F6PW+T, G7F6PW+T+AE, G7T4P4F+FG, G7TP+FG, G7TP2F+FG, G7TP2F+T, G9F4+FG, G9F4P+FG, G9F4P+FG+AF2, G9F4PW+FG, G9F4PW+FG+AE, G9F6+FG, G9F6+T, G9F6P+FG, G9F6P+T, G9F6P+T+AF2, G9F6PW+FG, G9F6PW+FG+AE, G9F6PW+T, G9F6PW+T+AE, G9F8+2FG, G9F8P+2FG, G9TP+FG, G9TP2F+FG, G9TP2F+T, G9TP4F+FG, SG9F4+FG, SG9F4P+FG...(Other models you can see in the webshop)		

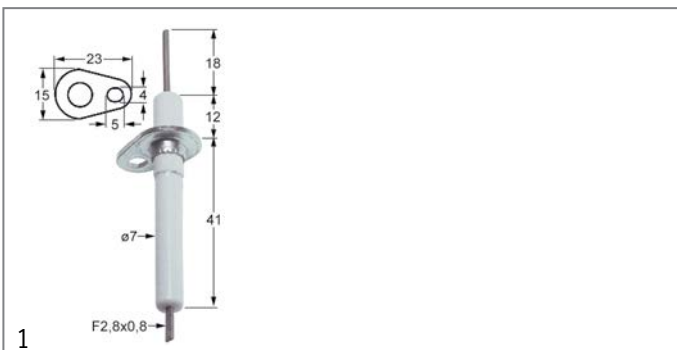

<b>Part No.</b>	100818	<b>Ref. No.</b>	22296500
<b>description</b>	ignition electrode flange length 23mm flange width 15mm D1 ø 7mm L1 18mm BL1 12mm BL2 41mm connection F 2.8x0.8mm fixing dimensions ø5x4mm with flange		
<b>For models:</b>	G4F+FSD8, G4S+FSGN, G6F4PW+FG1+AE, G6F6PW+FG1+AE, G6S+FSGN, G7F4P+FG1+AF1, G7F4PW+FG1, G7F4PW+FG1+AE, G7F-6P+FG1+AF1, G7F6PW+FG1, G7F6PW+FG1+AE, G9F4P+FG1+AF1, G9F4PW+FG1, G9F4PW+FG1+AE, G9F6PW+FG1, G9F6PW+FG1+AE, G9F8P+2FG1		

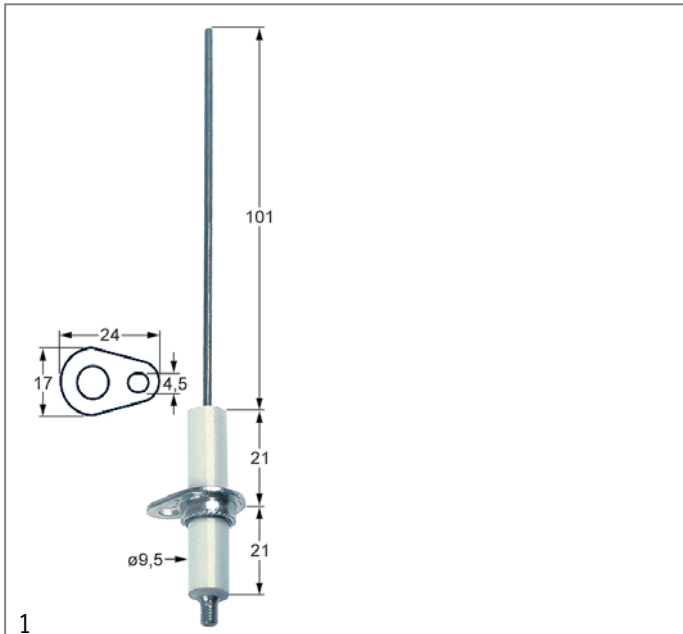

<b>Part No.</b>	102323	<b>Ref. No.</b>	31187600
<b>description</b>	ignition electrode flange length 24mm flange width 17mm D1 ø 9.5mm L1 101mm BL2 21mm BL3 21mm connection M4 fixing dimensions ø4.5mm with flange		
<b>For models:</b>	G7PI		

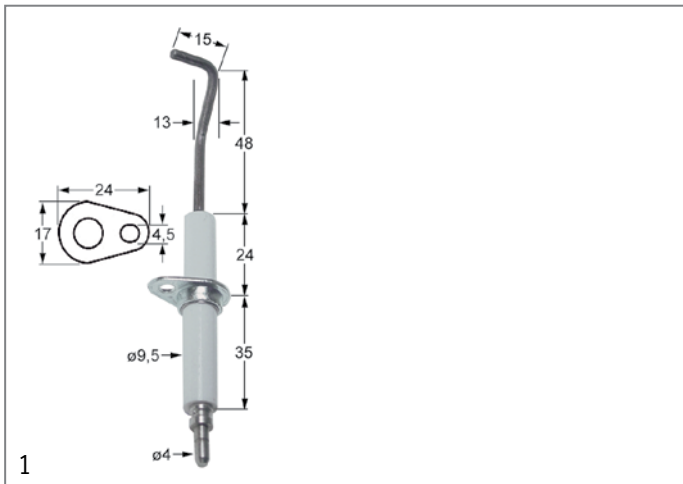

<b>Part No.</b>	102342	<b>Ref. No.</b>	25297600
<b>description</b>	ignition electrode flange length 24mm flange width 17mm D1 ø 9.5mm L1 48mm L2 13mm L3 15mm BL1 24mm BL2 35mm fixing dimensions ø4.5mm with flange connection ø 4mm		
<b>For models:</b>	FC100GEP, FC100GM, FC200GA, FC200GB, FC60GEP, FC60GM, FMG10, FMG10M, FMG6, FMG6M, MM06GA, MM06GB, MM10GA, MM10GB		

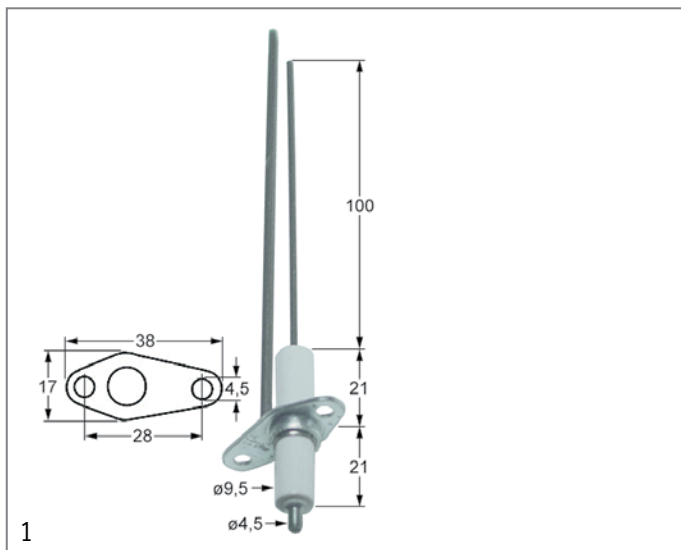

<b>Part No.</b>	102322	<b>Ref. No.</b>	31187400
<b>description</b>	ignition electrode flange length 38mm flange width 17mm D1 ø 9.5mm L1 100mm BL1 21mm BL2 21mm connection M4 fixing dimensions ø4.5mm mounting distance 28mm with flange with earthing contact		
<b>For models:</b>	G7PI		

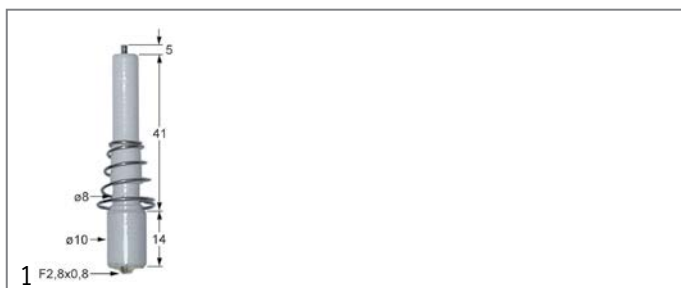

<b>Part No.</b>	100729	<b>Ref. No.</b>	22296100
<b>description</b>	ignition electrode L1 5mm D1 ø 8mm D2 ø 10mm BL1 41mm BL2 14mm connection F 2.8x0.8mm to clip with spring		
<b>For models:</b>	G2FS4, G4F+FCD8, G4F+FSD8, G4FD8		

ignition cables

pre-assembled cables

<b>Part No.</b>	102192	<b>Ref. No.</b>	22189400
<b>description</b>	ignition cable cable length 1750mm connection F2.8mm / F2.8mm		
<b>For models:</b>	G4F+FSD8, G4S+FSGN, G6S+FSGN, G7F4P+FG1+AF1, G7F4PW+FG1, G7F4PW+FG1+AE, G7F6P+FG1+AF1, G7F6PW+FG1, G7F6PW+FG1+AE, G9F4P+FG1+AF1, G9F8P+2FG1		

<b>Part No.</b>	100137	<b>Ref. No.</b>	31189900
<b>description</b>	ignition cable cable length 2000mm connection ø2.4mm / ø4mm		
<b>For models:</b>	G12F4H9+FGP, G12F4P9+FGP, G6F6+T, G6F6+T+A6, G7F4+FG, G7F4E+FG, G7F4E+FG+A4, G7F4P+FG, G7F4P+FG+AF2, G7F4PW+FG, G7F4PW+FG+AE, G7F6+FG, G7F6+T, G7F6E+FG, G7F6E+FG+A6, G7F6E+T, G7F6P+FG, G7F6P+FG+AF2, G7F6P+T, G7F6P+T+AF2, G7F6PW+FG, G7F6PW+FG+AE, G7F6PW+T, G7F6PW+T+AE, G7PD, G7T4P4F+FG, G7TP+FG, G7TP2F+FG, G7TP2F+T, G9F4+FG, G9F4P+FG, G9F4P+FG+AF2, G9F6+FG, G9F6+T, G9F6P+FG, G9F6P+T, G9F6P+T+AF2, G9F8+2FG, G9F8P+2FG, G9TP+FG, G9TP2F+FG, G9TP2F+T, G9TP4F+FG, SG9F4+FG, SG9F4P+FG, SG9F6+FG, SG9F6+T, SG9F6P+FG, SG9F6P+T, SG9F8+2FG...(Other models you can see in the webshop)		

<b>Part No.</b>	102162	<b>Ref. No.</b>	31189700
<b>description</b>	ignition cable cable length 400mm connection F2.8mm / F6.3mm		
<b>For models:</b>	G6F2B+A2, G6F2M+A2, G6F4+FE1+A4, G6F4+FG1+A4, G6F4B+A4, G6F4M+A4, G6F6+FE1+A6, G6F6+FG1+A6, G6F6+T+A6, G6F6+TE+A6, G6F6B+A6, G6F6M+A6, G7F2BE+A2, G7F2ME+A2, G7F4BE+A4, G7F4E+FE+A4, G7F4E+FE1+A4, G7F4E+FG+A4, G7F4E+FG1+A4, G7F4ME+A4, G7F4P+FG+AF2, G7F4P+FG1+AF1, G7F6BE+A6, G7F6E+FE+A6, G7F6E+FE1+A6, G7F6E+FG+A4, G7F6E+FG+A6, G7F6E+FG1+A4, G7F6E+FG1+A6, G7F6E+T, G7F6ME+A6, G7F6P+FG+AF2, G7F6P+FG1+AF1, G7F6P+T+AF2, G9F2ME, G9F2ME+A2, G9F4E+FE1+A4, G9F4E+FG1, G9F4E+FG1+A4, G9F4ME, G9F4ME+A4, G9F4P+FG+AF2, G9F4P+FG1+AF1, G9F6E+FE1+A6, G9F6E+FG1, G9F6E+FG1+A6, G9F6ME, G9F6ME+A6, G9F6P+T+AF2, G9F8P+2FG1		

<b>Part No.</b>	100186	<b>Ref. No.</b>	22189100 22189200
<b>description</b>	ignition cable cable length 600mm connection ø2.4mm / lug M4		
<b>For models:</b>	6GL18B, 6GL18M, 9GL15+15M, 9GL15M, 9GL20+20M, 9GL20M, CPG40, CPG40E, CPG80, CPG80E, E9F15-4M, E9F15-8M, E9F18-4M, E9F18-8M, G6CP6, G6FL3B, G6FL3B-CR, G6FL3B-SX, G6FL3M, G6FL3M-CR, G6FL3M-SX, G6FL6B, G6FL6B-CR, G6FL6B-SX, G6FL6M, G6FL6M-CR, G6FL6M-SX, G6FM6B, G6FM6M, G6FR3B, G6FR3M, G6FR6B, G6FR6M, G6PL60B, G6PL60M, G7FL4B, G7FL4B-CR, G7FL4BSX, G7FL4M, G7FL4M-CR, G7FL4M-SX, G7FL8B-2, G7FL8B-2-CR, G7FL8B-2-SX, G7FL8M-2, G7FL8M-2-CR, G7FL8M-2-SX, G7FM8B-2, G7FM8M-2, G7FR4B...(Other models you can see in the webshop)		

<b>Part No.</b>	100015	<b>Ref. No.</b>	32189300
<b>description</b>	ignition cable cable length 600mm connection ø2.4mm / ø2.4mm		
<b>For models:</b>	G7TP+FG1, G7TPM, G9TP+FG1, G9TPM, SG9TPM		

<b>Part No.</b>	100018	<b>Ref. No.</b>	22189100
<b>description</b>	ignition cable cable length 600mm connection ø2.4mm / ø4mm permanent temperature 200°C		

piezoelectric igniters

mounting diameter 18mm

<b>Part No.</b>	100009	<b>Ref. No.</b>	31001000 32188200
<b>description</b>	piezoelectric igniter body plastic blowing mounting ø 18mm connection ø2.4mm front measurements 26mm M18x1.5		
<b>accessories for</b>	100009		
<b>Part No.</b>	101339	<b>Ref. No.</b>	—
<b>description</b>	cover cap for piezoelectric igniter		
<b>Part No.</b>	106869	<b>Ref. No.</b>	—
<b>description</b>	cover cap for piezoelectric igniter ID ø 22mm ED ø 35mm H 25mm		

Table continues overleaf



accessories for	100009		
	<b>Part No.</b>	107931	<b>Ref. No.</b> 32188400
	cover cap for piezoelectric igniter ID ø 21mm ED ø 36mm		

	1		
<b>Part No.</b>	103361	<b>Ref. No.</b>	32188300
<b>description</b>	piezoelectric igniter body plastic blowing mounting ø 18mm connection ø2.4mm front measurements 26mm M18x1.5		

mounting diameter 22mm

	1		
<b>Part No.</b>	100005	<b>Ref. No.</b>	22188300
<b>description</b>	piezoelectric igniter body plastic blowing mounting ø 22mm connection ø2.4mm cable lengthmm SIT		
<b>For models:</b>	G2FS4, G2FS4-S, G4F+FG, G4F+FGD8, G4FD8, G4FD8-S, G4S+FCGN, G4S+FCGN, G6F12-S, G6S+FCGN, G6S+FCGN, G9BR8, G9BR8-I, G9P10D, G9P10DA, G9P10I, G9P10IA, G9P15D, G9P15DA, G9P15I, G9P15IA, GFLD8, GFLD8-CR, GFLM6, GFLM6-CR, GFLS4, GFLS4-CR, GFRD8, GFRM6, GFRS4, SG9BR8, SG9BR8-I, SG9P10D, SG9P10DA, SG9P10I, SG9P10IA, SG9P15D, SG9P15DA, SG9P15I		

accessories

	1		
<b>Part No.</b>	107931	<b>Ref. No.</b>	32188400
<b>description</b>	cover cap for piezoelectric igniter ID ø 21mm ED ø 36mm		
<b>For models:</b>	G12F4H9+FGP, G12F4P9+FGP, G6F6+T, G6F6+T+A6, G7F4+FG, G7F4E+FG, G7F4E+FG+A4, G7F4P+FG, G7F4PW+FG, G7F4PW+FG1, G7F6+FG, G7F6+T, G7F6E+FG, G7F6E+FG+A6, G7F6E+T, G7F6P+FG, G7F6P+T, G7F6PW+FG, G7F6PW+FG1, G7F6PW+T, G7T4P4F+FG, G7TP+FG, G7TP2F+FG, G7TP2F+T, G9BM4M, G9BR8-I, G9F4+FG, G9F4P+FG, G9F4PW+FG, G9F4PW+FG1, G9F6+FG, G9F6+T, G9F6P+FG, G9F6P+T, G9F6PW+FG, G9F6PW+FG1, G9F6PW+T, G9F8+2FG, G9F8P+2FG, G9P10D, G9P10DA, G9P10I, G9P10IA, G9P15D, G9P15DA, G9P15I, G9P15IA, G9P20D, G9P20DA, G9TP+FG...(Other models you can see in the webshop)		

ignition units

	1		
<b>Part No.</b>	101030	<b>Ref. No.</b>	31003000
<b>description</b>	ignition unit outputs 2 1.5 V/DC		
<b>For models:</b>	G6F4PW+FG1+AE, G6F6BPW+AE, G6F6MPW+AE, G6F6PW+FE1+AE, G6F6PW+FG1+AE, G6F6PW+T+AE, G6F6PW+TE+AE, G7F4PW+FG+AE, G7F4PW+FG1+AE, G7F6BPW+AE, G7F6MPW+AE, G7F6PW+-FE+AE, G7F6PW+FE1+AE, G7F6PW+FG+AE, G7F6PW+FG1+AE, G7F6PW+T+AE, G9F4PW+FG+AE, G9F4PW+FG1+AE, G9F6MPW+AE, G9F6PW+FE+AE, G9F6PW+FG+AE, G9F6PW+FG1+AE, G9F6PW+T+AE		

	1		
<b>Part No.</b>	102485	<b>Ref. No.</b>	32164200
<b>description</b>	ignition unit outputs 2 220-240VAC 0.6VA 50-60Hz		
<b>For models:</b>	FMG10, FMG10EP, FMG10M, FMG20, FMG20M, FMG6, FMG6EP, FMG6M, FPG12, FPG6, GL10+10B8, GL10+10M8, GL10B4, GL10M4, GL15+15M8, GL15M4, GL20+20M8, GL20M4, WAV-G12, WAV-G20, WAV-G5U, WAV-G6		

	1		
<b>Part No.</b>	101002	<b>Ref. No.</b>	22164232
<b>description</b>	ignition unit outputs 2 230VAC dimensions 88x23x34mm mounting distance 73mm inlet F6.3x0.8 outlet F2.8x0.8 0.6VA 50/60Hz		

	1		
<b>Part No.</b>	101031	<b>Ref. No.</b>	31002200
<b>description</b>	ignition unit outputs 4 1.5 V/DC dimensions 111x23x34mm mounting distance 100mm inlet F6.3x0.8 outlet F2.8x0.8 mounting ø 100mm		
<b>For models:</b>	G6F4+FE1+A4, G6F4+FG1+A4, G6F4B+A4, G6F4M+A4, G7F4BE+A4, G7F4E+FE+A4, G7F4E+FE1+A4, G7F4E+FG+A4, G7F4E+FG1+A4, G7F4ME+A4, G9F4E+FE1+A4, G9F4E+FG1+A4, G9F4ME, G9F4ME+A4		

	1		
<b>Part No.</b>	101032	<b>Ref. No.</b>	31002400
<b>description</b>	ignition unit outputs 6 1.5 V/DC dimensions 135x23x34mm mounting distance 123mm inlet F6.3x0.8 outlet F2.8x0.8 mounting ø 122mm		
<b>For models:</b>	G6F6+FE1+A6, G6F6+FG1+A6, G6F6+T+A6, G6F6+TE+A6, G6F6B+A6, G6F6M+A6, G7F6BE+A6, G7F6E+FE+A6, G7F6E+FE1+A6, G7F6E+FG+A4, G7F6E+FG+A6, G7F6E+FG1+A4, G7F6E+FG1+A6, G7F6E+T, G7F6ME+A6, G9F4E+FE1+A4, G9F4E+FG1+A4, G9F6E+FE1+A6, G9F6E+FG1+A6, G9F6ME, G9F6ME+A6		

ignition switches

	1		
<b>Part No.</b>	106646	<b>Ref. No.</b>	31877300
<b>description</b>	ignition switch double		
<b>For models:</b>	G6F2B+A2, G6F2BPW+AE, G6F2M+A2, G6F2MPW+AE, G7F2BE+A2, G7F2BPW+AE, G7F2ME+A2, G7F2MPW+AE, G9F2ME, G9F2ME+A2, G9F2MPW+AE		





			
1			
<b>Part No.</b>	101033	<b>Ref. No.</b>	31877400
<b>description</b>	ignition switch double for gas taps Sabaf		
<b>For models:</b>	G7F2BE+A2, G7F2ME+A2, G9F2ME, G9F2ME+A2		

			
1			
<b>Part No.</b>	101039	<b>Ref. No.</b>	31877600
<b>description</b>	ignition switch 4-fold		
<b>For models:</b>	G6F4+FE1+A4, G6F4+FG1+A4, G6F4B+A4, G6F4BPW+AE, G6F4M+A4, G6F4MPW+AE, G6F4PW+FE1+AE, G6F4PW+FG1+AE, G6F6+FG1+A6, G7F4BE+A4, G7F4BPW+AE, G7F4E+FE+A4, G7F4E+FE1+A4, G7F4E+FG+A4, G7F4E+FG1, G7F4E+FG1+A4, G7F4MPW+AE, G7F4PW+FE+AE, G7F4PW+FE1+AE, G7F4PW+FG+AE, G7F4PW+FG1+AE, G7F6E+FE1+A6, G9F4E+FE1+A4, G9F4E+FG1+A4, G9F4ME, G9F4ME+A4, G9F4MPW+AE, G9F4PW+FE+AE, G9F4PW+FE1+AE, G9F4PW+FG+AE, G9F4PW+FG1+AE		

			
1			
<b>Part No.</b>	101034	<b>Ref. No.</b>	31877500
<b>description</b>	ignition switch 4-fold for gas taps Sabaf		
<b>For models:</b>	G7F4BE+A4, G7F4E+FE+A4, G7F4E+FE1, G7F4E+FE1+A4, G7F4E+FG+A4, G7F4E+FG1, G7F4E+FG1+A4, G7F4ME+A4, G9F4E+FE1+A4, G9F4E+FG1+A4, G9F4ME, G9F4ME+A4		

			
1			
<b>Part No.</b>	101035	<b>Ref. No.</b>	31877700 31877800
<b>description</b>	ignition switch 6-fold for gas taps Sabaf		
<b>For models:</b>	G6F4+FG1+A4, G6F6+FE1+A6, G6F6+T+A6, G6F6+TE+A6, G6F6B+A6, G6F6BPW+AE, G6F6M+A6, G6F6MPW+AE, G6F6PW+FE1+AE, G6F6PW+FG1+AE, G6F6PW+T+AE, G6F6PW+TE+AE, G7F4E+FE1+A4, G7F6BE+A6, G7F6BPW+AE, G7F6E+FE+A6, G7F6E+FE1+A6, G7F6E+FG+A4, G7F6E+FG+A6, G7F6E+FG1, G7F6E+FG1+A4, G7F6E+FG1+A6, G7F6E+T, G7F6MPW+AE, G7F6PW+FE+AE, G7F6PW+FE1+AE, G7F6PW+FG+AE, G7F6PW+FG1+AE, G7F6PW+T+AE, G9F6E+FE1+A6, G9F6E+FG1+A6, G9F6ME, G9F6ME+A6, G9F6MPW+AE, G9F6PW+FE+AE, G9F6PW+FG+AE, G9F6PW+FG1+AE, G9F6PW+T+AE		

			
1			
<b>Part No.</b>	101036	<b>Ref. No.</b>	31915000
<b>description</b>	battery holder for battery type AA 1.5V mounting ø 22mm connection male faston 2.8mm/6.3mm		
<b>For models:</b>	G6F2B+A2, G6F2M+A2, G6F4+FE1+A4, G6F4+FG1+A4, G6F-4B+A4, G6F4M+A4, G6F6+FE1+A6, G6F6+FG1+A6, G6F6+T+A6, G6F6+TE+A6, G6F6B+A6, G6F6M+A6, G7F2BE+A2, G7F2ME+A2, G7F-4BE+A4, G7F4E+FE+A4, G7F4E+FE1, G7F4E+FE1+A4, G7F4E+FG+A4, G7F4E+FG1+A4, G7F4ME+A4, G7F4P+FG+AF2, G7F4P+FG1+AF1, G7F6BE+A6, G7F6E+FE+A6, G7F6E+FE1, G7F6E+FE1+A6, G7F6E+FG+A4, G7F6E+FG+A6, G7F6E+FG1+A4, G7F6E+FG1+A6, G7F6E+T, G7F6ME+A6, G7F6P+FG+AF2, G7F6P+FG1+AF1, G7F6P+T+AF2, G9F2ME, G9F2ME+A2, G9F4E+FE1+A4, G9F4E+FG1+A4, G9F4ME, G9F4ME+A4, G9F4P+FG+AF2, G9F4P+FG1+AF1, G9F6E+FE1+A6, G9F6E+FG1+A6, G9F6ME, G9F6ME+A6, G9F6P+T, G9F6P+T+AF2... (Other models you can see in the webshop)		

			
1			
<b>Part No.</b>	101445	<b>Ref. No.</b>	31938400
<b>description</b>	disc for ignition switch ID ø 8.8mm ED ø 12.5mm		
<b>For models:</b>	G7F2BE+A2, G7F2ME+A2, G7F4BE+A4, G7F4E+FE+A4, G7F4E+FE1+A4, G7F4E+FG+A4, G7F4E+FG1+A4, G7F4ME+A4, G7F6BE+A6, G7F6E+FE+A6, G7F6E+FE1+A6, G7F6E+FG+A4, G7F6E+FG1+A4, G7F6E+FG1+A6, G7F6E+T, G7F6ME+A6, G9F2ME, G9F2ME+A2, G9F4E+FE1+A4, G9F4E+FG1+A4, G9F4ME, G9F4ME+A4, G9F6ME, G9F6ME+A6		

## thermocouples

### plug-in thermocouples

### plug-in thermocouples standard

with barrel socket ø6(6.5)mm

### thermocouples SIT

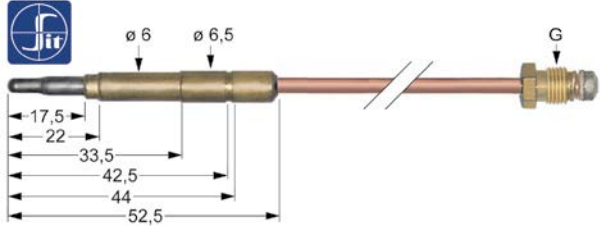
			
1			
<b>Part No.</b>	107619	<b>Ref. No.</b>	31288000
<b>description</b>	thermocouple SIT M10x1 L 1000mm plug connection ø6.0(6.5)mm		



<b>Part No.</b>	107621	<b>Ref. No.</b>	31288000
<b>description</b>	thermocouple SIT M10x1 L 1500mm plug connection ø6.0(6.5)mm		
<b>For models:</b>	G7PD		

<b>Part No.</b>	107609	<b>Ref. No.</b>	22289200
<b>description</b>	thermocouple SIT M9x1 L 600mm plug connection ø6.0(6.5)mm		
<b>For models:</b>	CPG40, CPG40E, CPG80, CPG80E, E9F15-4M, E9F15-8M, E9F18-4M, E9F18-8M, G12F4H9+FGP, G12F4H9M, G12F4P9+FGP, G12F4P9M, G2FS4-S, G4FD8-S, G4S+FCGN, G4S+FSGN, G6CP6, G6F12-S, G6F2B, G6F2B+A2, G6F2BH6, G6F2BH9, G6F2BP6, G6F2BP9, G6F2H6+FE1, G6F2H6+FG1, G6F2H9+FE1, G6F2H9+FG1, G6F2H9+T, G6F2H9+TE, G6F2MH6, G6F2MH9, G6F2MP6, G6F2MP9, G6F2P6+FE1, G6F2P6+FG1, G6F2P9+FE1, G6F2P9+FG1, G6F2P9+T, G6F2P9+TE, G6F3BH12, G6F3BH9, G6F3H12+FE1, G6F3H12+FG1, G6F3H12+T, G6F3H12+TE, G6F3H9+T, G6F3MH12, G6F4B, G6F4B+A4...(Other models you can see in the webshop)		

<b>Part No.</b>	107612	<b>Ref. No.</b>	23288900
<b>description</b>	thermocouple SIT M9x1 L 1000mm plug connection ø6.0(6.5)mm		
<b>For models:</b>	FMG10M, FMG6M, FPG12, FPG6, WAV-G12, WAV-G20, WAV-G5U, WAV-G6		

<b>Part No.</b>	107614	<b>Ref. No.</b>	31289000
<b>description</b>	thermocouple SIT M9x1 L 1500mm plug connection ø6.0(6.5)mm		
<b>For models:</b>	G12F4H9+FGP, G12F4P9+FGP, G6F2B, G6F2B+A2, G6F2H9+T, G6F2P9+T, G6F3H12+T, G6F3H9+T, G6F4B, G6F4B+A4, G6F6+T, G6F6+T+A6, G6F6B, G6F6B+A6, G6F6PW+T, G6F6PW+T+AE, G7F4+FG, G7F4E+FG, G7F4E+FG+A4, G7F4P+FG, G7F4P+FG+AF2, G7F4PW+FG, G7F4PW+FG+AE, G7F6+FG, G7F6E+FG, G7F6E+FG+A4, G7F6E+FG+A6, G7F6E+T, G7F6P+FG, G7F6P+FG+AF2, G7F6P+T, G7F6P+T+AF2, G7F6PW+FG, G7F6PW+FG+AE, G7F6PW+T, G7F6PW+T+AE, G7T4P4F+FG, G7TP+FG, G7TP2F+FG, G7TP2F+T, G9F4+FG, G9F4P+FG, G9F4P+FG+AF2, G9F4PW+FG, G9F4PW+FG+AE, G9F6+FG, G9F6P+FG, G9F6P+FG+AF2, G9F6P+T, G9F6P+T+AF2...(Other models you can see in the webshop)		

<b>Part No.</b>	107608	<b>Ref. No.</b>	31288600
<b>description</b>	thermocouple SIT M9x1 L 500mm plug connection ø6.0(6.5)mm		
<b>For models:</b>	G6FL3B, G6FL3B-CR, G6FL3B-SX, G6FL3M, G6FL3M-CR, G6FL3M-SX, G6FL6B, G6FL6B-CR, G6FL6B-SX, G6FL6M, G6FL6M-CR, G6FL6M-SX, G6FM6B, G6FM6M, G6FR3B, G6FR3M, G6FR6B, G6FR6M, G7FL4B, G7FL4B-CR, G7FL4B-SX, G7FL4M, G7FL4M-CR, G7FL4M-SX, G7FL8B-2, G7FL8B-2-CR, G7FL8B-2-SX, G7FL8M-2, G7FL8M-2-CR, G7FL8M-2-SX, G7FM8B-2, G7FM8M-2, G7FR4B, G7FR4M, G7FR8B-2, G7FR8M, G7FR8M-2, G9BR8, G9BR8-I, G9FL4M, G9FL4M-CPD, G9FL4M-CR, G9FL4M-SX, G9FL8M-2, G9FL8M-2-CPD, G9FL8M-2-CR, G9FL8M-2-SX, G9FM8M-2, G9FR4M, G9FR8M-2...(Other models you can see in the webshop)		

plug-in thermocouples with interruption

<b>Part No.</b>	107932	<b>Ref. No.</b>	31290100
<b>description</b>	thermocouple SIT with interrupter M9x1 L 1500mm plug connection ø6.0(6.5)mm cable 500mm		

<b>Part No.</b>	102247	<b>Ref. No.</b>	32290100
<b>description</b>	thermocouple with interrupter M9x1 L 600mm plug connection ø6.0mm cable 700mm		
<b>For models:</b>	6GL18B, 6GL18M, 9GL15+15M, 9GL15M, 9GL20+20M, 9GL20M, GL10+10B, GL10+10M, GL10B, GL10M, GL15+15M, GL15M, GL18+18MI, GL18+18MI-E, GL18MI, GL18MI-E, GL20+20M, GL20M, GL30B, GL30M, GL7+7M, GL8+8B, GL8+8M, GL8B, GL8M, S9GL20+20M, S9GL20M, S9GL22M		



threaded thermocouples

threaded thermocouples standard

with socket with thread M8x1

SIT

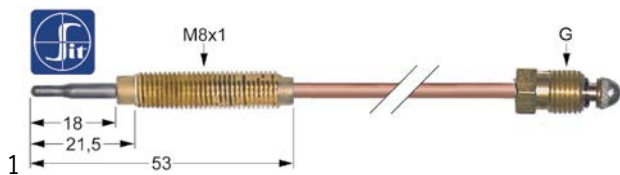

**Part No.** 107634 **Ref. No.** 22287400

**description** thermocouple SIT M8x1 L 1500mm M8x1

**accessories for** 107634



**Part No.** 102067 **Ref. No.** 22290900

nut thread M8x1 H 3mm brass Qty 1 pcs type SEF 1

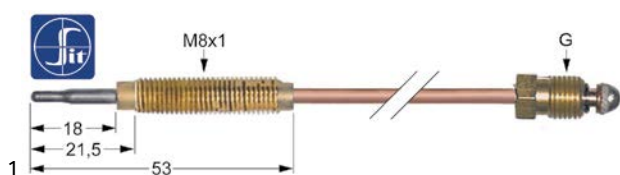

**Part No.** 107636 **Ref. No.** 22286900

**description** thermocouple SIT M9x1 L 600mm M8x1

**For models:** G2FS4, G4F+FCD8, G4FD8

**accessories for** 107636



**Part No.** 102067 **Ref. No.** 22290900

nut thread M8x1 H 3mm brass Qty 1 pcs type SEF 1

type Junkers with aluminised tip

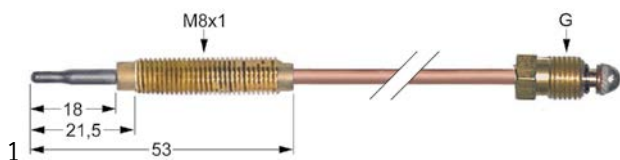

**Part No.** 102059 **Ref. No.** 22287500

**description** thermocouple M8x1 L 1200mm M8x1

**For models:** G6F2H6+FG1, G6F2H9+FG1, G6F2P6+FG1, G6F2P9+FG1, G6F-3H12+FG1, G6F4+FG1, G6F4+FG1+A4, G6F4PW+FG1, G6F4PW+FG1+AE, G6F6+FG1, G6F6+FG1+A6, G6F6PW+FG1, G6F6PW+FG1+AE, G7F4+FG1, G7F4E+FG1, G7F4E+FG1+A4, G7F4P+FG1, G7F4P+F G1+AF1, G7F4PW+FG1, G7F4PW+FG1+AE, G7F6+FG1, G7F6E+FG1, G7F6E+FG1+A4, G7F6E+FG1+A6, G7F6P+FG1, G7F6P+FG1+AF1, G7F6PW+FG1, G7F6PW+FG1+AE, G7T4P2F+FG1, G7T4P4F+FG1, G9F4+FG1, G9F4E+FG1, G9F4E+FG1+A4, G9F4P+FG1, G9F4P+F G1+AF1, G9F4PW+FG1, G9F4PW+FG1+AE, G9F6+FG1, G9F6E+FG1, G9F6E+FG1+A4, G9F6P+FG1, G9F6PW+FG1, G9F6PW+FG1+AE, G9F8+2FG1, G9F8P+2FG1, G9TP2F+FG1

**accessories for** 102059



**Part No.** 102067 **Ref. No.** 22290900

nut thread M8x1 H 3mm brass Qty 1 pcs type SEF 1

threaded thermocouples (miscellaneous)

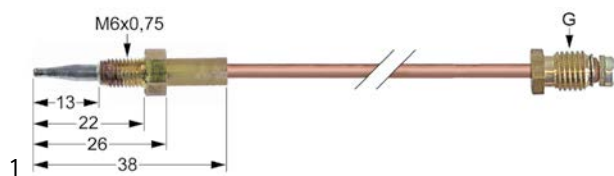

**Part No.** 107185 **Ref. No.** 31288300

**description** thermocouple M9x1 L 600mm M6x0.75

**accessories for** 107185



**Part No.** 103173 **Ref. No.** —

nut thread M6x0.75 H 4mm WS 10 brass Qty 1 pcs

threaded thermocouples with cable link

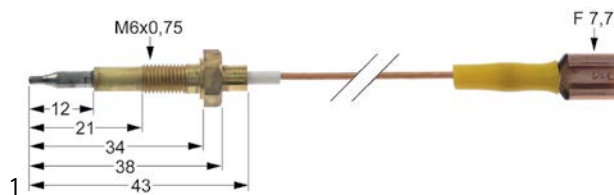

**Part No.** 102242 **Ref. No.** 35289200

**description** thermocouple with cable link L 750mm connection F 7.7mm M6x0.75

**For models:** G9F2ME, G9F2ME+A2, G9F4E+FE1, G9F4E+FE1+A4, G9F4E+FG1, G9F4E+FG1+A4, G9F4ME, G9F4ME+A4, G9F6E+FE1, G9F6E+FE1+A6, G9F6E+FG1, G9F6E+FG1+A6, G9F6ME, G9F6ME+A6

**accessories for** 102242



**Part No.** 102680 **Ref. No.** 31807600

nut thread M6x0.75 H 2.6mm WS 8 brass Qty 1 pcs type SEF 2

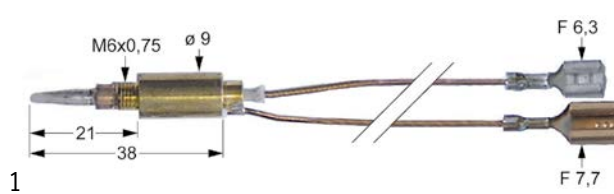

**Part No.** 102120 **Ref. No.** 31289200

**description** thermocouple with two-conductors L 750mm M6x0.75 F 7.7mm F 6.3mm

**For models:** G6F2B, G6F2B+A2, G6F2BPW+AE, G6F2M, G6F2M+A2, G6F2MPW+AE, G6F4+FE1, G6F4+FE1+A4, G6F4+FG1, G6F4+FG1+A4, G6F4B, G6F-4B+A4, G6F4BPW+AE, G6F4M, G6F4M+A4, G6F4MPW+AE, G6F4PW+FE1+AE, G6F4PW+FG1+AE, G6F6+FE1, G6F6+FE1+A6, G6F6+FG1, G6F6+FG1+A6, G6F6+T, G6F6+T+A6, G6F6+TE, G6F6+TE+A6, G6F6B, G6F6B+A6, G6F6BPW+AE, G6F6M, G6F6M+A6, G6F6MPW+AE, G6F6PW+FE1+AE, G6F6PW+FG1+AE, G7F2BE, G7F2BE+A2, G7F2BPW+AE, G7F2BPW-F, G7F2ME, G7F2ME+A2, G7F4BE, G7F4BE+A4, G7F4BPW+AE, G7F4E+FE, G7F4E+FE+A4, G7F4E+FE1, G7F4E+FE1+A4, G7F4E+FG, G7F4E+FG+A4, G7F4E+FG1... (Other models you can see in the webshop)

**accessories for** 102120



**Part No.** 102680 **Ref. No.** 31807600

nut thread M6x0.75 H 2.6mm WS 8 brass Qty 1 pcs type SEF 2











accessories

nuts

	1		
<b>Part No.</b>	102067	<b>Ref. No.</b>	22290900
<b>description</b>	nut thread M8x1 H 3mm brass Qty 1 pcs type SEF 1		
<b>For models:</b>	G2FS4, G4F+FCD8, G4F+FSD8, G4FD8, G6F2H6+FG1, G6F2P6+FG1, G6F4+FG1, G6F4+FG1+A4, G6F4PW+FG1, G6F4PW+FG1+AE, G6F6+FG1, G6F6+FG1+A6, G6F6PW+FG1, G6F6PW+FG1+AE, G7F4+FG1, G7F4E+FG1, G7F4E+FG1+A4, G7F4P+FG1, G7F4P+FG1+AF1, G7F4PW+FG1, G7F4PW+FG1+AE, G7F6+FG1, G7F6E+FG1, G7F6E+FG1+A4, G7F6E+FG1+A6, G7F6P+FG1, G7F6P+FG1+AF1, G7F6PW+FG1, G7F6PW+FG1+AE, G7T4P2F+FG1, G7T4P4F+FG1, G7TP+FG1, G7TP2F+FG1, G9F4+FG1, G9F4E+FG1, G9F4E+FG1+A4, G9F4P+FG1, G9F4P+FG1+AF1, G9F4PW+FG1, G9F4PW+FG1+AE, G9F6+FG1, G9F6E+FG1, G9F6E+FG1+A6, G9F6P+FG1, G9F6PW+FG1, G9F6PW+FG1+AE, G9F8+2FG1, G9F8P+2FG1, G9TP+FG1, G9TP2F+FG1		

	1		
<b>Part No.</b>	104102	<b>Ref. No.</b>	22283200
<b>description</b>	burner head for burner cap ø 100mm ext. ø 130		
<b>For models:</b>	G2FS4, G4F+FCD8, G4F+FSD8, G4FD8		

	1			
<b>Part No.</b>	104100	<b>Ref. No.</b>	22282700	
<b>description</b>	burner head for burner cap ø 80mm			
<b>For models:</b>	G2FS4, G4F+FCD8, G4F+FSD8, G4FD8			
<b>accessories for</b>	104100			
	<b>Part No.</b>	103065	<b>Ref. No.</b>	22284800
	burner ring for burner cap ø 80mm			
	<b>Part No.</b>	103066	<b>Ref. No.</b>	22294100
	burner cap ø 80mm			
	<b>Part No.</b>	104103	<b>Ref. No.</b>	22993100
	burner holder suitable for burner ø100mm with nozzle holder			

	1			
<b>Part No.</b>	104101	<b>Ref. No.</b>	22992900	
<b>description</b>	burner holder for burner cap ø 80mm with nozzle holder with mixing sleeve			
<b>For models:</b>	G4F+FCD8, G4F+FSD8			
<b>accessories for</b>	104101			
	<b>Part No.</b>	103065	<b>Ref. No.</b>	22284800
	burner ring for burner cap ø 80mm			
	<b>Part No.</b>	103066	<b>Ref. No.</b>	22294100
	burner cap ø 80mm			
	<b>Part No.</b>	104100	<b>Ref. No.</b>	22282700
	burner head for burner cap ø 80mm			



	1			
<b>Part No.</b>	104103	<b>Ref. No.</b>	22993100	
<b>description</b>	burner holder suitable for burner ø100mm with nozzle holder			
<b>For models:</b>	G4F+FCD8, G4F+FSD8			
<b>accessories for</b>	104103			
	<b>Part No.</b>	103067	<b>Ref. No.</b>	22285300
	burner ring for burner cap ø 100mm			
	<b>Part No.</b>	103068	<b>Ref. No.</b>	22294500
	burner cap ø 100mm			





Table continues overleaf





gas burners

hob burners

universal hob burners





GEV





	1			
<b>Part No.</b>	103068	<b>Ref. No.</b>	22294500	
<b>description</b>	burner cap ø 100mm			
<b>For models:</b>	G2FS4, G4F+FCD8, G4F+FSD8, G4FD8			
<b>accessories for</b>	103068			
	<b>Part No.</b>	103067	<b>Ref. No.</b>	22285300
	burner ring for burner cap ø 100mm			
	<b>Part No.</b>	104102	<b>Ref. No.</b>	22283200
	burner head for burner cap ø 100mm ext. ø 130			
	<b>Part No.</b>	104103	<b>Ref. No.</b>	22993100
	burner holder suitable for burner ø100mm with nozzle holder			

	1			
<b>Part No.</b>	103066	<b>Ref. No.</b>	22294100	
<b>description</b>	burner cap ø 80mm			
<b>For models:</b>	G2FS4, G4F+FCD8, G4F+FSD8, G4FD8			
<b>accessories for</b>	103066			
	<b>Part No.</b>	103065	<b>Ref. No.</b>	22284800
	burner ring for burner cap ø 80mm			
	<b>Part No.</b>	104100	<b>Ref. No.</b>	22282700
	burner head for burner cap ø 80mm			
	<b>Part No.</b>	104101	<b>Ref. No.</b>	22992900
	burner holder for burner cap ø 80mm with nozzle holder with mixing sleeve			



accessories for	104103		
	<b>Part No.</b>	104102	Ref. No. 22283200
	burner head for burner cap ø 100mm ext. ø 130		

	1		
<b>Part No.</b>	103067	<b>Ref. No.</b>	22285300
<b>description</b>	burner ring for burner cap ø 100mm		
<b>For models:</b>	G2FS4, G4F+FCD8, G4F+FSD8, G4FD8		
accessories for	103067		
	<b>Part No.</b>	103068	Ref. No. 22294500
	burner cap ø 100mm		
	<b>Part No.</b>	104102	Ref. No. 22283200
	burner head for burner cap ø 100mm ext. ø 130		
	<b>Part No.</b>	104103	Ref. No. 22993100
	burner holder suitable for burner ø100mm with nozzle holder		

	1		
<b>Part No.</b>	103065	<b>Ref. No.</b>	22284800
<b>description</b>	burner ring for burner cap ø 80mm		
<b>For models:</b>	G2FS4, G4F+FCD8, G4F+FSD8, G4FD8		
accessories for	103065		
	<b>Part No.</b>	103066	Ref. No. 22294100
	burner cap ø 80mm		
	<b>Part No.</b>	104100	Ref. No. 22282700
	burner head for burner cap ø 80mm		
	<b>Part No.</b>	104101	Ref. No. 22992900
	burner holder for burner cap ø 80mm with nozzle holder with mixing sleeve		

<b>ARC</b>			
<b>O4 series</b>			
	1		
<b>Part No.</b>	103166	<b>Ref. No.</b>	31283300
<b>description</b>	burner cap C ø 92mm mounting ø 85mm 3.5kW		
<b>For models:</b>	G6F2BPW, G6F2BPW+AE, G6F2MPW, G6F2MPW+AE, G6F4BPW, G6F4BPW+AE, G6F4MPW, G6F4MPW+AE, G6F4PW+FE1, G6F4PW+FE1+AE, G6F4PW+FG1, G6F4PW+FG1+AE, G6F6BPW, G6F6BPW+AE, G6F6MPW, G6F6MPW+AE, G6F6PW+FE1, G6F6PW+FE1+AE, G6F6PW+FG1, G6F6PW+FG1+AE, G6F6PW+T, G6F6PW+T+AE, G6F6PW+TE, G6F6PW+TE+AE, G7F2BPW, G7F2BPW+AE, G7F2BPW-F, G7F2MPW, G7F2MPW+AE, G7F4BPW, G7F4BPW+AE, G7F4MPW, G7F4MPW+AE, G7F4PW+FE, G7F4PW+FE+AE, G7F4PW+FE1, G7F-4PW+FE1+AE, G7F4PW+FG, G7F4PW+FG+AE, G7F4PW+FG1, G7F-4PW+FG1+AE, G7F6BPW, G7F6BPW+AE, G7F6MPW, G7F6MPW+AE, G7F6PW+FE, G7F6PW+FE+AE, G7F6PW+FE1, G7F6PW+FE1+AE, G7F6PW+FG... (Other models you can see in the webshop)		

	1		
<b>Part No.</b>	103170	<b>Ref. No.</b>	31283600
<b>description</b>	burner cap D ø 121mm mounting ø 113mm 6kW		
<b>For models:</b>	G6F2BPW, G6F2BPW+AE, G6F2MPW, G6F2MPW+AE, G6F4BPW, G6F4BPW+AE, G6F4MPW, G6F4MPW+AE, G6F4PW+FE1, G6F4PW+FE1+AE, G6F4PW+FG1, G6F4PW+FG1+AE, G6F6BPW, G6F6BPW+AE, G6F6MPW, G6F6MPW+AE, G6F6PW+FE1, G6F6PW+FE1+AE, G6F6PW+FG1, G6F6PW+FG1+AE, G6F6PW+T, G6F6PW+T+AE, G6F6PW+TE, G6F6PW+TE+AE, G7F2BPW, G7F2BPW+AE, G7F2BPW-F, G7F2MPW, G7F2MPW+AE, G7F4BPW, G7F4BPW+AE, G7F4MPW, G7F4MPW+AE, G7F4PW+FE, G7F4PW+FE+AE, G7F4PW+FE1, G7F-4PW+FE1+AE, G7F4PW+FG, G7F4PW+FG+AE, G7F4PW+FG1, G7F-4PW+FG1+AE, G7F6BPW, G7F6BPW+AE, G7F6MPW, G7F6MPW+AE, G7F6PW+FE, G7F6PW+FE+AE, G7F6PW+FE1, G7F6PW+FE1+AE, G7F6PW+FG... (Other models you can see in the webshop)		

	1		
<b>Part No.</b>	103167	<b>Ref. No.</b>	31283200
<b>description</b>	burner head C 3.5kW for burner cap ø 92mm ED ø 94mm mounting thread M4x0.75		
<b>For models:</b>	G6F2BPW, G6F2MPW, G6F4BPW, G6F4MPW, G6F4PW+FE1, G6F-4PW+FG1, G6F6BPW, G6F6MPW, G6F6PW+FE1, G6F6PW+FG1, G6F6PW+T, G6F6PW+TE, G7F2BPW, G7F2MPW, G7F4BPW, G7F4MPW, G7F4PW+FE, G7F4PW+FE1, G7F4PW+FG, G7F4PW+FG1, G7F6BPW, G7F6MPW, G7F6PW+FE, G7F6PW+FE1, G7F6PW+FG, G7F6PW+FG1, G7F6PW+T		
accessories for	103167		
	<b>Part No.</b>	103168	Ref. No. —
	venturi L 52mm total length 60mm ED ø 21mm ID ø 13.5mm M20x1 WS 27		

	1		
<b>Part No.</b>	103171	<b>Ref. No.</b>	31283500
<b>description</b>	burner head D 6kW for burner cap ø 121mm ED ø 123mm mounting thread M4x0.75		
<b>For models:</b>	G6F2BPW, G6F2MPW, G6F4BPW, G6F4MPW, G6F4PW+FE1, G6F-4PW+FG1, G6F6BPW, G6F6MPW, G6F6PW+FE1, G6F6PW+FG1, G6F6PW+T, G6F6PW+TE, G7F2BPW, G7F2MPW, G7F4BPW, G7F4MPW, G7F4PW+FE, G7F4PW+FE1, G7F4PW+FG, G7F4PW+FG1, G7F6BPW, G7F6MPW, G7F6PW+FE, G7F6PW+FE1, G7F6PW+FG, G7F6PW+FG1, G7F6PW+T, G9F2MPW, G9F4MPW, G9F4PW+FE, G9F4PW+FE1, G9F4PW+FG, G9F4PW+FG1, G9F6MPW, G9F6PW+FE, G9F6PW+FE1, G9F6PW+FG, G9F6PW+FG1, G9F6PW+T		
accessories for	103171		
	<b>Part No.</b>	103172	Ref. No. —
	venturi L 79mm total length 90mm D1 ø 26mm D2 ø 21mm ID ø 15mm M25x1 WS 27		













			
<b>1</b>			
<b>Part No.</b>	103169	<b>Ref. No.</b>	32328000
<b>description</b>	nozzle holder gas connection M14x1mm tube ø 10mm nozzle connection M8x0.75		
<b>For models:</b>	G6F2BPW, G6F2BPW+AE, G6F2MPW, G6F2MPW+AE, G6F4BPW, G6F4BPW+AE, G6F4MPW, G6F4MPW+AE, G6F4PW+FE1, G6F4PW+FE1+AE, G6F4PW+FG1, G6F4PW+FG1+AE, G6F6BPW, G6F6BPW+AE, G6F6MPW, G6F6MPW+AE, G6F6PW+FE1, G6F6PW+FE1+AE, G6F6PW+FG1, G6F6PW+FG1+AE, G6F6PW+T, G6F6PW+T+AE, G6F6PW+TE, G6F6PW+TE+AE, G7F2BPW, G7F2BPW+AE, G7F2BPW-F, G7F2MPW, G7F2MPW+AE, G7F4BPW, G7F4BPW+AE, G7F4MPW, G7F4MPW+AE, G7F4PW+FE, G7F4PW+FE+AE, G7F4PW+FE1, G7F-4PW+FE1+AE, G7F4PW+FG, G7F4PW+FG+AE, G7F4PW+FG1, G7F-4PW+FG1+AE, G7F6BPW, G7F6BPW+AE, G7F6MPW, G7F6MPW+AE, G7F6PW+FE, G7F6PW+FE+AE, G7F6PW+FE1, G7F6PW+FE1+AE, G7F6PW+FG... (Other models you can see in the webshop)		
<b>accessories for</b>	103169		
	<b>Part No.</b>	104808	<b>Ref. No.</b> 40312000
	<b>Part No.</b>	107506	<b>Ref. No.</b> 32811600
	<b>Part No.</b>	107507	<b>Ref. No.</b> 32777200

## SABAF

## 1 series

			
<b>1</b>			
<b>Part No.</b>	104288	<b>Ref. No.</b>	31280700 31281300
<b>description</b>	burner cap 3.6kW ø 120mm		
<b>For models:</b>	G6F2B, G6F2B+A2, G6F2M, G6F2M+A2, G6F4+FE1, G6F4+FE1+A4, G6F4+FG1, G6F4+FG1+A4, G6F4B, G6F4B+A4, G6F4M, G6F4M+A4, G6F6+FE1, G6F6+FE1+A6, G6F6+FG1, G6F6+FG1+A6, G6F6+T, G6F6+T+A6, G6F6+TE, G6F6+TE+A6, G6F6B, G6F6B+A6, G6F6M, G6F6M+A6, G7F2BE, G7F2BE+A2, G7F2ME, G7F2ME+A2, G7F4BE, G7F4BE+A4, G7F4E+FE, G7F4E+FE+A4, G7F4E+FE1, G7F4E+FE1+A4, G7F4E+FG, G7F4E+FG+A4, G7F4E+FG1, G7F4E+FG1+A4, G7F4ME, G7F4ME+A4, G7F6BE, G7F6BE+A6, G7F6E+FE, G7F6E+FE+A6, G7F6E+FE1, G7F6E+FE1+A6, G7F6E+FG, G7F6E+FG+A4, G7F6E+FG+A6, G7F6E+FG1... (Other models you can see in the webshop)		
<b>accessories for</b>	104288		
	<b>Part No.</b>	104289	<b>Ref. No.</b> 31280100
	<b>Part No.</b>	105086	<b>Ref. No.</b> 31280600
	<b>Part No.</b>	105087	<b>Ref. No.</b> 31280500

			
<b>1</b>			
<b>Part No.</b>	104286	<b>Ref. No.</b>	31280400 31281000
<b>description</b>	burner cap 3kW ø 90mm		
<b>For models:</b>	G6F2B, G6F2B+A2, G6F2M, G6F2M+A2, G6F4+FE1, G6F4+FE1+A4, G6F4+FG1, G6F4+FG1+A4, G6F4B, G6F4B+A4, G6F4M, G6F4M+A4, G6F6+FE1, G6F6+FE1+A6, G6F6+FG1, G6F6+FG1+A6, G6F6+T, G6F6+T+A6, G6F6+TE, G6F6+TE+A6, G6F6B, G6F6B+A6, G6F6M, G6F6M+A6, G7F2BE, G7F2BE+A2, G7F2ME, G7F2ME+A2, G7F4BE, G7F4BE+A4, G7F4E+FE, G7F4E+FE+A4, G7F4E+FE1, G7F4E+FE1+A4, G7F4E+FG, G7F4E+FG+A4, G7F4E+FG1, G7F4E+FG1+A4, G7F4ME, G7F4ME+A4, G7F6BE, G7F6BE+A6, G7F6E+FE, G7F6E+FE+A6, G7F6E+FE1, G7F6E+FE1+A6, G7F6E+FG, G7F6E+FG+A4, G7F6E+FG+A6, G7F6E+FG1... (Other models you can see in the webshop)		
<b>accessories for</b>	104286		
	<b>Part No.</b>	104289	<b>Ref. No.</b> 31280100
	<b>Part No.</b>	105089	<b>Ref. No.</b> 31280300
	<b>Part No.</b>	105090	<b>Ref. No.</b> 31280200



			
<b>1</b>			
<b>Part No.</b>	105087	<b>Ref. No.</b>	31280500
<b>description</b>	burner head 3.6kW for burner cap ø 120mm		
<b>For models:</b>	G6F2B, G6F2B+A2, G6F2M, G6F2M+A2, G6F4+FE1, G6F4+FE1+A4, G6F4+FG1, G6F4+FG1+A4, G6F4B, G6F4B+A4, G6F4M, G6F4M+A4, G6F6+FE1, G6F6+FE1+A6, G6F6+FG1, G6F6+FG1+A6, G6F6+T, G6F6+T+A6, G6F6+TE, G6F6+TE+A6, G6F6B, G6F6B+A6, G6F6M, G6F6M+A6, G7F2BE, G7F2BE+A2, G7F2ME, G7F2ME+A2, G7F4BE, G7F4BE+A4, G7F4E+FE, G7F4E+FE+A4, G7F4E+FE1, G7F4E+FE1+A4, G7F4E+FG, G7F4E+FG+A4, G7F4E+FG1, G7F4E+FG1+A4, G7F4ME, G7F4ME+A4, G7F6BE, G7F6BE+A6, G7F6E+FE, G7F6E+FE+A6, G7F6E+FE1, G7F6E+FE1+A6, G7F6E+FG, G7F6E+FG+A4, G7F6E+FG+A6, G7F6E+FG1... (Other models you can see in the webshop)		
<b>accessories for</b>	105087		
	<b>Part No.</b>	104288	<b>Ref. No.</b> 31280700 31281300
	<b>Part No.</b>	105085	<b>Ref. No.</b> —
	<b>Part No.</b>	105086	<b>Ref. No.</b> 31280600
	<b>Part No.</b>	105088	<b>Ref. No.</b> —
	<b>Part No.</b>	105089	<b>Ref. No.</b> 31280300



			
<b>Part No.</b>	105090	<b>Ref. No.</b>	31280200
<b>description</b>	burner head 3kW for burner cap ø 90mm		
<b>For models:</b>	G6F2B, G6F2B+A2, G6F2M, G6F2M+A2, G6F4+FE1, G6F4+FE1+A4, G6F4+FG1, G6F4+FG1+A4, G6F4B, G6F4B+A4, G6F4M, G6F4M+A4, G6F6+FE1, G6F6+FE1+A6, G6F6+FG1, G6F6+FG1+A6, G6F6+T, G6F6+T+A6, G6F6+TE, G6F6+TE+A6, G6F6B, G6F6B+A6, G6F6M, G6F6M+A6, G7F2BE, G7F2BE+A2, G7F2ME, G7F2ME+A2, G7F4BE, G7F4BE+A4, G7F4E+FE, G7F4E+FE+A4, G7F4E+FE1, G7F4E+FE1+A4, G7F4E+FG, G7F4E+FG+A4, G7F4E+FG1, G7F4E+FG1+A4, G7F4ME, G7F4ME+A4, G7F6BE, G7F6BE+A6, G7F6E+FE, G7F6E+FE+A6, G7F6E+FE1, G7F6E+FE1+A6, G7F6E+FG, G7F6E+FG+A4, G7F6E+FG+A6, G7F6E+FG1...(Other models you can see in the webshop)		
<b>accessories for</b>	105090		
		<b>Part No.</b>	104286      Ref. No.      31280400 31281000
	burner cap 3kW ø 90mm		
		<b>Part No.</b>	104289      Ref. No.      31280100
	burner lower part 3/3.6kW for burner cap ø 90/120mm		
		<b>Part No.</b>	105089      Ref. No.      31280300
	burner ring 3kW for burner cap ø 90mm		

			
<b>Part No.</b>	104289	<b>Ref. No.</b>	31280100
<b>description</b>	burner lower part 3/3.6kW for burner cap ø 90/120mm		
<b>For models:</b>	G6F2B, G6F2B+A2, G6F2M, G6F2M+A2, G6F4+FE1, G6F4+FE1+A4, G6F4+FG1, G6F4+FG1+A4, G6F4B, G6F4B+A4, G6F4M, G6F4M+A4, G6F6+FE1, G6F6+FE1+A6, G6F6+FG1, G6F6+FG1+A6, G6F6+T, G6F6+T+A6, G6F6+TE, G6F6+TE+A6, G6F6B, G6F6B+A6, G6F6M, G6F6M+A6, G7F2BE, G7F2BE+A2, G7F2ME, G7F2ME+A2, G7F4BE, G7F4BE+A4, G7F4E+FE, G7F4E+FE+A4, G7F4E+FE1, G7F4E+FE1+A4, G7F4E+FG, G7F4E+FG+A4, G7F4E+FG1, G7F4E+FG1+A4, G7F4ME, G7F4ME+A4, G7F6BE, G7F6BE+A6, G7F6E+FE, G7F6E+FE+A6, G7F6E+FE1, G7F6E+FE1+A6, G7F6E+FG, G7F6E+FG+A4, G7F6E+FG+A6, G7F6E+FG1...(Other models you can see in the webshop)		
<b>accessories for</b>	104289		
		<b>Part No.</b>	104286      Ref. No.      31280400 31281000
	burner cap 3kW ø 90mm		
		<b>Part No.</b>	104288      Ref. No.      31280700 31281300
	burner cap 3.6kW ø 120mm		
		<b>Part No.</b>	105086      Ref. No.      31280600
	burner ring 3.6kW for burner cap ø 120mm		
		<b>Part No.</b>	105087      Ref. No.      31280500
	burner head 3.6kW for burner cap ø 120mm		
		<b>Part No.</b>	105089      Ref. No.      31280300
	burner ring 3kW for burner cap ø 90mm		
		<b>Part No.</b>	105090      Ref. No.      31280200
	burner head 3kW for burner cap ø 90mm		
		<b>Part No.</b>	106482      Ref. No.      —
	gas injector thread M6x0.75 WS 7 bore ø 1.1mm		

<b>accessories for</b>	104289		
		<b>Part No.</b>	106485      Ref. No.      —
	gas injector thread M6x0.75 WS 7 bore ø 1.6mm		

			
<b>Part No.</b>	105086	<b>Ref. No.</b>	31280600
<b>description</b>	burner ring 3.6kW for burner cap ø 120mm		
<b>For models:</b>	G6F2B, G6F2B+A2, G6F2M, G6F2M+A2, G6F4+FE1, G6F4+FE1+A4, G6F4+FG1, G6F4+FG1+A4, G6F4B, G6F4B+A4, G6F4M, G6F4M+A4, G6F6+FE1, G6F6+FE1+A6, G6F6+FG1, G6F6+FG1+A6, G6F6+T, G6F6+T+A6, G6F6+TE, G6F6+TE+A6, G6F6B, G6F6B+A6, G6F6M, G6F6M+A6, G7F2BE, G7F2BE+A2, G7F2ME, G7F2ME+A2, G7F4BE, G7F4BE+A4, G7F4E+FE, G7F4E+FE+A4, G7F4E+FE1, G7F4E+FE1+A4, G7F4E+FG, G7F4E+FG+A4, G7F4E+FG1, G7F4E+FG1+A4, G7F4ME, G7F4ME+A4, G7F6BE, G7F6BE+A6, G7F6E+FE, G7F6E+FE+A6, G7F6E+FE1, G7F6E+FE1+A6, G7F6E+FG, G7F6E+FG+A4, G7F6E+FG+A6, G7F6E+FG1...(Other models you can see in the webshop)		
<b>accessories for</b>	105086		
		<b>Part No.</b>	105085      Ref. No.      —
	burner cap ø 120mm		
		<b>Part No.</b>	105087      Ref. No.      31280500
	burner head 3.6kW for burner cap ø 120mm		
		<b>Part No.</b>	105088      Ref. No.      —
	burner cap A ø 110mm with central hole		
		<b>Part No.</b>	105089      Ref. No.      31280300
	burner ring 3kW for burner cap ø 90mm		

			
<b>Part No.</b>	105089	<b>Ref. No.</b>	31280300
<b>description</b>	burner ring 3kW for burner cap ø 90mm		
<b>For models:</b>	G6F2B, G6F2B+A2, G6F2M, G6F2M+A2, G6F4+FE1, G6F4+FE1+A4, G6F4+FG1, G6F4+FG1+A4, G6F4B, G6F4B+A4, G6F4M, G6F4M+A4, G6F6+FE1, G6F6+FE1+A6, G6F6+FG1, G6F6+FG1+A6, G6F6+T, G6F6+T+A6, G6F6+TE, G6F6+TE+A6, G6F6B, G6F6B+A6, G6F6M, G6F6M+A6, G7F2BE, G7F2BE+A2, G7F2ME, G7F2ME+A2, G7F4BE, G7F4BE+A4, G7F4E+FE, G7F4E+FE+A4, G7F4E+FE1, G7F4E+FE1+A4, G7F4E+FG, G7F4E+FG+A4, G7F4E+FG1, G7F4E+FG1+A4, G7F4ME, G7F4ME+A4, G7F6BE, G7F6BE+A6, G7F6E+FE, G7F6E+FE+A6, G7F6E+FE1, G7F6E+FE1+A6, G7F6E+FG, G7F6E+FG+A4, G7F6E+FG+A6, G7F6E+FG1...(Other models you can see in the webshop)		
<b>accessories for</b>	105089		
		<b>Part No.</b>	104286      Ref. No.      31280400 31281000
	burner cap 3kW ø 90mm		
		<b>Part No.</b>	104289      Ref. No.      31280100
	burner lower part 3/3.6kW for burner cap ø 90/120mm		
		<b>Part No.</b>	105090      Ref. No.      31280200
	burner head 3kW for burner cap ø 90mm		

1 gas components



## 2 series - flat skirt version



<b>Part No.</b>	105700	<b>Ref. No.</b>	35281300
<b>description</b>	burner cap		
<b>For models:</b>	G9F2ME, G9F2ME+A2, G9F4E+FE1, G9F4E+FE1+A4, G9F4E+FG1, G9F4E+FG1+A4, G9F4ME, G9F4ME+A4, G9F6E+FE1, G9F6E+FE1+A6, G9F6E+FG1, G9F6E+FG1+A6, G9F6ME, G9F6ME+A6		

## triple ring burner series - standard version





<b>Part No.</b>	105700	<b>Ref. No.</b>	35281300
<b>description</b>	burner cap		
<b>For models:</b>	G9F2ME, G9F2ME+A2, G9F4E+FE1, G9F4E+FE1+A4, G9F4E+FG1, G9F4E+FG1+A4, G9F4ME, G9F4ME+A4, G9F6E+FE1, G9F6E+FE1+A6, G9F6E+FG1, G9F6E+FG1+A6, G9F6ME, G9F6ME+A6		



<b>Part No.</b>	105721	<b>Ref. No.</b>	35280500 35280600
<b>description</b>	burner head 3.6kW for burner cap ø 131mm		
<b>For models:</b>	G9F2ME, G9F2ME+A2, G9F4E+FE1, G9F4E+FE1+A4, G9F4E+FG1, G9F4E+FG1+A4, G9F4ME, G9F4ME+A4, G9F6E+FE1, G9F6E+FE1+A6, G9F6E+FG1, G9F6E+FG1+A6, G9F6ME, G9F6ME+A6		



<b>Part No.</b>	105717	<b>Ref. No.</b>	35280100
<b>description</b>	burner lower part 3.6kW for igniter ø 6mm with nozzle ø1.35mm ID ø 64mm for burner cap ø 61/131mm		
<b>For models:</b>	G9F2ME, G9F2ME+A2, G9F4E+FE1, G9F4E+FE1+A4, G9F4E+FG1, G9F4E+FG1+A4, G9F4ME, G9F4ME+A4, G9F6E+FE1, G9F6E+FE1+A6, G9F6E+FG1, G9F6E+FG1+A6, G9F6ME, G9F6ME+A6		

<b>accessories for</b>	105717		
	<b>Part No.</b>	101277	Ref. No. —
	olive ID ø 8mm Qty 1 pcs		
	<b>Part No.</b>	101477	Ref. No. —
	union screw thread M13x1 tube ø 8mm Qty 1 pcs		

## triple ring burner series - flat skirt version



<b>Part No.</b>	105717	<b>Ref. No.</b>	35280100
<b>description</b>	burner lower part 3.6kW for igniter ø 6mm with nozzle ø1.35mm ID ø 64mm for burner cap ø 61/131mm		
<b>For models:</b>	G9F2ME, G9F2ME+A2, G9F4E+FE1, G9F4E+FE1+A4, G9F4E+FG1, G9F4E+FG1+A4, G9F4ME, G9F4ME+A4, G9F6E+FE1, G9F6E+FE1+A6, G9F6E+FG1, G9F6E+FG1+A6, G9F6ME, G9F6ME+A6		

<b>accessories for</b>	105717		
------------------------	--------	--	--



<b>Part No.</b>	101277	<b>Ref. No.</b>	—
-----------------	--------	-----------------	---

olive ID ø 8mm Qty 1 pcs



<b>Part No.</b>	101477	<b>Ref. No.</b>	—
-----------------	--------	-----------------	---

union screw thread M13x1 tube ø 8mm Qty 1 pcs

## producer-specific hob burners

## BERTO'S

## 700 Macros, 900 Maxima (1) series



<b>Part No.</b>	105699	<b>Ref. No.</b>	35281400
<b>description</b>	burner cap		
<b>For models:</b>	G9F2ME, G9F2ME+A2, G9F4E+FE1, G9F4E+FE1+A4, G9F4E+FG1, G9F4E+FG1+A4, G9F4ME, G9F4ME+A4, G9F6E+FE1, G9F6E+FE1+A6, G9F6E+FG1, G9F6E+FG1+A6, G9F6ME, G9F6ME+A6		



<b>Part No.</b>	105700	<b>Ref. No.</b>	35281300
<b>description</b>	burner cap		
<b>For models:</b>	G9F2ME, G9F2ME+A2, G9F4E+FE1, G9F4E+FE1+A4, G9F4E+FG1, G9F4E+FG1+A4, G9F4ME, G9F4ME+A4, G9F6E+FE1, G9F6E+FE1+A6, G9F6E+FG1, G9F6E+FG1+A6, G9F6ME, G9F6ME+A6		



<b>Part No.</b>	104288	<b>Ref. No.</b>	31280700 31281300
-----------------	--------	-----------------	----------------------

<b>description</b>	burner cap 3.6kW ø 120mm		
<b>For models:</b>	G6F2B, G6F2B+A2, G6F2M, G6F2M+A2, G6F4+FE1, G6F4+FE1+A4, G6F4+FG1, G6F4+FG1+A4, G6F4B, G6F4B+A4, G6F4M, G6F4M+A4, G6F6+FE1, G6F6+FE1+A6, G6F6+FG1, G6F6+FG1+A6, G6F6+T, G6F6+T+A6, G6F6+TE, G6F6+TE+A6, G6F6B, G6F6B+A6, G6F6M, G6F6M+A6, G7F2BE, G7F2BE+A2, G7F2ME, G7F2ME+A2, G7F4BE, G7F4BE+A4, G7F4E+FE, G7F4E+FE+A4, G7F4E+FE1, G7F4E+FE1+A4, G7F4E+FG, G7F4E+FG+A4, G7F4E+FG1, G7F4E+FG1+A4, G7F4ME, G7F4ME+A4, G7F6BE, G7F6BE+A6, G7F6E+FE, G7F6E+FE+A6, G7F6E+FE1, G7F6E+FE1+A6, G7F6E+FG, G7F6E+FG+A4, G7F6E+FG+A6, G7F6E+FG1...(Other models you can see in the webshop)		

<b>accessories for</b>	104288		
------------------------	--------	--	--









<b>Part No.</b>	104289	<b>Ref. No.</b>	31280100
-----------------	--------	-----------------	----------

burner lower part 3/3.6kW for burner cap ø 90/120mm

Table continues overleaf







accessories for	104288		
	<b>Part No.</b>	105086	Ref. No. 31280600
burner ring 3.6kW for burner cap ø 120mm			
	<b>Part No.</b>	105087	Ref. No. 31280500
burner head 3.6kW for burner cap ø 120mm			

	1		
<b>Part No.</b>	104286	<b>Ref. No.</b>	31280400 31281000
<b>description</b>	burner cap 3kW ø 90mm		
<b>For models:</b>	G6F2B, G6F2B+A2, G6F2M, G6F2M+A2, G6F4+FE1, G6F4+FE1+A4, G6F4+FG1, G6F4+FG1+A4, G6F4B, G6F4B+A4, G6F4M, G6F4M+A4, G6F6+FE1, G6F6+FE1+A6, G6F6+FG1, G6F6+FG1+A6, G6F6+T, G6F6+T+A6, G6F6+TE, G6F6+TE+A6, G6F6B, G6F6B+A6, G6F6M, G6F6M+A6, G7F2BE, G7F2BE+A2, G7F2ME, G7F2ME+A2, G7F4BE, G7F4BE+A4, G7F4E+FE, G7F4E+FE+A4, G7F4E+FE1, G7F4E+FE1+A4, G7F4E+FG, G7F4E+FG+A4, G7F4E+FG1, G7F4E+FG1+A4, G7F4ME, G7F4ME+A4, G7F6BE, G7F6BE+A6, G7F6E+FE, G7F6E+FE+A6, G7F6E+FE1, G7F6E+FE1+A6, G7F6E+FG, G7F6E+FG+A4, G7F6E+FG+A6, G7F6E+FG1...(Other models you can see in the webshop)		
accessories for	104286		
	<b>Part No.</b>	104289	Ref. No. 31280100
burner lower part 3/3.6kW for burner cap ø 90/120mm			
	<b>Part No.</b>	105089	Ref. No. 31280300
burner ring 3kW for burner cap ø 90mm			
	<b>Part No.</b>	105090	Ref. No. 31280200
burner head 3kW for burner cap ø 90mm			

	1		
<b>Part No.</b>	105087	<b>Ref. No.</b>	31280500
<b>description</b>	burner head 3.6kW for burner cap ø 120mm		
<b>For models:</b>	G6F2B, G6F2B+A2, G6F2M, G6F2M+A2, G6F4+FE1, G6F4+FE1+A4, G6F4+FG1, G6F4+FG1+A4, G6F4B, G6F4B+A4, G6F4M, G6F4M+A4, G6F6+FE1, G6F6+FE1+A6, G6F6+FG1, G6F6+FG1+A6, G6F6+T, G6F6+T+A6, G6F6+TE, G6F6+TE+A6, G6F6B, G6F6B+A6, G6F6M, G6F6M+A6, G7F2BE, G7F2BE+A2, G7F2ME, G7F2ME+A2, G7F4BE, G7F4BE+A4, G7F4E+FE, G7F4E+FE+A4, G7F4E+FE1, G7F4E+FE1+A4, G7F4E+FG, G7F4E+FG+A4, G7F4E+FG1, G7F4E+FG1+A4, G7F4ME, G7F4ME+A4, G7F6BE, G7F6BE+A6, G7F6E+FE, G7F6E+FE+A6, G7F6E+FE1, G7F6E+FE1+A6, G7F6E+FG, G7F6E+FG+A4, G7F6E+FG+A6, G7F6E+FG1...(Other models you can see in the webshop)		
accessories for	105087		
	<b>Part No.</b>	104288	Ref. No. 31280700 31281300
burner cap 3.6kW ø 120mm			
	<b>Part No.</b>	105085	Ref. No. —
burner cap ø 120mm			
	<b>Part No.</b>	105086	Ref. No. 31280600
burner ring 3.6kW for burner cap ø 120mm			
	<b>Part No.</b>	105088	Ref. No. —
burner cap A ø 110mm with central hole			
	<b>Part No.</b>	105089	Ref. No. 31280300
burner ring 3kW for burner cap ø 90mm			

	1		
<b>Part No.</b>	105721	<b>Ref. No.</b>	35280500 35280600
<b>description</b>	burner head 3.6kW for burner cap ø 131mm		
<b>For models:</b>	G9F2ME, G9F2ME+A2, G9F4E+FE1, G9F4E+FE1+A4, G9F4E+FG1, G9F4E+FG1+A4, G9F4ME, G9F4ME+A4, G9F6E+FE1, G9F6E+FE1+A6, G9F6E+FG1, G9F6E+FG1+A6, G9F6ME, G9F6ME+A6		

	1		
<b>Part No.</b>	105090	<b>Ref. No.</b>	31280200
<b>description</b>	burner head 3kW for burner cap ø 90mm		
<b>For models:</b>	G6F2B, G6F2B+A2, G6F2M, G6F2M+A2, G6F4+FE1, G6F4+FE1+A4, G6F4+FG1, G6F4+FG1+A4, G6F4B, G6F4B+A4, G6F4M, G6F4M+A4, G6F6+FE1, G6F6+FE1+A6, G6F6+FG1, G6F6+FG1+A6, G6F6+T, G6F6+T+A6, G6F6+TE, G6F6+TE+A6, G6F6B, G6F6B+A6, G6F6M, G6F6M+A6, G7F2BE, G7F2BE+A2, G7F2ME, G7F2ME+A2, G7F4BE, G7F4BE+A4, G7F4E+FE, G7F4E+FE+A4, G7F4E+FE1, G7F4E+FE1+A4, G7F4E+FG, G7F4E+FG+A4, G7F4E+FG1, G7F4E+FG1+A4, G7F4ME, G7F4ME+A4, G7F6BE, G7F6BE+A6, G7F6E+FE, G7F6E+FE+A6, G7F6E+FE1, G7F6E+FE1+A6, G7F6E+FG, G7F6E+FG+A4, G7F6E+FG+A6, G7F6E+FG1...(Other models you can see in the webshop)		



accessories for	105090		
	<b>Part No.</b>	104286	Ref. No. 31280400 31281000
burner cap 3kW ø 90mm			
	<b>Part No.</b>	104289	Ref. No. 31280100
burner lower part 3/3.6kW for burner cap ø 90/120mm			
	<b>Part No.</b>	105089	Ref. No. 31280300
burner ring 3kW for burner cap ø 90mm			

	1		
<b>Part No.</b>	105717	<b>Ref. No.</b>	35280100
<b>description</b>	burner lower part 3.6kW for igniter ø 6mm for thermocouple ø 6mm with nozzle ø1.35mm ID ø 64mm for burner cap ø 61/131mm		
<b>For models:</b>	G9F2ME, G9F2ME+A2, G9F4E+FE1, G9F4E+FE1+A4, G9F4E+FG1, G9F4E+FG1+A4, G9F4ME, G9F4ME+A4, G9F6E+FE1, G9F6E+FE1+A6, G9F6E+FG1, G9F6E+FG1+A6, G9F6ME, G9F6ME+A6		
accessories for	105717		
	<b>Part No.</b>	101277	Ref. No. —
olive ID ø 8mm Qty 1 pcs			
	<b>Part No.</b>	101477	Ref. No. —
union screw thread M13x1 tube ø 8mm Qty 1 pcs			



			
<b>1</b>			
<b>Part No.</b>	104289	<b>Ref. No.</b>	31280100
<b>description</b>	burner lower part 3/3.6kW for burner cap ø 90/120mm		
<b>For models:</b>	G6F2B, G6F2B+A2, G6F2M, G6F2M+A2, G6F4+FE1, G6F4+FE1+A4, G6F4+FG1, G6F4+FG1+A4, G6F4B, G6F4B+A4, G6F4M, G6F4M+A4, G6F6+FE1, G6F6+FE1+A6, G6F6+FG1, G6F6+FG1+A6, G6F6+T, G6F6+T+A6, G6F6+TE, G6F6+TE+A6, G6F6B, G6F6B+A6, G6F6M, G6F6M+A6, G7F2BE, G7F2BE+A2, G7F2ME, G7F2ME+A2, G7F4BE, G7F4BE+A4, G7F4E+FE, G7F4E+FE+A4, G7F4E+FE1, G7F4E+FE1+A4, G7F4E+FG, G7F4E+FG+A4, G7F4E+FG1, G7F4E+FG1+A4, G7F4ME, G7F4ME+A4, G7F6BE, G7F6BE+A6, G7F6E+FE, G7F6E+FE+A6, G7F6E+FE1, G7F6E+FE1+A6, G7F6E+FG, G7F6E+FG+A4, G7F6E+FG+A6, G7F6E+FG1...(Other models you can see in the webshop)		
<b>accessories for</b>	104289		
	<b>Part No.</b>	104286	<b>Ref. No.</b> 31280400 31281000
burner cap 3kW ø 90mm			
	<b>Part No.</b>	104288	<b>Ref. No.</b> 31280700 31281300
burner cap 3.6kW ø 120mm			
	<b>Part No.</b>	105086	<b>Ref. No.</b> 31280600
burner ring 3.6kW for burner cap ø 120mm			
	<b>Part No.</b>	105087	<b>Ref. No.</b> 31280500
burner head 3.6kW for burner cap ø 120mm			
	<b>Part No.</b>	105089	<b>Ref. No.</b> 31280300
burner ring 3kW for burner cap ø 90mm			
	<b>Part No.</b>	105090	<b>Ref. No.</b> 31280200
burner head 3kW for burner cap ø 90mm			
	<b>Part No.</b>	106482	<b>Ref. No.</b> —
gas injector thread M6x0.75 WS 7 bore ø 1.1mm			
	<b>Part No.</b>	106485	<b>Ref. No.</b> —
gas injector thread M6x0.75 WS 7 bore ø 1.6mm			

			
<b>1</b>			
<b>Part No.</b>	105086	<b>Ref. No.</b>	31280600
<b>description</b>	burner ring 3.6kW for burner cap ø 120mm		
<b>For models:</b>	G6F2B, G6F2B+A2, G6F2M, G6F2M+A2, G6F4+FE1, G6F4+FE1+A4, G6F4+FG1, G6F4+FG1+A4, G6F4B, G6F4B+A4, G6F4M, G6F4M+A4, G6F6+FE1, G6F6+FE1+A6, G6F6+FG1, G6F6+FG1+A6, G6F6+T, G6F6+T+A6, G6F6+TE, G6F6+TE+A6, G6F6B, G6F6B+A6, G6F6M, G6F6M+A6, G7F2BE, G7F2BE+A2, G7F2ME, G7F2ME+A2, G7F4BE, G7F4BE+A4, G7F4E+FE, G7F4E+FE+A4, G7F4E+FE1, G7F4E+FE1+A4, G7F4E+FG, G7F4E+FG+A4, G7F4E+FG1, G7F4E+FG1+A4, G7F4ME, G7F4ME+A4, G7F6BE, G7F6BE+A6, G7F6E+FE, G7F6E+FE+A6, G7F6E+FE1, G7F6E+FE1+A6, G7F6E+FG, G7F6E+FG+A4, G7F6E+FG+A6, G7F6E+FG1...(Other models you can see in the webshop)		
<b>accessories for</b>	105086		
	<b>Part No.</b>	105085	<b>Ref. No.</b> —
burner cap ø 120mm			
	<b>Part No.</b>	105087	<b>Ref. No.</b> 31280500
burner head 3.6kW for burner cap ø 120mm			

<b>accessories for</b>	105086		
	<b>Part No.</b>	105088	<b>Ref. No.</b> —
burner cap A ø 110mm with central hole			
	<b>Part No.</b>	105089	<b>Ref. No.</b> 31280300
burner ring 3kW for burner cap ø 90mm			

			
<b>1</b>			
<b>Part No.</b>	105089	<b>Ref. No.</b>	31280300
<b>description</b>	burner ring 3kW for burner cap ø 90mm		
<b>For models:</b>	G6F2B, G6F2B+A2, G6F2M, G6F2M+A2, G6F4+FE1, G6F4+FE1+A4, G6F4+FG1, G6F4+FG1+A4, G6F4B, G6F4B+A4, G6F4M, G6F4M+A4, G6F6+FE1, G6F6+FE1+A6, G6F6+FG1, G6F6+FG1+A6, G6F6+T, G6F6+T+A6, G6F6+TE, G6F6+TE+A6, G6F6B, G6F6B+A6, G6F6M, G6F6M+A6, G7F2BE, G7F2BE+A2, G7F2ME, G7F2ME+A2, G7F4BE, G7F4BE+A4, G7F4E+FE, G7F4E+FE+A4, G7F4E+FE1, G7F4E+FE1+A4, G7F4E+FG, G7F4E+FG+A4, G7F4E+FG1, G7F4E+FG1+A4, G7F4ME, G7F4ME+A4, G7F6BE, G7F6BE+A6, G7F6E+FE, G7F6E+FE+A6, G7F6E+FE1, G7F6E+FE1+A6, G7F6E+FG, G7F6E+FG+A4, G7F6E+FG+A6, G7F6E+FG1...(Other models you can see in the webshop)		
<b>accessories for</b>	105089		
	<b>Part No.</b>	104286	<b>Ref. No.</b> 31280400 31281000
burner cap 3kW ø 90mm			
	<b>Part No.</b>	104289	<b>Ref. No.</b> 31280100
burner lower part 3/3.6kW for burner cap ø 90/120mm			
	<b>Part No.</b>	105090	<b>Ref. No.</b> 31280200
burner head 3kW for burner cap ø 90mm			

## 700 Macros, 900 Maxima (2) series

			
<b>1</b>			
<b>Part No.</b>	106934	<b>Ref. No.</b>	31834100
<b>description</b>	air mixing sleeve ID ø 42mm H 40mm		

			
<b>1</b>			
<b>Part No.</b>	105095	<b>Ref. No.</b>	31954400
<b>description</b>	burner cap ø 80mm 3.5kW		
<b>For models:</b>	G12F4H9+FGP, G12F4H9M, G6F2B, G6F2B+A2, G6F2BH6, G6F2BH9, G6F2H6+FE1, G6F2H6+FG1, G6F2H9+FE1, G6F2H9+FG1, G6F2H9+T, G6F2H9+TE, G6F2MH6, G6F2MH9, G6F2P9+TE, G6F3BH9, G6F3H9+T, G6F4B, G6F4B+A4, G6F6B, G6F6B+A6, G7F2B, G7F2M, G7F4+FE, G7F4+FE1, G7F4+FES, G7F4+FG, G7F4+FG1, G7F4B, G7F4M, G7F6+FE, G7F6+FE1, G7F6+FES, G7F6+FG, G7F6+FG1, G7F6+T, G7F6B, G7F6M, G7T4P2F+FG1, G7T4P2FB, G7T4P2FM, G7T4P4F+FG, G7T4P4F+FG1, G7T4P4FB, G7T4P4FM, G7TP2F+FG, G7TP2F+FG1, G7TP2F+T, G7TP2FM, G9F2M...(Other models you can see in the webshop)		
<b>accessories for</b>	105095		
	<b>Part No.</b>	105094	<b>Ref. No.</b> 31913600
burner holder 3.5/6kW for burner cap ø 80/110mm			
	<b>Part No.</b>	105096	<b>Ref. No.</b> 31807200
burner head 3.5kW for burner cap ø 80mm			

Table continues overleaf





accessories for	105095		
	<b>Part No.</b>	105097	Ref. No. 32327600
	nozzle holder nozzle mounting M10x1 tube ø 10mm gas inlet M16x1.5 gas outlet M14x1		



<b>Part No.</b>	105092	<b>Ref. No.</b>	31954300
<b>description</b>	burner cap with central hole ø 110mm 6kW		
<b>For models:</b>	G12F4H9+FGP, G12F4H9M, G6F2B, G6F2B+A2, G6F2BH6, G6F2BP6, G6F2H6+FE1, G6F2H6+FG1, G6F2MH6, G6F2MP6, G6F2P6+FE1, G6F2P6+FG1, G6F3BH12, G6F3BH9, G6F3H12+FE1, G6F3H12+FG1, G6F3H12+T, G6F3H12+TE, G6F3H9+T, G6F3MH12, G6F4B, G6F4B+A4, G6F6B, G6F6B+A6, G7F2B, G7F2BP, G7F2M, G7F2MP, G7F4+FE, G7F4+FE1, G7F4+FES, G7F4+FG, G7F4+FG1, G7F4B, G7F4BP, G7F4M, G7F4MP, G7F4P+FG, G7F4P+FG+AF2, G7F4P+FG1, G7F4P+FG1+AF1, G7F6+FE, G7F6+FE1, G7F6+FES, G7F6+FG, G7F6+FG1, G7F6+T, G7F6B, G7F6BP, G7F6M...(Other models you can see in the webshop)		

accessories for	105092		
-----------------	--------	--	--

	<b>Part No.</b>	105093	Ref. No. 31807000
	burner head 6kW for burner cap ø 110mm		

	<b>Part No.</b>	105097	Ref. No. 32327600
	nozzle holder nozzle mounting M10x1 tube ø 10mm gas inlet M16x1.5 gas outlet M14x1		

	<b>Part No.</b>	107691	Ref. No. 35912600
	burner holder D/E ø 33mm for burner cap ø 130/140mm		



<b>Part No.</b>	105726	<b>Ref. No.</b>	35954300
<b>description</b>	burner cap with central hole ø 130mm 9kW		
<b>For models:</b>	G12F4H9M, G12F4P9+FGP, G12F4P9M, G6F2BH9, G6F2BP9, G6F2H9+FE1, G6F2H9+FG1, G6F2H9+T, G6F2H9+TE, G6F2MH9, G6F2MP9, G6F2P9+FE1, G6F2P9+FG1, G6F2P9+T, G6F2P9+TE, G6F3BH12, G6F3BH9, G6F3H12+FE1, G6F3H12+FG1, G6F3H12+T, G6F3H12+TE, G6F3H9+T, G6F3MH12, G9F2M, G9F2MP, G9F4+FE, G9F4+FE1, G9F4+FG, G9F4+FG1, G9F4M, G9F4MP, G9F4P+FG, G9F4P+FG+AF2, G9F4P+FG1, G9F4P+FG1+AF1, G9F6+FE, G9F6+FE1, G9F6+FG, G9F6+FG1, G9F6+T, G9F6M, G9F6MP, G9F6P+FG, G9F6P+FG+AF2, G9F6P+FG1, G9F6P+T, G9F6P+T+AF2, G9F8+2FE, G9F8+2FE1, G9F8+2FG...(Other models you can see in the webshop)		

accessories for	105726		
-----------------	--------	--	--

	<b>Part No.</b>	105097	Ref. No. 32327600
	nozzle holder nozzle mounting M10x1 tube ø 10mm gas inlet M16x1.5 gas outlet M14x1		

	<b>Part No.</b>	105725	Ref. No. 35807000
	burner head 9kW for burner cap ø 130mm		

	<b>Part No.</b>	105727	Ref. No. 31781300 31782500
	bar burner angled ømm W 240mm Hmm L 560mm oven		

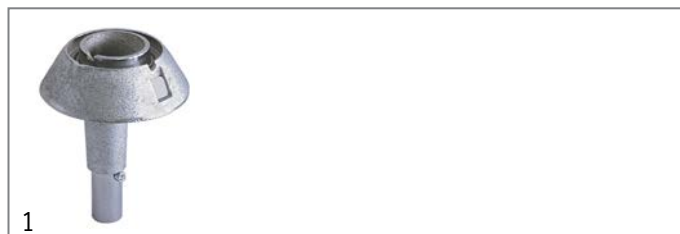

<b>Part No.</b>	105096	<b>Ref. No.</b>	31807200
<b>description</b>	burner head 3.5kW for burner cap ø 80mm		
<b>For models:</b>	G12F4H9+FGP, G12F4H9M, G6F2B, G6F2B+A2, G6F2BH6, G6F2BH9, G6F2H6+FE1, G6F2H6+FG1, G6F2H9+FE1, G6F2H9+FG1, G6F2H9+T, G6F2H9+TE, G6F2MH6, G6F2MH9, G6F2P9+TE, G6F3BH9, G6F3H9+T, G6F4B, G6F4B+A4, G6F6B, G6F6B+A6, G7F2B, G7F2M, G7F4+FE, G7F4+FE1, G7F4+FES, G7F4+FG, G7F4+FG1, G7F4B, G7F4M, G7F6+FE, G7F6+FE1, G7F6+FES, G7F6+FG, G7F6+FG1, G7F6+T, G7F6B, G7F6M, G7T4P2F+FG1, G7T4P2FB, G7T4P2FM, G7T4P4F+FG, G7T4P4F+FG1, G7T4P4FB, G7T4P4FM, G7TP2F+FG, G7TP2F+FG1, G7TP2F+T, G7TP2FM, G9F2M...(Other models you can see in the webshop)		

accessories for	105096		
-----------------	--------	--	--

	<b>Part No.</b>	105094	Ref. No. 31913600
	burner holder 3.5/6kW for burner cap ø 80/110mm		

	<b>Part No.</b>	105096	Ref. No. 31807200
	burner head 3.5kW for burner cap ø 80mm		

	<b>Part No.</b>	105097	Ref. No. 32327600
	nozzle holder nozzle mounting M10x1 tube ø 10mm gas inlet M16x1.5 gas outlet M14x1		

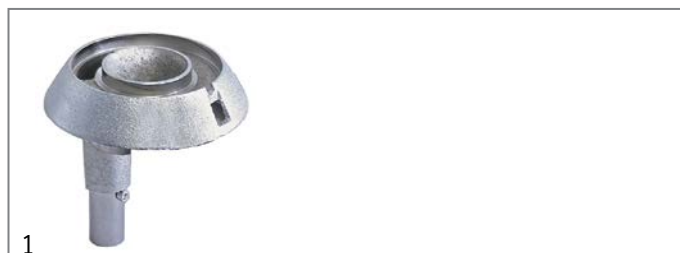

<b>Part No.</b>	105093	<b>Ref. No.</b>	31807000
<b>description</b>	burner head 6kW for burner cap ø 110mm		
<b>For models:</b>	G12F4H9+FGP, G12F4H9M, G6F2B, G6F2B+A2, G6F2BH6, G6F2BP6, G6F2H6+FE1, G6F2H6+FG1, G6F2MH6, G6F2MP6, G6F2P6+FE1, G6F2P6+FG1, G6F3BH12, G6F3BH9, G6F3H12+FE1, G6F3H12+FG1, G6F3H12+T, G6F3H12+TE, G6F3H9+T, G6F3MH12, G6F4B, G6F4B+A4, G6F6B, G6F6B+A6, G7F2B, G7F2BP, G7F2M, G7F2MP, G7F4+FE, G7F4+FE1, G7F4+FES, G7F4+FG, G7F4+FG1, G7F4B, G7F4BP, G7F4M, G7F4MP, G7F4P+FG, G7F4P+FG+AF2, G7F4P+FG1, G7F4P+FG1+AF1, G7F6+FE, G7F6+FE1, G7F6+FES, G7F6+FG, G7F6+FG1, G7F6+T, G7F6B, G7F6BP, G7F6M...(Other models you can see in the webshop)		

accessories for	105093		
-----------------	--------	--	--

	<b>Part No.</b>	105092	Ref. No. 31954300
	burner cap with central hole ø 110mm 6kW		

	<b>Part No.</b>	105093	Ref. No. 31807000
	burner head 6kW for burner cap ø 110mm		





	<b>Part No.</b>	105097	Ref. No. 32327600
	nozzle holder nozzle mounting M10x1 tube ø 10mm gas inlet M16x1.5 gas outlet M14x1		





1 gas components





			
<b>1</b>			
<b>Part No.</b>	105725	<b>Ref. No.</b>	35807000
<b>description</b>	burner head 9kW for burner cap ø 130mm		
<b>For models:</b>	G12F4H9+FGP, G12F4H9M, G12F4P9+FGP, G12F4P9M, G6F2BH9, G6F2BP9, G6F2H9+FE1, G6F2H9+FG1, G6F2H9+T, G6F2H9+TE, G6F-2MH9, G6F2MP9, G6F2P9+FE1, G6F2P9+FG1, G6F2P9+T, G6F2P9+TE, G6F3BH12, G6F3BH9, G6F3H12+FE1, G6F3H12+FG1, G6F3H12+T, G6F3H12+TE, G6F3H9+T, G6F3MH12, G9F2M, G9F2MP, G9F4+FE, G9F4+FE1, G9F4+FG, G9F4+FG1, G9F4M, G9F4MP, G9F4P+FG, G9F4P+FG+AF2, G9F4P+FG1, G9F4P+FG1+AF1, G9F6+FE, G9F6+FE1, G9F6+FG, G9F6+FG1, G9F6+T, G9F6M, G9F6MP, G9F6P+FG, G9F6P+FG+AF2, G9F6P+FG1, G9F6P+T, G9F6P+T+AF2, G9F8+2FE, G9F8+-2FE1...(Other models you can see in the webshop)		
<b>accessories for</b>	105725		
	<b>Part No.</b>	105097	<b>Ref. No.</b> 32327600
	nozzle holder nozzle mounting M10x1 tube ø 10mm gas inlet M16x1.5 gas outlet M14x1		
	<b>Part No.</b>	105724	<b>Ref. No.</b> 35974400
	pilot burner bracket		
	<b>Part No.</b>	105726	<b>Ref. No.</b> 35954300
	burner cap with central hole ø 130mm 9kW		

			
<b>1</b>			
<b>Part No.</b>	105094	<b>Ref. No.</b>	31913600
<b>description</b>	burner holder 3.5/6kW for burner cap ø 80/110mm		
<b>For models:</b>	G12F4H9+FGP, G12F4H9M, G6F2B, G6F2B+A2, G6F2BH6, G6F2BH9, G6F2BP6, G6F2H6+FE1, G6F2H6+FG1, G6F2H9+FE1, G6F2H9+FG1, G6F2H9+T, G6F2H9+TE, G6F2MH6, G6F2MH9, G6F2MP6, G6F2P6+FE1, G6F2P6+FG1, G6F2P9+FG1, G6F2P9+T, G6F2P9+TE, G6F3BH12, G6F3BH9, G6F3H12+FE1, G6F3H12+FG1, G6F3H12+T, G6F3H12+TE, G6F3H9+T, G6F3MH12, G6F4B, G6F4B+A4, G6F6B, G6F6B+A6, G7F2B, G7F2BP, G7F2M, G7F2MP, G7F4+FE, G7F4+FE1, G7F4+FES, G7F4+FG, G7F4+FG1, G7F4B, G7F4BP, G7F4E+FG, G7F4E+FG+A4, G7F4M, G7F4MP, G7F4P+FG, G7F4P+FG+AF2...(Other models you can see in the webshop)		
<b>accessories for</b>	105094		
	<b>Part No.</b>	105095	<b>Ref. No.</b> 31954400
	burner cap ø 80mm 3.5kW		
	<b>Part No.</b>	105096	<b>Ref. No.</b> 31807200
	burner head 3.5kW for burner cap ø 80mm		
	<b>Part No.</b>	105097	<b>Ref. No.</b> 32327600
	nozzle holder nozzle mounting M10x1 tube ø 10mm gas inlet M16x1.5 gas outlet M14x1		

			
<b>1</b>			
<b>Part No.</b>	105716	<b>Ref. No.</b>	35913600
<b>description</b>	burner holder 9kW for burner cap ø 130mm		
<b>For models:</b>	G12F4H9+FGP, G12F4H9M, G12F4P9+FGP, G12F4P9M, G6F2H9+FE1, G6F2H9+FG1, G6F2H9+T, G6F2H9+TE, G6F2P9+FE1, G6F2P9+FG1, G6F2P9+T, G6F2P9+TE, G6F3BH12, G6F3BH9, G6F3H12+FE1, G6F3H12+FG1, G6F3H12+T, G6F3H12+TE, G6F3H9+T, G6F3MH12, G9F2M, G9F2MP, G9F4+FE, G9F4+FE1, G9F4+FG, G9F4+FG1, G9F4M, G9F4MP, G9F4P+FG, G9F4P+FG+AF2, G9F4P+FG1, G9F4P+FG1+AF1, G9F6+FE, G9F6+FE1, G9F6+FG, G9F6+FG1, G9F6+T, G9F6M, G9F6MP, G9F6P+FG, G9F6P+FG+AF2, G9F6P+FG1, G9F6P+T, G9F6P+T+AF2, G9F8+2FE, G9F8+2FE1, G9F8+2FG, G9F8+2FG1, G9F8P+2FG, G9F-8P+2FG+AF2...(Other models you can see in the webshop)		
<b>accessories for</b>	105716		
	<b>Part No.</b>	105092	<b>Ref. No.</b> 31954300
	burner cap with central hole ø 110mm 6kW		
	<b>Part No.</b>	105093	<b>Ref. No.</b> 31807000
	burner head 6kW for burner cap ø 110mm		
	<b>Part No.</b>	105097	<b>Ref. No.</b> 32327600
	nozzle holder nozzle mounting M10x1 tube ø 10mm gas inlet M16x1.5 gas outlet M14x1		
	<b>Part No.</b>	105725	<b>Ref. No.</b> 35807000
	burner head 9kW for burner cap ø 130mm		













			
<b>1</b>			
<b>Part No.</b>	106918	<b>Ref. No.</b>	31912400
<b>description</b>	burner holder ø 30mm D for burner cap ø 110mm		
<b>For models:</b>	CPG40, CPG40E, CPG80, CPG80E, E9F15-4M, E9F15-8M, E9F18-4M, E9F18-8M, G6CP6, G6F2B, G6F2B+A2, G6F2BH6, G6F2BH9, G6F2BP6, G6F2BP9, G6F2H6+FE1, G6F2H6+FG1, G6F2H9+FE1, G6F2H9+FG1, G6F2H9+T, G6F2H9+TE, G6F2MH6, G6F2MH9, G6F2MP6, G6F2MP9, G6F2P6+FE1, G6F2P6+FG1, G6F2P9+FE1, G6F2P9+FG1, G6F2P9+T, G6F2P9+TE, G6F3BH12, G6F3H12+FE1, G6F3H12+FG1, G6F3H12+T, G6F3H12+TE, G6F3MH12, G6F4B, G6F4B+A4, G6F6B, G6F6B+A6, G6FL3B, G6FL3B-CR, G6FL3B-SX, G6FL3M, G6FL3M-CR, G6FL3M-SX, G6FL6B, G6FL6B-CR, G6FL6B-SX...(Other models you can see in the webshop)		
<b>accessories for</b>	105097		
	<b>Part No.</b>	105094	<b>Ref. No.</b> 31913600
	burner holder 3.5/6kW for burner cap ø 80/110mm		
	<b>Part No.</b>	105724	<b>Ref. No.</b> 35974400
	pilot burner bracket		

Table continues overleaf







accessories for	105097		
	<b>Part No.</b>	107691	Ref. No. 35912600
	burner holder D/E ø 33mm for burner cap ø 130/140mm		
	<b>Part No.</b>	107934	Ref. No. 32811500
	nut H 5mm thread M14x1 WS 17		





Modulare Systeme (1) series			
	1		
<b>Part No.</b>	103068	<b>Ref. No.</b>	22294500
<b>description</b>	burner cap ø 100mm		
<b>For models:</b>	G2FS4, G4F+FCD8, G4F+FSD8, G4FD8		
accessories for	103068		
	<b>Part No.</b>	103067	Ref. No. 22285300
	burner ring for burner cap ø 100mm		
	<b>Part No.</b>	104102	Ref. No. 22283200
	burner head for burner cap ø 100mm ext. ø 130		
	<b>Part No.</b>	104103	Ref. No. 22993100
	burner holder suitable for burner ø100mm with nozzle holder		

	1		
<b>Part No.</b>	103066	<b>Ref. No.</b>	22294100
<b>description</b>	burner cap ø 80mm		
<b>For models:</b>	G2FS4, G4F+FCD8, G4F+FSD8, G4FD8		
accessories for	103066		
	<b>Part No.</b>	103065	Ref. No. 22284800
	burner ring for burner cap ø 80mm		
	<b>Part No.</b>	104100	Ref. No. 22282700
	burner head for burner cap ø 80mm		
	<b>Part No.</b>	104101	Ref. No. 22992900
	burner holder for burner cap ø 80mm with nozzle holder with mixing sleeve		





	1		
<b>Part No.</b>	104102	<b>Ref. No.</b>	22283200
<b>description</b>	burner head for burner cap ø 100mm ext. ø 130		
<b>For models:</b>	G2FS4, G4F+FCD8, G4F+FSD8, G4FD8		





	1		
<b>Part No.</b>	104100	<b>Ref. No.</b>	22282700
<b>description</b>	burner head for burner cap ø 80mm		
<b>For models:</b>	G2FS4, G4F+FCD8, G4F+FSD8, G4FD8		
accessories for	104100		
	<b>Part No.</b>	103065	Ref. No. 22284800
	burner ring for burner cap ø 80mm		
	<b>Part No.</b>	103066	Ref. No. 22294100
	burner cap ø 80mm		
	<b>Part No.</b>	104103	Ref. No. 22993100
	burner holder suitable for burner ø100mm with nozzle holder		

	1		
<b>Part No.</b>	104101	<b>Ref. No.</b>	22992900
<b>description</b>	burner holder for burner cap ø 80mm with nozzle holder with mixing sleeve		
<b>For models:</b>	G4F+FCD8, G4F+FSD8		
accessories for	104101		
	<b>Part No.</b>	103065	Ref. No. 22284800
	burner ring for burner cap ø 80mm		
	<b>Part No.</b>	103066	Ref. No. 22294100
	burner cap ø 80mm		
	<b>Part No.</b>	104100	Ref. No. 22282700
	burner head for burner cap ø 80mm		



	1		
<b>Part No.</b>	104103	<b>Ref. No.</b>	22993100
<b>description</b>	burner holder suitable for burner ø100mm with nozzle holder		
<b>For models:</b>	G4F+FCD8, G4F+FSD8		
accessories for	104103		
	<b>Part No.</b>	103067	Ref. No. 22285300
	burner ring for burner cap ø 100mm		
	<b>Part No.</b>	103068	Ref. No. 22294500
	burner cap ø 100mm		
	<b>Part No.</b>	104102	Ref. No. 22283200
	burner head for burner cap ø 100mm ext. ø 130		











			
1			
<b>Part No.</b>	103067	<b>Ref. No.</b>	22285300
<b>description</b>	burner ring for burner cap ø 100mm		
<b>For models:</b>	G2FS4, G4F+FCD8, G4F+FSD8, G4FD8		
<b>accessories for</b>	103067		
	<b>Part No.</b>	103068	Ref. No. 22294500
	burner cap ø 100mm		
	<b>Part No.</b>	104102	Ref. No. 22283200
	burner head for burner cap ø 100mm ext. ø 130		
	<b>Part No.</b>	104103	Ref. No. 22993100
	burner holder suitable for burner ø100mm with nozzle holder		

			
1			
<b>Part No.</b>	103065	<b>Ref. No.</b>	22284800
<b>description</b>	burner ring for burner cap ø 80mm		
<b>For models:</b>	G2FS4, G4F+FCD8, G4F+FSD8, G4FD8		
<b>accessories for</b>	103065		
	<b>Part No.</b>	103066	Ref. No. 22294100
	burner cap ø 80mm		
	<b>Part No.</b>	104100	Ref. No. 22282700
	burner head for burner cap ø 80mm		
	<b>Part No.</b>	104101	Ref. No. 22992900
	burner holder for burner cap ø 80mm with nozzle holder with mixing sleeve		

Modulare Systeme (2) series			
			
1			
<b>Part No.</b>	103069	<b>Ref. No.</b>	22293700
<b>description</b>	burner cap ø 80mm 4.3kW with central hole		
<b>For models:</b>	G2FS4-S, G4FD8-S, G4S+FCGN, G4S+FSGN, G6F12-S, G6S+FCGN, G6S+FSGN		
<b>accessories for</b>	103069		
	<b>Part No.</b>	100907	Ref. No. —
	screw connection thread M10x1 Qty 1 pcs type SEF 1 ømm for thermocouple		
	<b>Part No.</b>	101452	Ref. No. —
	ignition electrode support for burner type C/D suitable for 900 series		
	<b>Part No.</b>	101453	Ref. No. —
	bracket for thermocouple gas range for burner type C/D suitable for 900 series		
	<b>Part No.</b>	101454	Ref. No. —
	union screw for igniter thread M10x1 ID ø 7mm L 15mm		
	<b>Part No.</b>	104104	Ref. No. 22280300
	burner head for burner cap ø 80mm 3.5kW code 100212		

<b>accessories for</b>	103069		
	<b>Part No.</b>	104105	Ref. No. 22993300
	burner lower part for burner cap ø 80mm 3.5kW		
	<b>Part No.</b>	104108	Ref. No. 22913400
	nozzle holder nozzle mounting M10x1 tube ø 10mm gas inlet M16x1.5 gas outlet M14x1		
	<b>Part No.</b>	105297	Ref. No. —
	burner head for burner cap ø 80mm 4.3kW for pilot burner		

			
1			
<b>Part No.</b>	103070	<b>Ref. No.</b>	22293900
<b>description</b>	burner cap ø 95mm 6.4kW with central hole		
<b>For models:</b>	G2FS4-S, G4FD8-S, G4S+FCGN, G4S+FSGN, G6F12-S, G6S+FCGN, G6S+FSGN		
<b>accessories for</b>	103070		
	<b>Part No.</b>	100907	Ref. No. —
	screw connection thread M10x1 Qty 1 pcs type SEF 1 ømm for thermocouple		
	<b>Part No.</b>	101452	Ref. No. —
	ignition electrode support for burner type C/D suitable for 900 series		
	<b>Part No.</b>	101453	Ref. No. —
	bracket for thermocouple gas range for burner type C/D suitable for 900 series		
	<b>Part No.</b>	101454	Ref. No. —
	union screw for igniter thread M10x1 ID ø 7mm L 15mm		
	<b>Part No.</b>	104106	Ref. No. 22280400
	burner head for burner cap ø 100mm 5.5kW for igniter		
	<b>Part No.</b>	104107	Ref. No. 22993400
	burner lower part for burner cap ø 100mm 6.4kW		
	<b>Part No.</b>	104108	Ref. No. 22913400
	nozzle holder nozzle mounting M10x1 tube ø 10mm gas inlet M16x1.5 gas outlet M14x1		



















			
1			
<b>Part No.</b>	104106	<b>Ref. No.</b>	22280400
<b>description</b>	burner head for burner cap ø 100mm 5.5kW for igniter		
<b>For models:</b>	G2FS4-S, G4FD8-S, G4S+FCGN, G4S+FSGN, G6F12-S, G6S+FCGN, G6S+FSGN		
<b>accessories for</b>	104106		
	<b>Part No.</b>	100907	Ref. No. —
	screw connection thread M10x1 Qty 1 pcs type SEF 1 ømm for thermocouple		
	<b>Part No.</b>	101452	Ref. No. —
	ignition electrode support for burner type C/D suitable for 900 series		
	<b>Part No.</b>	101453	Ref. No. —
	bracket for thermocouple gas range for burner type C/D suitable for 900 series		





Table continues overleaf



accessories for		104106	
	<b>Part No.</b>	101454	Ref. No. —
union screw for igniter thread M10x1 ID ø 7mm L 15mm			
	<b>Part No.</b>	103070	Ref. No. 22293900
burner cap ø 95mm 6.4kW with central hole			
	<b>Part No.</b>	104107	Ref. No. 22993400
burner lower part for burner cap ø 100mm 6.4kW			
	<b>Part No.</b>	104108	Ref. No. 22913400
nozzle holder nozzle mounting M10x1 tube ø 10mm gas inlet M16x1.5 gas outlet M14x1			





1 			
<b>Part No.</b>	104104	<b>Ref. No.</b>	22280300
<b>description</b> burner head for burner cap ø 80mm 3.5kW code 100212			
<b>For models:</b> G2FS4-S, G4FD8-S, G4S+FCGN, G4S+FSGN, G6F12-S, G6S+FCGN, G6S+FSGN			
accessories for		104104	
	<b>Part No.</b>	100907	Ref. No. —
screw connection thread M10x1 Qty 1 pcs type SEF 1 ømm for thermocouple			
	<b>Part No.</b>	101452	Ref. No. —
ignition electrode support for burner type C/D suitable for 900 series			
	<b>Part No.</b>	101453	Ref. No. —
bracket for thermocouple gas range for burner type C/D suitable for 900 series			
	<b>Part No.</b>	101454	Ref. No. —
union screw for igniter thread M10x1 ID ø 7mm L 15mm			
	<b>Part No.</b>	103069	Ref. No. 22293700
burner cap ø 80mm 4.3kW with central hole			
	<b>Part No.</b>	104105	Ref. No. 22993300
burner lower part for burner cap ø 80mm 3.5kW			
	<b>Part No.</b>	104108	Ref. No. 22913400
nozzle holder nozzle mounting M10x1 tube ø 10mm gas inlet M16x1.5 gas outlet M14x1			

1 			
<b>Part No.</b>	104107	<b>Ref. No.</b>	22993400
<b>description</b> burner lower part for burner cap ø 100mm 6.4kW			
<b>For models:</b> G2FS4-S, G4FD8-S, G4S+FCGN, G4S+FSGN, G6F12-S, G6S+FCGN, G6S+FSGN			
accessories for		104107	
	<b>Part No.</b>	100907	Ref. No. —
screw connection thread M10x1 Qty 1 pcs type SEF 1 ømm for thermocouple			
	<b>Part No.</b>	101452	Ref. No. —
ignition electrode support for burner type C/D suitable for 900 series			

accessories for		104107	
	<b>Part No.</b>	101453	Ref. No. —
bracket for thermocouple gas range for burner type C/D suitable for 900 series			
	<b>Part No.</b>	101454	Ref. No. —
union screw for igniter thread M10x1 ID ø 7mm L 15mm			
	<b>Part No.</b>	103070	Ref. No. 22293900
burner cap ø 95mm 6.4kW with central hole			
	<b>Part No.</b>	104106	Ref. No. 22280400
burner head for burner cap ø 100mm 5.5kW for igniter			
	<b>Part No.</b>	104108	Ref. No. 22913400
nozzle holder nozzle mounting M10x1 tube ø 10mm gas inlet M16x1.5 gas outlet M14x1			



1 			
<b>Part No.</b>	104105	<b>Ref. No.</b>	22993300
<b>description</b> burner lower part for burner cap ø 80mm 3.5kW			
<b>For models:</b> G2FS4-S, G4FD8-S, G4S+FCGN, G4S+FSGN, G6F12-S, G6S+FCGN, G6S+FSGN			
accessories for		104105	
	<b>Part No.</b>	100907	Ref. No. —
screw connection thread M10x1 Qty 1 pcs type SEF 1 ømm for thermocouple			
	<b>Part No.</b>	101452	Ref. No. —
ignition electrode support for burner type C/D suitable for 900 series			
	<b>Part No.</b>	101453	Ref. No. —
bracket for thermocouple gas range for burner type C/D suitable for 900 series			
	<b>Part No.</b>	101454	Ref. No. —
union screw for igniter thread M10x1 ID ø 7mm L 15mm			
	<b>Part No.</b>	103069	Ref. No. 22293700
burner cap ø 80mm 4.3kW with central hole			
	<b>Part No.</b>	104104	Ref. No. 22280300
burner head for burner cap ø 80mm 3.5kW code 100212			
	<b>Part No.</b>	104108	Ref. No. 22913400
nozzle holder nozzle mounting M10x1 tube ø 10mm gas inlet M16x1.5 gas outlet M14x1			
	<b>Part No.</b>	105297	Ref. No. —
burner head for burner cap ø 80mm 4.3kW for pilot burner			





	<b>1</b>	<b>Part No.</b>	104108	<b>Ref. No.</b>	22913400
<b>description</b>		nozzle holder nozzle mounting M10x1 tube $\varnothing$ 10mm gas inlet M16x1.5 gas outlet M14x1			
<b>For models:</b>		G2FS4-S, G4FD8-S, G4S+FCGN, G4S+FSGN, G6F12-S, G6S+FCGN, G6S+FSGN			
<b>accessories for</b>		104108			
	<b>1</b>	<b>Part No.</b>	102382	<b>Ref. No.</b>	—
<b>description</b>		nut thread M14x1 H 3.5mm WS 18 brass Qty 1 pcs			
	<b>1</b>	<b>Part No.</b>	104105	<b>Ref. No.</b>	22993300
<b>description</b>		burner lower part for burner cap $\varnothing$ 80mm 3.5kW			
	<b>1</b>	<b>Part No.</b>	104107	<b>Ref. No.</b>	22993400
<b>description</b>		burner lower part for burner cap $\varnothing$ 100mm 6.4kW			

## S900 series



	<b>1</b>	<b>Part No.</b>	105826	<b>Ref. No.</b>	31954800
<b>description</b>		burner cap C $\varnothing$ 82mm 3.5kW			





	<b>1</b>	<b>Part No.</b>	106713	<b>Ref. No.</b>	35954200
<b>description</b>		burner cap E $\varnothing$ 140mm 12kW			
<b>accessories for</b>		106713			
	<b>1</b>	<b>Part No.</b>	106714	<b>Ref. No.</b>	35806800
<b>description</b>		burner head E $\varnothing$ 130mm for burner cap $\varnothing$ 140mm 12kW			

	<b>1</b>	<b>Part No.</b>	106933	<b>Ref. No.</b>	31954700
<b>description</b>		burner cap $\varnothing$ 110mm 7kW			

	<b>1</b>	<b>Part No.</b>	106827	<b>Ref. No.</b>	31808200
<b>description</b>		burner head C for burner cap $\varnothing$ 82mm 3.5kW			

	<b>1</b>	<b>Part No.</b>	106917	<b>Ref. No.</b>	31807100
<b>description</b>		burner head D $\varnothing$ 140mm for burner cap $\varnothing$ 110mm 7kW			

	<b>1</b>	<b>Part No.</b>	106714	<b>Ref. No.</b>	35806800
<b>description</b>		burner head E $\varnothing$ 130mm for burner cap $\varnothing$ 140mm 12kW			
<b>accessories for</b>		106714			
	<b>1</b>	<b>Part No.</b>	106713	<b>Ref. No.</b>	35954200
<b>description</b>		burner cap E $\varnothing$ 140mm 12kW			

	<b>1</b>	<b>Part No.</b>	105094	<b>Ref. No.</b>	31913600
<b>description</b>		burner holder 3.5/6kW for burner cap $\varnothing$ 80/110mm			
<b>For models:</b>		G12F4H9+FGP, G12F4H9M, G6F2B, G6F2B+A2, G6F2BH6, G6F2BH9, G6F2BP6, G6F2H6+FE1, G6F2H6+FG1, G6F2H9+FE1, G6F2H9+FG1, G6F2H9+T, G6F2H9+TE, G6F2MH6, G6F2MH9, G6F2MP6, G6F2P6+FE1, G6F2P6+FG1, G6F2P9+FG1, G6F2P9+T, G6F2P9+TE, G6F3BH12, G6F3BH9, G6F3H12+FE1, G6F3H12+FG1, G6F3H12+T, G6F3H12+TE, G6F3H9+T, G6F3MH12, G6F4B, G6F4B+A4, G6F6B, G6F6B+A6, G7F2B, G7F2BP, G7F2M, G7F2MP, G7F4+FE, G7F4+FE1, G7F4+FES, G7F4+FG, G7F4+FG1, G7F4B, G7F4BP, G7F4E+FG, G7F4E+FG+A4, G7F4M, G7F4MP, G7F4P+FG, G7F4P+FG+AF2...(Other models you can see in the webshop)			
<b>accessories for</b>		105094			
	<b>1</b>	<b>Part No.</b>	105095	<b>Ref. No.</b>	31954400
<b>description</b>		burner cap $\varnothing$ 80mm 3.5kW			
	<b>1</b>	<b>Part No.</b>	105096	<b>Ref. No.</b>	31807200
<b>description</b>		burner head 3.5kW for burner cap $\varnothing$ 80mm			
	<b>1</b>	<b>Part No.</b>	105097	<b>Ref. No.</b>	32327600
<b>description</b>		nozzle holder nozzle mounting M10x1 tube $\varnothing$ 10mm gas inlet M16x1.5 gas outlet M14x1			



			
1			
<b>Part No.</b>	107691	<b>Ref. No.</b>	35912600
<b>description</b>	burner holder D/E ø 33mm for burner cap ø 130/140mm		

			
1			
<b>Part No.</b>	106918	<b>Ref. No.</b>	31912400
<b>description</b>	burner holder ø 30mm D for burner cap ø 110mm		

pan supports

			
1			
<b>Part No.</b>	210142	<b>Ref. No.</b>	31856500
<b>description</b>	pan support		
<b>For models:</b>	G6F2B, G6F2B+A2, G6F4B, G6F4B+A4, G6F6B, G6F6B+A6, G7F2B, G7F2M, G7F4+FE, G7F4+FE1, G7F4+FES, G7F4+FG, G7F4+FG1, G7F4B, G7F4M, G7F6+FE, G7F6+FE1, G7F6+FES, G7F6+FG, G7F6+FG1, G7F6B, G7F6M, G7T4P2F+FG1, G7T4P2FB, G7T4P2FM, G7T4P4F+FG, G7T4P4F+FG1, G7T4P4FB, G7T4P4FM, G7TP2F+FG, G7TP2F+FG1, G7TP2F+T, G7TP2FM		

			
1			
<b>Part No.</b>	210061	<b>Ref. No.</b>	35856700 35858700
<b>description</b>	pan support L 380mm W 380mm 1 flame		
<b>For models:</b>	G9F2ME, G9F2ME+A2, G9F2MPW, G9F2MPW+AE, G9F4E+FE1, G9F4E+FE1+A4, G9F4E+FG1, G9F4E+FG1+A4, G9F4ME, G9F4ME+A4, G9F4MPW, G9F4MPW+AE, G9F4PW+FE, G9F4PW+FE+AE, G9F4PW+FE1, G9F4PW+FE1+AE, G9F4PW+FG, G9F4PW+FG+AE, G9F4PW+FG1, G9F4PW+FG1+AE, G9F6E+FE1, G9F6E+FE1+A6, G9F6E+FG1, G9F6E+FG1+A6, G9F6ME, G9F6ME+A6, G9F6MPW, G9F6MPW+AE, G9F6PW+FE, G9F6PW+FE+AE, G9F6PW+FE1, G9F6PW+FE1+AE, G9F6PW+FG, G9F6PW+FG+AE, G9F6PW+FG1, G9F6PW+FG1+AE, G9F6PW+T, G9F6PW+T+AE		

			
1			
<b>Part No.</b>	210136	<b>Ref. No.</b>	31856600
<b>description</b>	pan support W 340mm L 560mm		
<b>For models:</b>	G7F2BE, G7F2BE+A2, G7F2ME, G7F2ME+A2, G7F4BE, G7F4BE+A4, G7F4E+FE, G7F4E+FE+A4, G7F4E+FE1, G7F4E+FE1+A4, G7F4E+FG, G7F4E+FG+A4, G7F4E+FG1, G7F4E+FG1+A4, G7F4ME, G7F4ME+A4, G7F6BE, G7F6BE+A6, G7F6E+FE, G7F6E+FE+A6, G7F6E+FE1, G7F6E+FE1+A6, G7F6E+FG, G7F6E+FG+A4, G7F6E+FG1, G7F6E+FG1+A4, G7F6E+FG1+A6, G7F6E+T		

			
1			
<b>Part No.</b>	210253	<b>Ref. No.</b>	31856700
<b>description</b>	pan support W 345mm L 560mm		
<b>For models:</b>	G7F2BE, G7F2BE+A2, G7F2BPW, G7F2BPW+AE, G7F2BPW-F, G7F2ME, G7F2ME+A2, G7F2MPW, G7F2MPW+AE, G7F4BE, G7F4BE+A4, G7F4BPW, G7F4BPW+AE, G7F4E+FE, G7F4E+FE+A4, G7F4E+FE1, G7F4E+FE1+A4, G7F4E+FG, G7F4E+FG+A4, G7F4E+FG1, G7F4E+FG1+A4, G7F4ME, G7F4ME+A4, G7F4MPW, G7F4MPW+AE, G7F4PW+FE, G7F4PW+FE+AE, G7F4PW+FE1, G7F4PW+FE1+AE, G7F4PW+FG, G7F4PW+FG+AE, G7F4PW+FG1, G7F4PW+FG1+AE, G7F6BE, G7F6BE+A6, G7F6BPW, G7F6BPW+AE, G7F6E+FE, G7F6E+FE+A6, G7F6E+FE1, G7F6E+FE1+A6, G7F6E+FG, G7F6E+FG+A6, G7F6E+FG1, G7F6E+FG1+A6, G7F6ME, G7F6ME+A6, G7F6MPW, G7F6MPW+AE, G7F6PW+FE...(Other models you can see in the webshop)		

			
1			
<b>Part No.</b>	210252	<b>Ref. No.</b>	31856200
<b>description</b>	pan support W 365mm L 580mm		
<b>For models:</b>	G6F2BH6, G6F2BP6, G6F2H6+FE1, G6F2H6+FG1, G6F2MH6, G6F2MP6, G6F2P6+FE1, G6F2P6+FG1, G7F2BP, G7F2MP, G7F4+FE1, G7F4+FG, G7F4+FG1, G7F4BP, G7F4MP, G7F4P+FG, G7F4P+FG+AF2, G7F4P+FG1, G7F4P+FG1+AF1, G7F6+FE1, G7F6+FG, G7F6+FG1, G7F6+T, G7F6BP, G7F6MP, G7F6P+FG, G7F6P+FG+AF2, G7F6P+FG1, G7F6P+FG1+AF1, G7F6P+T, G7F6P+T+AF2		

1 gas components



			
1			
<b>Part No.</b>	210161	<b>Ref. No.</b>	22642300
<b>description</b>	pan support W 385mm L 580mm		
<b>For models:</b>	G2FS4-S, G4FD8-S, G4S+FCGN, G4S+FSGN, G6F12-S, G6S+FCGN, G6S+FSGN		

			
1			
<b>Part No.</b>	210215	<b>Ref. No.</b>	35856500 35856600 38856700
<b>description</b>	pan support W 390mm L 390mm		
<b>For models:</b>	G12F4H9+FGP, G12F4H9M, G12F4P9+FGP, G12F4P9M, G6F2BH9, G6F2BP9, G6F2H9+FE1, G6F2H9+FG1, G6F2H9+T, G6F2H9+TE, G6F2MH9, G6F2MP9, G6F2P9+FE1, G6F2P9+FG1, G6F2P9+T, G6F2P9+TE, G6F3BH12, G6F3H12+FE1, G6F3H12+FG1, G6F3H12+T, G6F3H12+TE, G6F3MH12, G9F2M, G9F2MP, G9F4+FE, G9F4+FE1, G9F4+FG, G9F4+FG1, G9F4M, G9F4MP, G9F4P+FG, G9F4P+FG+AF2, G9F4P+FG1, G9F4P+FG1+AF1, G9F6+FE, G9F6+FE1, G9F6+FG, G9F6+FG1, G9F6+T, G9F6M, G9F6MP, G9F6P+FG, G9F6P+FG+AF2, G9F6P+FG1, G9F6P+T, G9F6P+T+AF2, G9F8+2FE, G9F8+2FE1, G9F8+2FG, G9F8+2FG1...(Other models you can see in the webshop)		

## accessories

## pan supports

			
1			
<b>Part No.</b>	210142	<b>Ref. No.</b>	31856500
<b>description</b>	pan support		
<b>For models:</b>	G6F2B, G6F2B+A2, G6F4B, G6F4B+A4, G6F6B, G6F6B+A6, G7F2B, G7F2M, G7F4+FE, G7F4+FE1, G7F4+FES, G7F4+FG, G7F4+FG1, G7F4B, G7F4M, G7F6+FE, G7F6+FE1, G7F6+FES, G7F6+FG, G7F6+FG1, G7F6B, G7F6M, G7T4P2F+FG1, G7T4P2FB, G7T4P2FM, G7T4P4F+FG, G7T4P4F+FG1, G7T4P4FB, G7T4P4FM, G7TP2F+FG, G7TP2F+FG1, G7TP2F+T, G7TP2FM		

			
1			
<b>Part No.</b>	210136	<b>Ref. No.</b>	31856600
<b>description</b>	pan support W 340mm L 560mm		
<b>For models:</b>	G7F2BE, G7F2BE+A2, G7F2ME, G7F2ME+A2, G7F4BE, G7F4BE+A4, G7F4E+FE, G7F4E+FE+A4, G7F4E+FE1, G7F4E+FE1+A4, G7F4E+FG, G7F4E+FG+A4, G7F4E+FG1, G7F4E+FG1+A4, G7F4ME, G7F4ME+A4, G7F6BE, G7F6BE+A6, G7F6E+FE, G7F6E+FE+A6, G7F6E+FE1, G7F6E+FE1+A6, G7F6E+FG, G7F6E+FG+A4, G7F6E+FG1, G7F6E+FG1+A4, G7F6E+FG1+A6, G7F6E+T		

			
1			
<b>Part No.</b>	210253	<b>Ref. No.</b>	31856700
<b>description</b>	pan support W 345mm L 560mm		
<b>For models:</b>	G7F2BE, G7F2BE+A2, G7F2BPW, G7F2BPW+AE, G7F2BPW-F, G7F2ME, G7F2ME+A2, G7F2MPW, G7F2MPW+AE, G7F4BE, G7F4BE+A4, G7F4BPW, G7F4BPW+AE, G7F4E+FE, G7F4E+FE+A4, G7F4E+FE1, G7F4E+FE1+A4, G7F4E+FG, G7F4E+FG+A4, G7F4E+FG1, G7F4E+FG1+A4, G7F4ME, G7F4ME+A4, G7F4MPW, G7F4MPW+AE, G7F4PW+FE, G7F4PW+FE+AE, G7F4PW+FE1, G7F4PW+FE1+AE, G7F4PW+FG, G7F4PW+FG+AE, G7F4PW+FG1, G7F4PW+FG1+AE, G7F6BE, G7F6BE+A6, G7F6BPW, G7F6BPW+AE, G7F6E+FE, G7F6E+FE+A6, G7F6E+FE1, G7F6E+FE1+A6, G7F6E+FG, G7F6E+FG+A6, G7F6E+FG1, G7F6E+FG1+A6, G7F6ME, G7F6ME+A6, G7F6MPW, G7F6MPW+AE, G7F6PW+FE...(Other models you can see in the webshop)		

			
1			
<b>Part No.</b>	210263	<b>Ref. No.</b>	31858100
<b>description</b>	pan support W 360mm L 578mm		

1

<b>Part No.</b>	210252	<b>Ref. No.</b>	31856200
<b>description</b>	pan support W 365mm L 580mm		
<b>For models:</b>	G6F2BH6, G6F2BP6, G6F2H6+FE1, G6F2H6+FG1, G6F2MH6, G6F2MP6, G6F2P6+FE1, G6F2P6+FG1, G7F2BP, G7F2MP, G7F4+FE1, G7F4+FG, G7F4+FG1, G7F4BP, G7F4MP, G7F4P+FG, G7F4P+FG+AF2, G7F4P+FG1, G7F4P+FG1+AF1, G7F6+FE1, G7F6+FG, G7F6+FG1, G7F6+T, G7F6BP, G7F6MP, G7F6P+FG, G7F6P+FG+AF2, G7F6P+FG1, G7F6P+FG1+AF1, G7F6P+T, G7F6P+T+AF2		



1

<b>Part No.</b>	210161	<b>Ref. No.</b>	22642300
<b>description</b>	pan support W 385mm L 580mm		
<b>For models:</b>	G2FS4-S, G4FD8-S, G4S+FCGN, G4S+FSGN, G6F12-S, G6S+FCGN, G6S+FSGN		



1

<b>Part No.</b>	210215	<b>Ref. No.</b>	35856500 35856600 38856700
<b>description</b>	pan support W 390mm L 390mm		
<b>For models:</b>	G12F4H9+FGP, G12F4H9M, G12F4P9+FGP, G12F4P9M, G6F2BH9, G6F2BP9, G6F2H9+FE1, G6F2H9+FG1, G6F2H9+T, G6F2H9+TE, G6F2MH9, G6F2MP9, G6F2P9+FE1, G6F2P9+FG1, G6F2P9+T, G6F2P9+TE, G6F3BH12, G6F3H12+FE1, G6F3H12+FG1, G6F3H12+T, G6F3H12+TE, G6F3MH12, G9F2M, G9F2MP, G9F4+FE, G9F4+FE1, G9F4+FG, G9F4+FG1, G9F4M, G9F4MP, G9F4P+FG, G9F4P+FG+AF2, G9F4P+FG1, G9F4P+FG1+AF1, G9F6+FE, G9F6+FE1, G9F6+FG, G9F6+FG1, G9F6+T, G9F6M, G9F6MP, G9F6P+FG, G9F6P+FG+AF2, G9F6P+FG1, G9F6P+T, G9F6P+T+AF2, G9F8+2FE, G9F8+2FE1, G9F8+2FG, G9F8+2FG1...(Other models you can see in the webshop)		

bar burners

bar burners



1

<b>Part No.</b>	105102	<b>Ref. No.</b>	22275300
<b>description</b>	bar burner 1-row ø 27mm Wmm Hmm L 418mm oven		
<b>For models:</b>	G4F+FSD8		
<b>spare parts for</b>	105102		
	<b>Part No.</b>	104651	<b>Ref. No.</b>
			—
	mounting flange for igniter and thermocouple		



1

<b>Part No.</b>	105788	<b>Ref. No.</b>	25277500
<b>description</b>	bar burner 1-row ø 50mm Wmm Hmm L 483mm flange width 71mm convection oven flange ø 75mm		
<b>For models:</b>	FMG10, FMG10EP, FMG10M, FPG12, MM10GA, MM10GB, WAV-G12, WAV-G20		



1

<b>Part No.</b>	105202	<b>Ref. No.</b>	31278400
<b>description</b>	bar burner 2 row L 430mm W 200mm ømm H 45mm chargrill		
<b>For models:</b>	PLG40B, PLG40BE, PLG40M, PLG40ME, PLG80B, PLG80BE, PLG80M, PLG80ME		



1

<b>Part No.</b>	105260	<b>Ref. No.</b>	22276300
<b>description</b>	bar burner 2 row L 450mm W 300mm ømm H 50mm 8.5kW griddle		
<b>For models:</b>	GFLM6, GFLM6-CR, GFRM6		







			
1			
<b>Part No.</b>	105719	<b>Ref. No.</b>	35278400
<b>description</b>	bar burner 2 row L 600mm W 200mm ømm chargrill		
<b>For models:</b>	G9PL40B, G9PL40M, G9PL80B, G9PL80M, SG9PL40M, SG9PL80M		

			
1			
<b>Part No.</b>	105727	<b>Ref. No.</b>	31781300 31782500
<b>description</b>	bar burner angled ømm W 240mm Hmm L 560mm oven		
<b>For models:</b>	G6F2B, G6F2B+A2, G6F4B, G6F4B+A4, G6F6B, G6F6B+A6, G7F4+FG, G7F4P+FG, G7F4P+FG+AF2, G7F4PW+FG, G7F4PW+FG+AE, G7F6+FG, G7F6P+FG, G7F6P+FG+AF2, G7F6PW+FG, G7F6PW+FG+AE, G7T4P4F+FG, G7TP+FG, G7TP2F+FG, G9F4+FG, G9F4P+FG, G9F4P+FG+AF2, G9F4PW+FG, G9F4PW+FG+AE, G9F6+FG, G9F6P+FG, G9F6P+FG+AF2, G9F6PW+FG, G9F6PW+FG+AE, G9F8+2FG, G9F8P+2FG, G9F8P+2FG+AF2, G9TP+FG, G9TP2F+FG, G9TP4F+FG, SG9F4+FG, SG9F6+FG, SG9F6P+FG, SG9F8+2FG, SG9F8P+2FG, SG9TP+FG, SG9TP2F+FG, SG9TP4F+FG		

			
1			
<b>Part No.</b>	105103	<b>Ref. No.</b>	22275500
<b>description</b>	bar burner ø 27mm Wmm Hmm L 638mm oven		
<b>For models:</b>	G4S+FSGN, G6S+FSGN, G7F4+FG1, G7F4E+FG1, G7F4E+FG1+A4, G7F4P+FG1, G7F4P+FG1+AF1, G7F4PW+FG1, G7F4PW+FG1+AE, G7F6+FG1, G7F6E+FG1, G7F6E+FG1+A4, G7F6E+FG1+A6, G7F6P+FG1, G7F6P+FG1+AF1, G7F6PW+FG1, G7F6PW+FG1+AE, G7T4P2F+FG1, G7T4P4F+FG1, G7TP+FG1, G7TP2F+FG1, G9F4+FG1, G9F4E+FG1, G9F4E+FG1+A4, G9F4P+FG1, G9F4P+FG1+AF1, G9F4PW+FG1, G9F4PW+FG1+AE, G9F6+FG1, G9F6E+FG1, G9F6E+FG1+A6, G9F6P+FG1, G9F6PW+FG1, G9F6PW+FG1+AE, G9F8+2FG1, G9F8P+2FG1, G9TP+FG1, G9TP2F+FG1		
<b>spare parts for</b>	105103		
	<b>Part No.</b>	104651	<b>Ref. No.</b> —
	mounting flange for igniter and thermocouple		
<b>accessories for</b>	105103		
	<b>Part No.</b>	104651	<b>Ref. No.</b> —
	mounting flange for igniter and thermocouple		

			
1			
<b>Part No.</b>	105718	<b>Ref. No.</b>	35277500
<b>description</b>	bar burner ø 40mm Wmm Hmm L 395mm flange ø 61mm tilting bratt pan		
<b>For models:</b>	G9BR8, G9BR8-I, G9P10D, G9P10DA, G9P10I, G9P10IA, G9P15D, G9P15DA, G9P15I, G9P15IA, SG9BR8, SG9BR8-I, SG9P10D, SG9P10DA, SG9P10I, SG9P10IA, SG9P15D, SG9P15DA, SG9P15I		

			
1			
<b>Part No.</b>	105787	<b>Ref. No.</b>	23277000
<b>description</b>	bar burner ø 40mm Wmm Hmm L 415mm flange width 43mm flange length 43mm convection oven		

			
1			
<b>Part No.</b>	105790	<b>Ref. No.</b>	25278700
<b>description</b>	bar burner ø 50mm Wmm Hmm L 322mm flange width 57mm flange length 57mm convection oven		
<b>For models:</b>	FMG10, FMG10EP, FMG10M, FMG20, FMG20M, FMG6, FMG6EP, FMG6M, MM06GA, MM06GB		

			
1			
<b>Part No.</b>	105203	<b>Ref. No.</b>	31279600
<b>description</b>	bar burner ø 50mm Wmm Hmm L 344mm flange width 65mm flange length 71mm tilting bratt pan		
<b>For models:</b>	G7BR8, G7BR8-I		

			
1			
<b>Part No.</b>	105791	<b>Ref. No.</b>	11031
<b>description</b>	bar burner ø 50mm Wmm Hmm L 375mm flange width 57mm flange length 57mm convection oven		





			
1			
<b>Part No.</b>	105681	<b>Ref. No.</b>	35782000
<b>description</b>	bar burner ø 50mm Wmm Hmm L 607mm flange ø 75mm flange width 71mm oven		
<b>For models:</b>	G9FL4M, G9FL4M-CPD, G9FL4M-CR, G9FL4M-SX, G9FL8M-2, G9FL8M-2-CPD, G9FL8M-2-CR, G9FL8M-2-SX, G9FM8M-2, G9FR4M, G9FR8M-2, SG9FL4M, SG9FL4M-CPD, SG9FL4M-CR, SG9FL8M-2, SG9FL8M-2-CPD, SG9FL8M-2-CR, SG9FM8M-2, SG9FM8M-2-CR, SG9FR4M, SG9FR4M-CR, SG9FR8M-2, SG9FR8M-2-CR		

			
1			
<b>Part No.</b>	105789	<b>Ref. No.</b>	1361
<b>description</b>	bar burner ø 50mm Wmm Hmm L 618mm flange width 71mm convection oven flange ø 75mm		

			
1			
<b>Part No.</b>	105204	<b>Ref. No.</b>	31278800
<b>description</b>	bar burner ø 60mm Wmm Hmm L 350mm flange width 67mm flange length 67mm pasta cooker		
<b>For models:</b>	CPG40, CPG40E, CPG80, CPG80E, G6CP6		

			
1			
<b>Part No.</b>	105255	<b>Ref. No.</b>	22275800
<b>description</b>	bar burner ømm W 41mm H 34mm L 490mm flange width 70mm 5.5kW griddle		
<b>For models:</b>	GFLD8, GFLD8-CR, GFLS4, GFLS4-CR, GFRD8, GFRS4		

			
1			
<b>Part No.</b>	107568	<b>Ref. No.</b>	31772000 31782000
<b>description</b>	burner ømm W 45mm H 55mm L 500mm 5kW friddle		
<b>For models:</b>	G7FL4B, G7FL4B-CR, G7FL4B-SX, G7FL4M, G7FL4M-CR, G7FL4M-SX, G7FL8B-2, G7FL8B-2-CR, G7FL8B-2-SX, G7FL8M-2, G7FL8M-2-CR, G7FL8M-2-SX, G7FM8B-2, G7FM8M-2, G7FR4B, G7FR4M, G7FR8B-2, G7FR8M, G7FR8M-2		

			
1			
<b>Part No.</b>	211004	<b>Ref. No.</b>	31972500
<b>description</b>	lava rock grid L 465mm W 325mm		
<b>For models:</b>	PLG40B, PLG40BE, PLG40M, PLG40ME		

			
1			
<b>Part No.</b>	211042	<b>Ref. No.</b>	35972500
<b>description</b>	lava rock grid L 670mm W 330mm		
<b>For models:</b>	G9PL40B, G9PL40M, G9PL80B, G9PL80M, SG9PL40M		

			
1			
<b>Part No.</b>	211005	<b>Ref. No.</b>	31972700
<b>description</b>	lava rock grid L 685mm W 465mm H 37mm		
<b>For models:</b>	PLG80B, PLG80BE, PLG80M, PLG80ME		

			
1			
<b>Part No.</b>	211043	<b>Ref. No.</b>	35972700
<b>description</b>	lava rock grid L 685mm W 670mm		
<b>For models:</b>	G9PL40B, G9PL40M, G9PL80B, G9PL80M, SG9PL80M		

lava rock grids

			
1			
<b>Part No.</b>	211004	<b>Ref. No.</b>	31972500
<b>description</b>	lava rock grid L 465mm W 325mm		
<b>For models:</b>	PLG40B, PLG40BE, PLG40M, PLG40ME		

			
1			
<b>Part No.</b>	211042	<b>Ref. No.</b>	35972500
<b>description</b>	lava rock grid L 670mm W 330mm		
<b>For models:</b>	G9PL40B, G9PL40M, G9PL80B, G9PL80M, SG9PL40M		



			
1			
<b>Part No.</b>	211005	<b>Ref. No.</b>	31972700
<b>description</b>	lava rock grid L 685mm W 465mm H 37mm		
<b>For models:</b>	PLG80B, PLG80BE, PLG80M, PLG80ME		

			
1			
<b>Part No.</b>	211043	<b>Ref. No.</b>	35972700
<b>description</b>	lava rock grid L 685mm W 670mm		
<b>For models:</b>	G9PL40B, G9PL40M, G9PL80B, G9PL80M, SG9PL80M		

## tube burners

			
1			
<b>Part No.</b>	105720	<b>Ref. No.</b>	32279600
<b>description</b>	tubular burner L 275mm W 53mm H 66mm for fryer oval		
<b>For models:</b>	9GL15+15M, 9GL15M, 9GL20+20M, 9GL20M, GL15+15M, GL15M, GL20+20M, GL20M, GL7+7M, S9GL20+20M, S9GL20M, S9GL22M		





			
1			
<b>Part No.</b>	105118	<b>Ref. No.</b>	32279300
<b>description</b>	tubular burner $\varnothing$ 74mm L 180mm H 60mm mounting pos. left round for fryer		
<b>For models:</b>	GL10+10B, GL10+10M, GL10B, GL10M, GL8+8B, GL8+8M, GL8B, GL8M		
<b>accessories for</b>	105118		
	<b>Part No.</b>	100420	Ref. No. 40109500
	gas injector thread M10x1 WS 11 bore $\varnothing$ 0.95mm		
	<b>Part No.</b>	101997	Ref. No. 40114000
	gas injector thread M10x1 WS 11 bore $\varnothing$ 1.4mm		

			
1			
<b>Part No.</b>	105117	<b>Ref. No.</b>	32279200
<b>description</b>	tubular burner $\varnothing$ 74mm L 180mm H 60mm mounting pos. right round for fryer		
<b>For models:</b>	GL10+10B, GL10+10M, GL10B, GL10M, GL30B, GL30M, GL8+8B, GL8+8M, GL8B, GL8M		
<b>accessories for</b>	105117		
	<b>Part No.</b>	100420	Ref. No. 40109500
	gas injector thread M10x1 WS 11 bore $\varnothing$ 0.95mm		
	<b>Part No.</b>	101997	Ref. No. 40114000
	gas injector thread M10x1 WS 11 bore $\varnothing$ 1.4mm		





			
1			
<b>Part No.</b>	105261	<b>Ref. No.</b>	22278932
<b>description</b>	tubular burner $\varnothing$ 74mm L 180mm W 75mm H 60mm for fryer round		

## accessories

### nozzle holders

			
1			
<b>Part No.</b>	104108	<b>Ref. No.</b>	22913400
<b>description</b>	nozzle holder nozzle mounting M10x1 tube $\varnothing$ 10mm gas inlet M16x1.5 gas outlet M14x1		
<b>For models:</b>	G2FS4-S, G4FD8-S, G4S+FCGN, G4S+FSGN, G6F12-S, G6S+FCGN, G6S+FSGN		
<b>accessories for</b>	104108		
	<b>Part No.</b>	102382	Ref. No. —
	nut thread M14x1 H 3.5mm WS 18 brass Qty 1 pcs		
	<b>Part No.</b>	104105	Ref. No. 22993300
	burner lower part for burner cap $\varnothing$ 80mm 3.5kW		
	<b>Part No.</b>	104107	Ref. No. 22993400
	burner lower part for burner cap $\varnothing$ 100mm 6.4kW		



			
1			
<b>Part No.</b>	105097	<b>Ref. No.</b>	32327600
<b>description</b>	nozzle holder nozzle mounting M10x1 tube ø 10mm gas inlet M16x1.5 gas outlet M14x1		
<b>For models:</b>	CPG40, CPG40E, CPG80, CPG80E, E9F15-4M, E9F15-8M, E9F18-4M, E9F18-8M, G6CP6, G6F2B, G6F2B+A2, G6F2BH6, G6F2BH9, G6F2BP6, G6F2BP9, G6F2H6+FE1, G6F2H6+FG1, G6F2H9+FE1, G6F2H9+FG1, G6F2H9+T, G6F2H9+TE, G6F2MH6, G6F2MH9, G6F2MP6, G6F2MP9, G6F2P6+FE1, G6F2P6+FG1, G6F2P9+FE1, G6F2P9+FG1, G6F2P9+T, G6F2P9+TE, G6F3BH12, G6F3H12+FE1, G6F3H12+FG1, G6F3H12+T, G6F3H12+TE, G6F3MH12, G6F4B, G6F4B+A4, G6F6B, G6F6B+A6, G6FL3B, G6FL3B-CR, G6FL3B-SX, G6FL3M, G6FL3M-CR, G6FL3M-SX, G6FL6B, G6FL6B-CR, G6FL6B-SX...(Other models you can see in the webshop)		
<b>accessories for</b>	105097		
	<b>Part No.</b>	<b>Ref. No.</b>	
	105094		31913600
	burner holder 3.5/6kW for burner cap ø 80/110mm		
	<b>Part No.</b>	<b>Ref. No.</b>	
	105724		35974400
	pilot burner bracket		
	<b>Part No.</b>	<b>Ref. No.</b>	
	107691		35912600
	burner holder D/E ø 33mm for burner cap ø 130/140mm		
	<b>Part No.</b>	<b>Ref. No.</b>	
	107934		32811500
	nut H 5mm thread M14x1 WS 17		

			
1			
<b>Part No.</b>	107521	<b>Ref. No.</b>	31327600
<b>description</b>	nozzle holder thread M10x1 screw pipe fitting 1/4" M6x0.75 tube ø 8mm		
<b>For models:</b>	G6F2H6+FG1, G6F2H9+FG1, G6F2P6+FG1, G6F2P9+FG1, G6F3H9+T, G6F4+FG1, G6F4+FG1+A4, G6F4PW+FG1, G6F4PW+FG1+AE, G6F6+FG1, G6F6+FG1+A6, G6F6PW+FG1, G6F6PW+T, G6F6PW+T+AE, G7F4+FG1, G7F4E+FG1, G7F4E+FG1+A4, G7F4P+FG1, G7F4P+FG1+AF1, G7F4PW+FG1, G7F4PW+FG1+AE, G7F6+FG1, G7F6E+FG1, G7F6E+FG1+A4, G7F6E+FG1+A6, G7F6P+FG1, G7F6P+FG1+AF1, G7F6PW+FG1, G7F6PW+FG1+AE, G7T4P2F+FG1, G7T4P4F+FG1, G7T7+FG1, G7T7P2F+FG1, G9F4E+FG1, G9F4E+FG1+A4, G9F4P+FG1, G9F4P+FG1+AF1, G9F4PW+FG1, G9F4PW+FG1+AE, G9F6E+FG1, G9F6E+FG1+A6, G9F6P+FG1, G9F6PW+FG1, G9F6PW+FG1+AE, G9F8P+2FG1, G9TP+FG1, G9TP2F+FG1		

<p>miscellaneous</p>			
			
1			
<b>Part No.</b>	107934	<b>Ref. No.</b>	32811500
<b>description</b>	nut H 5mm thread M14x1 WS 17		
<b>For models:</b>	G6F2B, G6F2B+A2, G6F2H6+FE1, G6F2H6+FG1, G6F2P6+FE1, G6F2P6+FG1, G6F4B, G6F4B+A4, G6F6B, G6F6B+A6, G7F2BP, G7F2MP, G7F4BP, G7F4MP, G7F4P+FG, G7F4P+FG+AF2, G7F4P+FG1, G7F4P+FG1+AF1, G7F6BP, G7F6MP, G7F6P+FG, G7F6P+FG+AF2, G7F6P+FG1, G7F6P+FG1+AF1, G7F6P+T, G7F6P+T+AF2, G7T4P2F+FG1, G7T4P2FB, G7T4P2FM, G7T4P4F+FG, G7T4P4F+FG1, G7T4P4FB, G7T4P4FM, G7TP+FG, G7TP2F+FG, G7TP2F+FG1, G7TP2F+T, G7TP2FM, G9F2MP, G9F4MP, G9F4P+FG, G9F4P+FG+AF2, G9F4P+FG1, G9F4P+FG1+AF1, G9F4PW+FG+AE, G9F6MP, G9F6P+FG, G9F6P+FG1, G9F6P+T, G9F6P+T+AF2...(Other models you can see in the webshop)		

## gas nozzles

### main nozzles

#### gas nozzles M6x0.75

			
1			
<b>Part No.</b>	104343	<b>Ref. No.</b>	40407400
<b>description</b>	gas injector thread M6x0.75 WS 7 bore ø 0.74mm		

			
1			
<b>Part No.</b>	106694	<b>Ref. No.</b>	40407500
<b>description</b>	gas injector thread M6x0.75 WS 7 bore ø 0.75mm		

			
1			
<b>Part No.</b>	100415	<b>Ref. No.</b>	40408500
<b>description</b>	gas injector thread M6x0.75 WS 7 bore ø 0.85mm		
<b>For models:</b>	G6F2H9+FG1, G6F2H9+T, G6F2M, G6F2P9+FG1, G6F2P9+T, G6F4+FE1, G6F4+FE1+A4, G6F4+FG1, G6F4+FG1+A4, G6F4M, G6F6+FE1, G6F6+FE1+A6, G6F6+FG1, G6F6+FG1+A6, G6F6M, G7F2BE, G7F2BE+A2, G7F2ME, G7F2ME+A2, G7F4+FG1, G7F4BE, G7F4BE+A4, G7F4E+FE, G7F4E+FE+A4, G7F4E+FE1, G7F4E+FE1+A4, G7F4E+FG, G7F4E+FG+A4, G7F4E+FG1, G7F4E+FG1+A4, G7F4ME, G7F4ME+A4, G7F4P+FG1, G7F4P+FG1+AF1, G7F6BE, G7F6BE+A6, G7F6E+FE, G7F6E+FE+A6, G7F6E+FE1, G7F6E+FE1+A6, G7F6E+FG, G7F6E+FG+A4, G7F6E+FG+A6, G7F6E+FG1, G7F6E+FG1+A4, G7F6E+FG1+A6, G7F6E+T, G7F6ME, G7F6P+FG1...(Other models you can see in the webshop)		

			
1			
<b>Part No.</b>	107823	<b>Ref. No.</b>	40409300
<b>description</b>	gas injector thread M6x0.75 WS 7 bore ø 0.93mm		
<b>For models:</b>	G6F2H6+FG1, G6F2H9+FG1, G6F2M, G6F2P6+FG1, G6F2P9+FG1, G6F4+FE1, G6F4+FE1+A4, G6F4+FG1, G6F4+FG1+A4, G6F4M, G6F6+FE1, G6F6+FE1+A6, G6F6+FG1, G6F6+FG1+A6, G6F6M, G7F2BE, G7F2BE+A2, G7F2ME, G7F4BE, G7F4BE+A4, G7F4E+FE, G7F4E+FE+A4, G7F4E+FE1, G7F4E+FE1+A4, G7F4E+FG, G7F4E+FG+A4, G7F4E+FG1, G7F4E+FG1+A4, G7F4ME, G7F6BE, G7F6BE+A6, G7F6E+FE, G7F6E+FE+A6, G7F6E+FE1, G7F6E+FE1+A6, G7F6E+FG, G7F6E+FG+A4, G7F6E+FG+A6, G7F6E+FG1, G7F6E+FG1+A4, G7F6E+FG1+A6, G7F6E+T, G7F6ME, G9F2ME, G9F2ME+A2, G9F4E+FE1, G9F4E+FE1+A4, G9F4E+FG1, G9F4E+FG1+A4, G9F4ME...(Other models you can see in the webshop)		



			
1			
<b>Part No.</b>	102553	<b>Ref. No.</b>	40413500
<b>description</b>	gas injector thread M6x0.75 WS 7 bore ø 1.35mm sunk bore		
<b>For models:</b>	G6F4+FG1, G6F4+FG1+A4, G7F4E+FG, G7F4E+FG+A4, G7F4E+FG1, G7F4E+FG1+A4, G7F6E+FG, G7F6E+FG+A4, G7F6E+FG+A6, G7F6E+T		

			
1			
<b>Part No.</b>	106683	<b>Ref. No.</b>	40109300
<b>description</b>	gas injector thread M10x1 WS 11 bore ø 0.93mm		
<b>For models:</b>	GL10+10B, GL10+10M, GL10B, GL10M		

			
1			
<b>Part No.</b>	104781	<b>Ref. No.</b>	40413000
<b>description</b>	gas injector thread M6x0.75 WS 7 bore ø 1.3mm		
<b>For models:</b>	G6F2H9+FG1, G6F2H9+T, G6F2M, G6F2P9+FG1, G6F2P9+T, G6F4+FE1, G6F4+FE1+A4, G6F4+FG1, G6F4+FG1+A4, G6F4M, G6F6+FE1, G6F6+FE1+A6, G6F6+FG1, G6F6+FG1+A6, G6F6M, G7F2BE, G7F2BE+A2, G7F2ME, G7F4+FG1, G7F4BE, G7F4BE+A4, G7F4E+FE, G7F4E+FE+A4, G7F4E+FE1, G7F4E+FE1+A4, G7F4E+FG, G7F4E+FG+A4, G7F4E+FG1, G7F4E+FG1+A4, G7F4ME, G7F4P+FG1, G7F4P+FG1+AF1, G7F6+FG1, G7F6BE, G7F6BE+A6, G7F6E+FE, G7F6E+FE+A6, G7F6E+FE1, G7F6E+FE1+A6, G7F6E+FG, G7F6E+FG+A4, G7F6E+FG+A6, G7F6E+FG1, G7F6E+FG1+A4, G7F6E+FG1+A6, G7F6E+T, G7F6ME, G7F6P+FG1, G7F6P+FG1+AF1, G7T4P2F+FG1... (Other models you can see in the webshop)		

			
1			
<b>Part No.</b>	100420	<b>Ref. No.</b>	40109500
<b>description</b>	gas injector thread M10x1 WS 11 bore ø 0.95mm		
<b>For models:</b>	G6F2B, G6F2B+A2, G6F2BH6, G6F2BH9, G6F2BP9, G6F2H6+FE1, G6F2H6+FG1, G6F2H9+FE1, G6F2MH6, G6F2MH9, G6F4B, G6F4B+A4, G6F6B, G6F6B+A6, G7F2B, G7F2M, G7F4+FE, G7F4+FE1, G7F4+FES, G7F4+FG, G7F4+FG1, G7F4B, G7F4M, G7F6+FE, G7F6+FE1, G7F6+FES, G7F6+FG, G7F6+FG1, G7F6+T, G7F6B, G7F6M, G7T4P2F+FG1, G7T4P2FB, G7T4P2FM, G7T4P4F+FG, G7T4P4F+FG1, G7T4P4FB, G7T4P4FM, G7TP2F+FG, G7TP2F+FG1, G7TP2F+T, G7TP2FM, G9F2M, G9F4+FE, G9F4+FE1, G9F4+FG, G9F4+FG1, G9F4M, G9F4P+FG, G9F6+FE... (Other models you can see in the webshop)		

			
1			
<b>Part No.</b>	104778	<b>Ref. No.</b>	40414500
<b>description</b>	gas injector thread M6x0.75 WS 7 bore ø 1.45mm		
<b>For models:</b>	G6F2H6+FG1, G6F2M, G6F2P6+FG1, G6F4+FE1, G6F4+FE1+A4, G6F4+FG1, G6F4+FG1+A4, G6F4M, G6F6+FE1, G6F6+FE1+A6, G6F6+FG1, G6F6+FG1+A6, G6F6M, G7F2BE, G7F2BE+A2, G7F2ME, G7F4BE, G7F4BE+A4, G7F4E+FE, G7F4E+FE+A4, G7F4E+FE1, G7F4E+-FE1+A4, G7F4E+FG, G7F4E+FG+A4, G7F4E+FG1, G7F4E+FG1+A4, G7F4ME, G7F6BE, G7F6BE+A6, G7F6E+FE, G7F6E+FE+A6, G7F6E+-FE1, G7F6E+FE1+A6, G7F6E+FG, G7F6E+FG+A4, G7F6E+FG+A6, G7F6E+FG1, G7F6E+FG1+A4, G7F6E+FG1+A6, G7F6E+T, G7F6ME, G9F2ME, G9F2ME+A2, G9F4E+FE1, G9F4E+FE1+A4, G9F4E+FG1, G9F4E+FG1+A4, G9F4ME, G9F4ME+A4, G9F6E+FE1... (Other models you can see in the webshop)		

			
1			
<b>Part No.</b>	106295	<b>Ref. No.</b>	40109000
<b>description</b>	gas injector thread M10x1 WS 11 bore ø 0.9mm code 90		
<b>For models:</b>	GL8+8B, GL8+8M, GL8B, GL8M		

			
1			
<b>Part No.</b>	106494	<b>Ref. No.</b>	40110500
<b>description</b>	gas injector thread M10x1 WS 11 bore ø 1.05mm		
<b>For models:</b>	GL30B, GL30M		

## gas nozzles M10x1

			
1			
<b>Part No.</b>	100646	<b>Ref. No.</b>	40512000
<b>description</b>	gas injector thread M10x1 WS 11 bore ø 1.2mm inner peaked		

			
1			
<b>Part No.</b>	107825	<b>Ref. No.</b>	40111500
<b>description</b>	gas injector thread M10x1 WS 11 bore ø 1.15mm code 115		

			
1			
<b>Part No.</b>	102705	<b>Ref. No.</b>	40108000
<b>description</b>	gas injector thread M10x1 WS 11 bore ø 0.8mm		





			
1			
<b>Part No.</b>	106490	<b>Ref. No.</b>	40112500
<b>description</b>	gas injector thread M10x1 WS 11 bore ø 1.25mm		
<b>For models:</b>	G6F2B, G6F2B+A2, G6F2BH6, G6F2BP6, G6F2H6+FE1, G6F2H6+FG1, G6F2MH6, G6F2MP6, G6F2P6+FE1, G6F2P6+FG1, G6F4B, G6F4B+A4, G6F6B, G6F6B+A6, G7F2B, G7F2BP, G7F2M, G7F2MP, G7F4+FE, G7F4+FE1, G7F4+FES, G7F4+FG, G7F4+FG1, G7F4B, G7F4BP, G7F4M, G7F4MP, G7F4P+FG, G7F4P+FG+AF2, G7F4P+FG1, G7F4P+FG1+AF1, G7F6+FE, G7F6+FE1, G7F6+FES, G7F6+FG, G7F6+FG1, G7F6+T, G7F6B, G7F6BP, G7F6M, G7F6MP, G7F6P+FG, G7F6P+FG+AF2, G7F6P+FG1, G7F6P+FG1+AF1, G7F6P+T, G7F6P+T+AF2, G7T4P2F+FG1, G7T4P2FB, G7T4P2FM...(Other models you can see in the webshop)		

			
1			
<b>Part No.</b>	106440	<b>Ref. No.</b>	40118500
<b>description</b>	gas injector thread M10x1 WS 11 bore ø 1.85mm		
<b>For models:</b>	9GL15+15M, 9GL15M, 9GL20+20M, 9GL20M, G6F2B, G6F2B+A2, G6F2BH6, G6F2BP6, G6F2H6+FE1, G6F2H6+FG1, G6F2MH6, G6F2MP6, G6F2P6+FE1, G6F2P6+FG1, G6F4B, G6F4B+A4, G6F6B, G6F6B+A6, G6F6B, G6F6B+A6, G7F2B, G7F2BP, G7F2M, G7F2MP, G7F4+FE, G7F4+FE1, G7F4+FES, G7F4+FG, G7F4+FG1, G7F4B, G7F4BP, G7F4M, G7F4MP, G7F4P+FG, G7F4P+FG+AF2, G7F4P+FG1, G7F4P+FG1+AF1, G7F6+FE, G7F6+FE1, G7F6+FES, G7F6+FG, G7F6+FG1, G7F6+T, G7F6B, G7F6BP, G7F6M, G7F6MP, G7F6P+FG, G7F6P+FG+AF2, G7F6P+FG1, G7F6P+FG1+AF1, G7F6P+T, G7F6P+T+AF2, G7T4P2F+FG1, G7T4P2FB, G7T4P2FM...(Other models you can see in the webshop)		

			
2			
<b>Part No.</b>	102704	<b>Ref. No.</b>	40112000
<b>description</b>	gas injector thread M10x1 WS 11 bore ø 1.2mm		
<b>For models:</b>	9GL15+15M, 9GL15M, 9GL20+20M, 9GL20M, G6FL3B, G6FL3B-SX, G6FL3M, G6FL3M-SX, G6FL6B, G6FL6B-SX, G6FL6M, G6FL6M-SX, G6FM6B, G6FM6M, G6FR3B, G6FR3M, G6FR6B, G6FR6M, G7FL4B, G7FL4B-CR, G7FL4B-SX, G7FL4M, G7FL4M-CR, G7FL4M-SX, G7FL8B-2, G7FL8B-2-CR, G7FL8B-2-SX, G7FL8M-2, G7FL8M-2-CR, G7FL8M-2-SX, G7FM8B-2, G7FM8M-2, G7FR4B, G7FR4M, G7FR8B-2, G7FR8M, G7FR8M-2, G7TP2F+FG, G7TP2F+FG1, G7TP2F+T, G7TP2FM, G9F4+FE, G9F4+FE1, G9F4+FG, G9F4+FG1, G9F4P+FG, G9F6+FE, G9F6+FE1, G9F6+FG, G9F6+FG1...(Other models you can see in the webshop)		

			
1			
<b>Part No.</b>	106498	<b>Ref. No.</b>	40119500
<b>description</b>	gas injector thread M10x1 WS 11 bore ø 1.95mm		

			
1			
<b>Part No.</b>	109116	<b>Ref. No.</b>	40110000
<b>description</b>	gas injector thread M10x1 WS 11 bore ø 1mm code 100		

			
1			
<b>Part No.</b>	106296	<b>Ref. No.</b>	40113000
<b>description</b>	gas injector thread M10x1 WS 11 bore ø 1.3mm code 130		
<b>For models:</b>	G9PL40B, G9PL40M, G9PL80B, G9PL80M, PLG40B, PLG40BE, PLG40M, PLG40ME, PLG80B, PLG80BE, PLG80M, PLG80ME		

			
1			
<b>Part No.</b>	106684	<b>Ref. No.</b>	40120500
<b>description</b>	gas injector thread M10x1 WS 11 bore ø 2.05mm		
<b>For models:</b>	G9PL40B, G9PL40M, G9PL80B, G9PL80M, PLG40B, PLG40BE, PLG40M, PLG40ME, PLG80B, PLG80BE, PLG80M, PLG80ME		

			
1			
<b>Part No.</b>	101997	<b>Ref. No.</b>	40114000
<b>description</b>	gas injector thread M10x1 WS 11 bore ø 1.4mm		
<b>For models:</b>	G6F2B, G6F2B+A2, G6F2BH6, G6F2BH9, G6F2BP9, G6F2H6+FE1, G6F2H6+FG1, G6F2H9+FE1, G6F2MH6, G6F2MH9, G6F4B, G6F4B+A4, G6F6B, G6F6B+A6, G7F2B, G7F2M, G7F4+FE, G7F4+FE1, G7F4+FES, G7F4+FG, G7F4+FG1, G7F4B, G7F4E+FG, G7F4E+FG+A4, G7F4M, G7F4P+FG, G7F4P+FG+AF2, G7F6+FE, G7F6+FE1, G7F6+FES, G7F6+FG, G7F6+FG1, G7F6+T, G7F6B, G7F6E+FG, G7F6E+FG+A4, G7F6E+FG+A6, G7F6M, G7F6P+FG, G7F6P+FG+AF2, G7T4P2F+FG1, G7T4P2FB, G7T4P2FM, G7T4P4F+FG, G7T4P4F+FG1, G7T4P4FB, G7T4P4FM, G7TP+FG, G7TP2F+FG, G7TP2F+FG1...(Other models you can see in the webshop)		

			
1			
<b>Part No.</b>	104069	<b>Ref. No.</b>	40123000
<b>description</b>	gas injector thread M10x1 WS 11 bore ø 2.3mm		
<b>For models:</b>	G6F2BH9, G6F2BP9, G6F2H9+FE1, G6F2H9+FG1, G6F2H9+T, G6F2MH9, G6F2MP9, G6F2P9+FE1, G6F2P9+FG1, G6F2P9+T, G9F2M, G9F2MP, G9F4M, G9F4MP, G9F4P+FG, G9F4P+FG+AF2, G9F4P+FG1, G9F4P+FG1+AF1, G9F6M, G9F6MP, G9F6P+FG, G9F6P+FG1, G9F6P+T, G9F6P+T+AF2, G9F8P+2FG, G9F8P+2FG1		



## pilot burner nozzles

## pilot burner nozzles POLIDORO



1

<b>Part No.</b>	100000	<b>Ref. No.</b>	40902200
<b>description</b>	pilot burner nozzle POLIDORO LPG code 22 bore $\varnothing$ 0.22mm Qty 1 pcs		
<b>For models:</b>	G6F2B, G6F2B+A2, G6F4B, G6F4B+A4, G6F6B, G6F6B+A6, G7T-4P2F+FG1, G7T4P2FB, G7T4P2FM, G7T4P4F+FG, G7T4P4F+FG1, G7T-4P4FB, G7T4P4FM, G7TP+FG, G7TP+FG1, G7TP2F+FG, G7TP2F+FG1, G7TP2F+T, G7TP2FM, G7TPM, G9TP+FG, G9TP+FG1, G9TP2F+FG, G9TP2F+FG1, G9TP2F+T, G9TP2FM, G9TPM		

## pilot burner nozzles SIT

## 160 series



1

<b>Part No.</b>	107172	<b>Ref. No.</b>	32365300 32366300
<b>description</b>	pilot burner nozzle SIT LPG code 25 Qty 1 pcs		
<b>For models:</b>	9GL15+15M, 9GL15M, 9GL20+20M, 9GL20M, CPG40, CPG40E, CPG80, CPG80E, E9F15-4M, E9F15-8M, E9F18-4M, E9F18-8M, G6CP6, G6FL3B, G6FL3B-SX, G6FL3M, G6FL3M-SX, G6FL6B, G6FL6B-SX, G6FL6M, G6FL6M-SX, G6FM6B, G6FM6M, G6FR3B, G6FR3M, G6FR6B, G6FR6M, G6PL60B, G6PL60M, G7FL4B, G7FL4B-CR, G7FL4B-SX, G7FL4M, G7FL4M-CR, G7FL4M-SX, G7FL8B-2, G7FL8B-2-CR, G7FL8B-2-SX, G7FL8M-2, G7FL8M-2-CR, G7FL8M-2-SX, G7FM8B-2, G7FM8M-2, G7FR4B, G7FR4M, G7FR8B-2, G7FR8M, G7FR8M-2, G9CP40, G9CP40-2...(Other models you can see in the webshop)		



1

<b>Part No.</b>	107650	<b>Ref. No.</b>	32366500
<b>description</b>	pilot burner nozzle SIT LPG code 30 Qty 1 pcs		



1

<b>Part No.</b>	107174	<b>Ref. No.</b>	32363600 32367100
<b>description</b>	pilot burner nozzle SIT natural gas code 41 Qty 1 pcs		
<b>For models:</b>	CPG40, CPG40E, CPG80, CPG80E, G6CP6, G6FL3B, G6FL3B-SX, G6FL3M, G6FL3M-SX, G6FL6B, G6FL6B-SX, G6FL6M, G6FL6M-SX, G6FM6B, G6FM6M, G6FR3B, G6FR3M, G6FR6B, G6FR6M, G6PL60B, G6PL60M, G7FL4B, G7FL4B-CR, G7FL4B-SX, G7FL4M, G7FL4M-CR, G7FL4M-SX, G7FL8B-2, G7FL8B-2-CR, G7FL8B-2-SX, G7FL8M-2, G7FL8M-2-CR, G7FL8M-2-SX, G7FM8B-2, G7FM8M-2, G7FR4B, G7FR4M, G7FR8B-2, G7FR8M, G7FR8M-2, G9FL4M, G9FL4M-SX, G9FL8M-2, G9FL8M-2-SX, G9FM8M-2, G9FR4M, G9FR8M-2, G9PL40B, G9PL40M, G9PL80B...(Other models you can see in the webshop)		



1

<b>Part No.</b>	107175	<b>Ref. No.</b>	32366900
<b>description</b>	pilot burner nozzle SIT natural gas code 51 Qty 1 pcs suitable for 160 series		
<b>For models:</b>	9GL15+15M, 9GL15M, 9GL20+20M, 9GL20M, E9F15-4M, E9F15-8M, E9F18-4M, E9F18-8M, G9CP40, G9CP40-2, G9CP80, G9CP80-2, GL10+10M, GL10M, GL30B, GL30M, GL8+8B, GL8+8M, GL8B, GL8M		

## bypass nozzles

## bypass nozzles PEL20/21



1

<b>Part No.</b>	100554	<b>Ref. No.</b>	22783500
<b>description</b>	bypass nozzle type PEL20/21 bore $\varnothing$ 0.45mm thread M5x0.5		
<b>For models:</b>	G6F2BH6, G6F2BPW, G6F2H6+FE1, G6F2H6+FG1, G6F2H9+FE1, G6F2H9+FG1, G6F2H9+T, G6F2H9+TE, G6F2MH6, G6F2MPW, G6F-2P9+FG1, G6F2P9+T, G6F2P9+TE, G6F4BPW, G6F4MPW, G6F4PW+-FE1, G6F4PW+FG1, G6F6BPW, G6F6MPW, G6F6PW+FE1, G6F-6PW+FG1, G6F6PW+T, G6F6PW+T+AE, G6F6PW+TE, G6F6PW+TE+AE, G7F2B, G7F2BPW, G7F2M, G7F2MPW, G7F4+FE, G7F4+FE1, G7F4+FES, G7F4+FG, G7F4+FG1, G7F4B, G7F4BPW, G7F4M, G7F4MPW, G7F4PW+FE, G7F4PW+FE1, G7F4PW+FG, G7F4PW+FG1, G7F6+FE, G7F6+FE1, G7F6+FES, G7F6+FG, G7F6+FG1, G7F6+T, G7F6B, G7F6BPW...(Other models you can see in the webshop)		



1

<b>Part No.</b>	100550	<b>Ref. No.</b>	22783600
<b>description</b>	bypass nozzle type PEL20/21 bore $\varnothing$ 0.55mm thread M5x0.5		

## bypass nozzles PEL22



1

<b>Part No.</b>	100392	<b>Ref. No.</b>	31782800
<b>description</b>	bypass nozzle type PEL22 bore $\varnothing$ 0.6mm thread M6x0.5		
<b>For models:</b>	G6FL3B, G6FL3B-CR, G6FL3B-SX, G6FL3M, G6FL3M-CR, G6FL3M-SX, G6FL6B, G6FL6B-CR, G6FL6B-SX, G6FL6M, G6FL6M-CR, G6FL6M-SX, G6FM6B, G6FM6M, G6FR3B, G6FR3M, G6FR6B, G6FR6M, G7FL4B, G7FL4B-CR, G7FL4B-SX, G7FL4M, G7FL4M-CR, G7FL4M-SX, G7FL8B-2, G7FL8B-2-CR, G7FL8B-2-SX, G7FL8M-2, G7FL8M-2-CR, G7FL8M-2-SX, G7FM8B-2, G7FM8M-2, G7FR4B, G7FR4M, G7FR8B-2, G7FR8M, G7FR8M-2		





## auxiliary gas parts

### screw connections

#### olives

			
1			
<b>Part No.</b>	107507	<b>Ref. No.</b>	32777200
<b>description</b>	olive for pipe Ø 10mm L 7mm Qty 1 pcs		
<b>For models:</b>	G6F2BPW, G6F2BPW+AE, G6F2MPW, G6F2MPW+AE, G6F4BPW, G6F4BPW+AE, G6F4MPW, G6F4MPW+AE, G6F4PW+FE1, G6F4PW+FE1+AE, G6F4PW+FG1, G6F4PW+FG1+AE, G6F6BPW, G6F6BPW+AE, G6F6MPW, G6F6MPW+AE, G6F6PW+FE1, G6F6PW+FE1+AE, G6F6PW+FG1, G6F6PW+FG1+AE, G6F6PW+T, G6F6PW+T+AE, G6F6PW+TE, G6F6PW+TE+AE, G7F2BPW, G7F2BPW+AE, G7F2BPW-F, G7F2MPW, G7F2MPW+AE, G7F4BPW, G7F4BPW+AE, G7F4MPW, G7F4MPW+AE, G7F4PW+FE, G7F4PW+FE+AE, G7F4PW+FE1, G7F-4PW+FE1+AE, G7F4PW+FG, G7F4PW+FG+AE, G7F4PW+FG1, G7F-4PW+FG1+AE, G7F6BPW, G7F6BPW+AE, G7F6MPW, G7F6MPW+AE, G7F6PW+FE, G7F6PW+FE+AE, G7F6PW+FE1, G7F6PW+FE1+AE, G7F6PW+FG... (Other models you can see in the webshop)		

			
1			
<b>Part No.</b>	101278	<b>Ref. No.</b>	32777300
<b>description</b>	olive for pipe Ø 10mm Qty 1 pcs		
<b>For models:</b>	G6F2B, G6F2B+A2, G6F2BPW, G6F2MPW, G6F4B, G6F4B+A4, G6F-4BPW, G6F4MPW, G6F4PW+FE1, G6F4PW+FG1, G6F6B, G6F6B+A6, G6F6BPW, G6F6MPW, G6F6PW+FE1, G6F6PW+FG1, G6F6PW+T, G6F6PW+TE, G7F2BP, G7F2BPW, G7F2MP, G7F2MPW, G7F4BP, G7F4BPW, G7F4MP, G7F4MPW, G7F4P+FG, G7F4P+FG+AF2, G7F4P+FG1, G7F4P+FG1+AF1, G7F4PW+FE, G7F4PW+FE1, G7F4PW+FG, G7F4PW+FG+AE, G7F4PW+FG1, G7F6BP, G7F6BPW, G7F6MP, G7F6MPW, G7F6P+FG, G7F6P+FG+AF2, G7F6P+FG1, G7F-6P+FG1+AF1, G7F6P+T, G7F6P+T+AF2, G7F6PW+FE, G7F6PW+FE1, G7F6PW+FG, G7F6PW+FG+AE... (Other models you can see in the webshop)		
<b>accessories for</b>	101278		
	<b>Part No.</b>	100943	<b>Ref. No.</b> —
	union nut thread M17x1 tube Ø 10mm		
	<b>Part No.</b>	101300	<b>Ref. No.</b> —
	union nut thread M16x1.5 tube Ø 10mm		
	<b>Part No.</b>	101478	<b>Ref. No.</b> —
	union nut thread 3/8" for pipe Ø 10mm		

			
1			
<b>Part No.</b>	101246	<b>Ref. No.</b>	31777500 31777700
<b>description</b>	olive for pipe Ø 4mm Qty 1 pcs		
<b>For models:</b>	G6F2B, G6F2B+A2, G6F2BPW, G6F2MPW, G6F4B, G6F4B+A4, G6F-4BPW, G6F4MPW, G6F4PW+FE1, G6F4PW+FG1, G6F6B, G6F6B+A6, G6F6BPW, G6F6MPW, G6F6PW+FE1, G6F6PW+FG1, G6F6PW+T, G6F6PW+TE, G7F2BP, G7F2BPW, G7F2MP, G7F2MPW, G7F4BP, G7F-4BPW, G7F4MP, G7F4MPW, G7F4P+FG, G7F4P+FG+AF2, G7F4P+FG1, G7F4P+FG1+AF1, G7F4PW+FE, G7F4PW+FE1, G7F4PW+FG, G7F-4PW+FG1, G7F6BP, G7F6BPW, G7F6MP, G7F6MPW, G7F6P+FG, G7F-6P+FG+AF2, G7F6P+FG1, G7F6P+FG1+AF1, G7F6P+T, G7F6P+T+AF2, G7F6PW+FE, G7F6PW+FE1, G7F6PW+FG, G7F6PW+FG1, G7F6PW+T, G7T4P2F+FG1... (Other models you can see in the webshop)		
<b>accessories for</b>	101246		
	<b>Part No.</b>	100908	<b>Ref. No.</b> —
	union screw thread M10x1 for pipe Ø 4mm Qty 1 pcs		

#### union nuts

			
1			
<b>Part No.</b>	107506	<b>Ref. No.</b>	32811600
<b>description</b>	union nut thread M14x1 tube Ø 10mm WS 17		
<b>For models:</b>	G6F2BPW, G6F2BPW+AE, G6F2MPW, G6F2MPW+AE, G6F4BPW, G6F4BPW+AE, G6F4MPW, G6F4MPW+AE, G6F4PW+FE1, G6F4PW+FE1+AE, G6F4PW+FG1, G6F4PW+FG1+AE, G6F6BPW, G6F6BPW+AE, G6F6MPW, G6F6MPW+AE, G6F6PW+FE1, G6F6PW+FE1+AE, G6F6PW+FG1, G6F6PW+FG1+AE, G6F6PW+T, G6F6PW+T+AE, G6F6PW+TE, G6F6PW+TE+AE, G7F2BPW, G7F2BPW+AE, G7F2BPW-F, G7F2MPW, G7F2MPW+AE, G7F4BPW, G7F4BPW+AE, G7F4MPW, G7F4MPW+AE, G7F4PW+FE, G7F4PW+FE+AE, G7F4PW+FE1, G7F-4PW+FE1+AE, G7F4PW+FG, G7F4PW+FG+AE, G7F4PW+FG1, G7F-4PW+FG1+AE, G7F6BPW, G7F6BPW+AE, G7F6MPW, G7F6MPW+AE, G7F6PW+FE, G7F6PW+FE+AE, G7F6PW+FG1, G7F6PW+FG1+AE, G7F6PW+FG... (Other models you can see in the webshop)		





## equipment-specific units

## for deep fryers

## lids



1

<b>Part No.</b>	696534	<b>Ref. No.</b>	33807700
<b>description</b>	lid with handle for fryer L 356mm W 283mm		
<b>For models:</b>	ELT15+15B, ELT15+15B-E, ELT15+15M, ELT15+15M-E, ELT15B, ELT15M, ELT15M-E, GL8+8B, GL8+8M, GL8B, GL8M		
<b>spare parts for</b>	696534		
	<b>Part No.</b>	692125	<b>Ref. No.</b> 33606100 336061000
	pull handle L 110mm H 36mm mounting distance 88mm hole ø 4mm		

## for tilting bratt pans

## spindles



1

<b>Part No.</b>	693345	<b>Ref. No.</b>	35993600
<b>description</b>	spindle ø 20mm total length 360mm		
<b>For models:</b>	E9BR8, E9BR8-I, G9BR8, G9BR8-I, SE9BR8, SE9BR8-I, SG9BR8, SG9BR8-I		

## miscellaneous



1

<b>Part No.</b>	693344	<b>Ref. No.</b>	35872000
<b>description</b>	threaded bush for tilting bratt pan		
<b>For models:</b>	E9BR8, E9BR8-I, G9BR8, G9BR8-I, SE9BR8, SE9BR8-I, SG9BR8, SG9BR8-I		

## for boiling pans

## level glasses

## complete



1

<b>Part No.</b>	540706	<b>Ref. No.</b>	31240000
<b>description</b>	level glass hole distance 76mm mounting thread M10 L 107mm W 28mm plastic/SS for kettle model ELESA HCX-76-BW-SST		
<b>For models:</b>	E7PI, G7PI		

## for contact grills

## miscellaneous



1

<b>Part No.</b>	699207	<b>Ref. No.</b>	30779100
<b>description</b>	coupling L 45mm W 25mm H 20mm		
<b>For models:</b>	PDL-ST, PDL-SX, PDM-ST, PDR-ST, PDR-VTR, PD-VTR, PM+VTR, PML-ST, PMR-ST, PMR-VTR, PM-VTR, PSL-ST, PSL-SX, PSM-ST, PSR-ST		

## for toasters

## pliers

## pliers



1

<b>Part No.</b>	690010	<b>Ref. No.</b>	30611300
<b>description</b>	plier for toaster H 180mm total length 100mm		
<b>For models:</b>	12T, 4TO, 6T		



knobs

producer-specific knobs

BERTO'S



1

<b>Part No.</b>	110073	<b>Ref. No.</b>	31875800
<b>description</b>	knob ø 72mm		
<b>For models:</b>	CPG40, CPG40E, CPG80, CPG80E, G6CP6, G6F2B, G6F2B+A2, G6F2BH6, G6F2BP6, G6F2MH6, G6F2MP6, G6F4B, G6F4B+A4, G6F6B, G6F6B+A6, G6FL3B, G6FL3B-CR, G6FL3B-SX, G6FL3M, G6FL3M-CR, G6FL3M-SX, G6FL6B, G6FL6B-CR, G6FL6B-SX, G6FL6M, G6FL6M-CR, G6FL6M-SX, G6FM6B, G6FM6M, G6FR3B, G6FR3M, G6FR6B, G6FR6M, G6PL60B, G6PL60M, G7F2B, G7F2BE, G7F2BE+A2, G7F2M, G7F2ME, G7F2ME+A2, G7F4+FE, G7F4+FE1, G7F4+FES, G7F4+FG, G7F4+FG1, G7F4B, G7F4BE, G7F4BE+A4, G7F4E+FE1...(Other models you can see in the webshop)		



1

<b>Part No.</b>	112692	<b>Ref. No.</b>	35878100 35878300
<b>description</b>	knob universal ø 72mm shaft ø 6x4.6mm shaft flat upper/lower silver		



1

<b>Part No.</b>	113026	<b>Ref. No.</b>	35875900
<b>description</b>	knob universal ø 72mm shaft ø 8x6.5mm shaft flat upper/lower black		



1

<b>Part No.</b>	111719	<b>Ref. No.</b>	35876300
<b>description</b>	knob without symbol ø 72mm BERTOS		
<b>For models:</b>	CPE40, E6BM3B, E6BM3M, E6BM6B, E6BM6M, E6CP6B, E6CP6M, E6CPM, E6P2M, E6P4M, E6P6+TE, E6P6M, E6PL60B, E6PL60M, E6PQ2P9+FE1, E6PQ2P9+TE, E7BR4B, E7BR4M, E7P2B-VTR, E7P2M, E7P2M-VTR, E7P4B-VTR, E7P4M, E7P4M-VTR, E7P4-VTR+FE, E7P4-VTR+FE1, E7P6M, E7PQ2B+T, E7PQ2M, E7PQ2M+T, E7PQ4+FE+T, E7PQ4+FE1+T, E7PQ4B+T, E7PQ4M, E7PQ4M+T, E7PQ6+FE+T, E7PQ6+FE1+T, E7PQ6B+T, E7PQ6M, E7PQ6M+T, E9BM4M, E9BM8M, E9CP40, E9F15-4M, E9F15-8M, E9F18-4M, E9F18-8M, E9P2M-VTR, E9P4+FE, E9P4+FE1...(Other models you can see in the webshop)		



1

<b>Part No.</b>	111556	<b>Ref. No.</b>	35876200
<b>description</b>	knob without symbol ø 72mm BERTOS shaft ø 6x4.6mm shaft flat lower		
<b>For models:</b>	E6F8-3B, E6F8-3M, E6F8-6B, E6F8-6M, E6FL3B, E6FL3BP, E6FL3B-P, E6FL3BP-CR, E6FL3BP-SX, E6FL3B-SX, E6FL3M, E6FL3MP, E6FL3M-P, E6FL3MP-CR, E6FL3MP-SX, E6FL3M-SX, E6FL6B-2, E6FL6B-2-SX, E6FL6BP-2, E6FL6BP-2-CR, E6FL6BP-2-SX, E6FL6M-2, E6FL6M-2-SX, E6FL6MP-2, E6FL6MP-2-CR, E6FL6MP-2-SX, E6FM6B-2, E6FM6BP-2, E6FM6M-2, E6FM6MP-2, E6FR3B, E6FR3BP, E6FR3M, E6FR3MP, E6FR6B-2, E6FR6BP-2, E6FR6M-2, E6FR6MP-2, E7F18-4M, E7F18-4MS, E7F18-8M, E7F18-8MS, E7P1, E9BR8, E9BR8-I, E9FL4M, E9FL4M-CPD, E9FL4M-CR, E9FL4MP, E9FL4MP-CPD...(Other models you can see in the webshop)		



1

<b>Part No.</b>	113024	<b>Ref. No.</b>	31876000 35876000
<b>description</b>	knob without symbol ø 72mm BERTOS shaft ø 6x4.6mm shaft flat upper		
<b>For models:</b>	E6P4+FE1, E6P6+FE1, E7BR8, E7P4+FE, E7P4+FE1, E7P4+FES, E7P6+FE, E7P6+FE1, E7P6+FES, E7PQ4+FE, E7PQ4+FE+T, E7PQ4+FE1, E7PQ4+FE1+T, E7PQ4+FES, E7PQ6+FE, E7PQ6+FE+T, E7PQ6+FE1, E7PQ6+FE1+T, E7PQ6+FES, ELT10+10B, ELT10B, ELT12+12B, ELT12B, ELT4+4B, ELT4B, G7F4+FE, G7F4+FE1, G7F4+FES, G7F4+FG, G7F4+FE1, G7F4+FE1+A4, G7F4+FE1+FG1, G7F4E+FG1+A4, G7F6+FE, G7F6+FE1, G7F6+FES, G7F6+FG, G7F6E+FE1, G7F6E+FE1+A6, G7F6E+FG1, G7F6E+FG1+A6		



1

<b>Part No.</b>	112875	<b>Ref. No.</b>	38951000
<b>description</b>	bezel gas tap with ignition flame ø 90mm		
<b>For models:</b>	G9P10D, G9P10DA, G9P10I, G9P10IA, G9P15D, G9P15DA, G9P15I, G9P15IA, G9P20D, G9P20DA, LXG9P15I, SG9P10D, SG9P10DA, SG-9P10I, SG9P10IA, SG9P15D, SG9P15DA, SG9P15I		



1

<b>Part No.</b>	112874	<b>Ref. No.</b>	38951200
<b>description</b>	bezel gas thermostat t.max. 300°C 170-300°C for gas oven ø 90mm		

mechanical components,  
equipment accessories

1

<b>Part No.</b>	110593	<b>Ref. No.</b>	31952200
<b>description</b>	knob dial plate gas tap with ignition flame t.max.°C PEL21 ED ø 63mm ID ø 45.5mm silver/red		
<b>For models:</b>	E9F15-4M, E9F15-8M, E9F18-4M, E9F18-8M, G12F4H9+FGP, G12F-4H9M, G12F4P9+FGP, G12F4P9M, G6F2B, G6F2B+A2, G6F2BH6, G6F2BH9, G6F2BP6, G6F2BP9, G6F2BPW, G6F2BPW+AE, G6F2H6+FE1, G6F2H6+FG1, G6F2H9+FG1, G6F2H9+T, G6F2H9+TE, G6F2MH6, G6F2MH9, G6F2MP6, G6F2MP9, G6F2MPW, G6F2MPW+AE, G6F2P6+-FE1, G6F2P6+FG1, G6F2P9+FG1, G6F2P9+T, G6F2P9+TE, G6F3BH12, G6F3BH9, G6F3H12+FE1, G6F3H12+FG1, G6F3H12+T, G6F3H12+TE, G6F3H9+T, G6F3MH12, G6F4B, G6F4B+A4, G6F4BPW, G6F4B PW+AE, G6F4MPW, G6F4MPW+AE, G6F4PW+FE1, G6F4PW+FE1+AE, G6F4PW+FG1, G6F4PW+FG1+AE...(Other models you can see in the webshop)		



<b>Part No.</b>	110594	<b>Ref. No.</b>	31952400
<b>description</b>	knob dial plate gas thermostat 1-8 t.max.°C SABAF ED ø 63mm ID ø 45.5mm silver/red		
<b>For models:</b>	G6F2H6+FG1, G6F2H9+FG1, G6F2P6+FG1, G6F2P9+FG1, G6F-3H12+FG1, G6F4PW+FG1, G6F4PW+FG1+AE, G6F6PW+FG1, G6F6PW+FG1+AE, G7F4+FG1, G7F4P+FG1, G7F4P+FG1+AF1, G7F4PW+FG1, G7F4PW+FG1+AE, G7F6+FG1, G7F6P+FG1, G7F-6P+FG1+AF1, G7F6PW+FG1, G7F6PW+FG1+AE, G7T4P2F+FG1, G7T4P4F+FG1, G7TP+FG, G7TP+FG1, G7TP2F+FG1, G9F4+FG1, G9F4E+FG1, G9F4E+FG1+A4, G9F4P+FG1, G9F4P+FG1+AF1, G9F-4PW+FG1, G9F4PW+FG1+AE, G9F6+FG1, G9F6E+FG1, G9F6E+F G1+A6, G9F6P+FG1, G9F6PW+FG1, G9F6PW+FG1+AE, G9F8+2FG1, G9F8P+2FG1, G9TP+FG, G9TP+FG1, G9TP2F+FG1		



<b>Part No.</b>	110590	<b>Ref. No.</b>	31952000
<b>description</b>	knob dial plate gas tap without ignition flame t.max.°C ED ø 63mm ID ø 45.5mm silver/red		
<b>For models:</b>	E7P2B-VTR, E7P2M-VTR, E7P4B-VTR, E7P4M-VTR, E7P4-VTR+FE, E7P4-VTR+FE1, G6F2B, G6F2B+A2, G6F2M, G6F2M+A2, G6F4+FE1, G6F4+FE1+A4, G6F4+FG1, G6F4+FG1+A4, G6F4B, G6F4B+A4, G6F4M, G6F4M+A4, G6F6+FE1, G6F6+FE1+A6, G6F6+FG1, G6F6+FG1+A6, G6F6+T, G6F6+T+A6, G6F6+TE, G6F6+TE+A6, G6F6B, G6F6B+A6, G6F6M, G6F6M+A6, G7F2BE, G7F2BE+A2, G7F2ME, G7F2ME+A2, G7F4BE, G7F4BE+A4, G7F4E+FE, G7F4E+FE+A4, G7F4E+FE1, G7F4E+-FE1+A4, G7F4E+FG, G7F4E+FG+A4, G7F4E+FG1, G7F4E+FG1+A4, G7F4ME, G7F4ME+A4, G7F6BE, G7F6BE+A6, G7F6E+FE, G7F6E+-FE+A6...(Other models you can see in the webshop)		



<b>Part No.</b>	110596	<b>Ref. No.</b>	31952600
<b>description</b>	knob dial plate oven TH/BH/TH+BH t.max.°C turn direction right ED ø 63mm ID ø 45.5mm silver/red		
<b>For models:</b>	E7P4+FE, E7P6+FE, E7PQ4+FE, E7PQ4+FE+T, E7PQ6+FE, E7P Q6+FE+T, E7TP+FE, E9P4+FE, E9P4P-VTR+FE, E9P4P-VTR+FE1, E9P4-VTR+FE, E9P4-VTR+FE1, E9P6+FE, E9PQ4+FE, E9PQ4+FE+T, E9PQ6+FE, E9PQ6+FE+T, G7F4PW+FE, G7F4PW+FE+AE, G7F6PW+FE, G7F6PW+FE+AE, G9F4+FE, G9F4PW+FE, G9F4PW+FE+AE, G9F6+FE, G9F6PW+FE, G9F6PW+FE+AE, G9F8+2FE, SE9P4P-VTR+FE, SE9PQ4+-FE, SE9PQ6+FE, SG9F4+FE, SG9F6+FE, SG9F8+2FE		



<b>Part No.</b>	110595	<b>Ref. No.</b>	31952300
<b>description</b>	knob dial plate gas thermostat 1-8 t.max.°C PEL ED ø 63mm ID ø 45.5mm silver/red		
<b>For models:</b>	E9FL4M, E9FL4M-CPD, E9FL4M-CR, E9FL4MP, E9FL4MP-CPD, E9FL4MP-CR, E9FL4MP-SX, E9FL4M-SX, E9FL8M-2, E9FL8M-2-CPD, E9FL8M-2-CR, E9FL8M-2-SX, E9FL8MP-2, E9FL8MP-2-CPD, E9FL8MP-2-CR, E9FL8MP-2-SX, E9FM8M-2, E9FM8MP-2, E9FR4M, E9FR4MP, E9FR8M-2, E9FR8MP-2, G6F2B, G6F2B+A2, G6F2H9+FE1, G6F2P9+-FE1, G6F3H12+T, G6F3H9+T, G6F4+FG1, G6F4+FG1+A4, G6F4B, G6F4B+A4, G6F6+FG1, G6F6+FG1+A6, G6F6+T, G6F6+T+A6, G6F6B, G6F6B+A6, G6F6PW+T, G6F6PW+T+AE, G6FL3B, G6FL3B-CR, G6FL3BSX, G6FL3M, G6FL3M-CR, G6FL3M-SX, G6FL6B, G6FL6B-CR, G6FL6BSX, G6FL6M...(Other models you can see in the webshop)		



<b>Part No.</b>	111721	<b>Ref. No.</b>	35954000
<b>description</b>	knob dial plate switch 0-1-2 t.max.°C silver/red		
<b>For models:</b>	E9P10I, E9P10IA, E9P15I, E9P15IA, SE9P10I, SE9P10IA, SE9P15I, SE9P15IA		



<b>Part No.</b>	113025	<b>Ref. No.</b>	30949300
<b>description</b>	knob dial plate switch 2-0-1 t.max.°C silver/red		

1

<b>Part No.</b>	110592	<b>Ref. No.</b>	31952500
<b>description</b>	knob dial plate switch 7-position t.max. °C°C ED ø 63mm ID ø 45.5mm silver/red		
<b>For models:</b>	E6P2B, E6P2M, E6P4+FE1, E6P4B, E6P4M, E6P6+FE1, E6P6+TE, E6P6B, E6P6M, E6PQ2BH6, E6PQ2BH6+T, E6PQ2BP9, E6PQ2H6+FE1, E6PQ2H6+FE1+T, E6PQ2MH6, E6PQ2MH6+T, E6PQ2MP9, E6PQ2P9+FE1, E6PQ2P9+TE, E7P2B, E7P2M, E7P4+FE, E7P4+FE1, E7P4+FES, E7P4B, E7P4M, E7P6+FE, E7P6+FE1, E7P6+FES, E7P6B, E7P6M, E7PQ2B, E7PQ2B+T, E7PQ2M, E7PQ2M+T, E7PQ4+FE, E7PQ4+FE+T, E7PQ4+FE1, E7PQ4+FE1+T, E7PQ4+FES, E7PQ4B, E7PQ4B+T, E7PQ4M, E7PQ4M+T, E7PQ6+FE, E7PQ6+FE+T, E7PQ6+FE1, E7PQ6+FE1+T, E7PQ6+FES, E7PQ6B...(Other models you can see in the webshop)		



1

<b>Part No.</b>	110598	<b>Ref. No.</b>	31953900
<b>description</b>	knob dial plate thermostat t.max. 195°C 100-195°C ED ø 63mm ID ø 45.5mm silver/red		
<b>For models:</b>	E6F10-3B, E6F10-3BS, E6F10-3M, E6F10-3MS, E6F10-6B, E6F10-6BS, E6F10-6M, E6F10-6MS, E6F8-3B, E6F8-3M, E6F8-6B, E6F8-6M, E7F10-4B, E7F10-4BS, E7F10-4M, E7F10-4MS, E7F10-8B, E7F10-8BS, E7F10-8M, E7F10-8MS, E7F18-4M, E7F18-4MS, E7F18-8M, E7F18-8MS, E7F30-8B, E7F30-8BP, E7F30-8M, E7F30-8MP, E9F15-4M, E9F15-8M, E9F18-4M, E9F18-8M, SE9F18-4M, SE9F18-8M		

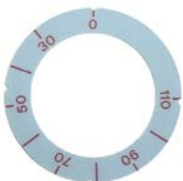

1

<b>Part No.</b>	110597	<b>Ref. No.</b>	31952700
<b>description</b>	knob dial plate thermostat t.max. 110°C 30-110°C rotation 270° ED ø 63mm ID ø 45.5mm silver/red		
<b>For models:</b>	E7BM4B, E7BM4M, E7BM8B, E7BM8M, E9BM4M, E9BM8M		



1

<b>Part No.</b>	110591	<b>Ref. No.</b>	31953500
<b>description</b>	knob dial plate thermostat t.max. 300°C 50-300°C ED ø 63mm ID ø 45.5mm silver/red		
<b>For models:</b>	E6BR6B, E6BR6M, E6FL3B, E6FL3BP, E6FL3B-P, E6FL3BP-CR, E6FL3BP-SX, E6FL3B-SX, E6FL3M, E6FL3MP, E6FL3M-P, E6FL3MP-CR, E6FL3MPSX, E6FL3M-SX, E6FL6B-2, E6FL6B-2-SX, E6FL6BP-2, E6FL6BP-2-CR, E6FL6BP-2-SX, E6FL6M-2, E6FL6M-2-SX, E6FL6MP-2, E6FL6MP-2-CR, E6FL6MP-2-SX, E6FM6B-2, E6FM6BP-2, E6FM6M-2, E6FM6MP-2, E6FR3B, E6FR3BP, E6FR3M, E6FR3MP, E6FR6B-2, E6FR6BP-2, E6FR6M-2, E6FR6MP-2, E6P4+FE1, E6P6+FE1, E6P6+TE, E6PQ2H6+FE1, E6PQ2H6+FE1+T, E6PQ2P9+FE1, E6PQ2P9+TE, E7BR4B, E7BR4M, E7BR8, E7BR8-I, E7FL4B, E7FL4B-CR, E7FL4BP...(Other models you can see in the webshop)		



1

<b>Part No.</b>	110599	<b>Ref. No.</b>	31954100
<b>description</b>	knob dial plate thermostat t.max. 110°C ED ø 63mm ID ø 45.5mm silver/red		
<b>For models:</b>	E7PI, G7PI		



1

<b>Part No.</b>	111722	<b>Ref. No.</b>	22874700
<b>description</b>	knob without symbol ø 60mm shaft ø 6x4.6mm shaft flat upper		



1

<b>Part No.</b>	111790	<b>Ref. No.</b>	35954100
<b>description</b>	knob dial plate thermostat t.max. 150°C ED ø 45.5mm ID ø 63mm silver/red		
<b>For models:</b>	E9P10I, E9P10IA, E9P15I, E9P15IA, SE9P10I, SE9P10IA, SE9P15I, SE9P15IA		



1

<b>Part No.</b>	111723	<b>Ref. No.</b>	22953400
<b>description</b>	knob dial plate gas thermostat 1-8		

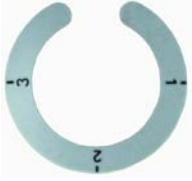
1

<b>Part No.</b>	112055	<b>Ref. No.</b>	22953800
<b>description</b>	knob dial plate switch 4-position		



1

<b>Part No.</b>	110771	<b>Ref. No.</b>	22651800
<b>description</b>	knob gas tap with ignition flame ø 60mm shaft ø 8x6.5mm shaft flat upper black		
<b>For models:</b>	GFLD8, GFLD8-CR, GFLM6, GFLM6-CR, GFLS4, GFLS4-CR, GFRD8, GFRM6, GFRS4		



1

<b>Part No.</b>	110049	<b>Ref. No.</b>	22650900
<b>description</b>	knob gas tap without ignition flame ø 60mm shaft ø 8x6.5mm shaft flat upper		
<b>For models:</b>	G2FS4, G2FS4-S, G4F+FCD8, G4F+FSD8, G4FD8, G4FD8-S, G4S+FCGN, G4S+FSGN, G6F12-S, G6S+FCGN, G6S+FSGN		



1

<b>Part No.</b>	110352	<b>Ref. No.</b>	22651400
<b>description</b>	knob gas thermostat 1-8 ø 60mm shaft ø 8x6.5mm shaft flat upper black		
<b>For models:</b>	G4S+FSGN, G6S+FSGN		



1

<b>Part No.</b>	110774	<b>Ref. No.</b>	22652400
<b>description</b>	knob oven ø 60mm shaft ø 6x4.6mm shaft flat lower black		



1

<b>Part No.</b>	110773	<b>Ref. No.</b>	22653100
<b>description</b>	knob switch 0-1 ø 60mm shaft ø 6x4.6mm shaft flat upper black		
<b>For models:</b>	EGRM4, EGRS4		



1

<b>Part No.</b>	110770	<b>Ref. No.</b>	22652300
<b>description</b>	knob switch 4-position ø 60mm shaft ø 6x4.6mm shaft flat upper		
<b>For models:</b>	ECRM6		



1

<b>Part No.</b>	110451	<b>Ref. No.</b>	22560700
<b>description</b>	knob switch 7-position ø 60mm shaft ø 6x4.6mm shaft flat upper black		



1

<b>Part No.</b>	110453	<b>Ref. No.</b>	22652100
<b>description</b>	knob thermostat t.max. 110°C 30-110°C ø 60mm shaft ø 6x4.6mm shaft flat upper black temperature range 30-110°C		
<b>For models:</b>	EBMD8, EBMM6, EBMS4		



1

<b>Part No.</b>	110455	<b>Ref. No.</b>	22652500
<b>description</b>	knob thermostat t.max. 195°C ø 60mm shaft ø 6x4.6mm shaft flat upper temperature range 100-195°C		
<b>For models:</b>	E10+10MB6, E10B4		

1

<b>Part No.</b>	110454	<b>Ref. No.</b>	22651600
<b>description</b>	knob thermostat t.max. 300°C 50-300°C ø 60mm shaft ø 6x4.6mm shaft flat upper		
<b>For models:</b>	EBRS4, EFLD8, EFLD8-CR, EFLM6, EFLM6-2, EFLM6-2-CR, EFLM6-CR, EFLS4, EFLS4-CR, EFM6-2, EFM6-2-CR, EFRM6, EFRS4, G4S+FCGN, G6S+FCGN		



1

<b>Part No.</b>	110452	<b>Ref. No.</b>	22651200
<b>description</b>	knob thermostat t.max. 300°C ø 60mm shaft ø 6x4.6mm shaft flat upper temperature range 50-300°C		
<b>For models:</b>	E4F+FCD8, E4F+FCDQ8, G4F+FCD8, G4F+FSD8		



1

<b>Part No.</b>	110764	<b>Ref. No.</b>	23653400
<b>description</b>	knob		
<b>For models:</b>	12T, SNACK-E, SNACK-E-LS, WAV-1, WAV1-GAS		



1

<b>Part No.</b>	110760	<b>Ref. No.</b>	27653300
<b>description</b>	knob graduated ø 52mm shaft ø 6x4.6mm shaft flat upper silver		
<b>For models:</b>	SA-E48, SA-E60, SA-E60-E, SA-E68M, SA-E68M-E		



1

<b>Part No.</b>	111753	<b>Ref. No.</b>	23652900
<b>description</b>	knob switch zero mark ø 37mm shaft ø 6x4.6mm shaft flat upper black		
<b>For models:</b>	WAV1-2, WAV2-3, WAV-E1-2, WAV-E2-3		



1

<b>Part No.</b>	110761	<b>Ref. No.</b>	30654500
<b>description</b>	knob switch zero mark ø 40mm shaft ø 6x4.6mm shaft flat right black		
<b>For models:</b>	ELT10+10B, ELT10B, ELT12+12B, ELT12+12M, ELT12B, ELT12M, ELT4+4B, ELT4B, PDL-LD, PDM-LD, PDR-LD, PDT-LD, PSL-LD, PSR-LD, PST-LD		



1

<b>Part No.</b>	110763	<b>Ref. No.</b>	30654700
<b>description</b>	knob switch zero mark ø 40mm shaft ø 6x4.6mm shaft flat right black		



1

<b>Part No.</b>	112876	<b>Ref. No.</b>	38877600
<b>description</b>	knob zero mark ø 69mm shaft ø 6x4.6mm shaft flat upper grey		
<b>For models:</b>	E6F10-3B, E6F10-3BS, E6F10-3M, E6F10-3MS, E6F10-6B, E6F10-6BS, E6F10-6M, E6F10-6MS, E6P2B, E6P2B-VTR, E6P2M-VTR, E6P4+FE1, E6P4B, E6P4B-VTR, E6P4M-VTR, E6P6+FE1, E6P6B, E7BM4B, E7BM4M, E7BM8B, E7BM8M, E7F10-4B, E7F10-4BS, E7F10-4M, E7F10-4MS, E7F10-8B, E7F10-8BS, E7F10-8M, E7F10-8MS, E7FL4B, E7FL4B-CR, E7FL4BP, E7FL4BP-CR, E7FL4BP-SX, E7FL4B-SX, E7FL4M, E7FL4M CR, E7FL4MP, E7FL4MP-CR, E7FL4MP-SX, E7FL4M-SX, E7FL8B-2, E7FL8B-2-CR, E7FL8B-2-SX, E7FL8B-2-VTR, E7FL8BP-2, E7FL8BP-2-CR, E7FL8BP-2-SX, E7FL8M-2, E7FL8M-2-CR...(Other models you can see in the webshop)		



1

<b>Part No.</b>	112686	<b>Ref. No.</b>	38877100
<b>description</b>	knob zero mark ø 69mm shaft ø 8x6.5mm shaft flat upper grey edition since 11/2011		
<b>For models:</b>	E9P2M, E9P4M, E9P6M, E9PQ2M, E9PQ2M+T, E9PQ4M, E9PQ4M+T, E9PQ6M, E9PQ6M+T, G12F4H9+FGP, G12F4H9M, G12F4P9+FGP, G12F4P9M, G6F2BH9, G6F2BP9, G6F2BPW, G6F2BPW+AE, G6F-2H6+FE1, G6F2H6+FG1, G6F2H9+FE1, G6F2H9+FG1, G6F2H9+T, G6F2H9+TE, G6F2MH9, G6F2MP9, G6F2MPW, G6F2MPW+AE, G6F2P6+FE1, G6F2P6+FG1, G6F2P9+FE1, G6F2P9+FG1, G6F2P9+T, G6F2P9+TE, G6F3BH12, G6F3BH9, G6F3H12+FE1, G6F3H12+FG1, G6F3H12+T, G6F3H12+TE, G6F3H9+T, G6F3MH12, G6F4+FG1, G6F4+FG1+A4, G6F4BPW, G6F4BPW+AE, G6F4MPW, G6F4MPW+AE, G6F4PW+FE1, G6F4PW+FE1+AE, G6F4PW+FG1...(Other models you can see in the webshop)		



## accessories

### fascias



<b>Part No.</b>	112875	<b>Ref. No.</b>	38951000
<b>description</b>	bezel gas tap with ignition flame ø 90mm		
<b>For models:</b>	G9P10D, G9P10DA, G9P10I, G9P10IA, G9P15D, G9P15DA, G9P15I, G9P15IA, G9P20D, G9P20DA, LXG9P15I, SG9P10D, SG9P10DA, SG-9P10I, SG9P10IA, SG9P15D, SG9P15DA, SG9P15I		



<b>Part No.</b>	112874	<b>Ref. No.</b>	38951200
<b>description</b>	bezel gas thermostat t.max. 300°C 170-300°C for gas oven ø 90mm		

## handles and hand wheels

### hand wheels

#### hand wheels



<b>Part No.</b>	514398	<b>Ref. No.</b>	31995000
<b>description</b>	hand wheel ø 200mm D1 ø 40mm bore ø 15mm depth of bore 20mm thread M6 hole distance 6mm groove widthmm L1 35mm L2 70mm handle length 90mm with folding handle		
<b>For models:</b>	E7BR8, E7BR8-I, G7BR8, G7BR8-I		



<b>Part No.</b>	692430	<b>Ref. No.</b>	35995000
<b>description</b>	hand wheel ø 200mm D1 ø 50mm bore ø 20mm thread groove width 6mm groove depth 13mm mounting distance 30mm L1 47mm L2 50mm handle length 90mm with folding handle		
<b>For models:</b>	E9BR8, E9BR8-I, G9BR8, G9BR8-I, SE9BR8, SE9BR8-I, SG9BR8, SG9BR8-I		

## cylindrical handles

### fixed



<b>Part No.</b>	540235	<b>Ref. No.</b>	30661400
<b>description</b>	cylindrical handle thread M6 ø 17mm L 40mm		
<b>For models:</b>	E6CP3B, E7F30-8B, E7F30-8BP, PDL-LD, PDM-LD, PDR-LD, PDT-LD, PSLLD, PSR-LD, PST-LD, SE9BM4M, SE9BM8M		

## ball handles



<b>Part No.</b>	540323	<b>Ref. No.</b>	35604000
<b>description</b>	ball handle thread M10 ø 40mm with metal bush black		
<b>For models:</b>	E9P10D, E9P10I, E9P10IA, E9P15D, E9P15I, E9P15IA, G9P10D, G9P10DA, G9P10I, G9P10IA, G9P15D, G9P15DA, G9P15I, G9P15IA, G9P20D, G9P20DA, LXE9P15I, LXG9P15I, SE9P10I, SE9P10IA, SE9P15I, SE9P15IA, SG9P10D, SG9P10DA, SG9P10I, SG9P10IA, SG9P15D, SG9P15DA, SG9P15I		

## handle bars

### consoles



<b>Part No.</b>	111243	<b>Ref. No.</b>	31978400
<b>description</b>	console		



## bracket handles

			
1			
<b>Part No.</b>	692125	<b>Ref. No.</b>	33606100 336061000
<b>description</b>	pull handle L 110mm H 36mm mounting distance 88mm hole ø 4mm		
<b>For models:</b>	9GL15+15M, 9GL15M, 9GL20+20M, 9GL20M, E6CP6B, E6CP6M, E6CPM, E6F10-3B, E6F10-3BS, E6F10-3M, E6F10-3MS, E6F10-6B, E6F10-6BS, E6F10-6M, E6F10-6MS, E6F8-3B, E6F8-3M, E6F8-6B, E6F8-6M, E7F10-4B, E7F10-4BS, E7F10-4M, E7F10-4MS, E7F10-8B, E7F10-8BS, E7F10-8M, E7F10-8MS, E7F18-4M, E7F18-4MS, E7F18-8M, E7F18-8MS, E9F15-4M, E9F15-8M, E9F18-4M, E9F18-8M, ELT10+10B, ELT10+10B-E, ELT10B, ELT10B-E, ELT12+12B, ELT12+12B-E, ELT12+12M, ELT12+12M-E, ELT12B, ELT12B-E, ELT12M, ELT12M-E, ELT15+15B, ELT15+15B-E, ELT15+15M...(Other models you can see in the webshop)		

			
2			
<b>Part No.</b>	699206	<b>Ref. No.</b>	27604500
<b>description</b>	pull handle L 205mm H 49mm mounting distance 180mm thread M8 W 28mm		
<b>For models:</b>	E6CP6B, E6CP6M, E7F30-8B, E7F30-8BP, E7F30-8M, E7F30-8MP, GL15+15M, GL15M, GL18+18MI, GL18+18MI-E, GL18MI, GL18MI-E, GL20+20M, GL20M, S9GL20+20M, S9GL20M, SA-E60, SA-E60-E, SE9F18-4M, SE9F18-8M		



## locks



### handle latches

#### universal

#### outside fixing

#### locks

			
1			
<b>Part No.</b>	694065	<b>Ref. No.</b>	25884400
<b>description</b>	door handle for headed units L 145mm W 40mm H 62mm spring length 33mm outer black		
<b>spare parts for</b>	694065		
	<b>Part No.</b>	514390	<b>Ref. No.</b> —
spring for door handle ø 6mm L 54mm W 27.5mm			
	<b>Part No.</b>	694734	<b>Ref. No.</b> —
door handle L 165mm W 40mm H 25mm black			

<b>spare parts for</b>	694065		
	<b>Part No.</b>	694735	<b>Ref. No.</b> —
cap ø 32mm black			
<b>accessories for</b>	694065		
	<b>Part No.</b>	694066	<b>Ref. No.</b> —
door catch with spigot 2-stage L 28mm W 14mm H 15mm H1 16mm total length 51mm thread M8 thread L 23mm stainless steel			
	<b>Part No.</b>	694067	<b>Ref. No.</b> —
door catch with spigot 1-stage L 26mm total length 51mm thread M8			

## producer-specific

### BERTO'S

			
1			
<b>Part No.</b>	694065	<b>Ref. No.</b>	25884400
<b>description</b>	door handle for headed units L 145mm W 40mm H 62mm spring length 33mm outer black		
<b>spare parts for</b>	694065		
	<b>Part No.</b>	514390	<b>Ref. No.</b> —
spring for door handle ø 6mm L 54mm W 27.5mm			
	<b>Part No.</b>	694734	<b>Ref. No.</b> —
door handle L 165mm W 40mm H 25mm black			
	<b>Part No.</b>	694735	<b>Ref. No.</b> —
cap ø 32mm black			
<b>accessories for</b>	694065		
	<b>Part No.</b>	694066	<b>Ref. No.</b> —
door catch with spigot 2-stage L 28mm W 14mm H 15mm H1 16mm total length 51mm thread M8 thread L 23mm stainless steel			
	<b>Part No.</b>	694067	<b>Ref. No.</b> —
door catch with spigot 1-stage L 26mm total length 51mm thread M8			







## edgmount latches

## handle latches

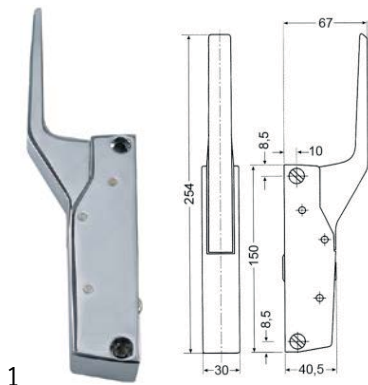
## CAFF/FERMOD



1

<b>Part No.</b>	700060	<b>Ref. No.</b>	23604400
<b>description</b>	handle latch L 150mm mounting distance 133mm non lockable heated units G 791		
<b>For models:</b>	FME06M, FME10, FME10EP, FME10M, FME20, FME20M, FME6, FMG10, FMG10EP, FMG10M, FMG20, FMG20M, FMG6, FMG6EP, FMG6M, FPE12TURBO, FPE6TURBO, FPG12, FPG6, WAV-E12, WAVE12T, WAV-E12TURBO, WAV-E20, WAV-E6, WAV-E6T, WAV-E6TURBO, WAV-G12, WAV-G20, WAV-G6		
<b>accessories for</b>	700060		
	<b>Part No.</b>	700061	<b>Ref. No.</b> 23579700
	door catch L 58mm W 20mm H 35mm mounting distance 42mm chrome-plated brass for headed units		
	<b>Part No.</b>	700062	<b>Ref. No.</b> —
	handle protection heated units		

## door catches



1

<b>Part No.</b>	700061	<b>Ref. No.</b>	23579700
<b>description</b>	door catch L 58mm W 20mm H 35mm mounting distance 42mm chrome-plated brass for headed units		
<b>For models:</b>	FME06M, FME10, FME10EP, FME10M, FME20, FME20M, FME6, FMG10, FMG10EP, FMG10M, FMG20, FMG20M, FMG6, FMG6EP, FMG6M, FPE12TURBO, FPE6TURBO, FPG12, FPG6, WAV-E12, WAVE12T, WAV-E12TURBO, WAV-E20, WAV-E6, WAV-E6T, WAV-E6TURBO, WAV-G12, WAV-G20, WAV-G6		
<b>accessories for</b>	700061		
	<b>Part No.</b>	690414	<b>Ref. No.</b> —
	handle latch L 150mm mounting distance 133mm non lockable refrigeration units G 791		

## snap locks

## universal



1

<b>Part No.</b>	690864	<b>Ref. No.</b>	24579500
<b>description</b>	door catch L 38mm W 13mm H 21mm mounting distance 28mm zamak with spigot		
<b>For models:</b>	FPE10A, FPE10B, FPE10C, FPE10D, FPE5A, FPE5B, FPE5C, FPE5D, FPG10A, FPG10B, FPG5A, FPG5B, FPG5C, FPG5D, WAV-E5U, WAV-G5U		



1

<b>Part No.</b>	690596	<b>Ref. No.</b>	24577700 + 24579500
<b>description</b>	snap lock L 60mm W 15mm H 36mm mounting distance 48/28mm spring thickness 1.5mm complete with door catch zamak		



1

<b>Part No.</b>	690863	<b>Ref. No.</b>	24577700
<b>description</b>	snap lock L 60mm W 16mm mounting distance 48mm spring thickness 1.5mm without door catch zamak		
<b>For models:</b>	FPE10A, FPE10B, FPE10C, FPE10D, FPE5A, FPE5B, FPE5C, FPE5D, FPG10A, FPG10B, FPG10C, FPG10D, FPG5A, FPG5B, FPG5C, FPG5D, WAV-E5U, WAV-G5U		



1

<b>Part No.</b>	700803	<b>Ref. No.</b>	23577300
<b>description</b>	snap lock L 69mm W 12.5mm H 20mm mounting distance 57mm complete with door catch brass		
<b>For models:</b>	WAV-E1-2, WAV-E2-3		



1

<b>Part No.</b>	690903	<b>Ref. No.</b>	23578800
<b>description</b>	snap lock L 69mm W 13mm H 20mm mounting distance 57mm complete with door catch nickel-plated brass		
<b>For models:</b>	WAV-E1-2, WAV-E2-3		



## espagnolette locks

### producer-specific

#### BERTO'S



1

<b>Part No.</b>	690829	<b>Ref. No.</b>	N/A
<b>description</b>	bush H 8mm ID ø 8mm ED ø 26mm		



1

<b>Part No.</b>	690828	<b>Ref. No.</b>	N/A
<b>description</b>	bush L 20mm brass ID ø 10mm ED ø 15mm		



1

<b>Part No.</b>	514317	<b>Ref. No.</b>	25938600
<b>description</b>	disc ID ø 11mm ED ø 17mm H 3mm brass		
<b>For models:</b>	FC60EM, FC60EP, FC60GEP, FC60GM, FMG6, FMG6EP, FMG6M, FPE6TURBO, FPG6, MM06EA, MM06EB, MM06GA, MM06GB, MM10EA, MM10EB, MM10GA, MM10GB, MM2-3EA, MM2-3EB, WAV-E6, WAV-E6TURBO, WAV-G6		



1

<b>Part No.</b>	514321	<b>Ref. No.</b>	25760000
<b>description</b>	door catch with roller L 35mm W 26mm H 32mm mounting distance 20mm rollerø 10mm		
<b>For models:</b>	FC100EM, FC100EP, FC100GEP, FC100GM, FC200EA, FC200EB, FC200GA, FC200GB, FC60EM, FC60EP, FC60GEP, FC60GM, FMG6, FMG6EP, FMG6M, FPE6TURBO, FPG6, MM06EA, MM06EB, MM-06GA, MM06GB, MM10EA, MM10EB, MM10GA, MM10GB, WAV-E6, WAV-E6TURBO, WAV-G6		



1

<b>Part No.</b>	514316	<b>Ref. No.</b>	25605100
<b>description</b>	door handle black		
<b>For models:</b>	FME06M, FME10, FME10EP, FME10M, FME20, FME20M, FME6, FMG10, FMG10EP, FMG10M, FMG20, FMG20M, FMG6, FMG6EP, FMG6M, FPE12TURBO, FPE6TURBO, FPG12, FPG6, MM06EA, MM06EB, MM-06GA, MM06GB, MM10EA, MM10EB, MM10GA, MM10GB, MM2-3EA, MM2-3EB, WAV-E12, WAV-E12T, WAV-E12TURBO, WAV-E20, WAV-E6, WAV-E6T, WAV-E6TURBO, WAV-G12, WAV-G20, WAV-G6		

<b>accessories for</b>	514316			
	<b>Part No.</b>	514321	<b>Ref. No.</b>	25760000
	door catch with roller L 35mm W 26mm H 32mm mounting distance 20mm rollerø 10mm			
	<b>Part No.</b>	690826	<b>Ref. No.</b>	N/A
	striker bolt L1 60mm L2 64mm D1 ø 20mm D2 ø 10mm			

<b>accessories for</b>	514316			
	<b>Part No.</b>	690862	<b>Ref. No.</b>	25878100
	latch gear opening to the right shaft intake ø 8x8mm L 170mm W 40mm H 29mm			
	<b>Part No.</b>	691655	<b>Ref. No.</b>	N/A
	striker bolt L1 60mm L2 95mm D1 ø 20mm D2 ø 10mm			



1

<b>Part No.</b>	690827	<b>Ref. No.</b>	N/A
<b>description</b>	latch block L 40mm brass hole ø 20mm dimensions 30x30mm		



1

<b>Part No.</b>	690862	<b>Ref. No.</b>	25878100
<b>description</b>	latch gear opening to the right shaft intake ø 8x8mm L 170mm W 40mm H 29mm		
<b>For models:</b>	FC100EM, FC100EP, FC100GEP, FC100GM, FC200EA, FC200EB, FC200GA, FC200GB, FC60EM, FC60EP, FC60GEP, FC60GM, FME06M, FME10, FME10EP, FME10M, FME20, FME20M, FME6, FMG10, FMG10EP, FMG10M, FMG20, FMG20M, FMG6, FMG6EP, FMG6M, FPE12TURBO, FPE6TURBO, FPG12, FPG6, MM06EA, MM06EB, MM06GA, MM06GB, MM10EA, MM10EB, MM10GA, MM10GB, WAV-E12, WAV-E12T, WAV-E12TURBO, WAV-E20, WAV-E6, WAV-E6T, WAV-E6TURBO, WAV-G12, WAV-G20, WAV-G6		

<b>accessories for</b>	690862			
	<b>Part No.</b>	514317	<b>Ref. No.</b>	25938600
	disc ID ø 11mm ED ø 17mm H 3mm brass			
	<b>Part No.</b>	514321	<b>Ref. No.</b>	25760000
	door catch with roller L 35mm W 26mm H 32mm mounting distance 20mm rollerø 10mm			

	<b>Part No.</b>	690826	<b>Ref. No.</b>	N/A
	striker bolt L1 60mm L2 64mm D1 ø 20mm D2 ø 10mm			

	<b>Part No.</b>	690827	<b>Ref. No.</b>	N/A
	latch block L 40mm brass hole ø 20mm dimensions 30x30mm			

	<b>Part No.</b>	690828	<b>Ref. No.</b>	N/A
	bush L 20mm brass ID ø 10mm ED ø 15mm			

	<b>Part No.</b>	690829	<b>Ref. No.</b>	N/A
	bush H 8mm ID ø 8mm ED ø 26mm			

	<b>Part No.</b>	691637	<b>Ref. No.</b>	—
	roll pin ø 3mm L 20mm			

	<b>Part No.</b>	691653	<b>Ref. No.</b>	N/A
	striker bolt L1 60mm L2 240mm D1 ø 20mm D2 ø 10mm			

	<b>Part No.</b>	691654	<b>Ref. No.</b>	N/A
	striker bolt L1 60mm L2 113mm D1 ø 20mm D2 ø 10mm			



	<b>Part No.</b>	691655	<b>Ref. No.</b>	N/A
	striker bolt L1 60mm L2 95mm D1 ø 20mm D2 ø 10mm			

	<b>Part No.</b>	691655	<b>Ref. No.</b>	N/A
	striker bolt L1 60mm L2 95mm D1 ø 20mm D2 ø 10mm			

Table continues overleaf

1 mechanical components, equipment accessories



accessories for	690862		
	<b>Part No.</b>	691656	Ref. No. N/A
striker bolt L1 60mm L2 315mm D1 ø 20mm D2 ø 10mm			
	<b>Part No.</b>	691657	Ref. No. N/A
striker bolt L1 60mm L2 283mm D1 ø 20mm D2 ø 10mm			
	<b>Part No.</b>	691658	Ref. No. N/A
striker bolt L1 60mm L2 570mm D1 ø 20mm D2 ø 10mm			

	<b>Part No.</b>	691654	Ref. No. N/A
<b>description</b> striker bolt L1 60mm L2 113mm D1 ø 20mm D2 ø 10mm			

	<b>Part No.</b>	691653	Ref. No. N/A
<b>description</b> striker bolt L1 60mm L2 240mm D1 ø 20mm D2 ø 10mm			

	<b>Part No.</b>	691657	Ref. No. N/A
<b>description</b> striker bolt L1 60mm L2 283mm D1 ø 20mm D2 ø 10mm			

	<b>Part No.</b>	691656	Ref. No. N/A
<b>description</b> striker bolt L1 60mm L2 315mm D1 ø 20mm D2 ø 10mm			

	<b>Part No.</b>	691658	Ref. No. N/A
<b>description</b> striker bolt L1 60mm L2 570mm D1 ø 20mm D2 ø 10mm			

	<b>Part No.</b>	690826	Ref. No. N/A
<b>description</b> striker bolt L1 60mm L2 64mm D1 ø 20mm D2 ø 10mm			

	<b>Part No.</b>	691655	Ref. No. N/A
<b>description</b> striker bolt L1 60mm L2 95mm D1 ø 20mm D2 ø 10mm			

## hinges

### oven hinges

	<b>Part No.</b>	700003	Ref. No. 22608200
<b>description</b> opposite support L 110mm W 12mm mounting distance 94mm			
<b>For models:</b> E4F+FCD8, E4F+FCDQ8, E6P4+FE1, E6P6+FE1, E6P6+TE, E6PQ2H6+-FE1, E6PQ2H6+FE1+T, E6PQ2P9+FE1, E6PQ2P9+TE, E7P4+FE1, E7P4-VTR+FE1, E7P6+FE1, E7PQ4+FE1, E7PQ4+FE1+T, E7PQ6+FE1, E7PQ6+FE1+T, E9P4+FE1, E9P4P-VTR+FE1, E9P4-VTR+FE1, E9P6+FE1, E9PQ4+FE1, E9PQ4+FE1+T, E9PQ6+FE1, E9PQ6+FE1+T, G4F+FCD8, G4F+FSD8, G4S+FCGN, G4S+FSGN, G6F2H6+FE1, G6F2H6+FG1, G6F2H9+FE1, G6F2H9+FG1, G6F2P9+FE1, G6F2P9+TE, G6F3H12+FE1, G6F3H12+FG1, G6F3H12+T, G6F3H12+TE, G6F3H9+T, G6F4+FE1, G6F4+FE1+A4, G6F4+FG1, G6F4+FG1+A4, G6F4PW+FE1, G6F4PW+-FE1+AE...(Other models you can see in the webshop)			

	<b>Part No.</b>	700001	Ref. No. 31802500
<b>description</b> opposite support L 118mm W 17mm mounting distance 94mm			
<b>For models:</b> E6PQ2P9+FE1, E7P4+FE, E7P4+FE1, E7P4+FES, E7P4-VTR+FE, E7P4-VTR+FE1, E7P6+FE, E7P6+FE1, E7P6+FES, E7PQ4+FE, E7PQ4+-FE+T, E7PQ4+FE1, E7PQ4+FE1+T, E7PQ4+FES, E7PQ6+FE, E7PQ6+-FE+T, E7PQ6+FE1, E7PQ6+FE1+T, E7PQ6+FES, E7TP+FE, E9P4+FE, E9P4+FE1, E9P4+FES, E9P4P-VTR+FE, E9P4P-VTR+FE1, E9P4-VTR+FE, E9P4-VTR+FE1, E9P4-VTR+FES, E9P6+FE, E9P6+FE1, E9P6+FES, E9PQ4+FE, E9PQ4+FE+T, E9PQ4+FE1, E9PQ4+FE1+T, E9PQ4+FES, E9PQ6+FE, E9PQ6+FE+T, E9PQ6+FE1, E9PQ6+FE1+T, E9PQ6+FES, G12F4P9+FGP, G6F2B, G6F2B+A2, G6F2H9+FE1, G6F2H9+FG1, G6F2P9+FE1, G6F2P9+FG1, G6F4B, G6F4B+A4...(Other models you can see in the webshop)			





1

<b>Part No.</b>	690499	<b>Ref. No.</b>	22608100
<b>description</b>	oven hinge mounting distance 118mm lug mounting 13mm lever length 119mm groove distance 12mm spring thickness 4mm mounting ear position left spring length 59mm L 155mm W 21mm		
<b>For models:</b>	E4F+FCD8, E4F+FCDQ8, E6P4+FE1, E6P6+FE1, E6P6+TE, E6PQ2H6+-FE1, E6PQ2H6+FE1+T, E6PQ2P9+FE1, E6PQ2P9+TE, E7P4+FE1, E7P4-VTR+FE1, E7P6+FE1, E7PQ4+FE1, E7PQ4+FE1+T, E7PQ6+FE1, E7PQ6+FE1+T, E9P4+FE1, E9P4P-VTR+FE1, E9P4-VTR+FE1, E9P6+FE1, E9PQ4+FE1, E9PQ4+FE1+T, E9PQ6+FE1, E9PQ6+FE1+T, G4F+FCD8, G4F+FSD8, G4S+FCGN, G4S+FSGN, G6F2H6+FE1, G6F2H6+FG1, G6F2H9+FE1, G6F2H9+FG1, G6F2H9+T, G6F2H9+TE, G6F2P6+FE1, G6F2P6+FG1, G6F2P9+FE1, G6F2P9+FG1, G6F2P9+T, G6F2P9+TE, G6F3H12+FE1, G6F3H12+FG1, G6F3H12+T, G6F3H12+TE, G6F3H9+T, G6F4+FE1, G6F4+FE1+A4, G6F4+FG1, G6F4+FG1+A4, G6F4PW+FE1... (Other models you can see in the webshop)		
<b>accessories for</b>	690499		
	<b>Part No.</b>	700003	<b>Ref. No.</b> 22608200
	opposite support L 110mm W 12mm mounting distance 94mm		





1

<b>Part No.</b>	690498	<b>Ref. No.</b>	22607800
<b>description</b>	oven hinge mounting distance 118mm lug mounting 13mm lever length 119mm groove distance 12mm spring thickness 4mm mounting ear position right spring length 59mm L 155mm W 21mm		
<b>For models:</b>	E4F+FCD8, E4F+FCDQ8, E6P4+FE1, E6P6+FE1, E6P6+TE, E6PQ2H6+-FE1, E6PQ2H6+FE1+T, E6PQ2P9+FE1, E6PQ2P9+TE, E7P4+FE1, E7P4-VTR+FE1, E7P6+FE1, E7PQ4+FE1, E7PQ4+FE1+T, E7PQ6+FE1, E7PQ6+FE1+T, E9P4+FE1, E9P4-VTR+FE1, E9P6+FE1, E9PQ4+FE1, E9PQ4+FE1+T, E9PQ6+FE1, E9PQ6+FE1+T, G4F+FCD8, G4F+FSD8, G4S+FCGN, G4S+FSGN, G6F2H6+FE1, G6F2H6+FG1, G6F2H9+FE1, G6F2H9+FG1, G6F2H9+T, G6F2H9+TE, G6F2P6+FE1, G6F2P6+FG1, G6F2P9+FE1, G6F2P9+FG1, G6F2P9+T, G6F2P9+TE, G6F3H12+FE1, G6F3H12+FG1, G6F3H12+T, G6F3H12+TE, G6F3H9+T, G6F4+FE1, G6F4+FE1+A4, G6F4+FG1, G6F4+FG1+A4, G6F4PW+FE1, G6F4PW+-FE1+AE... (Other models you can see in the webshop)		
<b>accessories for</b>	690498		
	<b>Part No.</b>	700003	<b>Ref. No.</b> 22608200
	opposite support L 110mm W 12mm mounting distance 94mm		





1

<b>Part No.</b>	700006	<b>Ref. No.</b>	31802100
<b>description</b>	oven hinge mounting distance 173mm mounting distance 2 105mm lug mounting 14mm lever length 120mm groove distance 11mm spring thickness 3.5mm mounting ear position left spring length 112mm W 25mm		
<b>For models:</b>	E6PQ2P9+FE1, E7P4+FE, E7P4+FE1, E7P4+FES, E7P4-VTR+FE, E7P4-VTR+FE1, E7P6+FE, E7P6+FE1, E7P6+FES, E7PQ4+FE, E7PQ4+-FE+T, E7PQ4+FE1, E7PQ4+FE1+T, E7PQ4+FES, E7PQ6+FE, E7PQ6+-FE+T, E7PQ6+FE1, E7PQ6+FE1+T, E7PQ6+FES, E7TP+FE, E9P4+FE, E9P4+FE1, E9P4+FES, E9P4P-VTR+FE, E9P4P-VTR+FE1, E9P4-VTR+FE, E9P4-VTR+FE1, E9P4-VTR+FES, E9P6+FE, E9P6+FE1, E9P6+FES, E9PQ4+FE, E9PQ4+FE+T, E9PQ4+FE1, E9PQ4+FE1+T, E9PQ4+FES, E9PQ6+FE, E9PQ6+FE+T, E9PQ6+FE1, E9PQ6+FE1+T, E9PQ6+FES, G12F4H9+FGP, G12F4P9+FGP, G6F2B, G6F2B+A2, G6F2H9+FE1, G6F2H9+FG1, G6F2P9+FE1, G6F2P9+FG1, G6F4B... (Other models you can see in the webshop)		
<b>accessories for</b>	700006		
	<b>Part No.</b>	700001	<b>Ref. No.</b> 31802500
	opposite support L 118mm W 17mm mounting distance 94mm		
	<b>Part No.</b>	700007	<b>Ref. No.</b> 31802000
	oven hinge mounting distance 173mm mounting distance 2 105mm lug mounting 14mm lever length 120mm groove distance 11mm spring thickness 3.5mm mounting ear position right spring length 112mm W 25mm		

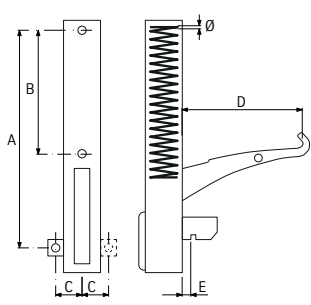

1



<b>Part No.</b>	700007	<b>Ref. No.</b>	31802000
<b>description</b>	oven hinge mounting distance 173mm mounting distance 2 105mm lug mounting 14mm lever length 120mm groove distance 11mm spring thickness 3.5mm mounting ear position right spring length 112mm W 25mm		
<b>For models:</b>	E6PQ2P9+FE1, E7P4+FE, E7P4+FE1, E7P4+FES, E7P4-VTR+FE, E7P4-VTR+FE1, E7P6+FE, E7P6+FE1, E7P6+FES, E7PQ4+FE, E7PQ4+-FE+T, E7PQ4+FE1, E7PQ4+FE1+T, E7PQ4+FES, E7PQ6+FE, E7PQ6+-FE+T, E7PQ6+FE1, E7PQ6+FE1+T, E7PQ6+FES, E7TP+FE, E9P4+FE, E9P4+FE1, E9P4+FES, E9P4P-VTR+FE, E9P4P-VTR+FE1, E9P4-VTR+FE, E9P4-VTR+FE1, E9P4-VTR+FES, E9P6+FE, E9P6+FE1, E9P6+FES, E9PQ4+FE, E9PQ4+FE+T, E9PQ4+FE1, E9PQ4+FE1+T, E9PQ4+FES, E9PQ6+FE, E9PQ6+FE+T, E9PQ6+FE1, E9PQ6+FE1+T, E9PQ6+FES, G12F4H9+FGP, G12F4P9+FGP, G6F2B, G6F2B+A2, G6F2H9+FE1, G6F2H9+FG1, G6F2P9+FE1, G6F2P9+FG1, G6F4B... (Other models you can see in the webshop)		
<b>accessories for</b>	700007		
	<b>Part No.</b>	700001	<b>Ref. No.</b> 31802500
	opposite support L 118mm W 17mm mounting distance 94mm		



## door bearing



1

<b>Part No.</b>	514306	<b>Ref. No.</b>	0045D
<b>description</b>	hinge bearing mounting pos. bottom left without bolt		



1

<b>Part No.</b>	514308	<b>Ref. No.</b>	1004A
<b>description</b>	hinge bearing mounting pos. bottom left without bolt		



1

<b>Part No.</b>	514310	<b>Ref. No.</b>	0321.0S
<b>description</b>	hinge bearing mounting pos. bottom left without bolt		



1

<b>Part No.</b>	514313	<b>Ref. No.</b>	12025
<b>description</b>	hinge bearing mounting pos. lower without bolt		
<b>For models:</b>	FC200GB		



1

<b>Part No.</b>	514315	<b>Ref. No.</b>	30082
<b>description</b>	hinge bearing mounting pos. lower without bolt		
<b>For models:</b>	MM2-3EA, MM2-3EB		



1

<b>Part No.</b>	514305	<b>Ref. No.</b>	0046B
<b>description</b>	hinge bearing mounting pos. upper left without bolt		



1

<b>Part No.</b>	514307	<b>Ref. No.</b>	1003A
<b>description</b>	hinge bearing mounting pos. upper left without bolt		
<b>For models:</b>	WAV-G5U		



1

<b>Part No.</b>	514309	<b>Ref. No.</b>	0322C
<b>description</b>	hinge bearing mounting pos. upper left without bolt		
<b>For models:</b>	MM-10-EB		



1

<b>Part No.</b>	514311	<b>Ref. No.</b>	15.0007.01
<b>description</b>	hinge bearing mounting pos. upper left without bolt		



1

<b>Part No.</b>	514312	<b>Ref. No.</b>	12024
<b>description</b>	hinge bearing mounting pos. upper left without bolt		
<b>For models:</b>	FC200GB		



1

<b>Part No.</b>	514314	<b>Ref. No.</b>	30083
<b>description</b>	hinge bearing mounting pos. upper left without bolt		
<b>For models:</b>	MM2-3EA, MM2-3EB		



## fittings for catering equipment

### outlet taps

#### producer-specific

#### BERTO'S



1

<b>Part No.</b>	540658	<b>Ref. No.</b>	32686300 32686900
<b>description</b>	ball valve connection 3/4" IT - 3/4" IT DN20 total length 69mm		
<b>For models:</b>	9GL15+15M, 9GL15M, 9GL20+20M, 9GL20M, CPE40, CPG40, CPG40E, CPG80, CPG80E, E6F8-3M, E6F8-6M, E7F10-4B, E7F10-4BS, E7F10-4M, E7F10-4MS, E7F10-8B, E7F10-8BS, E7F10-8M, E7F10-8MS, E7F18-4M, E7F18-4MS, E7F18-8M, E7F18-8MS, E7F30-8M, E7F30-8MP, E9F15-4M, E9F15-8M, E9F18-4M, E9F18-8M, ELT12+12M, ELT12+12M-E, ELT12M, ELT12M-E, ELT15+15M, ELT15+15M-E, ELT15M, ELT15M-E, ELT18+18M, ELT18+18M-E, ELT18+18M-E224, ELT18M, ELT18M-E, ELT30M, G6CP6, G9BM4M, G9CP40, G9CP40-2, G9CP80, G9CP80-2, GL10+10M...(Other models you can see in the webshop)		



1

<b>Part No.</b>	514120	<b>Ref. No.</b>	32685400
<b>description</b>	outlet tap L 84mm spout ø 22mm thread 3/4" IT		
<b>For models:</b>	6GL18B, 6GL18M, E6BM3B, E6BM3M, E6BM6B, E6BM6M, E6CP3B, E6CP6B, E6CP6M, E6CPM, E6F10-3B, E6F10-3BS, E6F10-3M, E6F10-3MS, E6F10-6B, E6F10-6BS, E6F10-6M, E6F10-6MS, E6F8-3B, E6F8-6B, E6PL60B, E6PL60M, E7BM4B, E7BM4M, E7BM8B, E7BM8M, E7F30-8B, E7F30-8BP, E9BM4M, E9BM8M, E9PL40M, E9PL80M, ELT10+10B, ELT10+10B-E, ELT10B, ELT10B-E, ELT12+12B, ELT12+12B-E, ELT12B, ELT12B-E, ELT15+15B, ELT15+15B-E, ELT15B, ELT15B-E, ELT16B, ELT18+18B, ELT18+18BE, ELT18+18B-E, ELT18B, ELT18BE...(Other models you can see in the webshop)		

### aerators and air bleeders



1

<b>Part No.</b>	540824	<b>Ref. No.</b>	31990600
<b>description</b>	pressure compensation valve thread 1/4" ET WS 19 chrome-plated L 18mm		
<b>For models:</b>	E7PI, G7PI		

### lid hinges

#### ELECTROLUX

#### spare parts



1

<b>Part No.</b>	693299	<b>Ref. No.</b>	31878200
<b>description</b>	torsion spring ø 28.6mm L2 103mm wire gauge ø 3.6mm L1 45mm		
<b>For models:</b>	E7PI, G7PD, G7PI		

### inlet taps



1

<b>Part No.</b>	514210	<b>Ref. No.</b>	22686400
<b>description</b>	shut-off valve		
<b>For models:</b>	ECRM6		



1

<b>Part No.</b>	514205	<b>Ref. No.</b>	31686800 (old version)
<b>description</b>	shut-off valve thread 1/2"		



## drain taps

brass

drain taps





<b>Part No.</b>	540132	<b>Ref. No.</b>	3127440
-----------------	--------	-----------------	---------

**description** drain tap 1 1/2" IT conical seal kettle A 90mm B 137mm B1 70mm chrome-plated brass

**spare parts for** 540132

	<b>Part No.</b>	540213	<b>Ref. No.</b>	—
		handle ID ø 5mm L 117mm		

	<b>Part No.</b>	540461	<b>Ref. No.</b>	—
		shim for drain tap		

	<b>Part No.</b>	540464	<b>Ref. No.</b>	—
		nut for drain tap thread 1 1/2"		

**accessories for** 540132

	<b>Part No.</b>	510404	<b>Ref. No.</b>	—
		flat gasket fibre ED ø 44mm ID ø 34mm thickness 2mm Qty 1 pcs		





<b>Part No.</b>	540131	<b>Ref. No.</b>	31274300
-----------------	--------	-----------------	----------

**description** drain tap 1 1/4" IT chrome-plated brass

**For models:** E7PI, G7PD, G7PI

**spare parts for** 540131

	<b>Part No.</b>	540213	<b>Ref. No.</b>	—
		handle ID ø 5mm L 117mm		

	<b>Part No.</b>	540461	<b>Ref. No.</b>	—
		shim for drain tap		

	<b>Part No.</b>	540464	<b>Ref. No.</b>	—
		nut for drain tap thread 1 1/2"		

## FITTINGS FOR CATERING EQUIPMENT BERTOS



<b>Part No.</b>	540275	<b>Ref. No.</b>	35274800
-----------------	--------	-----------------	----------

**description** drain tap 2" IT with union nut A 90mm B 151mm B1 80mm chrome-plated brass

**For models:** E9P10I, E9P10IA, E9P15I, E9P15IA, G9P10D, G9P10DA, G9P10I, G9P10IA, G9P15D, G9P15DA, G9P15I, G9P15IA, G9P20D, G9P20DA, LXE9P15I, LXG9P15I, SE9P10I, SE9P10IA, SE9P15I, SE9P15IA, SG9P10D, SG9P10DA, SG9P10I, SG9P10IA, SG9P15D, SG9P15DA, SG9P15I

**spare parts for** 540275

	<b>Part No.</b>	540214	<b>Ref. No.</b>	—
		handle ID ø 6mm L 145mm		

**accessories for** 540275

	<b>Part No.</b>	529484	<b>Ref. No.</b>	—
		flat gasket fibre ED ø 58mm ID ø 50mm thickness 2mm Qty 1 pcs		

	<b>Part No.</b>	542448	<b>Ref. No.</b>	35859800
		gasket silicone 60x49x2 for drain tap 2"		

## accessories



<b>Part No.</b>	542448	<b>Ref. No.</b>	35859800
-----------------	--------	-----------------	----------

**description** gasket silicone 60x49x2 for drain tap 2"

**For models:** E9P10D, E9P10I, E9P10IA, E9P15D, E9P15I, E9P15IA, G9P10D, G9P10DA, G9P10I, G9P10IA, G9P15D, G9P15DA, G9P15I, G9P15IA, LXE9P15I, SE9P10I, SE9P10IA, SE9P15I, SE9P15IA, SG9P10D, SG9P10DA, SG9P10I, SG9P10IA, SG9P15D, SG9P15DA, SG9P15I

## steam traps

steam traps

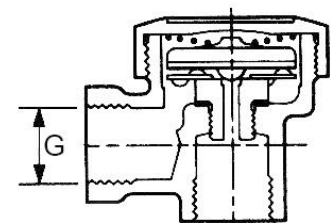

<b>Part No.</b>	540784	<b>Ref. No.</b>	31954600
-----------------	--------	-----------------	----------

**description** thermostatic steam trap thread 1/2" type BPT13A brass

**For models:** E7PI, G7PI



safety fittings



safety fittings





1	<b>Part No.</b>	514501	<b>Ref. No.</b>	31857400
<b>description</b> safety fitting thread 3/4" 0.5bar with manometer chrome-plated brass H 235mm				
<b>For models:</b> E7PI, E9P10I, E9P10IA, E9P15I, E9P15IA, G7PI, G9P10I, G9P10IA, G9P15I, G9P15IA, SE9P10I, SE9P10IA, SE9P15I, SE9P15IA, SG9P10I, SG9P10IA, SG9P15I				
<b>spare parts for</b> 514501				
	<b>Part No.</b>	514122	<b>Ref. No.</b>	—
safety valve triggering pressure 0.5bar with CE approval thread 3/4"				
	<b>Part No.</b>	540822	<b>Ref. No.</b>	—
fitting support thread 3/4"				
	<b>Part No.</b>	540827	<b>Ref. No.</b>	—
aerator and air bleeder thread 3/4" ET chrome-plated L 45mm ø 36mm				
	<b>Part No.</b>	540828	<b>Ref. No.</b>	31954900
manometer siphon thread 3/8"				
	<b>Part No.</b>	541062	<b>Ref. No.</b>	31875700
manometer ø 63mm pressure range 0 up to 1bar connection marking adjustable kettle thread 1/4"				

accessories

1			
<b>Part No.</b>	540836	<b>Ref. No.</b>	31273900
<b>description</b> funnel thread 1/2" with shut-off valve			
<b>For models:</b> E7PI, G7PI			

1				
<b>Part No.</b>	540835	<b>Ref. No.</b>	31287500	
<b>description</b> screw cap thread 3/4"				
<b>For models:</b> E7PI, E9P10I, E9P10IA, E9P15I, E9P15IA, G7PI, G9P10I, G9P10IA, G9P15I, G9P15IA, SE9P10I, SE9P10IA, SE9P15I, SE9P15IA, SG9P10I, SG9P10IA, SG9P15I				
<b>spare parts for</b> 540835				
	<b>Part No.</b>	513016	<b>Ref. No.</b>	—
O-ring EPDM thickness 3.53mm ID ø 26.58mm Qty 1 pcs				

<b>accessories for</b>	540835			
	<b>Part No.</b>	513016	<b>Ref. No.</b>	—
O-ring EPDM thickness 3.53mm ID ø 26.58mm Qty 1 pcs				

1			
<b>Part No.</b>	540828	<b>Ref. No.</b>	31954900
<b>description</b> manometer siphon thread 3/8"			
<b>For models:</b> E7PI, E9P10I, E9P10IA, E9P15I, E9P15IA, G7PI, G9P10I, G9P10IA, G9P15I, G9P15IA, SE9P10I, SE9P10IA, SE9P15I, SE9P15IA, SG9P10I, SG9P10IA, SG9P15I			

baskets

fryer baskets

BERTO'S

1			
<b>Part No.</b>	970230	<b>Ref. No.</b>	33614400
<b>description</b> fryer basket L1 235mm W1 200mm H1 100mm L2 395mm H2 210mm chrome-plated steel			
<b>For models:</b> ELT10+10B, ELT10+10B-E, ELT10B, ELT10B-E, ELT12+12B, ELT12+12B-E, ELT12B, ELT12B-E, ELT15+15B, ELT15+15B-E, ELT15B, ELT15B-E, ELT18+18B, ELT18+18BE, ELT18B, ELT18BE, ELT8+8B, ELT8+8B-E, ELT8B, ELT8B-E, GL8+8B, GL8+8M, GL8B, GL8M			

1			
<b>Part No.</b>	970225	<b>Ref. No.</b>	33502000
<b>description</b> fryer basket L1 255mm W1 95mm H1 110mm L2 440mm H2 170mm H3 230mm chrome-plated steel			
<b>For models:</b> E6F10-3B, E6F10-3BS, E6F10-3M, E6F10-3MS, E6F10-6B, E6F10-6BS, E6F10-6M, E6F10-6MS, E6F8-3B, E6F8-3M, E6F8-6B, E6F8-6M, E7F10-4B, E7F10-4BS, E7F10-4M, E7F10-4MS, E7F10-8B, E7F10-8BS, E7F10-8M, E7F10-8MS			





1



<b>Part No.</b>	970231	<b>Ref. No.</b>	33614600
-----------------	--------	-----------------	----------

<b>description</b>	fryer basket L1 275mm W1 210mm H1 110mm H2 155mm H3 205mm
--------------------	---

<b>For models:</b>	6GL18B, 6GL18M, E6F10-3B, E6F10-3BS, E6F10-3M, E6F10-3MS, E6F10-6B, E6F10-6BS, E6F10-6M, E6F10-6MS, E6F8-3B, E6F8-3M, E6F8-6B, E6F8-6M, E7F10-4B, E7F10-4BS, E7F10-4M, E7F10-4MS, E7F10-8B, E7F10-8BS, E7F10-8M, E7F10-8MS, ELT10+10B, ELT10+10B-E, ELT10B, ELT10B-E, ELT12+12B, ELT12+12B-E, ELT12+12M, ELT12+12M-E, ELT12B, ELT12B-E, ELT12M, ELT12M-E, ELT15+15B, ELT15+15B-E, ELT15+15M, ELT15+15M-E, ELT15B, ELT15B-E, ELT15M, ELT15M-E, ELT18+18B, ELT18+18BE, ELT18+18B-E, ELT18+18M-E, ELT18+18M-E224, ELT18B, ELT18BE, ELT18M...(Other models you can see in the webshop)
--------------------	--

2



<b>Part No.</b>	970451	<b>Ref. No.</b>	2250200
-----------------	--------	-----------------	---------

<b>description</b>	fryer basket L1 280mm W1 100mm H1 100mm chrome-plated steel
--------------------	---

1



<b>Part No.</b>	970215	<b>Ref. No.</b>	22617400
-----------------	--------	-----------------	----------

<b>description</b>	fryer basket L1 280mm W1 200mm H1 100mm chrome-plated steel
--------------------	---

<b>For models:</b>	E10+10MB6, E10B4
--------------------	------------------

1



<b>Part No.</b>	970217	<b>Ref. No.</b>	22617132
-----------------	--------	-----------------	----------

<b>description</b>	fryer basket L1 300mm W1 230mm H1 105mm
--------------------	---

1



<b>Part No.</b>	970226	<b>Ref. No.</b>	32617100
-----------------	--------	-----------------	----------

<b>description</b>	fryer basket L1 300mm W1 245mm H1 110mm
--------------------	---

<b>For models:</b>	ELT10+10B-E, ELT10B-E, ELT12+12B-E, ELT12+12M-E, ELT12B-E, ELT12M-E, ELT15+15B, ELT15+15B-E, ELT15+15M, ELT15+15M-E, ELT15B, ELT15B-E, ELT15M, ELT15M-E, ELT18+18B, ELT18+18BE, ELT18+18B-E, ELT18+18M, ELT18+18M-E, ELT18+18M-E224, ELT18B, ELT18BE, ELT18B-E, ELT18M, ELT18M-E, GL10+10B, GL10+10BB, GL10+10M, GL10B, GL10B4, GL10M, GL15+15M, GL15M, GL20+20M, GL20M
--------------------	---

## pasta baskets

## BERTO'S (1)

1



<b>Part No.</b>	970717	<b>Ref. No.</b>	31613900
-----------------	--------	-----------------	----------

<b>description</b>	pasta basket H1 200mm W1 140mm L1 105mm for 700
--------------------	---

<b>For models:</b>	CPG40, CPG40E, CPG80, CPG80E, G6CP6
--------------------	-------------------------------------

1



<b>Part No.</b>	970719	<b>Ref. No.</b>	35614900
-----------------	--------	-----------------	----------

<b>description</b>	pasta basket H1 200mm W1 140mm L1 140mm for 900
--------------------	---

1



<b>Part No.</b>	970729	<b>Ref. No.</b>	31613800
-----------------	--------	-----------------	----------

<b>description</b>	pasta basket H1 200mm W1 290mm L1 105mm H3 400mm SS
--------------------	---

<b>For models:</b>	CPE40, CPG40, CPG40E, CPG80, CPG80E, E9CP40, G9CP40, G9CP40-2, G9CP80, G9CP80-2, SE9CP40, SG9CP40, SG9CP80
--------------------	--



 <p>1</p>			
<b>Part No.</b>	970232	<b>Ref. No.</b>	31614900
<b>description</b>	pasta basket L1 105mm W1 120mm H1 240mm H3 445mm stainless steel for 700 (old)		
<b>For models:</b>	CPE40, CPG40, CPG40E, CPG80, CPG80E, E9CP40, E9F15-4M, E9F15-8M, E9F18-4M, E9F18-8M, G9CP40, G9CP40-2, G9CP80, G9CP80-2, SE9CP40, SG9CP40, SG9CP80		

 <p>1</p>			
<b>Part No.</b>	970216	<b>Ref. No.</b>	22617700
<b>description</b>	pasta basket L1 295mm W1 135mm H1 160mm H3 290mm stainless steel		
<b>For models:</b>	E6CP6B, E6CP6M, E6CPM, ECRM6		

 <p>1</p>			
<b>Part No.</b>	970222	<b>Ref. No.</b>	22930100
<b>description</b>	crumb screen L 303mm W 212mm suitable for fryer		
<b>For models:</b>	E10+10MB6, E10B4		

 <p>1</p>			
<b>Part No.</b>	970219	<b>Ref. No.</b>	22714900
<b>description</b>	crumb screen L 337mm W 237mm fryer		

## crumb screens

 <p>1</p>			
<b>Part No.</b>	970227	<b>Ref. No.</b>	32714400
<b>description</b>	crumb screen L 215mm W 275mm suitable for fryer		
<b>For models:</b>	E6F10-3B, E6F10-3BS, E6F10-3M, E6F10-3MS, E6F10-6B, E6F10-6BS, E6F10-6M, E6F10-6MS, E6F8-3B, E6F8-3M, E6F8-6B, E6F8-6M, E7F10-4B, E7F10-4BS, E7F10-4M, E7F10-4MS, E7F10-8B, E7F10-8BS, E7F10-8M, E7F10-8MS, ELT10+10B, ELT10+10B-E, ELT10B, ELT10B-E, ELT12+12B, ELT12+12B-E, ELT12B, ELT12B-E, ELT15+15B, ELT15+15B-E, ELT15B, ELT15B-E, ELT18+18B, ELT18+18BE, ELT18B, ELT18BE, GL8+8B, GL8+8M, GL8B, GL8M		

 <p>1</p>			
<b>Part No.</b>	970228	<b>Ref. No.</b>	32714500
<b>description</b>	crumb screen L 336mm W 250mm suitable for fryer		
<b>For models:</b>	9GL15+15M, 9GL15M, ELT10+10B-E, ELT10B-E, ELT12+12B-E, ELT12+12M-E, ELT12B-E, ELT12M-E, ELT15+15B, ELT15+15B-E, ELT15+15M, ELT15+15M-E, ELT15B, ELT15B-E, ELT15M, ELT15M-E, ELT18+18B, ELT18+18BE, ELT18+18B-E, ELT18+18M, ELT18+18M-E, ELT18+18M-E224, ELT18B, ELT18BE, ELT18B-E, ELT18M, ELT18M-E, GL10+10B, GL10+10M, GL10B, GL10M, GL15+15M, GL15M		

## shelves and shelf rails

### chargrill grids

 <p>1</p>			
<b>Part No.</b>	211097	<b>Ref. No.</b>	31643500
<b>description</b>	chargrill grid L 525mm W 350mm H 11mm		
<b>For models:</b>	PLG40B, PLG40BE, PLG40M, PLG40ME, PLG80B, PLG80BE, PLG80M, PLG80ME		



## grates

## producer-specific



<b>Part No.</b>	970990	<b>Ref. No.</b>	24848700
<b>description</b>	grate W 600mm D 400mm H 36mm chrome-plated steel for oven wire gauge frame 7mm lengthwise wires gauge 4mm crossing wires 1		

<b>For models:</b>	E7P4+FE1, E7P4-VTR+FE1, E7P6+FE1, E7PQ4+FE1, E7PQ4+FE1+T, E7PQ6+FE1, E7PQ6+FE1+T, E9P4+FE1, E9P4P-VTR+FE1, E9P4-VTR+FE1, E9P6+FE1, E9PQ4+FE1, E9PQ4+FE1+T, E9PQ6+FE1, E9PQ6+FE1+T, G7F4+FE1, G7F4+FG1, G7F4E+FE1, G7F4E+FE1+A4, G7F4E+FG1, G7F4E+FG1+A4, G7F4P+FG1, G7F4P+FG1+AF1, G7F4PW+FE1, G7F4PW+FE1+AE, G7F4PW+FG1, G7F4PW+FG1+AE, G7F6+FE1, G7F6+FG1, G7F6E+FE1, G7F6E+FE1+A6, G7F6E+FG1, G7F6E+FG1+A4, G7F6E+FG1+A6, G7F6P+FG1, G7F6P+FG1+AF1, G7F6PW+FE1, G7F6PW+FE1+AE, G7F6PW+FG1, G7F6PW+FG1+AE, G7T4P2F+FG1, G7T4P4F+FG1, G7TP+FG1, G7TP2F+FG1, G9F4+FG1, G9F4E+FE1, G9F4E+FE1+A4, G9F4E+FG1, G9F4E+FG1+A4, G9F4P+FG1...(Other models you can see in the webshop)		
--------------------	--	--	--

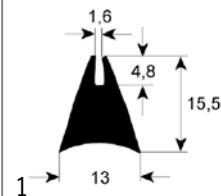

<b>Part No.</b>	900473	<b>Ref. No.</b>	23602100
<b>description</b>	window gasket profile 1650 L 2250mm Qty 1		
<b>For models:</b>	FME10, FME10EP, FME10M, FME20, FME20M, FMG10, FMG10EP, FMG10M, FMG20, FMG20M, FPE12TURBO, FPG12, MM10EA, MM10EB, MM10GA, MM10GB, WAV-E12, WAV-E12T, WAV-E12TURBO, WAV-E20, WAV-G12, WAV-G20		

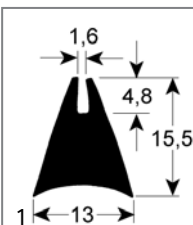

<b>Part No.</b>	900881	<b>Ref. No.</b>	N/A
<b>description</b>	window gasket profile 1650 Qty supplied by meter		

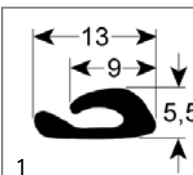

<b>Part No.</b>	900469	<b>Ref. No.</b>	14017
<b>description</b>	window gasket profile 1880 L 1385mm Qty 1		
<b>For models:</b>	FC200GB		

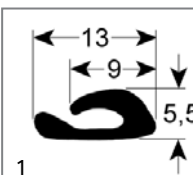

<b>Part No.</b>	900470	<b>Ref. No.</b>	14018
<b>description</b>	window gasket profile 1880 L 520mm Qty 1		
<b>For models:</b>	FC200GB		

<b>accessories for</b>	900470			
	<b>Part No.</b>	900471	<b>Ref. No.</b>	14019
	window gasket profile 1880 L 680mm Qty 1			

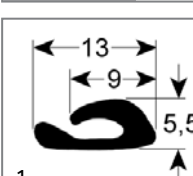

<b>Part No.</b>	900471	<b>Ref. No.</b>	14019
<b>description</b>	window gasket profile 1880 L 680mm Qty 1		
<b>accessories for</b>	900471		

	<b>Part No.</b>	900470	<b>Ref. No.</b>	14018
	window gasket profile 1880 L 520mm Qty 1			

## gaskets

## gaskets for heated units

## window seals

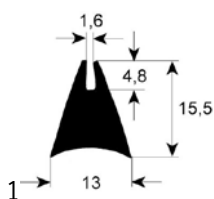

<b>Part No.</b>	900463	<b>Ref. No.</b>	25594000
<b>description</b>	window gasket profile 1650 L 1110mm Qty 1		
<b>For models:</b>	MM2-3EA, MM2-3EB		

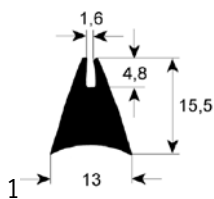

<b>Part No.</b>	900472	<b>Ref. No.</b>	23601400
<b>description</b>	window gasket profile 1650 L 1700mm Qty 1		
<b>For models:</b>	FME06M, FME6, FMG10M, FMG6, FMG6EP, FMG6M, FPE6TURBO, FPG6, MM06EA, MM06EB, MM06GA, MM06GB, WAV-E12, WAV-E5U, WAV-E6, WAV-E6T, WAV-E6TURBO, WAV-G5U, WAV-G6		

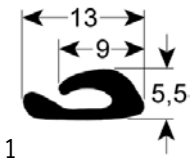

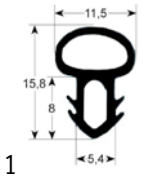

<b>Part No.</b>	900882	<b>Ref. No.</b>	14002
<b>description</b>	window gasket profile 1880 Qty supplied by meter		

**door seals**

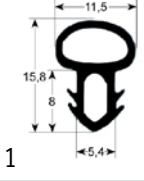

<b>Part No.</b>	900112	<b>Ref. No.</b>	31859000
<b>description</b>	door seal profile 2040 L 1800mm Qty 1		
<b>For models:</b>	E7P4+FE1, E7P4-VTR+FE, E7P4-VTR+FE1, E7P6+FE1, E7PQ4+FE+T, E7PQ4+FE1, E7PQ4+FE1+T, E7PQ6+FE+T, E7PQ6+FE1+T, E9P4+FE1, E9P4+FES, E9P4P-VTR+FE1, E9P4-VTR+FE, E9P4-VTR+FE1, E9P4-VTR+FES, E9P6+FE1, E9P6+FES, E9PQ4+FE1, E9PQ4+FE1+T, E9PQ4+FES, E9PQ6+FE1, E9PQ6+FE1+T, E9PQ6+FES, G12F4H9+FGP, G12F4P9+FGP, G6F2B, G6F2B+A2, G6F4B, G6F4B+A4, G6F6B, G6F6B+A6, G7F4+FE, G7F4+FE1, G7F4+FES, G7F4+FG, G7F4+FG1, G7F4E+FE, G7F4E+FE+A4, G7F4E+FE1, G7F4E+FE1+A4, G7F4E+FG, G7F4E+FG+A4, G7F4E+FG1, G7F4E+FG1+A4, G7F4P+FG, G7F4P+FG+AF2, G7F4P+FG1, G7F4P+FG1+AF1, G7F4PW+FG1...(Other models you can see in the webshop)		



<b>Part No.</b>	900625	<b>Ref. No.</b>	N/A
<b>description</b>	door seal profile 2040 Qty supplied by meter		

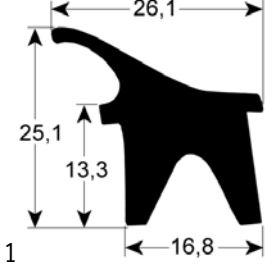

<b>Part No.</b>	900464	<b>Ref. No.</b>	23595800
<b>description</b>	door seal profile 2400 W 420mm L 645mm external size Qty 1		
<b>For models:</b>	WAV-E5U, WAV-G5U		

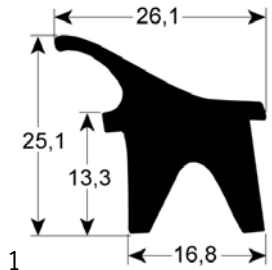

<b>Part No.</b>	900467	<b>Ref. No.</b>	23596700
<b>description</b>	door seal profile 2400 W 480mm L 650mm external size Qty 1		
<b>For models:</b>	SNACK-E, SNACK-E-LS		

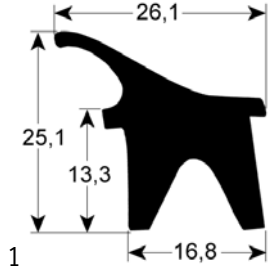

<b>Part No.</b>	900465	<b>Ref. No.</b>	23595200
<b>description</b>	door seal profile 2400 W 480mm L 700mm external size Qty 1		
<b>For models:</b>	FPE6TURBO, FPG6, WAV-E6, WAV-E6T, WAV-E6TURBO, WAV-G6		

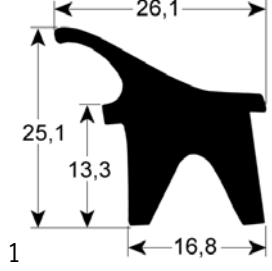

<b>Part No.</b>	900468	<b>Ref. No.</b>	23595600 25595623
<b>description</b>	door seal profile 2400 W 640mm L 800mm external size Qty 1		
<b>For models:</b>	FME10, FME10EP, FME10M, FME20, FME20M, FMG10, FMG10EP, FMG10M, FMG20, FMG20M, MM10EA, MM10EB, MM10GA, WAV-E20, WAV-G20		

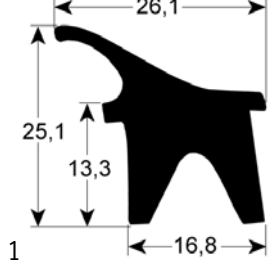

<b>Part No.</b>	900475	<b>Ref. No.</b>	14013
<b>description</b>	door seal profile 2400 W 685mm L 1465mm external size Qty 1		

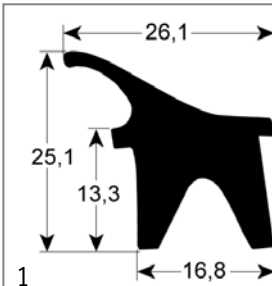
<b>Part No.</b>	900474	<b>Ref. No.</b>	14014
<b>description</b>	door seal profile 2400 W 685mm L 805mm external size Qty 1		
<b>For models:</b>	FC200GB		

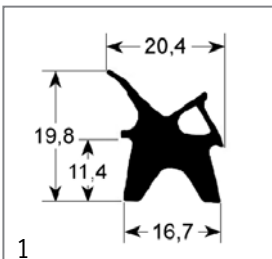

<b>Part No.</b>	900059	<b>Ref. No.</b>	23595400
<b>description</b>	door seal profile 2410 Qty supplied by meter		

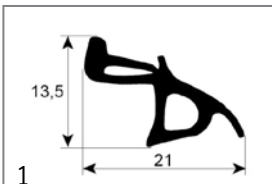

<b>Part No.</b>	900230	<b>Ref. No.</b>	22594400
<b>description</b>	door seal profile 2920 L 1400mm Qty 1		
<b>For models:</b>	E4F+FCD8, E4F+FCDQ8, G4F+FCD8, G4F+FSD8		

## door seals with fixing hook



<b>Part No.</b>	900401	<b>Ref. No.</b>	22594200
<b>description</b>	door seal L 600mm W 300mm 3-sided long side open with 5 mounting clips		
<b>For models:</b>	E7P4+FE1, E7P4-VTR+FE1, E7P6+FE1, E7PQ4+FE1, E7PQ4+FE1+T, E7PQ6+FE1, E7PQ6+FE1+T, E9P4+FE1, E9P4P-VTR+FE1, E9P4-VTR+FE1, E9P6+FE1, E9PQ4+FE1, E9PQ4+FE1+T, E9PQ6+FE1, E9PQ6+FE1+T, G4S+FCGN, G4S+FSGN, G6F2B, G6F2B+A2, G6F4+FE1, G6F4+FE1+A4, G6F4+FG1, G6F4+FG1+A4, G6F4B, G6F4B+A4, G6F6+FE1, G6F6+FE1+A6, G6F6+FG1, G6F6+FG1+A6, G6F6B, G6F6B+A6, G6S+FCGN, G6S+FSGN, G7F4+FE1, G7F4+FG1, G7F4E+FE1, G7F4E+FE1+A4, G7F4E+FG1, G7F4E+FG1+A4, G7F4P+FE1, G7F4P+FE1+T, G7F4P+FE1+A6, G7F4P+FE1+A6+T, G7F4PW+FE1, G7F4PW+FE1+T, G7F4PW+FE1+A6, G7F4PW+FE1+A6+T, G7F6+FE1, G7F6+FE1+T, G7F6+FE1+A6, G7F6+FE1+A6+T, G7F6E+FE1... (Other models you can see in the webshop)		



<b>Part No.</b>	901301	<b>Ref. No.</b>	22594300
<b>description</b>	door seal W 540mm long side open H 270mm		
<b>For models:</b>	E6P4+FE1, E6P6+FE1, E6PQ2H6+FE1, E6PQ2H6+FE1+T, E6PQ2P9+FE1, G6F2H6+FE1, G6F2H6+FG1, G6F2H9+FE1, G6F2H9+FG1, G6F-2P6+FE1, G6F2P6+FG1, G6F2P9+FE1, G6F2P9+FG1, G6F3H12+FE1, G6F3H12+FG1, G6F4+FE1, G6F4+FE1+A4, G6F4+FG1, G6F4+FG1+A4, G6F4PW+FE1, G6F4PW+FE1+AE, G6F4PW+FG1, G6F4PW+FG1+AE, G6F6+FE1, G6F6+FE1+A6, G6F6+FG1, G6F6+FG1+A6, G6F6PW+FE1, G6F6PW+FE1+AE, G6F6PW+FG1, G6F6PW+FG1+AE		

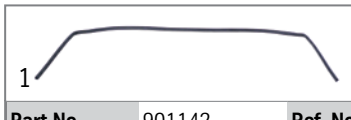

<b>Part No.</b>	901142	<b>Ref. No.</b>	36594100
<b>description</b>	door seal W 800mm with 6 mounting clips H 240mm		
<b>For models:</b>	E6P6+TE, E6PQ2P9+TE, G6F2H9+T, G6F2H9+TE, G6F2P9+T, G6F-2P9+TE, G6F3H12+T, G6F3H12+TE, G6F3H9+T, G6F6+T, G6F6+T+A6, G6F6+TE, G6F6+TE+A6, G6F6PW+T, G6F6PW+T+AE, G6F6PW+TE, G6F6PW+TE+AE		

## O-rings

## EPDM

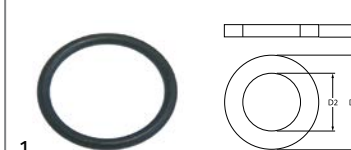

<b>Part No.</b>	510408	<b>Ref. No.</b>	35859500
<b>description</b>	O-ring EPDM thickness 5.34mm ID $\varnothing$ 47mm Qty 1 pcs		
<b>For models:</b>	E9P10I, E9P10IA, E9P15I, E9P15IA, SE9P10I, SE9P10IA, SE9P15I, SE9P15IA		

## Viton



<b>Part No.</b>	529186	<b>Ref. No.</b>	45354800 45854800
<b>description</b>	O-ring Viton thickness 3.53mm ID $\varnothing$ 47.63mm Qty 1 pcs		
<b>For models:</b>	E9F15-4M, E9F15-8M, E9F18-4M, E9F18-8M		



<b>Part No.</b>	510245	<b>Ref. No.</b>	22014800
<b>description</b>	O-ring Viton thickness 3.53mm ID $\varnothing$ 50.8mm Qty 1 pcs		



<b>Part No.</b>	510243	<b>Ref. No.</b>	22015000
<b>description</b>	O-ring Viton thickness 3.53mm ID ø 55.56mm Qty 1 pcs		

**miscellaneous**

<b>Part No.</b>	519639	<b>Ref. No.</b>	35859400
<b>description</b>	O-ring thickness 5.5mm ID ø 53mm Qty 1 pcs grey		
<b>For models:</b>	E9P10D, E9P15D		

**sealing washers**

**silicone gaskets**

<b>Part No.</b>	542448	<b>Ref. No.</b>	35859800
<b>description</b>	gasket silicone 60x49x2 for drain tap 2"		
<b>For models:</b>	E9P10D, E9P10I, E9P10IA, E9P15D, E9P15I, E9P15IA, G9P10D, G9P10DA, G9P10I, G9P10IA, G9P15D, G9P15DA, G9P15I, G9P15IA, LXE9P15I, SE9P10I, SE9P10IA, SE9P15I, SE9P15IA, SG9P10D, SG9P10DA, SG9P10I, SG9P10IA, SG9P15D, SG9P15DA, SG9P15I		

<b>Part No.</b>	359721	<b>Ref. No.</b>	23602800
<b>description</b>	gasket silicone ED ø 48mm ID ø 39.5mm thickness 5mm Qty 1 pcs		
<b>For models:</b>	FC100EM, FC100EP, FC100GEP, FC100GM, FC200EA, FC200EB, FC-200GA, FC200GB, FC60EM, FC60EP, FC60GEP, FC60GM, FPE12TURBO, FPE6TURBO, FPG12, FPG6, WAV-E12, WAV-E12T, WAV-E12TURBO, WAVE5U, WAV-E6, WAV-E6T, WAV-E6TURBO, WAV-G12, WAV-G5U, WAV-G6		

**sealing cords**

**flat**

<b>Part No.</b>	699208	<b>Ref. No.</b>	31858600
<b>description</b>	sealing cord glass fibre size 5x26mm L 1325m		
<b>For models:</b>	E7P4+FE, E7P4-VTR+FE, E7P6+FE, E7PQ4+FE, E7TP+FE, E9P4+FE, E9P4-VTR+FE, E9P6+FE, E9PQ4+FE, G7F4+FE, G7F4+FG, G7F4E+FE, G7F4E+FG, G7F4P+FG, G7F6+T, G7T4P4F+FG, G7TP+FG, G7TP2F+FG, G9F4+FE, G9F4+FG, G9F4P+FG, G9F4P+FG+AF2, G9F4PW+FG, G9F-4PW+FG+AE, G9F6+FG, G9F6P+FG, G9F6P+FG+AF2, G9F6PW+FG, G9F6PW+FG+AE, G9F8+2FE, G9F8+2FG, G9F8P+2FG, G9F8P+2FG+AF2, G9TP+FG, G9TP2F+FG, SE9PQ4+FE, SG9TP2F+FG		

**springs**

**torsion springs**

<b>Part No.</b>	693299	<b>Ref. No.</b>	31878200
<b>description</b>	torsion spring ø 28.6mm L2 103mm wire gauge ø 3.6mm L1 45mm		
<b>For models:</b>	E7PI, G7PD, G7PI		

**compression springs**

<b>Part No.</b>	101446	<b>Ref. No.</b>	31878600
<b>description</b>	compression spring ø 11mm L 6mm wire gauge ø 1.2mm		
<b>For models:</b>	G7F2BE+A2, G7F2ME+A2, G7F4BE+A4, G7F4E+FE+A4, G7F4E+FE1+A4, G7F4E+FG+A4, G7F4E+FG1+A4, G7F4ME+A4, G7F6BE+A6, G7F6E+FE+A6, G7F6E+FE1+A6, G7F6E+FG+A4, G7F6E+FG1+A4, G7F6E+FG1+A6, G7F6E+T, G7F6ME+A6, G9F2ME, G9F2ME+A2, G9F4ME, G9F4ME+A4, G9F6E+FE1+A6, G9F6E+FG1+A6, G9F6ME, G9F6ME+A6		

**manometers**

<b>Part No.</b>	541062	<b>Ref. No.</b>	31875700	
<b>description</b>	manometer ø 63mm pressure range 0 up to 1bar connection marking adjustable kettle thread 1/4"			
<b>For models:</b>	E7PI, E9P10I, E9P10IA, E9P15I, E9P15IA, G7PI, G9P10I, G9P10IA, G9P15I, G9P15IA, LXG9P15I, SE9P10I, SE9P10IA, SE9P15I, SE9P15IA, SG9P10I, SG9P10IA, SG9P15I			
<b>spare parts for</b>	541062			
	<b>Part No.</b>	541130	<b>Ref. No.</b>	—
		glass panel ø 58mm thickness 2mm		



## valves and tank inlets

## ball valves

universal

ball valves with butterfly handle



1

<b>Part No.</b>	540658	<b>Ref. No.</b>	32686300 32686900
<b>description</b>	ball valve connection 3/4" IT - 3/4" IT DN20 total length 69mm		
<b>For models:</b>	9GL15+15M, 9GL15M, 9GL20+20M, 9GL20M, CPE40, CPG40, CPG40E, CPG80, CPG80E, E6F8-3M, E6F8-6M, E7F10-4B, E7F10-4BS, E7F10-4M, E7F10-4MS, E7F10-8B, E7F10-8BS, E7F10-8M, E7F10-8MS, E7F18-4M, E7F18-4MS, E7F18-8M, E7F18-8MS, E7F30-8M, E7F30-8MP, E9F15-4M, E9F15-8M, E9F18-4M, E9F18-8M, ELT12+12M, ELT12+12M-E, ELT12M, ELT12M-E, ELT15+15M, ELT15+15M-E, ELT15M, ELT15M-E, ELT18+18M, ELT18+18M-E, ELT18+18M-E224, ELT18M, ELT18M-E, ELT30M, G6CP6, G9BM4M, G9CP40, G9CP40-2, G9CP80, G9CP80-2, GL10+10M...(Other models you can see in the webshop)		

## producer-specific

## BERTO'S



1

<b>Part No.</b>	540658	<b>Ref. No.</b>	32686300 32686900
<b>description</b>	ball valve connection 3/4" IT - 3/4" IT DN20 total length 69mm		
<b>For models:</b>	9GL15+15M, 9GL15M, 9GL20+20M, 9GL20M, CPE40, CPG40, CPG40E, CPG80, CPG80E, E6F8-3M, E6F8-6M, E7F10-4B, E7F10-4BS, E7F10-4M, E7F10-4MS, E7F10-8B, E7F10-8BS, E7F10-8M, E7F10-8MS, E7F18-4M, E7F18-4MS, E7F18-8M, E7F18-8MS, E7F30-8M, E7F30-8MP, E9F15-4M, E9F15-8M, E9F18-4M, E9F18-8M, ELT12+12M, ELT12+12M-E, ELT12M, ELT12M-E, ELT15+15M, ELT15+15M-E, ELT15M, ELT15M-E, ELT18+18M, ELT18+18M-E, ELT18+18M-E224, ELT18M, ELT18M-E, ELT30M, G6CP6, G9BM4M, G9CP40, G9CP40-2, G9CP80, G9CP80-2, GL10+10M...(Other models you can see in the webshop)		



1

<b>Part No.</b>	514280	<b>Ref. No.</b>	32696300
<b>description</b>	extension ball valve		
<b>For models:</b>	GL15+15M, GL15M, GL20+20M, GL20M		

## ball valves electric



1

<b>Part No.</b>	401233	<b>Ref. No.</b>	10036
<b>description</b>	ball valve inlet 1/2" IT outlet 1/2" IT 230V 50/60Hz mode of operation electric W 60mm H 99mm cable 4-pole 2.5W 4-pole duty cycle 50%		

## shut-off valves

universal



1

<b>Part No.</b>	514374	<b>Ref. No.</b>	31686800 31686800+31924800
<b>description</b>	shut-off valve connection 1/2" 1/2" cold		
<b>For models:</b>	CPE40, CPG40, CPG40E, CPG80, CPG80E, E6CP3B, E6CP6B, E6CP6M, E6CPM, E6PL60B, E6PL60M, E9BR8, E9BR8-I, E9CP40, E9F15-4M, E9F15-8M, E9F18-4M, E9F18-8M, E9PL40M, E9PL80M, G6CP6, G9BM4M, G9BR8, G9BR8-I, G9CP40, G9CP40-2, G9CP80, G9CP80-2, LXE9BR8-I, LXG9BR8-I, PLE40BE, PLE40ME, PLE80BE, PLE80ME, SE9BM4M, SE9BM8M, SE9BR8, SE9BR8-I, SE9CP40, SE9PL40M, SE9PL80M, SG9BM4M, SG9BR8, SG9BR8-I, SG9CP40, SG9CP80		

## fastening material

## nuts

## hexagonal nuts

## hexagonal nuts metric (without norm)



1

<b>Part No.</b>	107934	<b>Ref. No.</b>	32811500
<b>description</b>	nut H 5mm thread M14x1 WS 17		
<b>For models:</b>	G6F2B, G6F2B+A2, G6F2H6+FE1, G6F2H6+FG1, G6F2P6+FE1, G6F-2P6+FG1, G6F4B, G6F4B+A4, G6F6B, G6F6B+A6, G7F2BP, G7F2MP, G7F4BP, G7F4MP, G7F4P+FG, G7F4P+FG+AF2, G7F4P+FG1, G7F4P+FG1+AF1, G7F6BP, G7F6MP, G7F6P+FG, G7F6P+FG+AF2, G7F6P+FG1, G7F6P+FG1+AF1, G7F6P+T, G7F6P+T+AF2, G7T4P2F+FG1, G7T4P2FB, G7T4P2FM, G7T4P4F+FG, G7T4P4F+FG1, G7T4P4FB, G7T4P4FM, G7TP+FG, G7TP2F+FG, G7TP2F+FG1, G7TP2F+T, G7TP2FM, G9F2MP, G9F4MP, G9F4P+FG, G9F4P+FG+AF2, G9F4P+FG1, G9F4P+FG1+AF1, G9F4PW+FG+AE, G9F6MP, G9F6P+FG, G9F6P+FG1, G9F6P+T, G9F-6P+T+AF2...(Other models you can see in the webshop)		



			
1			
<b>Part No.</b>	102680	<b>Ref. No.</b>	31807600
<b>description</b>	nut thread M6x0.75 H 2.6mm WS 8 brass Qty 1 pcs type SEF 2		
<b>For models:</b>	G6F2B, G6F2B+A2, G6F2M, G6F2M+A2, G6F4+FE1, G6F4+FE1+A4, G6F4+FG1, G6F4+FG1+A4, G6F4B, G6F4B+A4, G6F4M, G6F4M+A4, G6F6+FE1, G6F6+FE1+A6, G6F6+FG1, G6F6+FG1+A6, G6F6+T, G6F6+T+A6, G6F6+TE, G6F6+TE+A6, G6F6B, G6F6B+A6, G6F6M, G6F6M+A6, G7F2BE, G7F2BE+A2, G7F2ME, G7F2ME+A2, G7F4BE, G7F4BE+A4, G7F4E+FE, G7F4E+FE+A4, G7F4E+FE1, G7F4E+FE1+A4, G7F4E+FG, G7F4E+FG+A4, G7F4E+FG1, G7F4E+FG1+A4, G7F4ME, G7F4ME+A4, G7F6BE, G7F6BE+A6, G7F6E+FE, G7F6E+FE+A6, G7F6E+FE1, G7F6E+FE1+A6, G7F6E+FG, G7F6E+FG+A4, G7F6E+FG+A6, G7F6E+FG1...(Other models you can see in the webshop)		

			
1			
<b>Part No.</b>	102067	<b>Ref. No.</b>	22290900
<b>description</b>	nut thread M8x1 H 3mm brass Qty 1 pcs type SEF 1		
<b>For models:</b>	G2FS4, G4F+FCD8, G4F+FSD8, G4FD8, G6F2H6+FG1, G6F2P6+FG1, G6F4+FG1, G6F4+FG1+A4, G6F4PW+FG1, G6F4PW+FG1+AE, G6F6+FG1, G6F6+FG1+A6, G6F6PW+FG1, G6F6PW+FG1+AE, G7F4+FG1, G7F4E+FG1, G7F4E+FG1+A4, G7F4P+FG1, G7F4P+F G1+AF1, G7F4PW+FG1, G7F4PW+FG1+AE, G7F6+FG1, G7F6E+FG1, G7F6E+FG1+A4, G7F6E+FG1+A6, G7F6P+FG1, G7F6P+FG1+AF1, G7F6PW+FG1, G7F6PW+FG1+AE, G7T4P2F+FG1, G7T4P4F+FG1, G7TP+FG1, G7TP2F+FG1, G9F4+FG1, G9F4E+FG1, G9F4E+FG1+A4, G9F4P+FG1, G9F4P+FG1+AF1, G9F4PW+FG1, G9F4PW+FG1+AE, G9F6+FG1, G9F6E+FG1, G9F6E+FG1+A6, G9F6P+FG1, G9F6PW+FG1, G9F6PW+FG1+AE, G9F8+2FG1, G9F8P+2FG1, G9TP+FG1, G9T P2F+FG1		

## consumables

### sealants and adhesives

#### high temperature silicone

			
1			
<b>Part No.</b>	890050	<b>Ref. No.</b>	30951000
<b>description</b>	high temperature silicone NOVASIL S76 acetoxycuring -40 up to +265°C t.max. 280°C anthracite cartridge 310ml		
<b>description</b>	Novasil S56 - cartridge 310ml - anthracite - Developed for applications in the home appliance industry: - Gluing of oven door seals - Gluing of mounting brackets for cooker fascias, oven door seals and handles - Attachment of elastic seals, e.g. to oven doors Temperature resistance: -40°C to +265°C		



**GASTRO**PARTS.COM

